

D7056KIT – D7056KITK

SCHERMO SPECIFICO – SPECIFIC SCREEN – ÉCRAN SPECIFIQUE – SPEZIFISCHEN BLIDSCHIRM – PANTALLA ESPECIFICA – TELA ESPECIFICA

SYM CRUISYM 300 (2017/2018)

N°	Descrizione	Caratteristiche	Codice	Quantità
1	Schermo Specifico - Specific Screen Écran Spécifique - Spezifischen Bildschirm Pantalla Especifica - Tela Especifica	-	7056DT	-
2	Vite - Screw Vis - Schraube Tornillo - Parafuso	TBEI M6x55	655TBEI	2
3	Vite - Screw Vis - Schraube Tornillo - Parafuso	TBEI M6x50	650TBEI	2
4	Distanziale - Spacer Entretoise - Distanzstueck Distanciador - Espaçador	Ø18x24 Foro 8,5	C18L24F8,5T	4
5	Gommino - Fairleader Chaumard - Gummi Goma - Borracha	-	Z268	4
6	Boccola Di Ritenzione - Plastic Bush Douille Plastique - Plastik Buchse Casquillo - Boné	-	Z871N	4
7	Componenti Originali - Original Parts Parties Originales - Original Bauteile Componentes Originales - Componentes Originais	-	-	-

D7056KIT - D7056KITK

SCHERMO SPECIFICO – SPECIFIC SCREEN – ÉCRAN SPECIFIQUE – SPEZIFISCHEN BLIDSCHIRM – PANTALLA ESPECIFICA – TELA ESPECIFICA

SYM CRUISYM 300 (2017/2018)

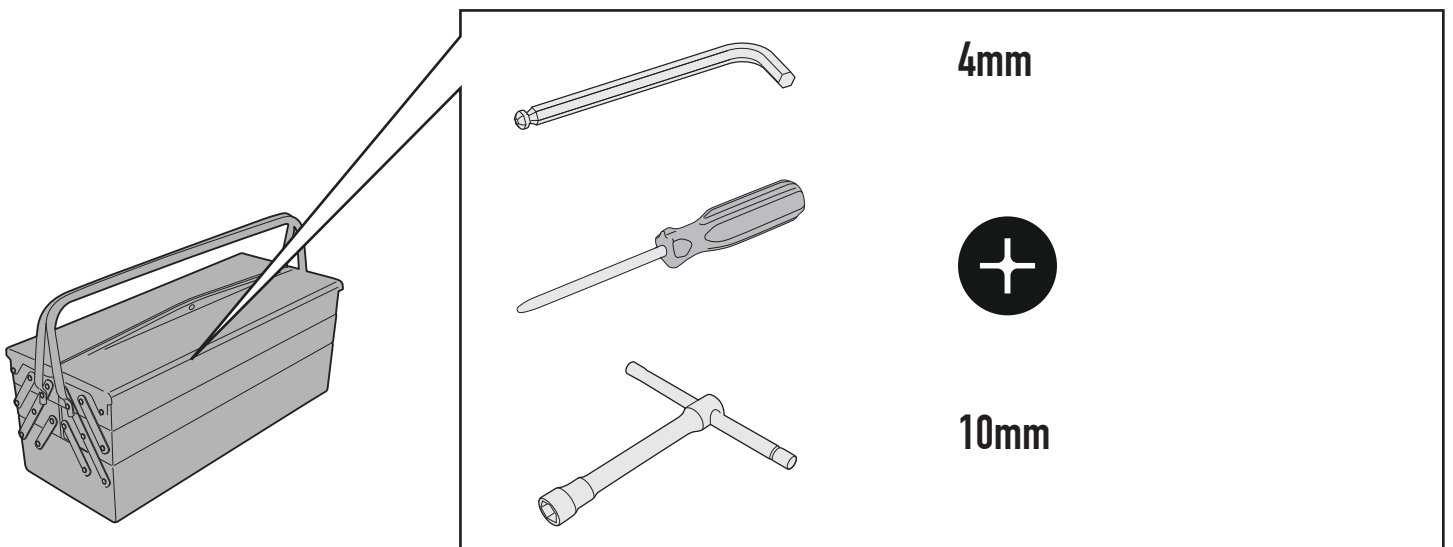
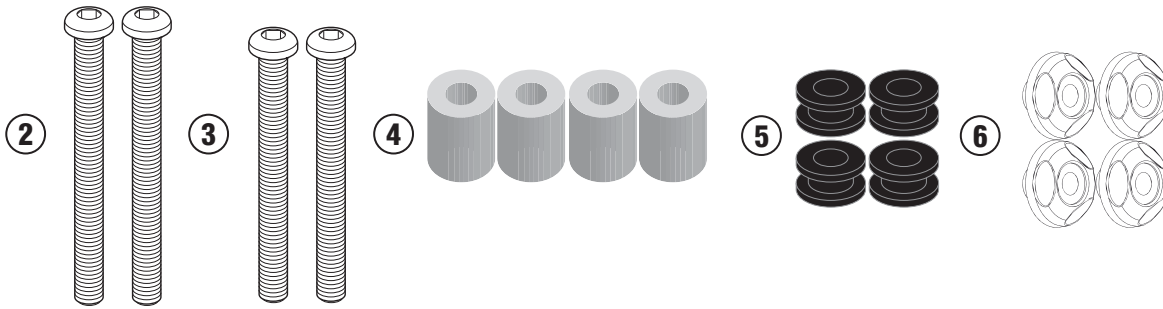

D7056KIT - D7056KITK

SCHERMO SPECIFICO - SPECIFIC SCREEN - ÉCRAN SPECIFIQUE - SPEZIFISCHEN BLIDSCHIRM - PANTALLA ESPECIFICA - TELA ESPECIFICA

SYM CRUISYM 300 (2017/2018)

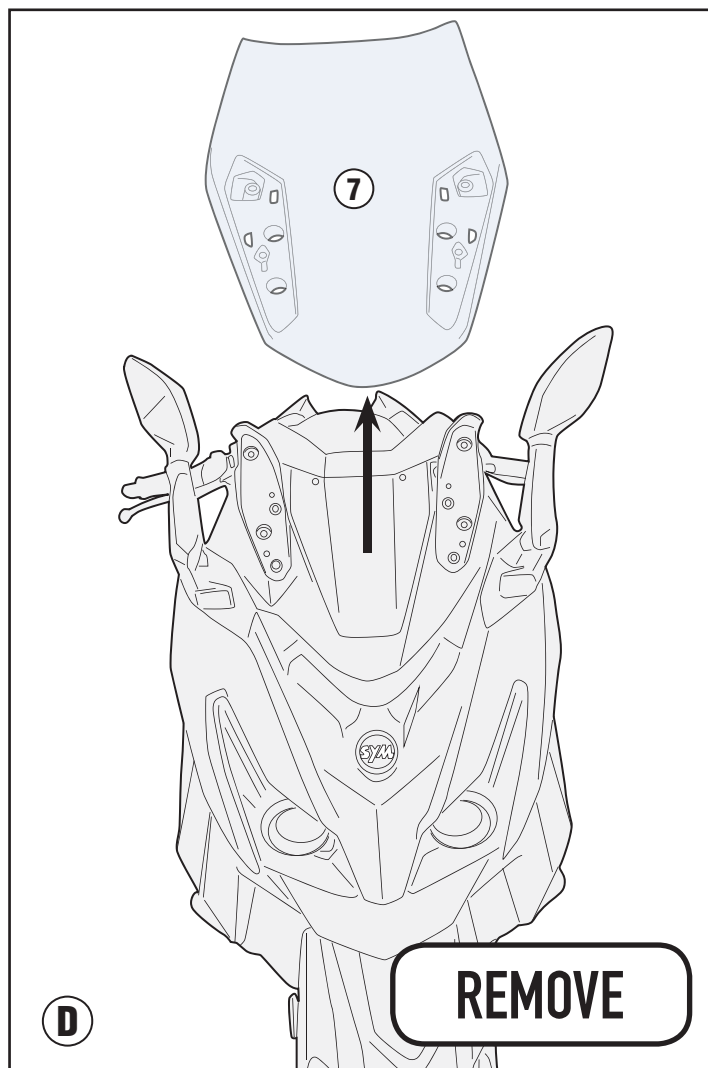
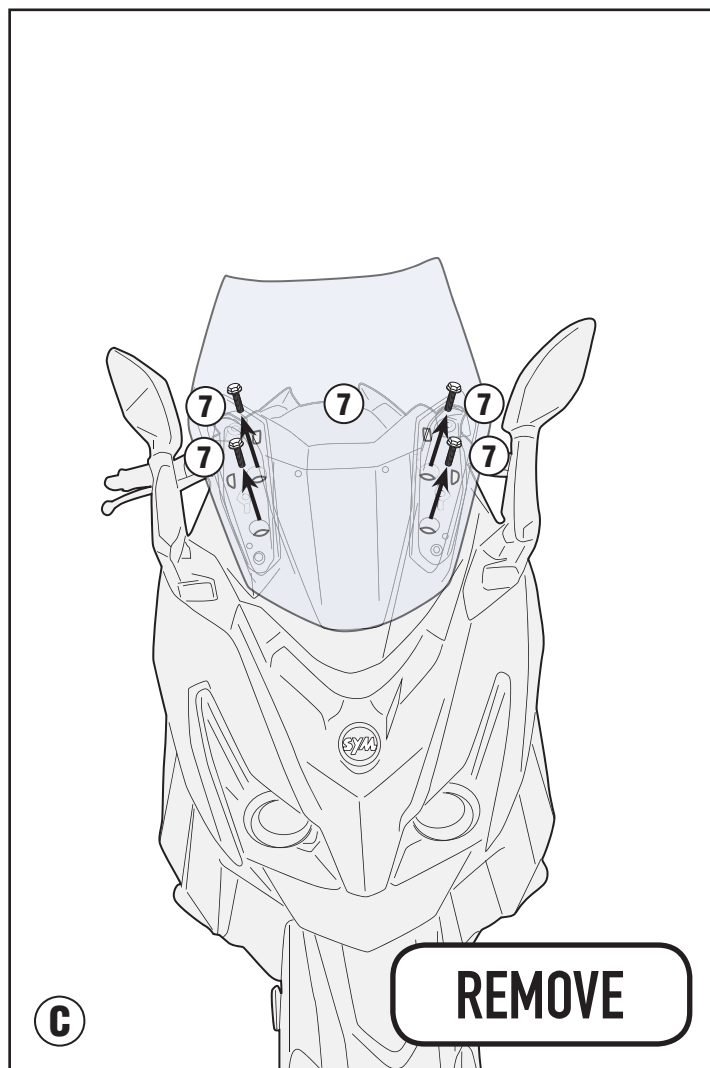
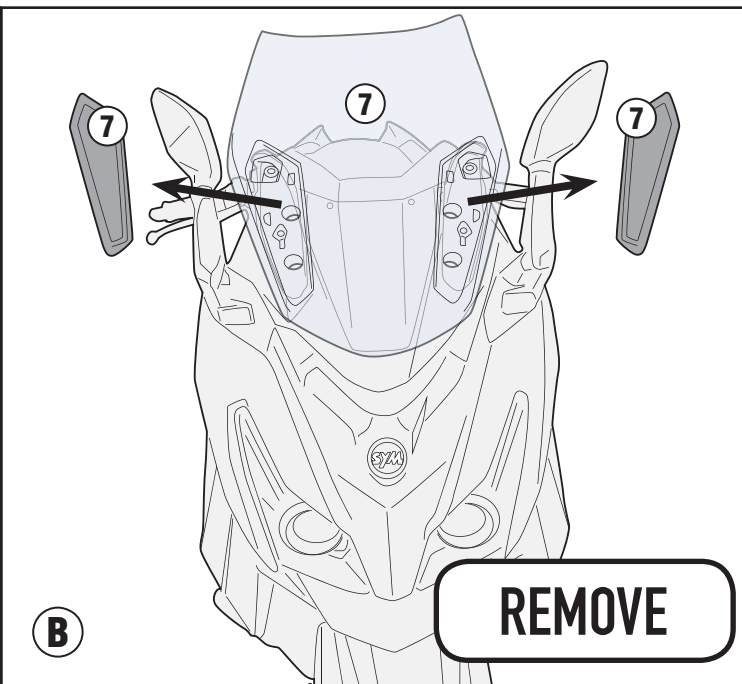
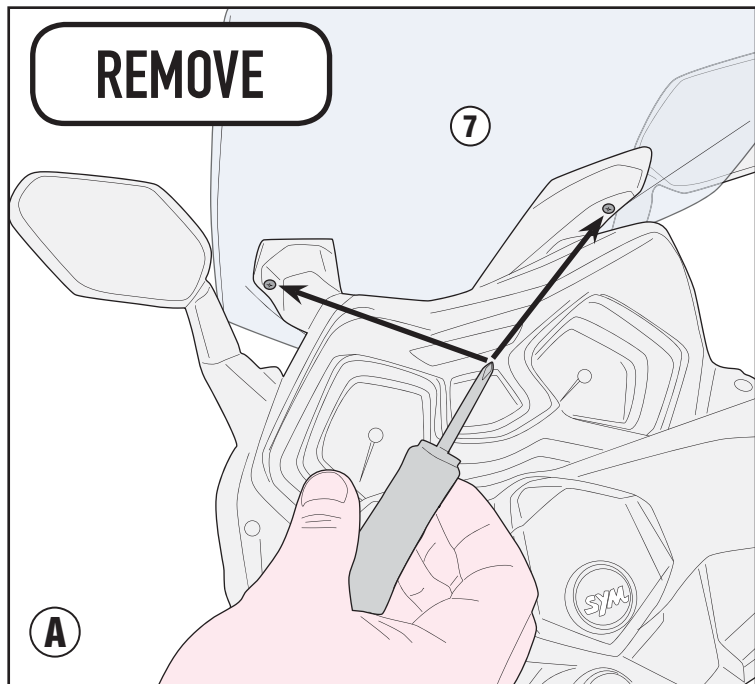

D7056KIT - D7056KITK

SCHERMO SPECIFICO - SPECIFIC SCREEN - ÉCRAN SPECIFIQUE - SPEZIFISCHEN BLIDSCHIRM - PANTALLA ESPECIFICA - TELA ESPECIFICA

SYM CRUISYM 300 (2017/2018)

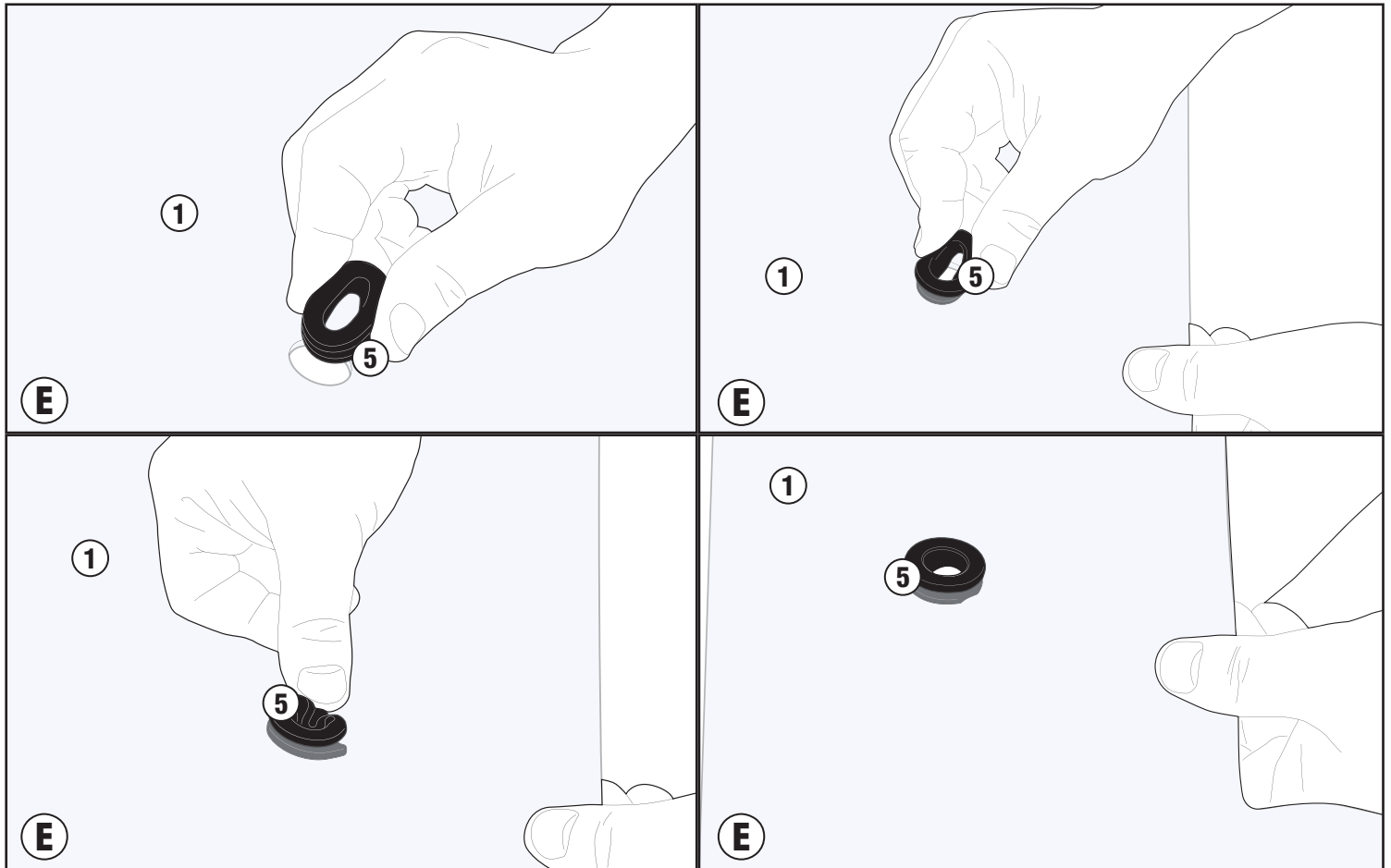
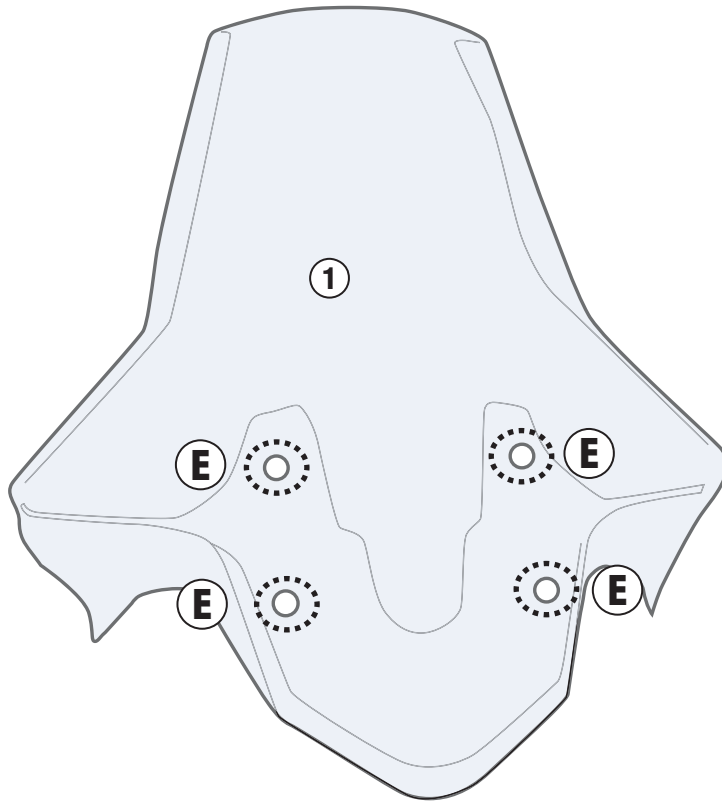

D7056KIT - D7056KITK

SCHERMO SPECIFICO – SPECIFIC SCREEN – ÉCRAN SPECIFIQUE – SPEZIFISCHEN BLIDSCHIRM – PANTALLA ESPECIFICA – TELA ESPECIFICA

SYM CRUISYM 300 (2017/2018)

