

# BF02-BF02K

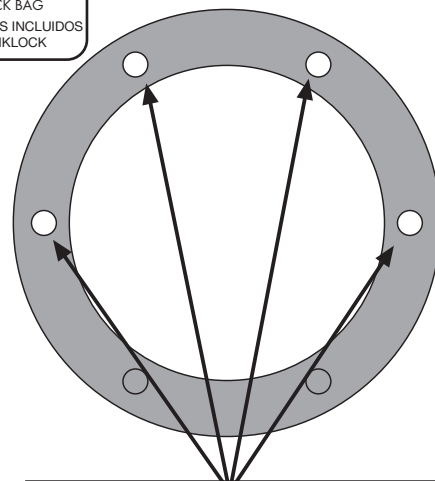

Rimuovere le viti originali  
Remove the original screws  
Enlevez les vis originales  
Entfernen Sie die Originalschrauben  
Mover los tornillos originales  
Remover os parafusos originais

- In base al numero e alle posizioni di viti originali corte e lunghe, che si trovano sul modello di moto sul quale si sta montando la flangia, seguire il montaggio raffigurato in fig.A o in fig.B
- According to the number and positions of the short and long original screws founded on the motorcycle model on which the flange will be mounted, follow the assembly shown in fig.A or fig.B
- En fonction du nombre et de la position des vis d'origine courtes et longues, qui se trouvent sur le modèle de moto sur lequel la bride sera montée, suivez le montage illustré sur la figure A ou la figure B
- Según el número y a las posiciones de los tornillos originales cortos y largos, que dispone el modelo de moto donde se montara el adaptador metálico, sigue el montaje mostrado en la figura A o en la figura B
- Je nach Anzahl und Position der originalen kurzen und langen Schrauben am Motorradmodell, an dem der Ring montiert wird, ist die in Abb. A oder Abb. B gezeigte Montage zu befolgen.
- De acordo com a quantidade e as posições dos parafusos originais curtos e longos que se encontram no modelo da motocicleta na qual o flange está sendo montado, siga a montagem mostrada na fig.A ou fig.B

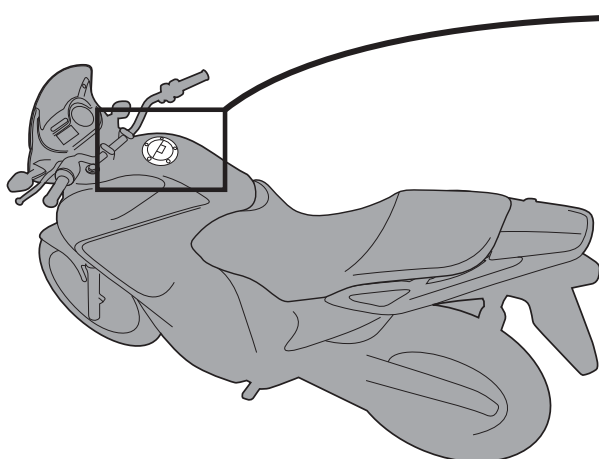
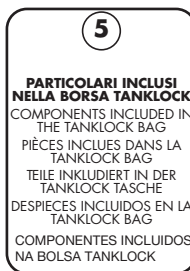
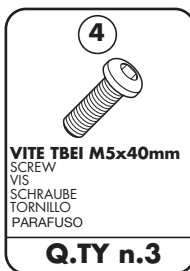
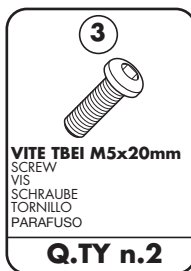
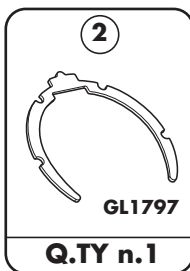
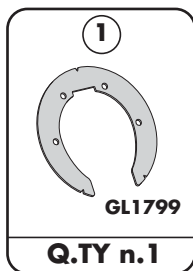