

ATTACCHI SPECIFICI PER - SPECIFIC FITTING KIT FOR  
 KIT DE MONTAGE SPECIFIQUE POUR - SPEZIFISCHER MONTAGEKIT FÜR  
 ANCLAJE ESPECIFICO PARA

# SYM FIDDLE II 50-125cc 2009

ISTRUZIONI DI MONTAGGIO - MOUNTING INSTRUCTIONS  
 INSTRUCTIONS DE MONTAGE - BAUANLEITUNG - INSTRUCCIONES DE MONTAJE

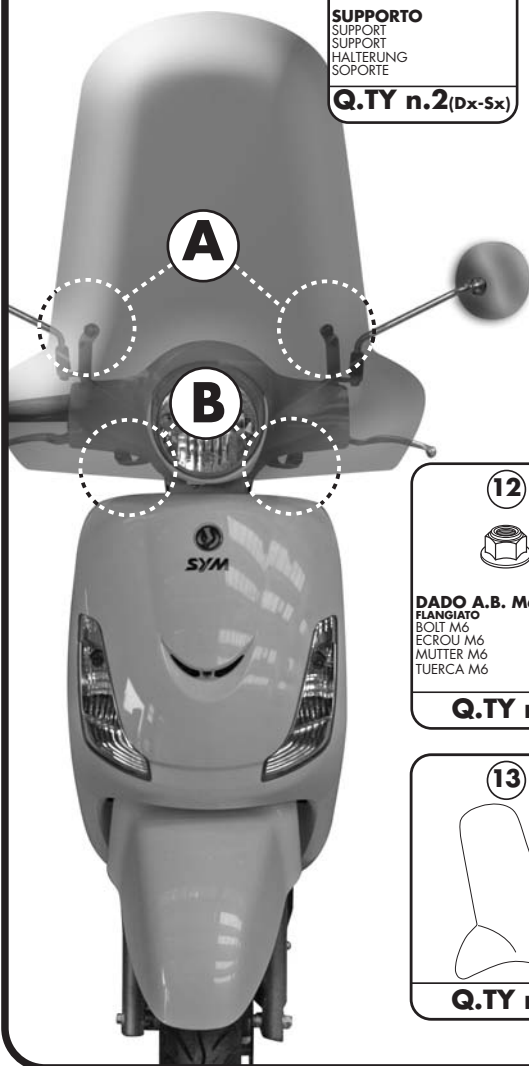

**3**



**SUPPORTO**  
 SUPPORT  
 SUPPORT  
 HALTERUNG  
 SOPORTE

**Q.TY n.2(Dx-Sx)**

**4**



**VITE TEF M8x50mm**  
 SCREW  
 VIS  
 SCHRAUBE  
 TORNILLO

**Q.TY n.2**

**5**



**VITE TEF M8x30mm**  
 SCREW  
 VIS  
 SCHRAUBE  
 TORNILLO

**Q.TY n.2**

**6**



**VITE TBEI M6x25mm**  
 SCREW  
 VIS  
 SCHRAUBE  
 TORNILLO

**Q.TY n.4**

**7**



**GOMMINO**  
 Z286  
 FAIRLEADER  
 CHAUMARD  
 GUMMI  
 GOMA

**Q.TY n.4**

**8**



**BOCCOLA DI RITENZIONE** z871N  
 PLASTIC BUSH  
 DOUILLE PLASTIQUE  
 PLASTIK BÜCHSE  
 CASQUILLO

**Q.TY n.4**

**9**



**DISTANZIALE Ø14x12mm**  
 Foro Ø8,5mm, V005  
 SPACER  
 ENTRETÔISE  
 DISTANZSTÜCK  
 DISTANCIADOR

**Q.TY n.2**

**10**



**DISTANZIALE Ø14x37mm**  
 V612  
 SPACER  
 ENTRETÔISE  
 DISTANZSTÜCK  
 DISTANCIADOR

**Q.TY n.2**

**11**



**DADO A.B. M8**  
 FLANGIATO  
 BOLT M8  
 ECROU M8  
 MUTTER M8  
 TUERCA M8

**Q.TY n.2**

**12**



**DADO A.B. M6**  
 FLANGIATO  
 BOLT M6  
 ECROU M6  
 MUTTER M6  
 TUERCA M6

**Q.TY n.4**

**13**

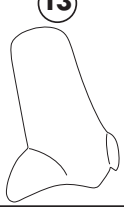

**Q.TY n.-**

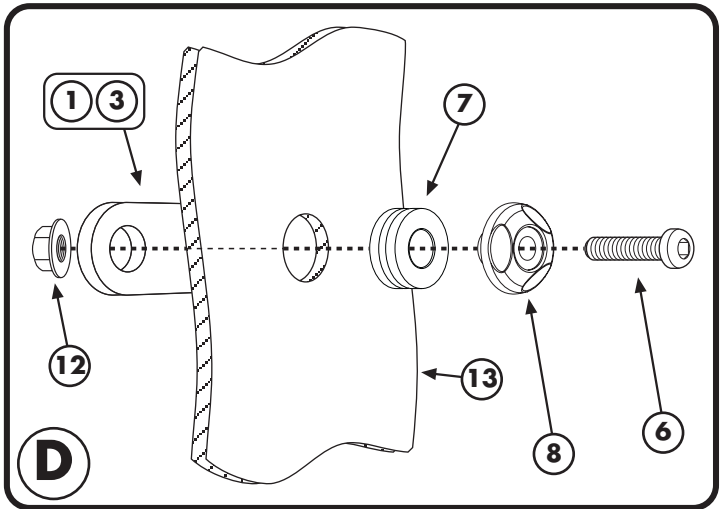

**1**



**SUPPORTO**  
 SUPPORT  
 SUPPORT  
 HALTERUNG  
 SOPORTE

**Q.TY n.2(Dx-Sx)**

**2**



**SUPPORTO**  
 SUPPORT  
 SUPPORT  
 HALTERUNG  
 SOPORTE

**Q.TY n.2**

