

ATTACCHI SPECIFICI PER - SPECIFIC FITTING KIT FOR
KIT DE MONTAGE SPECIFIQUE POUR - SPEZIFISCHER MONTAGEKIT FÜR
ANCLAJE ESPECÍFICO PARA

APRILIA SCARABEO 125-200cc
2007-2011

ISTRUZIONI DI MONTAGGIO - MOUNTING INSTRUCTIONS
INSTRUCTIONS DE MONTAGE - BAUANLEITUNG - INSTRUCCIONES DE MONTAJE

1° Modello
1° Model
1° Modèle
1° Modell
1° Modelo



Montaggio
Assembly
Assemblée
Montage
Asamblea

_A + 154A

2° Modello
2° Model
2° Modèle
2° Modell
2° Modelo



Montaggio
Assembly
Assemblée
Montage
Asamblea

_B + 154A

3° Modello
3° Model
3° Modèle
3° Modell
3° Modelo



Montaggio
Assembly
Assemblée
Montage
Asamblea

_B + 1000A

1



SUPPORTO
SUPPORT
SUPPORT
HALTERUNG
SOPORTE

Q.TY n.2(Dx-Sx)

2



SUPPORTO
SUPPORT
SUPPORT
HALTERUNG
SOPORTE

Q.TY n.2(Dx-Sx)

3

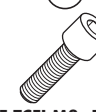

VITE TCEI M8x120mm
SCREW
VIS
SCHRAUBE
TORNILLO

Q.TY n.2

4



VITE TBEI M6x25mm
SCREW
VIS
SCHRAUBE
TORNILLO

Q.TY n.4

5



DISTANZIALE tubetto
12x26 sp. 2mm, V601
SPACER
ENTRETOISE
DISTANZSTÜCK
DISTANCIADOR

Q.TY n.2

6



DADO A.B. M8
FLANGIATO
BOLT M8
ECROU M8
MUTTER M8
TUERCA M8

Q.TY n.2

7



DISTANZIALE Ø16x4mm
Foro Ø8, V004
SPACER
ENTRETOISE
DISTANZSTÜCK
DISTANCIADOR

Q.TY n.2

8



BOCCOLA DI RITENZIONE
Z871N
PLASTIC BUSH
DOUILLE PLASTIQUE
PLASTIK BUCHSE
CASQUILLO

Q.TY n.4

9

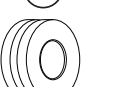

GOMMINO
Z268
FAIRLEADER
CHAUMARD
GUMMI
GOMA

Q.TY n.4

10



DADO A.B. M6
FLANGIATO
BOLT M6
ECROU M6
MUTTER M6
TUERCA M6

Q.TY n.4

11



Z1908D
GUARNIZIONE (430mm)
SEAL
JOINT
DICHTUNG
EMBELLEDOR

Q.TY n.1

12



SUPPORTO
SUPPORT
SUPPORT
HALTERUNG
SOPORTE

Q.TY n.2(Dx-Sx)

13



DADO Ø10 A.B.
passo 1,25
BOLT
ECROU
MUTTER
TUERCA

Q.TY n.1

14



DADO Ø10 A.B.
passo 1,25 Sx
BOLT
ECROU
MUTTER
TUERCA

Q.TY n.1

15



VITE TEF M8x55mm
SCREW
VIS
SCHRAUBE
TORNILLO

Q.TY n.2

16



DISTANZIALE Ø18x20mm
Foro Ø8,5mm, V559
SPACER
ENTRETOISE
DISTANZSTÜCK
DISTANCIADOR

Q.TY n.2

17



DADO A.B. RIB. M8
BOLT M8
ECROU M8
MUTTER M8
TUERCA M8

Q.TY n.2

18

COMPONENTI ORIGINALI
ORIGINAL PARTS
PARTIES ORIGINALES
ORIGINAL BAUTEILE
COMPONENTES ORIGINALES

Q.TY n.-

19

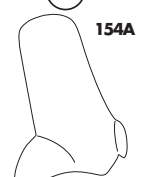

Q.TY n.-

20

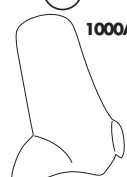

Q.TY n.-

ATTACCHI SPECIFICI PER - SPECIFIC FITTING KIT FOR
KIT DE MONTAGE SPECIFIQUE POUR - SPEZIFISCHER MONTAGEKIT FÜR
ANCLAJE ESPECIFICO PARA

APRILIA SCARABEO 125-200cc
2007-2011

ISTRUZIONI DI MONTAGGIO - MOUNTING INSTRUCTIONS
INSTRUCCIONES DE MONTAJE - BAUANLEITUNG - INSTRUCCIONES DE MONTAJE

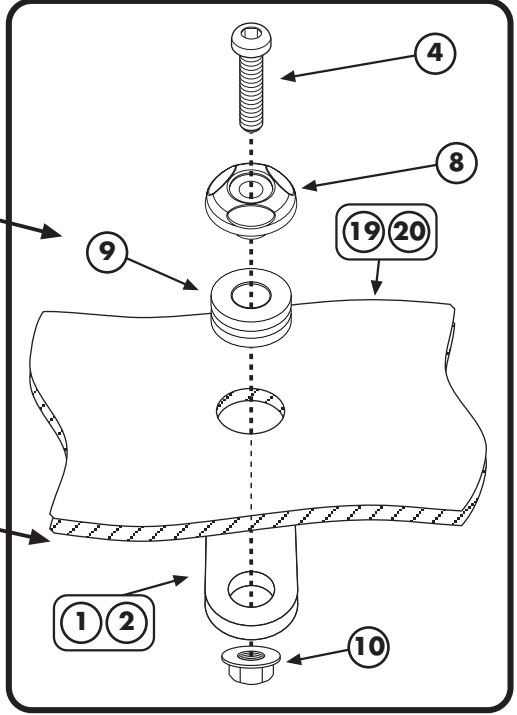
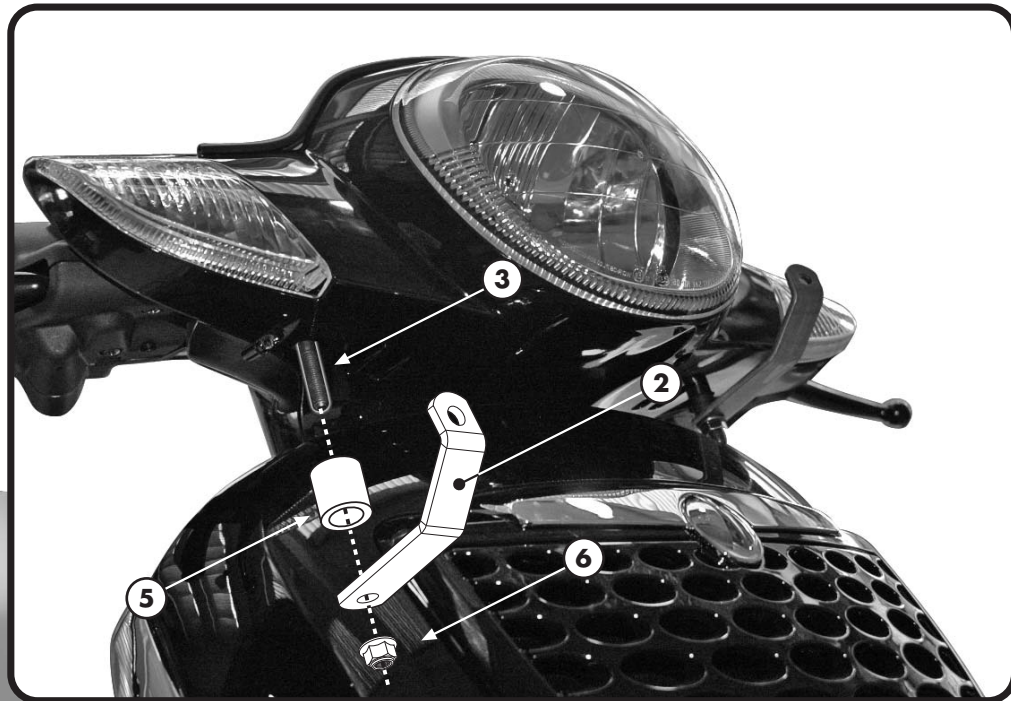
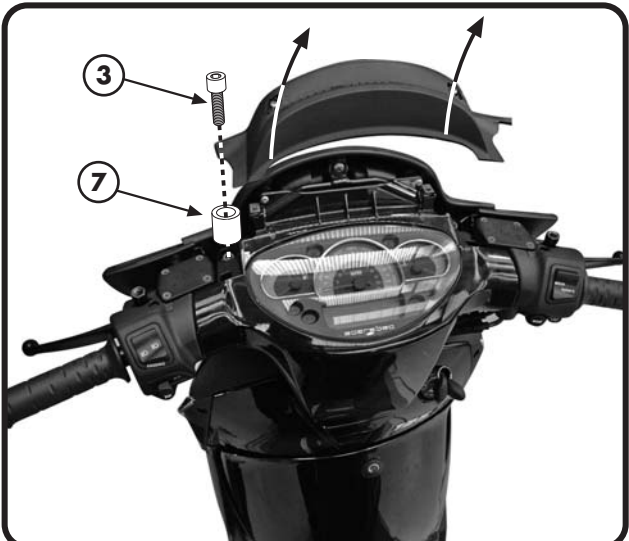

ATTACCHI SPECIFICI PER - SPECIFIC FITTING KIT FOR
 KIT DE MONTAGE SPECIFIQUE POUR - SPEZIFISCHER MONTAGEKIT FÜR
 ANCLAJE ESPECÍFICO PARA

APRILIA SCARABEO 125-200cc
 2007-2011

ISTRUZIONI DI MONTAGGIO - MOUNTING INSTRUCTIONS
 INSTRUCTIONS DE MONTAGE - BAUANLEITUNG - INSTRUCCIONES DE MONTAJE

A

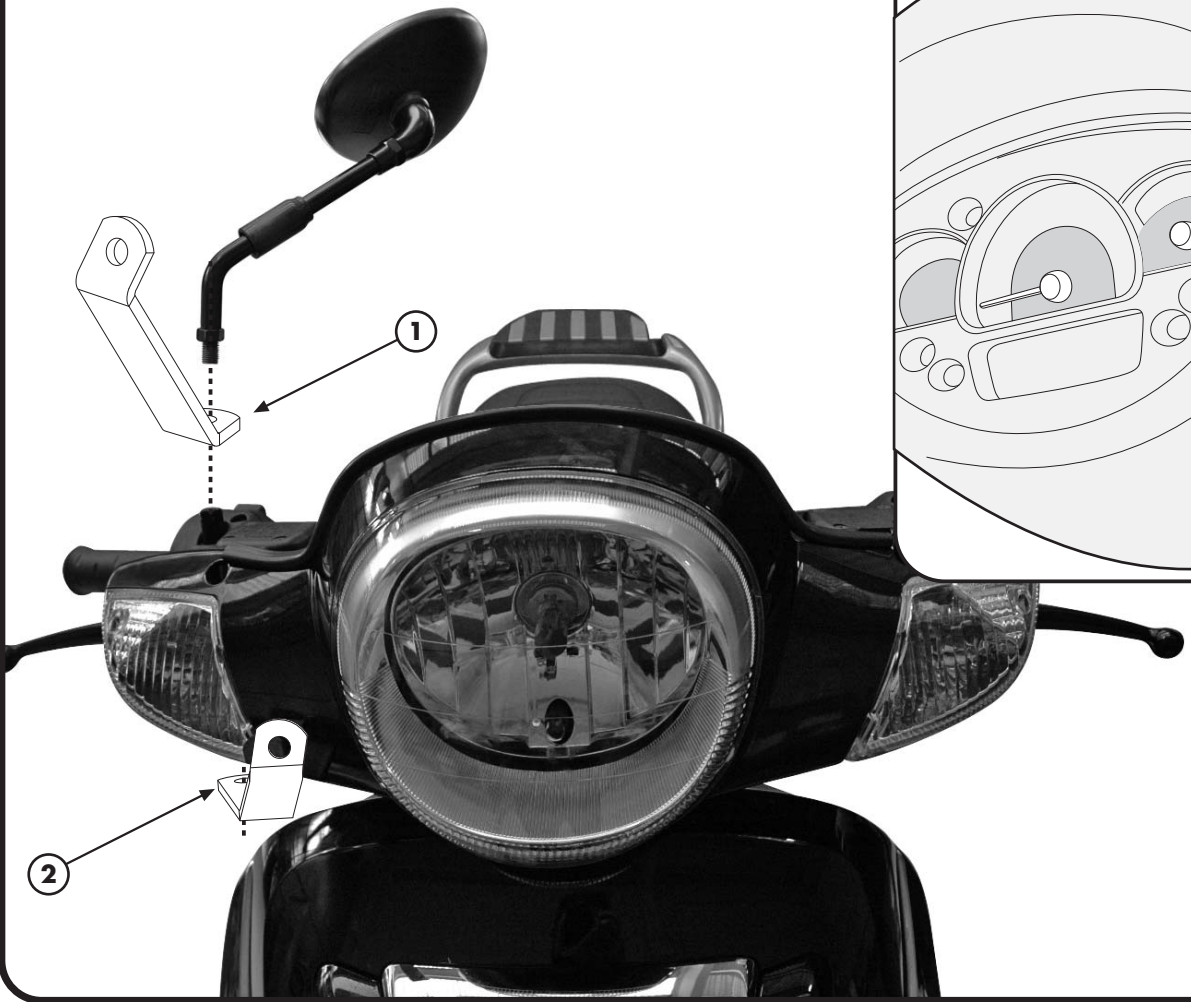

B

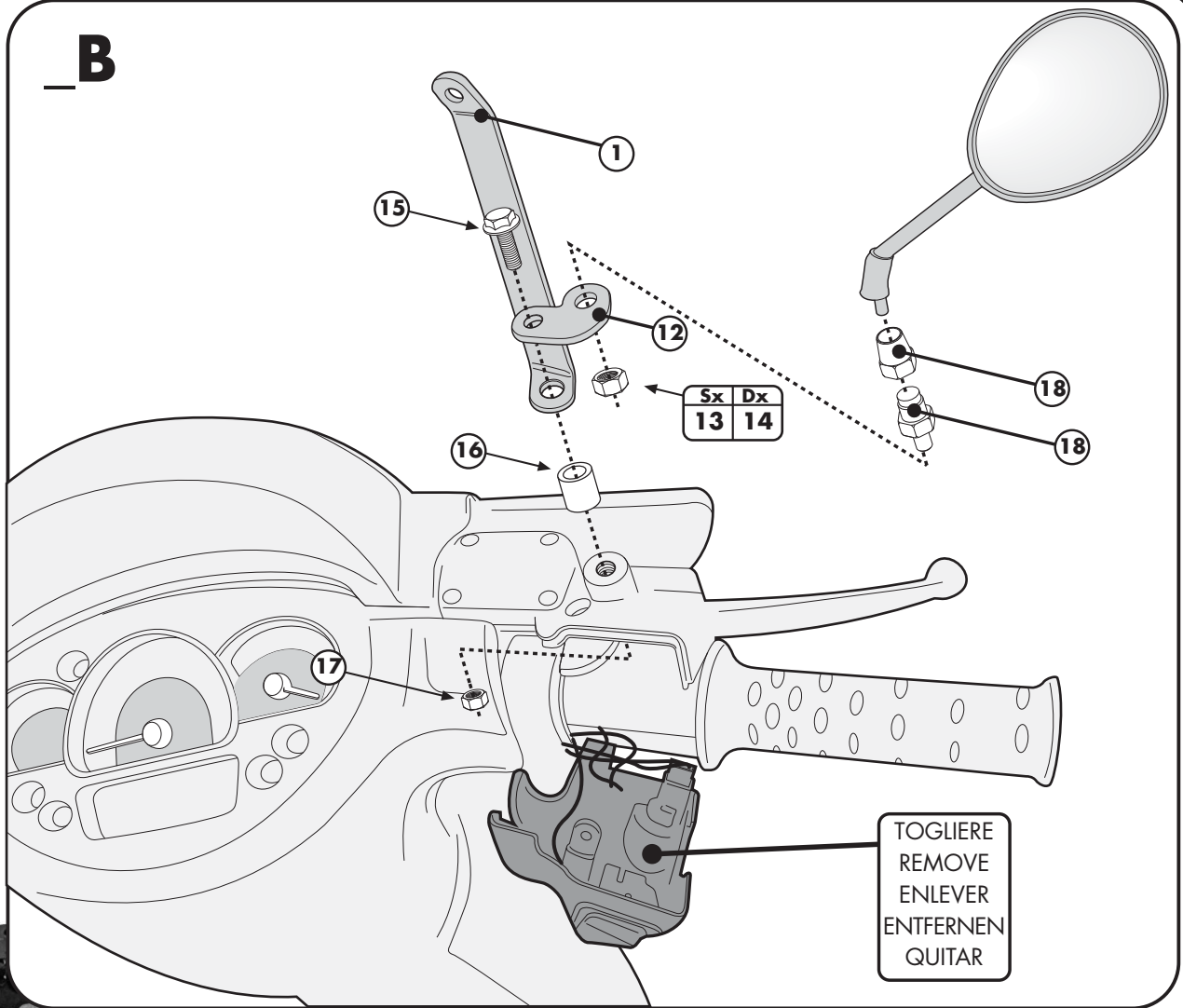

TOGLIERE
 REMOVE
 ENLEVER
 ENTFERNEN
 QUITAR