

ATTACCHI SPECIFICI PER - SPECIFIC FITTING KIT FOR
 KIT DE MONTAGE SPECIFIQUE POUR - SPEZIFISCHER MONTAGEKIT F R
 ANCLAJE ESPECCEFICO PARA

APRILIA SPORTCITY 2005

125/200cc

ISTRUZIONI DI MONTAGGIO - MOUNTING INSTRUCTIONS
 INSTRUCTIONS DE MONTAGE - BAUANLEITUNG - INSTRUCCIONES DE MONTAJE

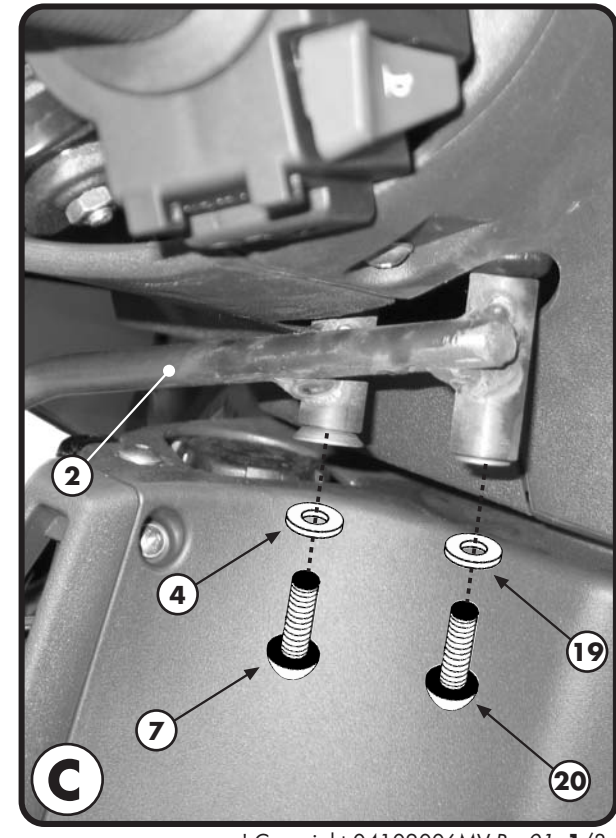
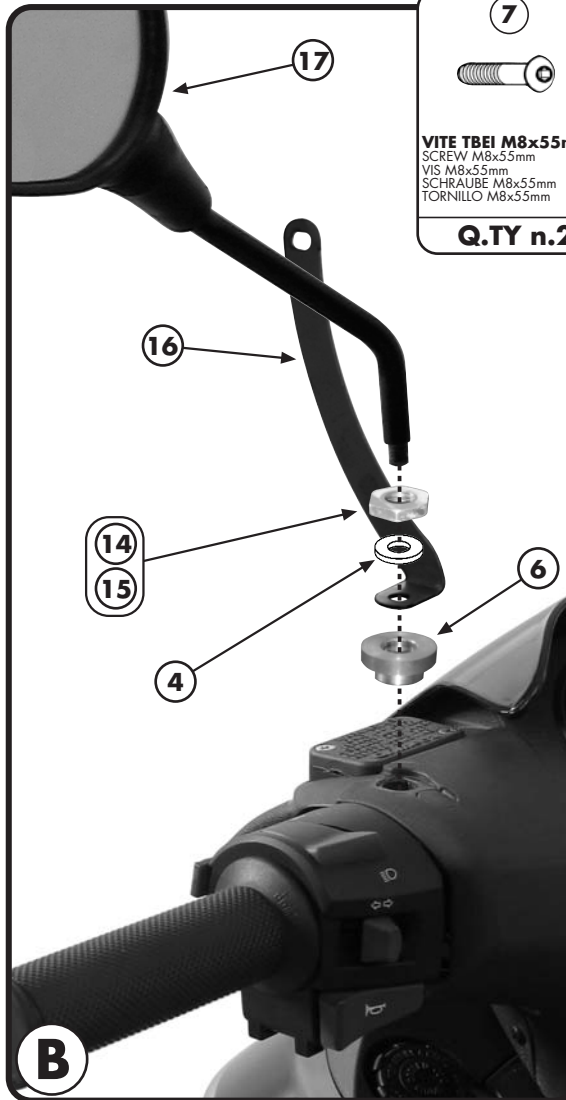
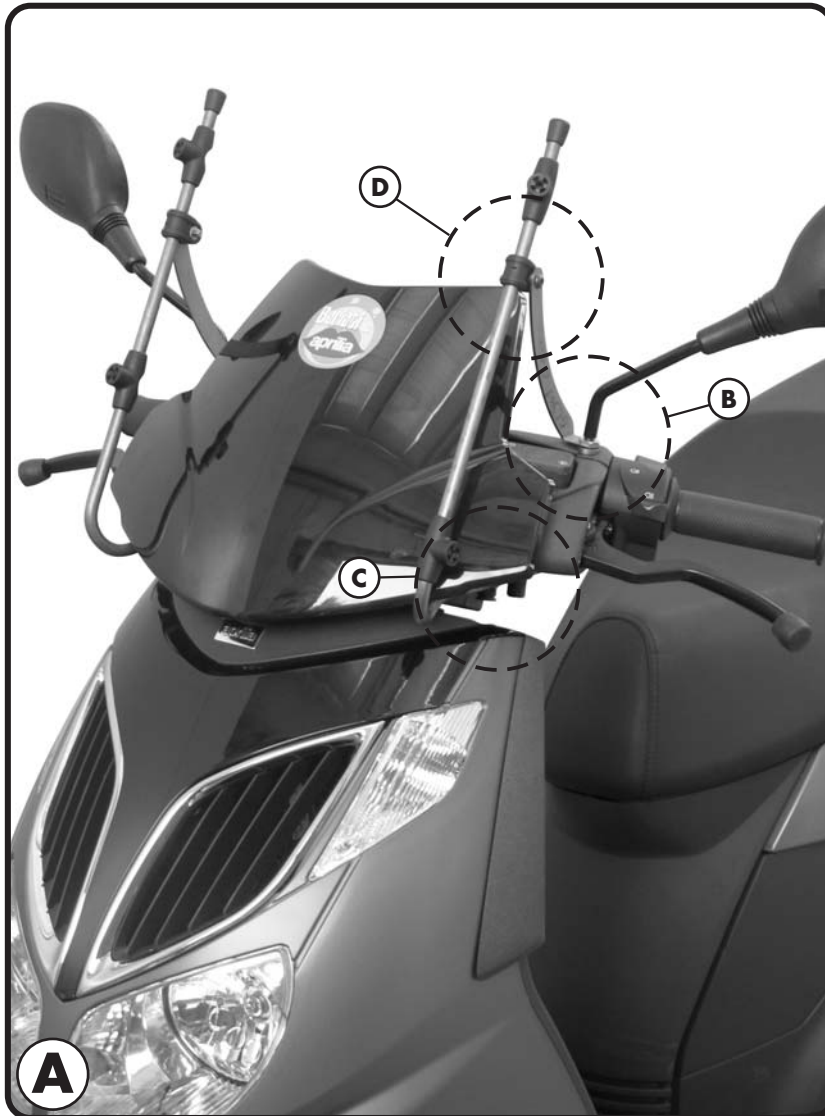
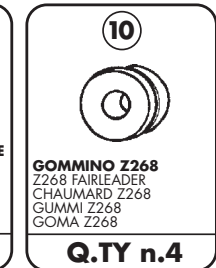
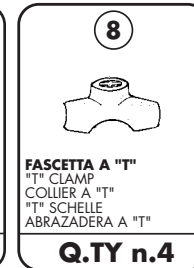
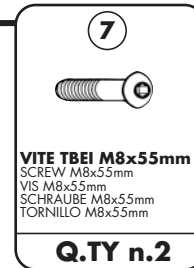
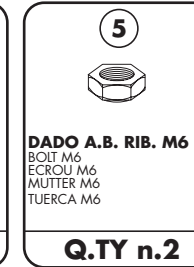
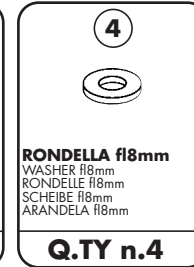
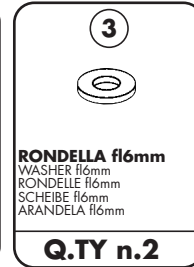
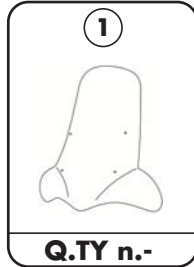

ATTACCHI SPECIFICI PER - SPECIFIC FITTING KIT FOR
 KIT DE MONTAGE SPECIFIQUE POUR - SPEZIFISCHER MONTAGEKIT F R
 ANCLAJE ESPECCEFICO PARA

APRILIA SPORTCITY 2005

125/200cc

ISTRUZIONI DI MONTAGGIO - MOUNTING INSTRUCTIONS
 INSTRUCTIONS DE MONTAGE - BAUANLEITUNG - INSTRUCCIONES DE MONTAJE

12



VITE TBEI M6x25 nera
 SCREW M6x25 black
 VIS M6x25 noire
 SCHRAUBE M6x25 schwarz
 TORNILLO M6x25 negra

Q.TY n.6

13



GOMMINO 8TAP
 RUBBER
 CAOUTCHOUC
 GUMMI
 GOMA

Q.TY n.2

14



DADO SPECIALE M8 FILETTO 5x V583
 BOLT M8
 ECROU M8
 MUTTER M8
 TUERCA M8

Q.TY n.1

15



DADO SPECIALE M8 FILETTO Dx V582
 BOLT M8
 ECROU M8
 MUTTER M8
 TUERCA M8

Q.TY n.1

16



SUPPORTO
 SUPPORT
 HALTERUNG
 SOPORTE

Q.TY n.2(Dx-5x)

17

COMPONENTI ORIGINALI
 ORIGINAL PARTS
 ORIGINAL BAUTEILE
 PARTIES ORIGINALES
 COMPONENTES ORIGINALES

Q.TY n.-

18



FASCETTA f110 nylon
 CLAMP f110
 COLLIER f110
 SCHELLE f110
 ABRAZADERA f110

Q.TY n.2

19



RONDELLA f16x16mm INOX
 WASHER f16mm
 RONDELLE f16mm
 SCHEIBE f16mm
 ARANDELA f16mm

Q.TY n.2

20

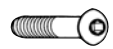

VITE TBEI M6x40mm
 SCREW M6x40mm
 VIS M6x40mm
 SCHRAUBE M6x40mm
 TORNILLO M6x40mm

Q.TY n.2

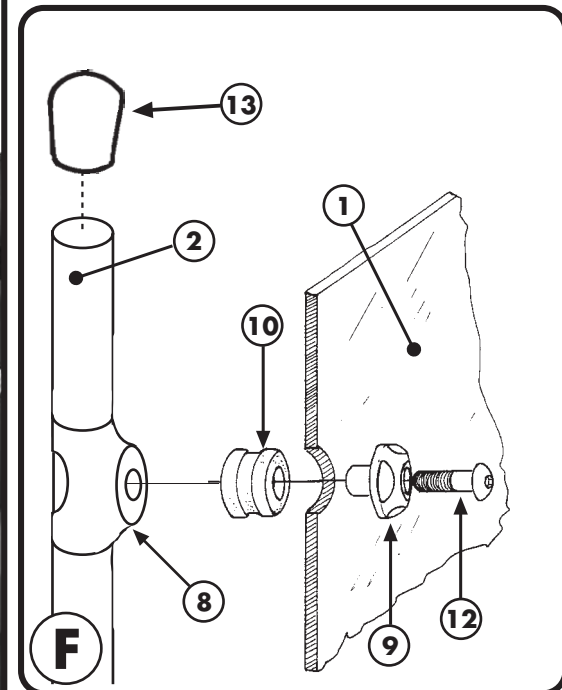
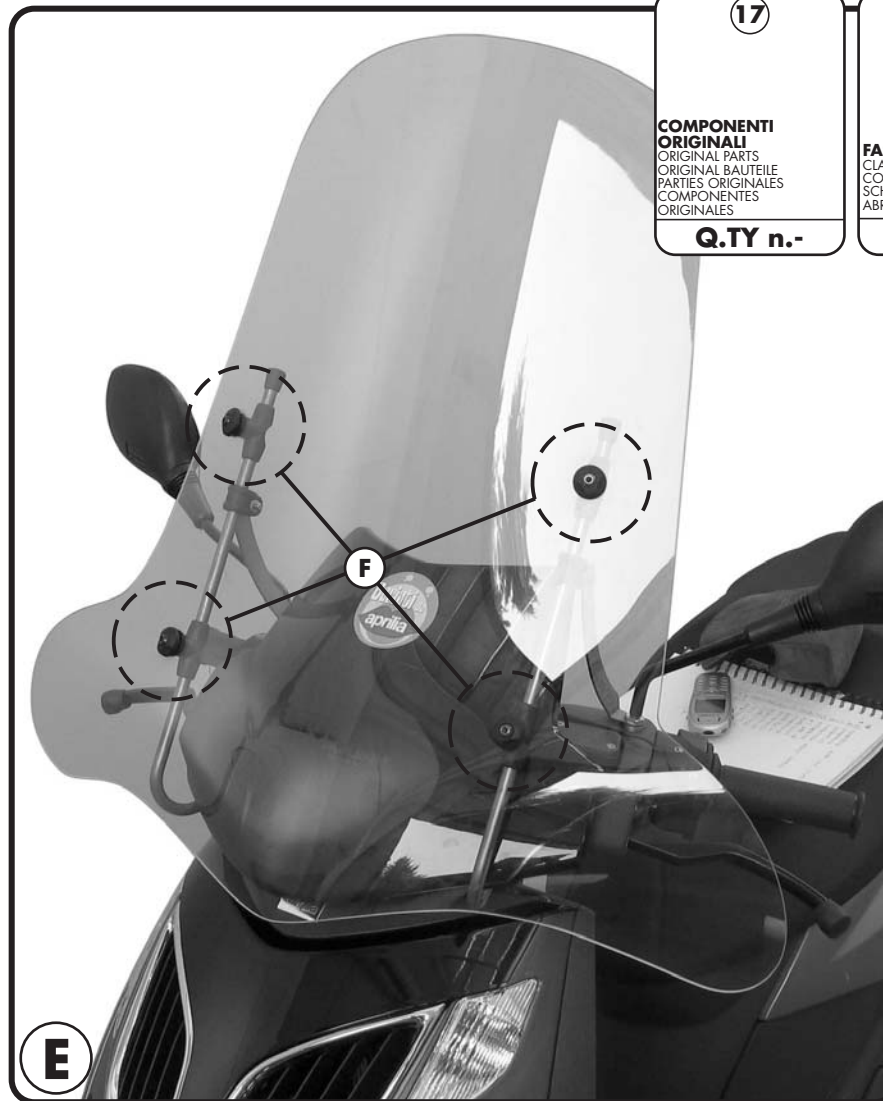
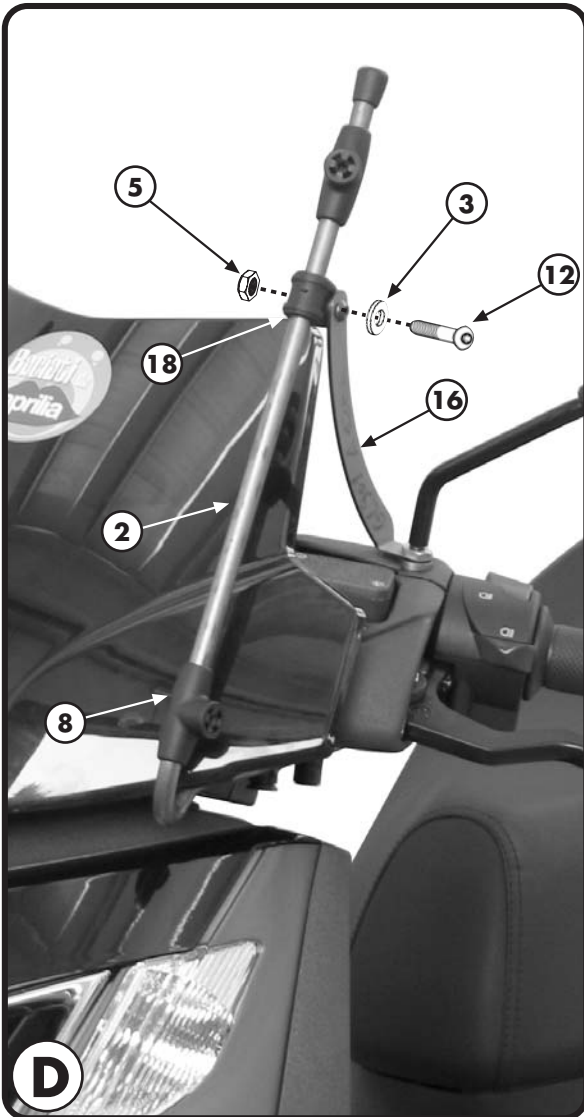

ATTACCHI SPECIFICI PER - SPECIFIC FITTING KIT FOR
KIT DE MONTAGE SPECIFIQUE POUR - SPEZIFISCHER MONTAGEKIT F R
ANCLAJE ESPECCEFICO PARA

APRILIA SPORTCITY 2005
125/200cc

ISTRUZIONI DI MONTAGGIO - MOUNTING INSTRUCTIONS
INSTRUCTIONS DE MONTAGE - BAUANLEITUNG - INSTRUCCIONES DE MONTAJE

I ISTRUZIONI DI MONTAGGIO

1. PRENDENDO COME RIFERIMENTO IL MONTAGGIO ILLUSTRATO IN FOTO A, SEGUIRE LE INDICAZIONI RIPORTATE IL FOTO B, FOTO C E FOTO D;
2. FAR ATTENZIONE AI PARTICOLARI N°14 E N°15, FOTO B; DEVE ESSERE UTILIZZATO IL PARTICOLARE ADATTO AL FILETTO DELLO SPECCHIETTO SU CUI VA MONTATO;
3. POSIZIONARE IL PARABREZZA (NON INCLUSO) COME INDICATO IN FOTO E, FACENDO RIFERIMENTO ALLO SCHEMA F PER IL FASSAGGIO;
4. ULTIMARE IL MONTAGGIO CONTROLLANDO CHE TUTTE LE VITI SIANO SERRATE BENE.

GB MOUNTING INSTRUCTIONS

1. MAKE REFERENCE TO THE MOUNTING SEQUENCE SHOWN IN PICTURE A AND FOLLOW THE DIRECTIONS SHOWN IN PICTURES B, C AND D;
2. PAY ATTENTION TO THE PARTS N° 14 AND 15, PICTURE B; YOU SHOULD CHOOSE THE CORRECT PART SUITABLE FOR THE THREAD OF THE MIRROR ON WHICH THIS IS TO BE MOUNTED;
3. PLACE THE WINDSCREEN (SOLD SEPARATELY) AS SHOWN IN PICTURE E AND REFER TO THE DRAWING F FOR MOUNTING;
4. LASTLY CHECK THAT ALL SCREWS HAVE BEEN TIGHTENED.

F INSTRUCTIONS DE MONTAGE

1. EN PRENANT COMME REFERENCE LE MONTAGE ILLUSTRE SUR LA PHOTO A, SUIVRE LES INDICATIONS DES PHOTOS B, C ET D;
2. FAIRE ATTENTION AUX PIECES N°14 ET N°15, PHOTO B; DOIT ETRE UTILISEE LA PIECE ADAPTEE AU FILETAGE (voir photo) DU RETROVISEUR SUR LEQUEL ELLE VA ETRE MONTE;
3. FIXER LE PARE-BRISE (NON INCLUS) COMME INDIQUE SUR MA PHOTO E, EN SE REFERANT AU DESSIN F POUR LE MONTAGE;
4. FINIR LE MONTAGE EN CONTROLANT LE BON SERRAGE DE TOUTES LES VIS.

D BAUANLEITUNG

1. NEHMEN SIE BEZUG AUF DIE ABGEBILDETE MONTAGE VOM BILD A UND FOLGEN SIE DEN HINWEISEN DER BILDER B, C UND D;
2. ACHTEN SIE AUF DIE TEILE NR. 14 UND 15, BILD B; ES SOLL DAS RICHTIGE TEIL PASSEND FÜR DIE GEWINDE DER SPIEGEL VERWENDET WERDEN;
3. POSITIONIEREN SIE DAS WINDSCHILD (NICHT VORHANDEN) WIE IM BILD E GEZEIGT, DABEI NEHMEN SIE AUF DAS SCHEMA F FÜR DIE MONTAGE BEZUG;
4. ZULETZT BERÜCKSICHTIGEN SIE, DASS ALLE SCHRAUBEN FESTGEZOGEN WURDEN.

ES

INSTRUCCIONES DE MONTAJE

1. USANDO COMO REFERENCIA EL MONTAJE INDICADO EN LA FOTO A; SEGUIR LAS INSTRUCCIONES INDICADAS POR LAS FOTOS B, C Y D;
2. TENER CUIDADO CON LAS PIEZAS NR 14 Y NR 15 (VER FOTO B); UTILIZAR LA PIEZA APTA A LA ROSCA DEL ESPEJO QUE SUJETA EL MONTAJE;
3. MONTAR LA PANTALLA (NO INCLUIDA — SE VENDE POR SEPARADO) COMO INDICA LA FOTO E; TENIENDO EN CUENTA LAS INDICACIONES DEL DIBUJO F PARA ANCLARLA;
4. TERMINAR EL MONTAJE APRETANDO LOS TORNILLOS.