

MONORACK SPECIFICO - SPECIFIC MONORACK
MONORACK SPECIFIQUE - SPEZIFISCHES MONORACK - MONORACK ESPECÍFICO

KAWASAKI Z750S 2005

ISTRUZIONI DI MONTAGGIO - MOUNTING INSTRUCTIONS
INSTRUCTIONS DE MONTAGE - BAUANLEITUNG - INSTRUCCIONES DE MONTAJE

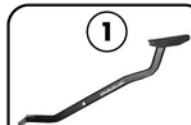

SUPPORTO
SUPPORT
SUPPORT
HALTER
SOPORTES

Q.TY n.2(Dx-Sx)



SUPPORTO
SUPPORT
SUPPORT
HALTER
SOPORTES

Q.TY n.2(Dx-Sx)



SUPPORTO
SUPPORT
SUPPORT
HALTER
SOPORTES

Q.TY n.2(Dx-Sx)



SUPPORTO
SUPPORT
SUPPORT
HALTER
SOPORTES

Q.TY n.1

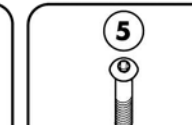

VITE TBEI M10x35mm
Passo 1,25
SCREW M8x35mm
VIS M8x35mm
SCHRAUBE M8x35mm
TORNILLO M8x35mm

Q.TY n.4

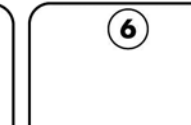

COMPONENTI ORIGINALI
ORIGINAL PARTS
ORIGINAL BAUTEILE
PARTIES ORIGINALES
COMPONENTES ORIGINALES

Q.TY n.-

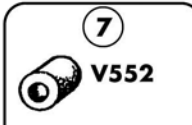

V552
DISTANZIALE Ø20x8
foro 10,5mm
SPACER
ENTRETOISE
DISTANZSTUECK
DISTANCIADOR

Q.TY n.2

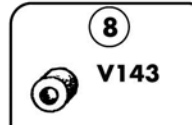

V143
DISTANZIALE Ø20x4
foro 10,5mm
SPACER
ENTRETOISE
DISTANZSTUECK
DISTANCIADOR

Q.TY n.2



DADO A.B. M8
BOLT M8
ECROU M8
MUTTER M8
TUERCA M8

Q.TY n.2



RONDELLA Ø8
WASHER Ø8
RONDELLE Ø8
SCHEIBE Ø8
ARANDELA Ø8

Q.TY n.4

ALLARGARE I FORI SULLE PLASTICHE ORIGINALI FINO AD UN DIAMETRO DI Ø8,5mm

ENLARGE THE HOLES OF THE ORIGINAL PLASTIC TRAY TO A DIAMETER OF Ø8,5mm

AGRANDIR LES TROUS DU PLASTIQUE D'ORIGINE A UN DIAMETRE DE 8.5mm

BOHREN SIE DIE ORIGINAL PLASTIK ABDECKUNG AUF EINEM DURCHMESSER VON Ø8,5mm AUF

ESANCHAR LOS AGUJEROS DEL CARENADO HASTA CONSEGUIR UN DIÁMETRO DE Ø8,5mms

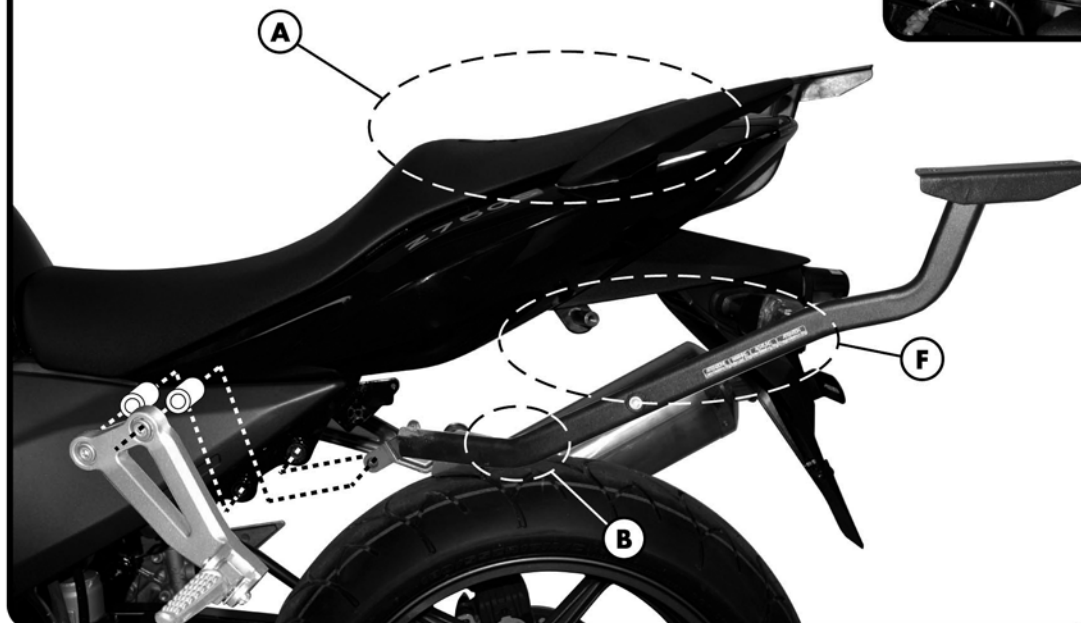
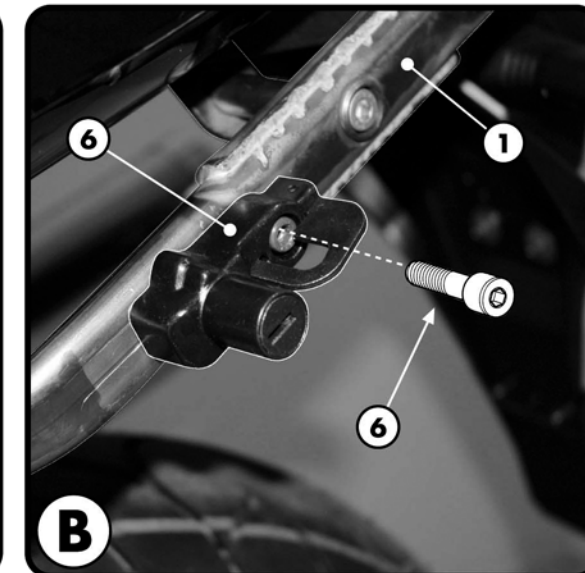
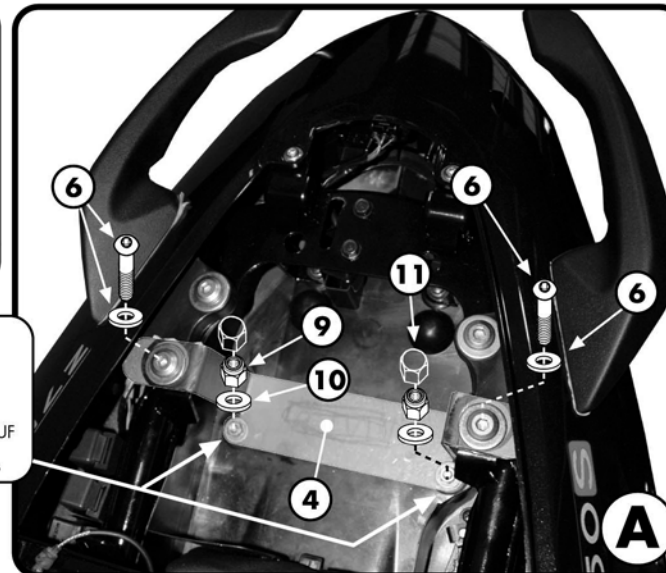

ATTENZIONE: PESO MASSIMO SOPPORTABILE DAL PORTAPACCO 6Kg.

WARNING: MAX. LOADING OF THE CARRIER 6Kg. (13lbs)

ATTENTION: CHARGE MAXIMALE 6Kg.

ACHTUNG: MAXIMALE BELASTUNG DES TRAGERS 6Kg.

ATENCION: CARGA MÁXIMA AUTORIZADA DEL PORTAEQUIPAJE 6Kg.

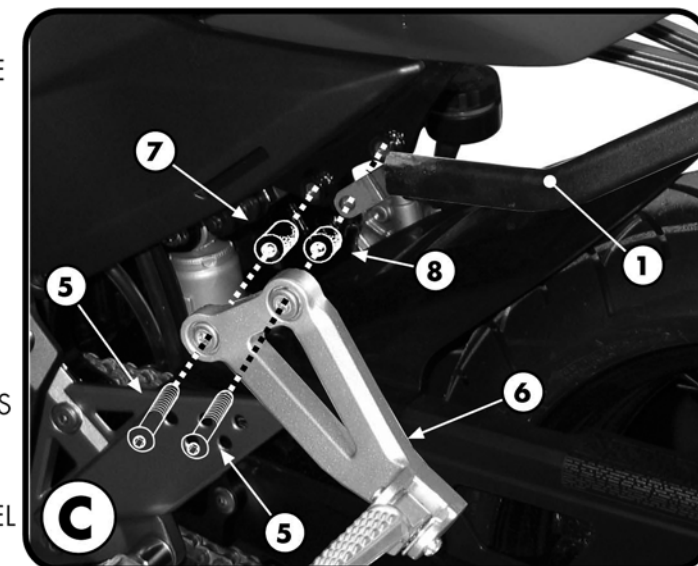

MONORACK SPECIFICO - SPECIFIC MONORACK
MONORACK SPECIFIQUE - SPEZIFISCHES MONORACK - MONORACK ESPECÍFICO

KAWASAKI Z750S 2005

ISTRUZIONI DI MONTAGGIO - MOUNTING INSTRUCTIONS
INSTRUCTIONS DE MONTAGE - BAUANLEITUNG - INSTRUCCIONES DE MONTAJE

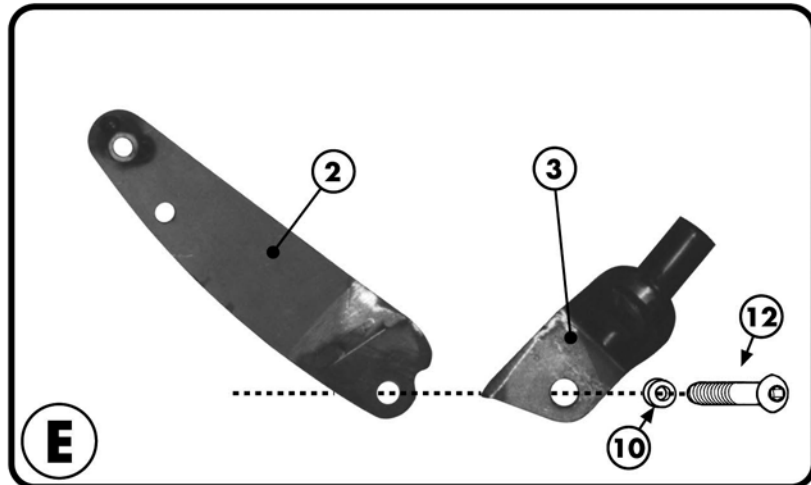
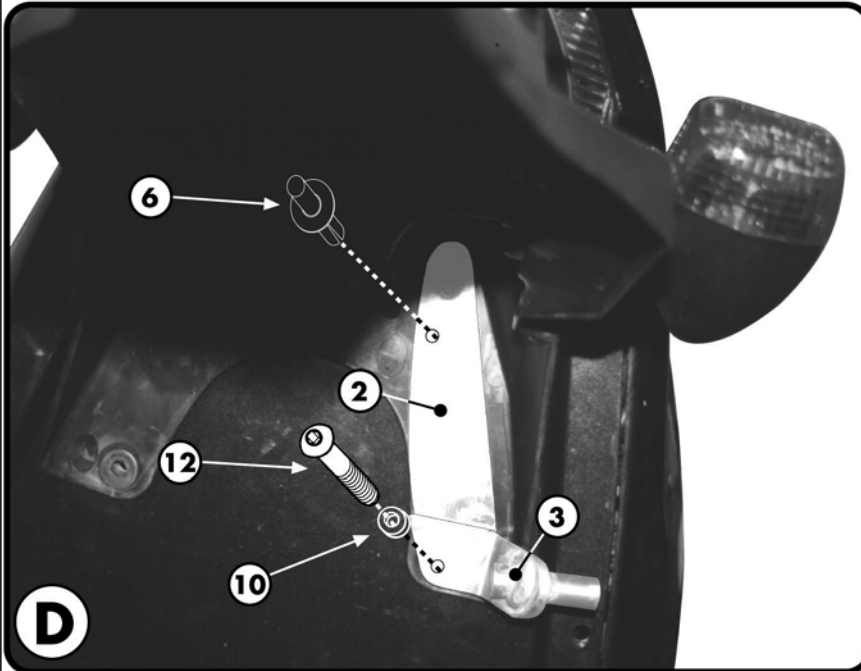

11



COPRIDADO M8
BOIT CAP
CACHE ECROU
STOPSMUTTER
TAPA TUERCA

Q.TY n.2

12



VITE TBEI M8x35mm
SCREW M8x35mm
VIS M8x35mm
SCHRAUBE M8x35mm
TORNILLO M8x35mm

Q.TY n.2

13



COPRIVITE Ø8mm
BOIT
SCREW CAP
CACHE VIS
STOPSSCHRAUBE
TAPA TORNILLO

Q.TY n.2

14



VITE TCEI M8x25mm
SCREW M8x25mm
VIS M8x25mm
SCHRAUBE M8x25mm
TORNILLO M8x25mm

Q.TY n.2

15

**PARTICOLARI INCLUSI NEL
KIT VITERIA DELLA PIASTRA**
COMPONENTS INCLUDED IN
THE FITTING KIT OF THE PLATE
PIÈCES INCLUES DANS LE KIT
DE VIS DE LA PLATINE
DIE EINZELNEN TEILE SIND BEI
MONTAGEKIT DER PLATTE
ENTHALTEN
DESPIECES INCLUIDOS EN EL
KIT DE ANCLAJES DE LA
PARRILLA

Q.TY n.-

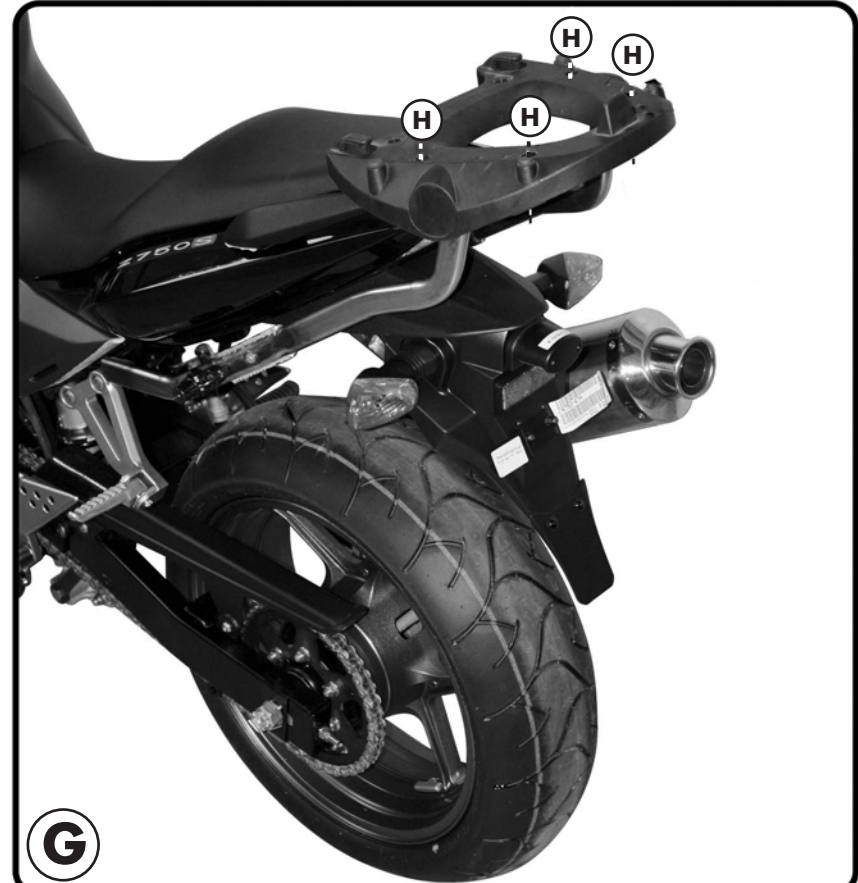
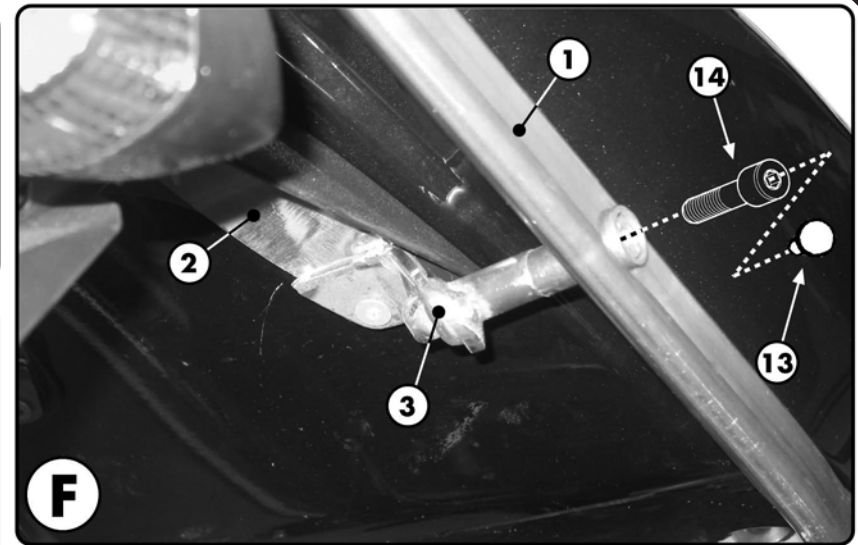

MONORACK SPECIFICO - SPECIFIC MONORACK
 MONORACK SPECIFIQUE - SPEZIFISCHES MONORACK - MONORACK ESPECÍFICO

KAWASAKI Z750S 2005

ISTRUZIONI DI MONTAGGIO - MOUNTING INSTRUCTIONS
 INSTRUCTIONS DE MONTAGE - BAUANLEITUNG - INSTRUCCIONES DE MONTAJE

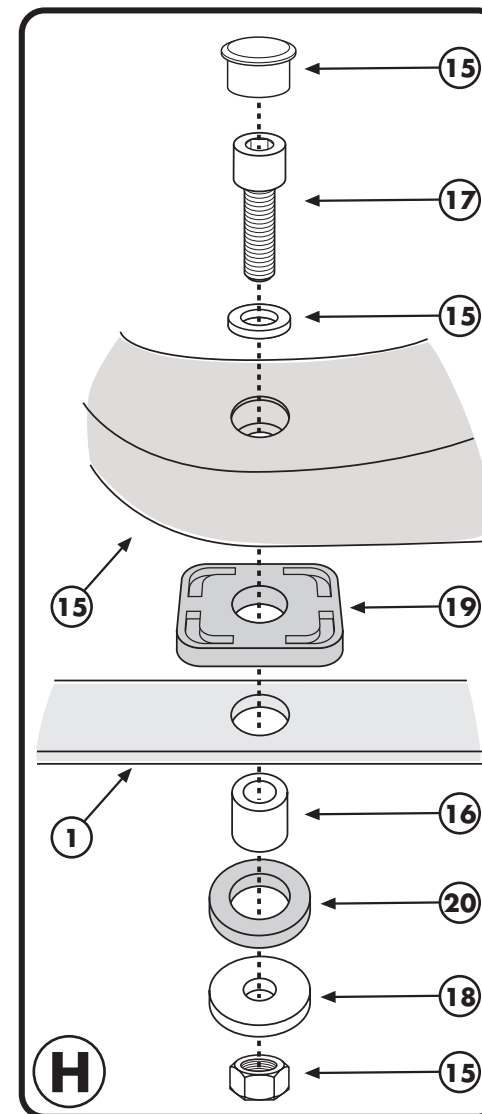
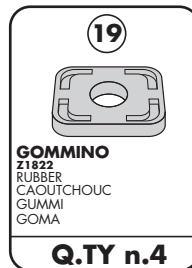
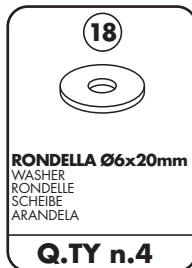
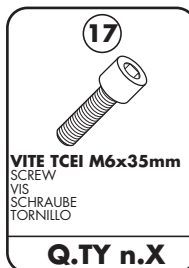

MONORACK SPECIFICO - SPECIFIC MONORACK
MONORACK SPECIFIQUE - SPEZIFISCHES MONORACK - MONORACK ESPECÍFICO

KAWASAKI Z750S 2005

ISTRUZIONI DI MONTAGGIO - MOUNTING INSTRUCTIONS
INSTRUCTIONS DE MONTAGE - BAUANLEITUNG - INSTRUCCIONES DE MONTAJE

I ISTRUZIONI DI MONTAGGIO

1. POSIZIONARE LA PIASTRA SAGOMATA N°4 (FOTO A), ALLARGARE I FORI INDICATI IN FOTO A FINO AD UN DIAMETRO DI Ø8,5mm;
2. POSIZIONARE LA PIASTRA N°2 (FOTO D) SOSTITUENDOLA A QUELLA ORIGINALE OCCUPANTE LA STESSA POSIZIONE; SOVRAPPORRE ALLA PIASTRA N°2 IL SUPPORTO N°3 (FOTO E); NOTARE CHE IL BULLONE N°12 SI FISSA STRINGENDO IL DADO N°9 IN FOTO A; RIPOSIZIONARE IL PARTICOLARE N°6 DI FOTO D;
3. ESEGUIRE IL MONTAGGIO INDICATO IN FOTO C;
4. FISSARE LA STAFFA N°1 AL SUPPORTO N°3 COME INDICATO IN FOTO F; FISSARE IL LUCCHETTO PORTACASCO ORIGINALE COME INDICATO IN FOTO B;
5. MONTARE LA PIASTRA (VENDUTA SEPARATAMENTE) SEGUENDO LE INDICAZIONI DI FOTO G E COMPLETANDO CON LE ISTRUZIONI CONTENUTE NELLA SUA CONFEZIONE;
6. ULTIMARE IL MONTAGGIO SERRANDO BENE TUTTE LE VITI.

E MOUNTING INSTRUCTIONS

1. PLACE THE SUPPORT N°4 (PICTURE A) AND ENLARGE THE HOLES SHOWN IN THE PICTURE TO A DIAMETER OF Ø 8,5 MM;
2. PLACE THE PLATE N°2 (PICTURE D) REPLACING THE ORIGINAL PLATE; THEN PLACE THE SUPPORT N° 3 (PICTURE E) ON THE PLATE N° 2; PLEASE NOTE THAT THE SCREW N°12 IS FIXED BY TIGHTENING THE BOLT N° 9 IN PICTURE A; LASTLY RE-POSITION THE PART N° 6 OF PICTURE D.
3. PROCEED WITH THE MOUNTING AS SHOWN IN PICTURE C;
4. FIX THE SIDE SUPPORT N°1 TO THE SUPPORT N°3 AS SHOWN IN PICTURE F; THEN FIX THE ORIGINAL HELMET LOCK AS SHOWN IN PICTURE B;
5. NOW MOUNT THE PLATE (SOLD SEPARATELY) AS SHOWN IN PICTURE G AND FOLLOWING THE MOUNTING INSTRUCTION INCLUDED IN ITS BOX.
6. LASTLY TIGHTEN ALL THE SCREWS.

F INSTRUCTIONS DE MONTAGE

1. POSITIONNER LE SUPPORT PROFILE N°4 (PHOTO A), AGRANDIR LES TROUS INDIGUES SUR LA PHOTO A UN DIAMETRE DE 8.5MM;
2. POSITIONNER LA PIECE N°2 (PHOTO D) A LA PLACE DE LA PIECE ORIGINALE SITUEE A CET ENDROIT; SUPERPOSER LE SUPPORT N°3 SUR LA PIECE N°2 (PHOTO E); NOTER QUE LA VIS N°12 EST FIXEE PAR L'ECROU N°9 DE LA PHOTO A; REPOSITIONNER LA PIECE N° 6 DE LA PHOTO D;
3. PROCEDER AU MONTAGE INDIQUE SUR LA PHOTO C;
4. FIXER LES BRAS N°1 AUX SUPPORTS N°3 COMME INDIQUE SUR LA PHOTO F; FIXER L'ANTIVOL DE CASQUE D'ORIGINE COMME INDIQUE SUR LA PHOTO B;
5. MONTER LA PLATINE (VENDUE SEPARÉMENT) EN SUIVANT LES INDICATIONS DE LA PHOTO G COMPLÉTEES PAR LES INSTRUCTIONS LIVREES AVEC CELLE-CI;
6. FINIR LE MONTAGE EN SERRANT BIEN TOUTES LES VIS.

D BAUANLEITUNG

1. POSITIONIEREN SIE DEN HALTER NR. 4 (BILD A). BOHREN SIE DURCH DEN HALTER NR. 4 DIE LÖCHER (BILD A) MIT EINEM DURCHMESSER VON Ø 8,5 MM.
2. ERSETZEN SIE DEN ORIGINAL HALTER DURCH DEN HALTER NR. 2 (BILD D). VERSCHRAUBEN SIE DAS TEIL NR. 3 (BILD E) MIT DEM HALTER NR. 2. VERWENDEN SIE DAZU DIE SCHRAUBE NR. 12 UND DIE MUTTER NR. 9 (BILD A). POSITIONIEREN SIE DAS TEIL NR. 6 (BILD D) WIEDER AM URSPRÜNGLICHEN PLATZ.
3. GEHEN SIE MIT DER MONTAGE WEITER IM BILD C BESCHRIEBEN.
4. MONTIEREN SIE DEN HALTER NR. 1 AN DIE HALTERUNG NR. 3 WIE IM BILD F BESCHRIEBEN. BEFESTIGEN SIE DAS ORIGINAL HELMHALTESCHLOSS WIE IM BILD B BESCHRIEBEN;
5. BEFESTIGEN SIE JETZT DEN HALTER NR. 1 AN DEN HALTER NR. 3 WIE IM BILD F BESCHRIEBEN.
6. MONTIEREN SIE DIE PLATTE (IST SEPARAT ZU BESTELLEN) WIE IM BILD G. BEACHTEN SIE DIE BAUANLEITUNG, DIE MIT DER PLATTE MITGELIEFERT WIRD.
7. ZULETZT ZIEHEN SIE ALLE SCHRAUBEN FEST.

ES

INSTRUCCIONES DE MONTAJE

1. POSICIONAR EL SOPORTE N° 4 COMO INDICA LA FOTO A, ESANCHAR LOS AGUJEROS DEL CARENADO HASTA CONSEGUIR UN DIÁMETRO DE 8,5 MMS.;
2. POSICIONAR EL SOPORTE N° 2 COMO INDICA LA FOTO D SUBSTITUYÉNDO EL ORIGINAL, SOBREPONER EL SOPORTE N° 3 AL SOPORTE N° 2 COMO INDICA A FOTO E; TENIENDO EN CUENTA QUE EL TORNILLO N°12 SE COMBINA CON LA TUERCA N° 9 (VER FOTO A), VOLVER A POSICIONAR EL DESPIEZE N° 6 COMO INDICA LA FOTO D;
3. EJECUTAR EL MONTAJE INDICADO EN LA FOTO C;
4. ANCLAR EL BRAZO MONORACK N° 1 AL SOPORTE N°3 COMO INDICA LA FOTO F; ANCLAR EL CANDADO PORTA CASCO ORIGINAL COMO INDICA LA FOTO B;
5. MONTAR LA PARRILLA (NO INCLUIDA - SE VENDE POR SEPARADO) SEGUN LAS INSTRUCCIONES INDICADAS POR LA FOTO G Y TENIENDO EN CUENTA LAS INSTRUCCIONES INCLUIDAS EN LA CONFECCION DE LA PARRILLA MISMA;
6. TERMINAR APRETANDO BIEN TODOS LOS TORNILLOS