

MONORACK SPECIFICO - SPECIFIC MONORACK
MONORACK SPECIFIQUE - SPEZIFISCHES MONORACK - MONORACK ESPECÍFICO

YAMAHA FZ1 FAZER 2006

ISTRUZIONI DI MONTAGGIO - MOUNTING INSTRUCTIONS
INSTRUCTIONS DE MONTAGE - BAUANLEITUNG - INSTRUCCIONES DE MONTAJE

SI RACCOMANDA DI FARE ESEGUIRE IL MONTAGGIO AD UN MECCANICO QUALIFICATO

WE RECOMMEND THAT THE MOUNTING IS CARRIED OUT BY A QUALIFIED MOTORCYCLE MECHANIC

IL EST RECOMMANDE DE FAIRE EXECUTER LE MONTAGE PAR UN MECANICIEN QUALIFIE

WIR EMPFEHLEN, DAß DIE MONTAGE VON EINEM FACHMECHANIKER DURCHFÜHRT WIRD

LES RECOMENDAMOS QUE EL MONTAJE DE LA DEFENSA SE REALICE POR UN MECANICO CALIFICADO

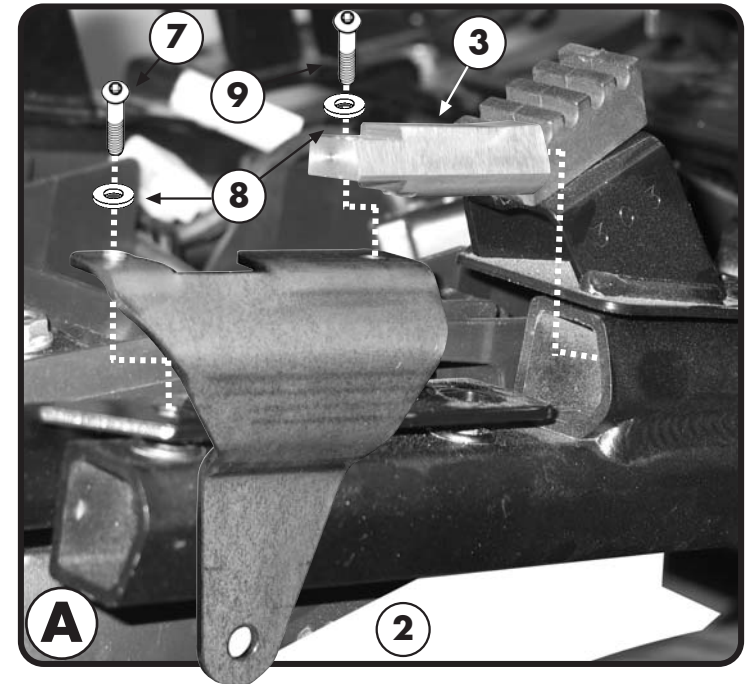
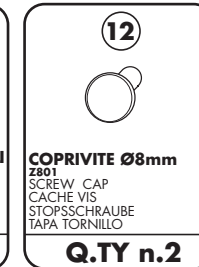
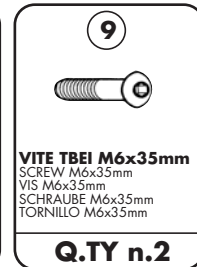
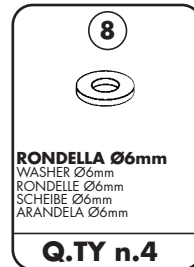
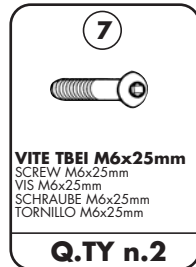
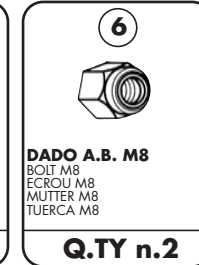
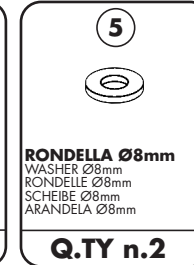
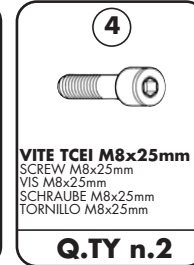
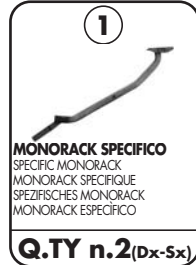
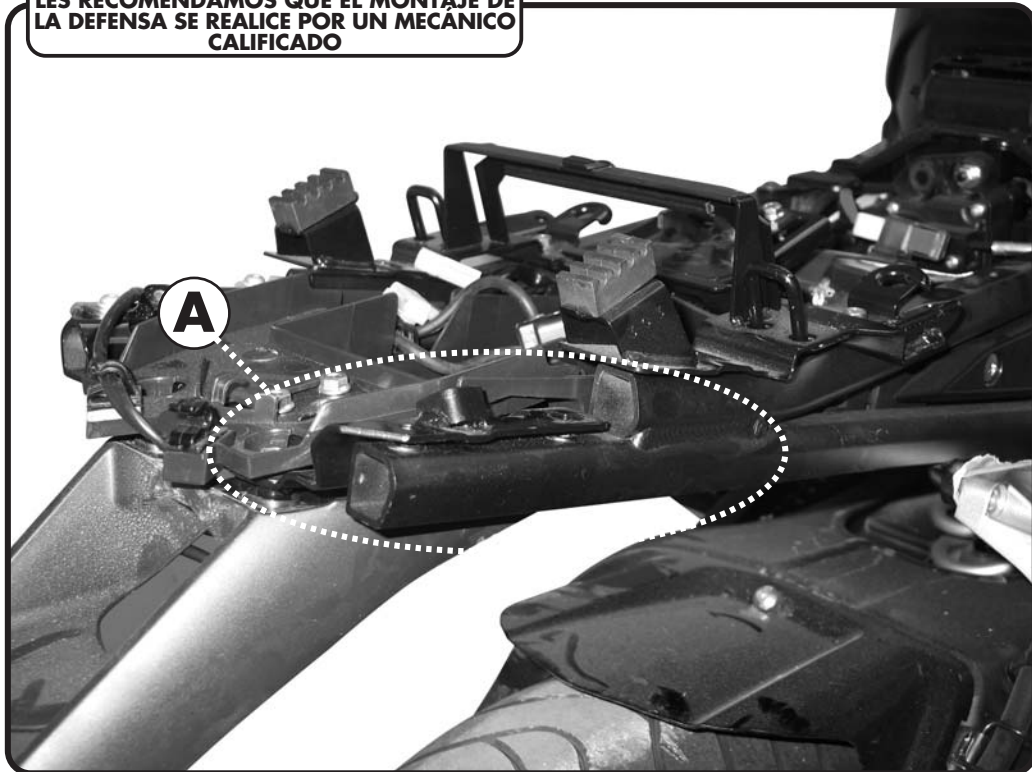

MONORACK SPECIFICO - SPECIFIC MONORACK
MONORACK SPECIFIQUE - SPEZIFISCHES MONORACK - MONORACK ESPECÍFICO

YAMAHA FZ1 FAZER 2006

ISTRUZIONI DI MONTAGGIO - MOUNTING INSTRUCTIONS
INSTRUCTIONS DE MONTAGE - BAUANLEITUNG - INSTRUCCIONES DE MONTAJE

PRIMA DI RIMONTARE LA CODA DELLA MOTOCICLETTA BISOGNA TAGLIARE LA PARTE TRATTEGGIATA DELLA PLASTICA SOTTOCODA INDICATA NELL'IMMAGINE AL FINE DI OTTENERE IL RISULTATO EVIDENZIATO NEL CERCHIO

BEFORE REMOUNTING THE TAIL FAIRING, CUT OUT THE PLASTIC UNDER THE TAIL AS INDICATED WITH THE DASHED LINE IN ORDER TO OBTAIN THE CUT OUT AS SHOWN IN THE CIRCLE

AVANT DE REMONTER LA COQUE DE LA MOTO, IL EST NECESSAIRE DE DECOUPER LA PARTIE EN POINTILLE DE L'AILERON EN PLASTIQUE AFIN D'OBTENIR LE RESULTAT MIS EN EVIDENCE DANS LE CERCLE

BEVOR SIE DAS HECK DES FAHRZEUGES WIEDER MONTIEREN, IST ES NOTWENDIG, DAS KUNSTSTOFFTEIL UNTER DEM HECK WIE IN DEM BILD (GESTRICHELTE LINIE) ZU SCHNEIDEN, UM DAS ERGEBNIS GEZEIGT IN DEM KREIS ZU ERHALTEN.

ANTES DE DESMONTAR EL COLÍN DE LA MOTOCICLETA CORTAR EL PLÁSTICO PO LA LINEA DE PUNTOS, UTILIZANDO LA PLANTILLA, TAL Y COMO SE INDICA EN LA IMAGEN, CON EL FIN DE OBTENER EL RESULTADO EVIDENCIADO EN EL CÍRCULO

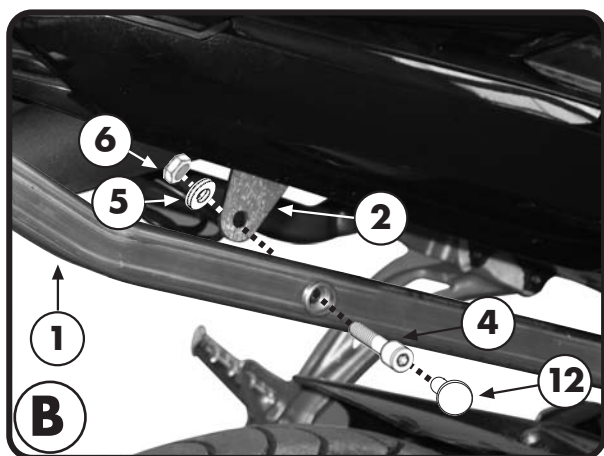

ATTENZIONE
BAULETTO CON LITRAGGIO MASSIMO
CONSENTITO 37LT.

ATTENTION
ONLY TO BE MOUNTED WITH TOP-
CASES WITH A MAXIMUM CAPACITY
OF 37 LITRES.

ATTENTION
LITRAGE/VOLUME ADMIS 37 LITRES

ACHTUNG
NUR ZUR MONTAGE MIT EINEM KOFFER
EINER MAXIMALEN LITERANGABE VON
37 LITER.

¡ATENCIÓN!
BAÚL CON CARGA MÁXIMA DE 37 LTS.

ATTENZIONE: CARICO MASSIMO 6Kg
WARNING: MAX LOAD, 6Kg.
ATTENTION: CHARGE MAXIMUM, 6Kg.
ACHTUNG: MAX, 6Kg.
¡ATENCIÓN!: CARGA MÁXIMA, 6Kg.

GIVI DECLINA OGNI RESPONSABILITÀ PER I
DANNI CAUSATI DAL
MONTAGGIO DI BAULETTI PIÙ GRANDI.
VA PERTANTO ABBINATA ESCLUSIVAMENTE
LA PIASTRA M5M

GIVI DECLINES ANY RESPONSIBILITY FOR
DAMAGES CAUSED BY FITTING OF BIGGER
CASES. THEREFORE WE STRONGLY SUGGEST
TO MOUNT ONLY THE PLATE M5M

GIVI DECLINE TOUTE RESPONSABILITE POUR
LES DOMMAGES CAUSES SUITE AU
MONTAGE D'UN TOP CASE PLUS GRAND.
C'EST POURQUOI ON NE PEUT MONTER
EXCLUSIVEMENT QUE LA PLATINE M5M

GIVI LEHNT JEGLICHE VERANTWORTUNG AB
FÜR EVENTUELLE SCHADEN VERURSACHT
DURCH DIE MONTAGE VON GRÖßEREN
KOFFER. DAHER SOLL AUSSCHLIEßLICH DIE
PLATTE M5M VERWENDET WERDEN

GIVI NO SE HACE RESPONSABLE DE LOS
DANOS CAUSADOS EN EL MONTAJE DE LOS
BAULES DEMASIADOS GRANDES.
VA POR LO TANTO ACOPLADA
EXCLUSIVAMENTE A LA PARRILLA M5M
(SISTEMA DE ANCLAJE MONOLOCK)

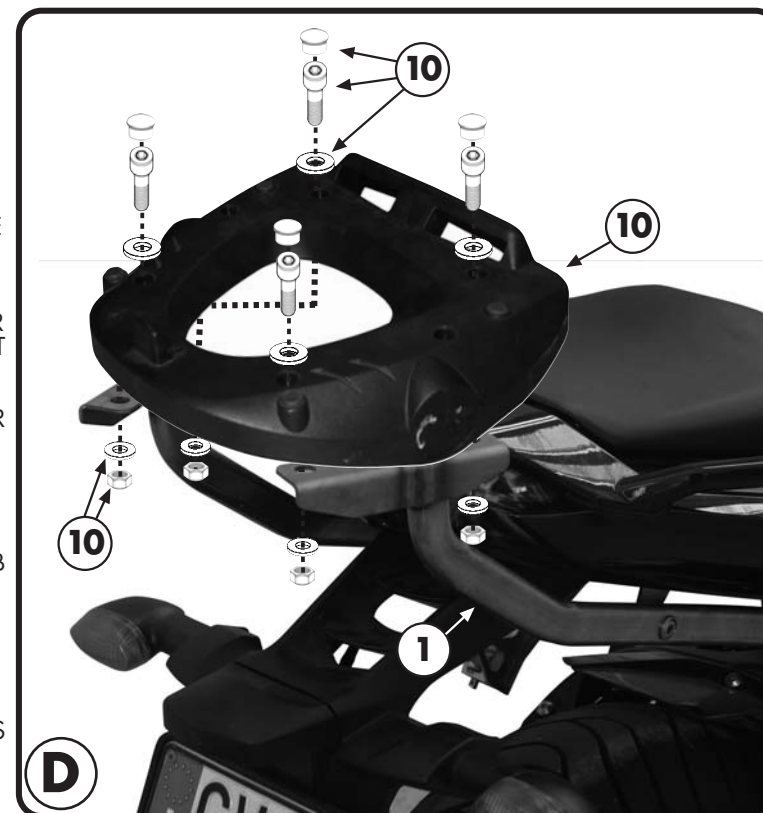
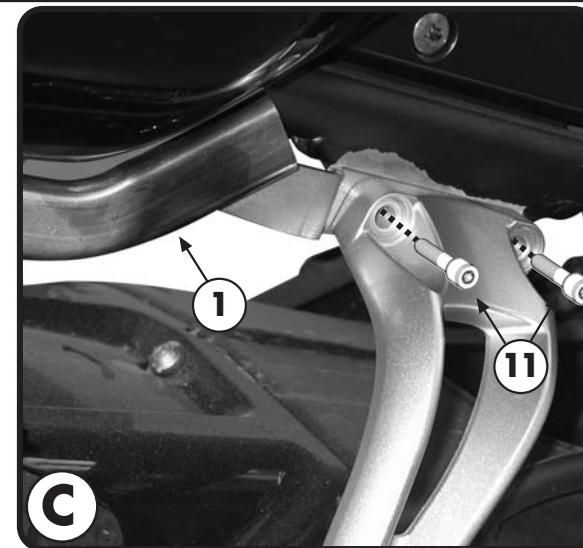

MONORACK SPECIFICO - SPECIFIC MONORACK
MONORACK SPECIFIQUE - SPEZIFISCHES MONORACK - MONORACK ESPECÍFICO

YAMAHA FZ1 FAZER 2006

ISTRUZIONI DI MONTAGGIO - MOUNTING INSTRUCTIONS
INSTRUCTIONS DE MONTAGE - BAUANLEITUNG - INSTRUCCIONES DE MONTAJE

I ISTRUZIONI DI MONTAGGIO

- SMONTARE IL CODONE DELLA MOTO AL FINE DI POSIZIONARE I SUPPORTI "2" E "3" COME INDICATO IN FIGURA "A"
DOPO AVER COMPLETATO IL MONTAGGIO DEI DUE SUPPORTI, RIMONTARE IL CODONE ED ESEGUIRE IL MONTAGGIO PROPOSTO IN FIGURA "B".
FISSARE IL MONORACK ALLE PEDALINE DELLA MOTO COME INDICATO IN FIGURA "C" ED INFINE MONTAR LA PIASTRA M5M COME INDICATO IN FIGURA "D".
CONTROLLARE CHE TUTTE LE VITI SIANO SERRATE BENE.

SI RACCOMANDA DI FAR ESEGUIRE IL MONTAGGIO AD UN MECCANICO QUALIFICATO

GB MOUNTING INSTRUCTIONS

1. REMOVE THE TAIL FAIRING OF THE MOTORCYCLE IN ORDER TO POSITION THE SUPPORTS N° 2 AND 3 AS SHOWN IN PICTURE A;
2. AFTER HAVING CARRIED OUT THE MOUNTING OF THE TWO SUPPORTS, REMOUNT THE TAIL FAIRING AND EFFECT THE MOUNTING SUGGESTED IN PICTURE B;
3. FIX THE MONORACK TO THE FOOTRESTS AS SHOWN IN PICTURE C AND MOUNT THE M5M PLATE AS SHOWN IN PICTURE D;
4. LASTLY CHECK THAT ALL SCREWS HAVE BEEN TIGHTENED.

WE RECOMMEND THAT THE MOUNTING IS CARRIED OUT BY A QUALIFIED MOTORCYCLE MECHANIC

F INSTRUCTIONS DE MONTAGE

1. DEMONTER LA COQUE ARRIERE DE LA MOTO AFIN DE POSITIONNER LES PIECES N°2 ET N°3 COMME INDIQUE EN PHOTO A ;
2. APRES AVOIR TERMINER LE MONTAGE DES QUATRE SUPPORTS, REMONTER LA COQUE ARRIERE ET FAIRE LE MONTAGE PROPOSE EN PHOTO B ;
3. FIXER LE MONORACK AUX PLATINES DE REPOSE-PIEDS PASSAGER COMME INDIQUE EN PHOTO C ET, ENSUITE, MONTER LA PLATINE M5M COMME INDIQUE EN PHOTO D ;
4. CONTROLER LE BON SERRAGE DE TOUTES LES VIS.

IL EST RECOMMANDE DE FAIRE REALISER LE MONTAGE PAR UN MECANICIEN QUALIFIE.

D BAUANLEITUNG

1. ENTFERNEN SIE DAS HECK DES FAHRZEUGES UM DIE HALTERUNGEN NR. 2 UND 3 WIE IM BILD A ZU POSITIONIEREN;
2. NACHDEM SIE DIE MONTAGE DER ZWEI HALTERUNGEN DURCHFÜHRT HABEN, MONTIEREN SIE DAS HECK WIEDER AN UND FÜHREN SIE DIE MONTAGE VOM BILD C DURCH;
3. BEFESTIGEN SIE DAS MONORACK AN DEN FUßRASTEN WIE IM BILD C BESCHRIEBEN UND DANACH MONTIEREN SIE DIE M5M PLATTE WIE IM BILD D BESCHRIEBEN;
4. ZULETZT ÜBERPRÜFEN SIE, DASS ALLE SCHRAUBEN FESTGEZOGEN WURDEN.

WIR EMPFEHLEN, DASS DIE MONTAGE VON EINEM FACHMECHANIKER DURCHFÜHRT WIRD.

ES

INSTRUCCIONES DE MONTAJE

1. DESMONTAR EL CARENADO TRASERO DE LA MOTO CON EL FIN DE POSICIONAR EL SOPORTE "2" E "3" COMO ESTA INDICADO EN LA FIGURA "A".
2. DESPUÉS DE COMPLETAR EL MONTAJE DE LOS DOS SOPORTES, VOLVER A MONTAR EL CARENADO TRASERO Y SEGUIR LAS INSTRUCCIONES DE MONTAJE QUE SE MUESTRA EN LA FIGURA "B".
3. FIJAR EL MONORACK AL PEDAL DE LA MOTO TAL Y COMO ILUSTR LA FOTOGRAFÍA "C" Y PARA FINALIZAR MONTAR LA PARRILLA M5M TAL Y COMO ESTA INDICADO EN LA FIGURA "D".
REVISAR QUE TODOS LOS TORNILLOS HAN SIDO APRETADOS CORRECTAMENTE.

LES RECOMENDAMOS QUE EL MONTAJE DE LA DEFENSA SE REALICE POR UN MECÁNICO CALIFICADO