



HUNTSVILLE

SMOOTH WHITE CABINETS PROGRAM



Key Features - Smooth White Program

The Huntsville Smooth White Shaker program offers a complete line up of ready-to-install, Canadian made cabinetry that is designed to suit any style and living space. Its Shaker styling paired with a smooth white matte finish gives you the look and feel of a painted door, without any of the added cost.

Using the included layout grid and cabinet list, start designing your new space today. It can be delivered to store in as little as one week!



Canadian Made

All of our Smooth White cabinetry is manufactured in Barrie, Ontario Canada.



Fully Assembled

Our cabinetry is built and shipped complete to your Cabinetsmith retailer and ready to install.



10-Year Warranty

You have peace of mind with our 10-Year Limited Warranty.



Smooth White

Timeless Shaker Style
Paint-like Smooth Finish
Durable Thermofoil

- A) Reinforced Support Rail
- B) DIY-friendly Adjustable Legs
- C) Soft Close Doors and Drawers
- D) Glue & Dowel Construction

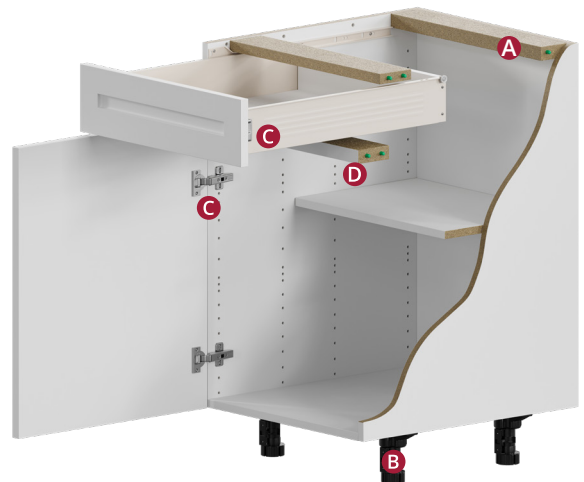

**Exposed base end cabinets will require repositioning of legs to accommodate toe-kick return or purchase of base end panel.*



Huntsville Smooth Shaker White

Cabinet Offering - Base Cabinets

All base cabinets are built to 34 1/2" comfort height. They feature a 5" false front or drawer bank, and adjustable legs.

BASE CABINETS

SINGLE CABINET

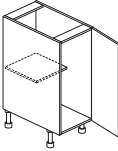
BH09 (L/R)	9"W	
BH12 (L/R)	12"W	
BH13.5 (L/R)	13.5"W	
BH15 (L/R)	15"W	
BH16.5 (L/R)	16.5"W	
BH18 (L/R)	18"W	
BH21 (L/R)	21"W	

DOUBLE CABINET

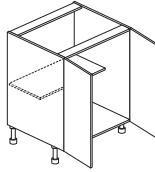
BH24	24"W	
BH27	27"W	
BH30	30"W	
BH33	33"W	
BH36	36"W	

SINGLE DRAWER CABINET

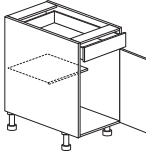
BD12 (L/R)	12"W	
BD13.5 (L/R)	13.5"W	
BD15 (L/R)	15"W	
BD16.5 (L/R)	16.5"W	
BD18 (L/R)	18"W	
BD21 (L/R)	21"W	

DOUBLE DOOR / DRAWER BASE

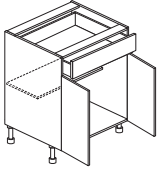
BD24	24"W	
BD27	27"W	
BD30	30"W	
BD33	33"W	
BD36	36"W	

SINK BASE

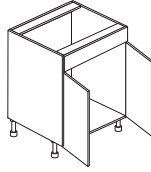
SB24	24"W	
SB27	27"W	
SB30	30"W	
SB33	33"W	
SB36	36"W	

APRON SINK

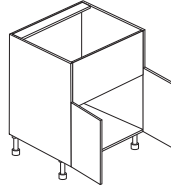
SBAP	30"W	
SBAP33	33"W	
SBAP36	36"W	

3-DRAWER BANK

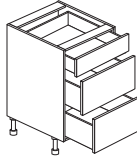
DB12-3	12"W	
DB15-3	15"W	
DB18-3	18"W	
DB21-3	21"W	
DB24-3	24"W	
DB27-3	27"W	
DB30-3	30"W	
DB33-3	33"W	

4-DRAWER BANK

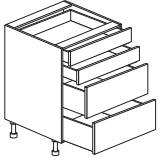
DB12-4	12"W	
DB15-4	15"W	
DB18-4	18"W	

MICROWAVE CABINET

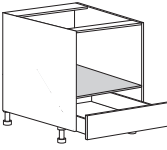
BMD24	24"W	
BMD30	30"W	

COOKTOP BASE

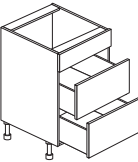
BC30	30"W	
BC33	33"W	

12" D SINGLE CABINET

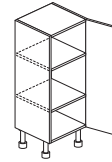
BFH0912 (L/R)	9"W	
BFH1212 (L/R)	12"W	
BFH13.512 (L/R)	13.5"W	
BFH1512 (L/R)	15"W	
BFH16.512 (L/R)	16.5"W	
BFH1812 (L/R)	18"W	
BFH2112 (L/R)	21"W	

12" D DOUBLE CABINET

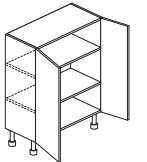
BFH2412	24"W	
BFH2712	27"W	
BFH3012	30"W	
BFH3312	33"W	
BFH3612	36"W	

CORNER CABINETS

EASY REACH CORNER

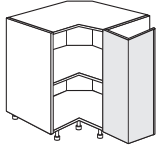
BE33 (L/R)	33"W	
BE36 (L/R)	36"W	

EASY REACH CORNER OFFSET

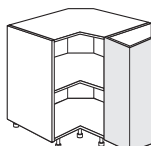
BE33-36 (L/R)	33"W	
BE36-33 (L/R)	36"W	

BLIND CORNER 39" - 48"

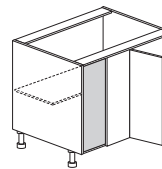
BBH39 (3" pull) L/R	39"W	
BBH42 (6" pull) L/R	42"W	
BBH45 (9" pull) L/R	45"W	
BBH48 (12" pull) L/R	48"W	

BLIND CORNER 51" - 63"

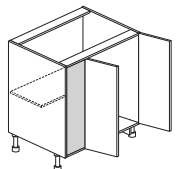
BBH51 (2" pull) L/R	51"W	
BBH54 (6" pull) L/R	54"W	
BSB60 (12" pull) L/R	60"W	
BSB63 (15" pull) L/R	63"W	

TRANSITIONAL END BASE

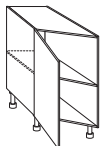
BTE12 (L/R)	12"W	
-------------	------	---

ANGLED SINK CORNER

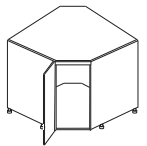
BSA36(L/R)	36"W	
------------	------	---

Cab	Wall Space to Fill	Door Size	Fill Req.	Min Pull	Max Pull
BBH39	39-42"	12"	3"	3"	5"
BBH42	42-44"	15"	3"	6"	8"
BBH45	45-47"	18"	3"	9"	11"
BBH48	48-50"	21"	3"	12"	14"

Cab	Wall Space to Fill	Door Size	Fill Req.	Min Pull	Max Pull
BBH51	51-53"	2X 12"	3"	3"	5"
BBH54	54-56"	2X 13.5"	3"	6"	8"
BSB60	60-62"	2X 16.5"	3"	12"	14"
BSB63	63-65"	2X 18"	3"	15"	17"

OVEN AND PANTRY

24" D | 84,90,94" H BROOM CABINET

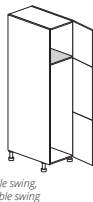
UB1584 (L/R)*	15"W	UB1594 (L/R)*	15"W	
UB1884 (L/R)*	18"W	UB1894 (L/R)*	18"W	
UB2484	24"W	UB2494	24"W	
UB3084	30"W	UB3094	30"W	
UB3384	33"W	UB3394	33"W	
UB1590 (L/R)*	15"W			
UB1890 (L/R)*	18"W			
UB2490	24"W			
UB3090	30"W			
UB3390	33"W			

*15"-18" wide pantries 3 door single swing, 24"-33" wide pantries 6 door double swing

24" D | 84,90,94" H PANTRY CABINET

UP1584 (L/R)*	15"W	UP1594 (L/R)*	15"W	
UP1884 (L/R)*	18"W	UP1894 (L/R)*	18"W	
UP2484	24"W	UP2494	24"W	
UP3084	30"W	UP3094	30"W	
UP3384	33"W	UP3394	33"W	
UP1590 (L/R)*	15"W			
UP1890 (L/R)*	18"W			
UP2490	24"W			
UP3090	30"W			
UP3390	33"W			

*15"-18" wide pantries 3 door single swing, 24"-33" wide pantries 6 door double swing

24" D | 84,90,94" H OVEN CABINET

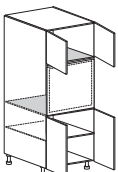
OS3384	33"W	
OS3390	33"W	
OS3394	33"W	

24" D | 84,90,94" H DOUBLE OVEN CABINET

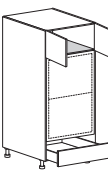
OD3384	33"W	
OD3390	33"W	
OD3394	33"W	

24" D | 84,90,94" H UTILITY HUTCH

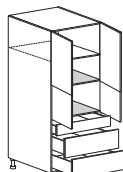
UH1894 (L/R)*	18"W	UH1894 (L/R)*	18"W	
UH2494	24"W	UH2494	24"W	
UH3094	30"W	UH3094	30"W	
UH3394	33"W	UH3394	33"W	
UH1890 (L/R)*	18"W			
UH2490	24"W			
UH3090	30"W			
UH3390	33"W			

*18" wide pantries 2 door single swing, 24"-33" wide pantries 4 door double swing

Cabinet Offering - Wall Cabinets

24" DEEP WALL CABINETS

12" H DOUBLE DOOR WALL

W3012-24 30"W
W3312-24 33"W
W3612-24 36"W

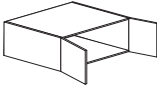

15" H DOUBLE DOOR WALL

W2415-24 24"W
W2715-24 27"W
W3015-24 30"W
W3315-24 33"W
W3615-24 36"W

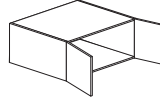

18" H DOUBLE DOOR WALL

W2418-24 24"W
W3018-24 30"W
W3318-24 33"W
W3618-24 36"W

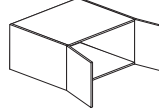

21" H DOUBLE DOOR WALL

W3021-24 30"W
W3321-24 33"W
W3621-24 36"W

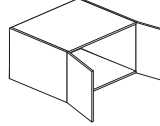

25" H DOUBLE DOOR WALL

W3025-24 30"W
W3325-24 33"W
W3625-24 36"W

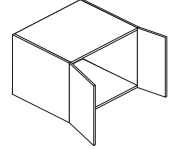

12" DEEP WALL CABINETS

12" H DOUBLE DOOR WALL

W3012 30"W
W3312 33"W
W3612 36"W

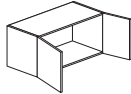

15" H DOUBLE DOOR WALL

W2415 24"W
W2715 27"W
W3015 30"W
W3315 33"W
W3615 36"W

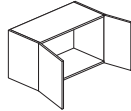

18" H DOUBLE DOOR WALL

W2418 24"W
W3018 30"W
W3318 33"W
W3618 36"W

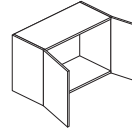

21" H DOUBLE DOOR WALL

W2421 24"W
W3021 30"W
W3321 33"W
W3621 36"W

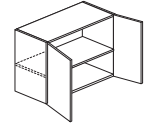

25" H SINGLE DOOR WALL

W1225 (L/R) 12"W
W1525 (L/R) 15"W
W1825 (L/R) 18"W
W2125 (L/R) 21"W

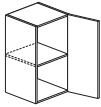

25" H DOUBLE DOOR WALL

W2425 24"W
W2725 27"W
W3025 30"W
W3325 33"W
W3625 36"W

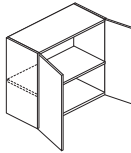

30" H SINGLE DOOR WALL

W0930 (L/R) 9"W
W1230 (L/R) 12"W
W13.530 (L/R) 13.5"W
W1530 (L/R) 15"W
W16.530 (L/R) 16.5"W
W1830 (L/R) 18"W
W2130 (L/R) 21"W

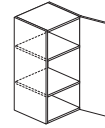

30" H DOUBLE DOOR WALL

W2430 24"W
W2730 27"W
W3030 30"W
W3330 33"W
W3630 36"W

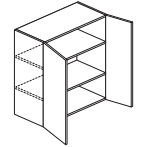

36" H SINGLE DOOR WALL

W0936 (L/R) 9"W
W1236 (L/R) 12"W
W13.536 (L/R) 13.5"W
W1536 (L/R) 15"W
W16.536 (L/R) 16.5"W
W1836 (L/R) 18"W
W2136 (L/R) 21"W

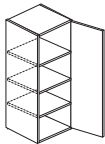

36" H DOUBLE DOOR WALL

W2436 24"W
W2736 27"W
W3036 30"W
W3336 33"W
W3636 36"W

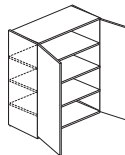

40" H SINGLE DOOR WALL

W0940 (L/R) 9"W
W1240 (L/R) 12"W
W13.540 (L/R) 13.5"W
W1540 (L/R) 15"W
W16.540 (L/R) 16.5"W
W1840 (L/R) 18"W
W2140 (L/R) 21"W

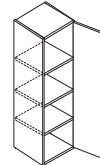

40" H DOUBLE DOOR WALL

W2440 24"W
W2740 27"W
W3040 30"W
W3340 33"W
W3640 36"W

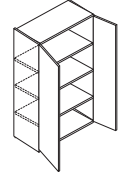

15" H MICROWAVE SHELF

CS-MS2415 24"W

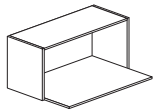

30" H MICROWAVE WALL

WMS2430 24"W

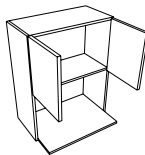

30,36,40" H WALL CORNER

CS-WESC1206-30 12"W
CS-WESC1206-36 12"W
CS-WESC1206-40 12"W

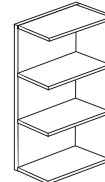

WALL CORNER CABINETS

30,36,40" H ANGLE CORNER WALL

WA2430 (L/R) 12"D
WA2436 (L/R) 12"D
WA2440 (L/R) 12"D

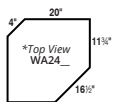
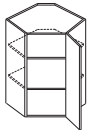

30,36,40" H SINGLE BLIND CORNER

WB2430 (L/R) 24"W
WB2730 (L/R) 27"W
WB3030 (L/R) 30"W
WB3330 (L/R) 33"W
WB3630 (L/R) 36"W

WB2436 (L/R) 24"W
WB2736 (L/R) 27"W
WB3036 (L/R) 30"W
WB3336 (L/R) 33"W
WB3636 (L/R) 36"W

WB2440 (L/R) 24"W
WB2740 (L/R) 27"W
WB3040 (L/R) 30"W
WB3340 (L/R) 33"W
WB3640 (L/R) 36"W

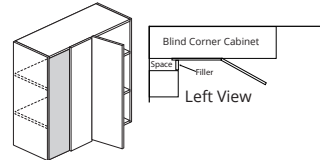

PANELS AND MOULDING

30,40,96,97" H FILLER STRIP

CS-97X6FB-WH 6"W
CS-97X9FB-WH 9"W
CS-30FILLER-WSM 3"W
CS-40FILLER-WSM 3"W
CS-96FILLER-WSM 3"W



84,94" H FRIDGE PANELS

CS-FRIDGE84-WH 24"D
CS-FRIDGE9430-WH 30"D



END PANELS

CS-WEP1230-WH 12"H 30"W
CS-WEP1236-WH 12"H 36"W
CS-WEP1240-WH 12"H 40"W
CS-WEP1530-WH 15"H 30"W
CS-WEP1536-WH 15"H 36"W
CS-WEP1540-WH 15"H 40"W
CS-ISLAND48-WH 48"H 48"W
CS-DWPANEL3625-WH 36"H 25"W



CROWN AND MOULDING

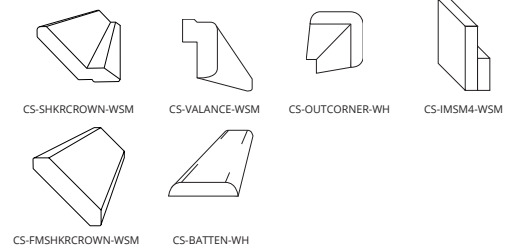

96" H TOE KICK

CS-96TK-WH 4 1/2"W



Design Grid

Use the grid below to layout your new space. Give your design to your Authorized Cabinetsmith Dealer.

Measuring Up Your Layout

Remember to always measure from the outside edge of the door and window trim. Ensure you include all accurate wall measurements.

1. Using the grid supplied to sketch an overhead view of your space. Start at the 0,0 position (upper left corner) and draw outward.
2. Start in the corner of the room and measure the overall dimension of your walls. Write the measurement, in inches, on the shaded area of the grid.
3. Mark the location of all windows and doors noting their width and height including trim.
4. Draw in major appliances noting their outside width, height and depth.
5. Mark the position of plumbing, gas and electrical outlets.
6. Draw in your cabinets and label each one with their corresponding item #.

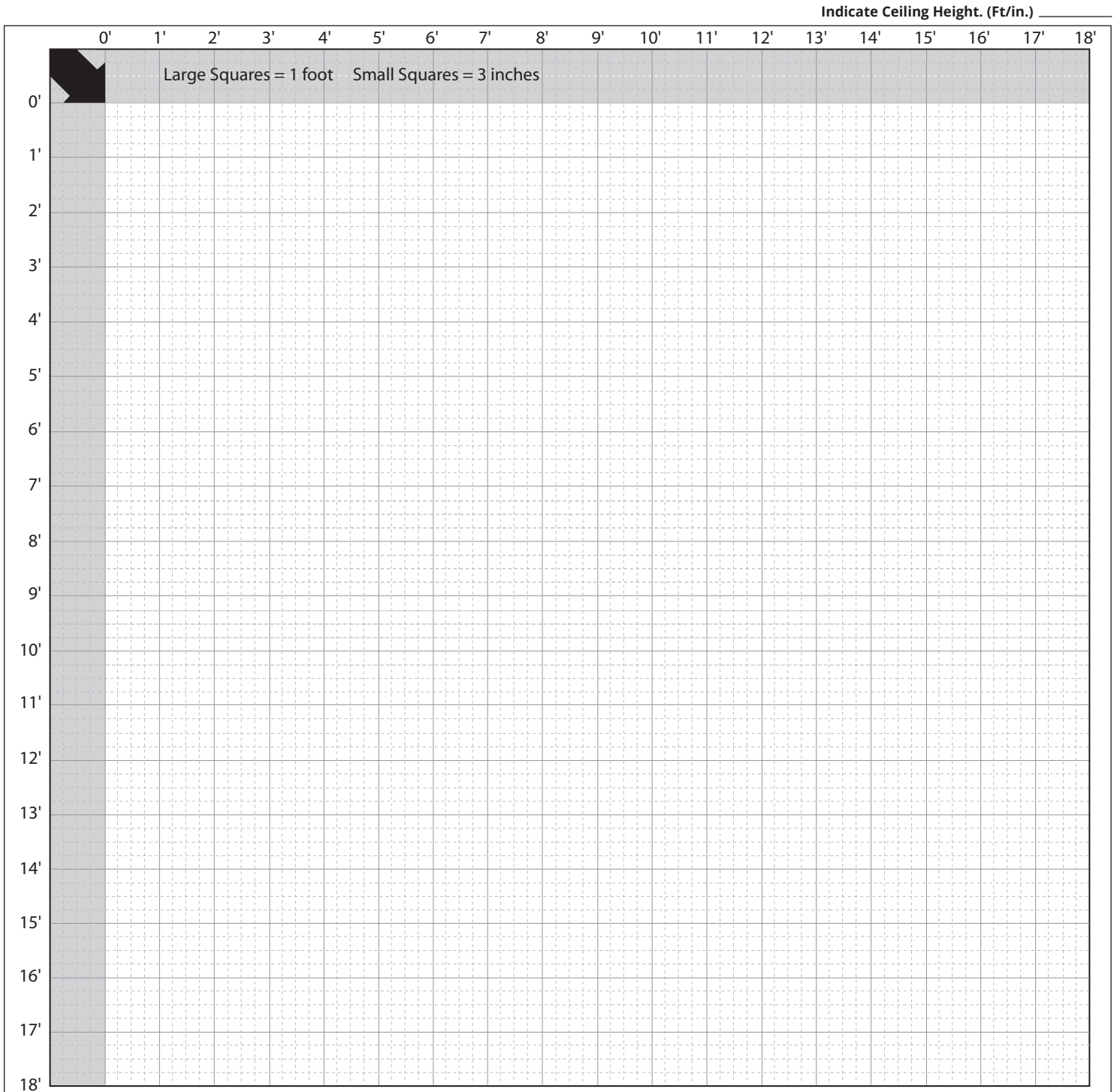



Notable Groups



A national association that strives to promote the interests and conserve the rights of manufacturers of kitchen cabinets, bathroom vanities and related millwork, as well as our suppliers and dealers, throughout Canada.



Ontario Made brings together manufacturers and makers, retailers, and consumers to celebrate and promote the many world-class products that are made right here. We are dedicated to helping consumers identify Ontario-made products, celebrate what is Ontario Made, and support the purchase of Ontario-made products



Well Made Here is a federally chartered non-profit organization. Our commitment is to encourage the purchase of quality building materials and other items manufactured in Canada intended for the residential market.



