

# KC TOOLS<sup>®</sup>

EST. 1975



## PRODUCT CATALOGUE 2019

# Welcome

## Welcome to KC Tools Product Catalogue for 2018

Established in Melbourne in 1975, KC Tools has grown our distribution right across all Australia supplying to over 1000 Industrial and Automotive resellers creating a truly National Brand.

In the early 2000's KC Tools went International and established distributors in New Zealand and Northern Europe. Seeing our brand trusted everywhere from the North Sea Oil Rigs and NATO Air Bases of Europe to the Coal and Iron Ore Mine's in the Australian Outback.

Our focus has always been to supply industrial quality tools at affordable prices to play our part in the critical business of "Keeping the wheels of industry turning". We are committed to continually developing our range with solid, reliable and innovative products, no gimmicks, just tried and tested tools the market needs.

Loyalty and long term relationships are a special feature of our company, we can boast customers that have been with us for 40 years plus.

KC Tools continue's to evolve as a company to meet the demands of the modern customer. Our goal is to remain at the forefront of our industry so our customers enjoy the highest quality tools available.

At the end of the day, whether working on trucks in Mt Isa, a tractor in Mudgee or a tram in Melbourne, we just want to see Professional Trade's Men and Women with the right tools in hand so that they can get the, JOB DONE!

**Yours Sincerely,**  
**The KC Tools Team**  
**KC Tools Group**

## Contact Details

### Australia

#### QLD/NT/SA

34 Granite Street  
Geebung, QLD 4034

**P:** 07 3216 2022

**F:** 07 3216 2033

**E:** sales@kctoolsqld.com.au

#### Victoria/Tasmania

34 Garden Drive  
Tullamarine, VIC 3043

**P:** 03 9335 1122

**F:** 03 9338 0748

**E:** vicadmin@kctools.com.au

#### New South Wales

11 Amax Avenue  
Girraween, NSW 2145

**P:** 02 9896 4933

**F:** 02 9896 4338

**E:** sales@kctnsw.com.au

#### Western Australia

For Sales Contact  
KC Tools Victoria

**P:** 03 9335 1122

**F:** 03 9338 0748

**E:** vicadmin@kctools.com.au

### International

#### New Zealand

Wayco Equipment Ltd  
6 Tironui Road, Papakura  
Auckland 2112

**P:** 09 2962 264

**F:** 09 2962 237

**E:** wayco@xtra.co.nz

#### Norway

Fosen Tools AS  
Industrigata 1, 7130 Brekstad,  
Norway

**P:** 047 7251 5120

**F:** 047 7251 5129

**E:** post@fosen-tools.no



# Contents

1. Tool Kits & Inserts .....	6
2. Tool Boxes & Storage .....	49
3. Socket Sets & Accessories .....	58
4. Spanner Sets & Accessories .....	86
5. Slogging & Podger Spanners .....	105
6. Torque Wrenches .....	264
7. Impact Sockets .....	110
8. Pliers .....	140
9. Adjustable & Pipe Wrenches .....	154
10. Screwdrivers, Hex Keys & Bits .....	158
11. Hammers, Levers & Punches .....	172
12. Hacksaws, Cutters & Knives .....	183
13. Measuring .....	187
14. Air Tools .....	192
15. Automotive & Speciality .....	212
16. Garage & Workshop Equipment .....	238
17. Shadow Boards .....	257
18. A.O.K. .....	262
19. Warranty & Conversion Table .....	298
20. Alphabetical Index .....	300
21. Numerical Index .....	305



**Daniel Carranza Junior Drag Racer**

**KC Tools is Proud to be a sponsorship partner of Batdan Racing**

# Product Ranges



KC Tools offers a wide range of the highest quality professional tools and toolkits, manufactured to Australian and International Standard including ISO 9001 quality management certification.

Choose from our extensive range of over 3,000 quality tools including toolkits, toolboxes, socket sets, spanners, wrenches, air tools, garage and workshop equipment and much, much more. Quality tools that offer excellent value. Tools that enable the most hardened professional and expert tradesman to tackle any job with absolute confidence and backed by our Hassle Free Warranty.

Our tools have been trusted since 1975 in the Construction, Mining, Engineering, Automotive, Electrical, Manufacturing, Farming and Agricultural Industries.



ProAM provides a range of good quality general tools, toolkits and toolboxes ideal for customers seeking a more affordable tool option.

Blue text throughout this catalogue denotes ProAm products.



Established in 1979, AOK is a company concentrating on the Professional Automotive and Industrial markets with its headquarters in Taiwan. AOK is proud to be a global supplier of top quality innovative 'Made-In-Taiwan' professional tools.

AOK has many satisfied customers all over the world including the USA, Canada, Europe, Mexico, Middle East, India, China and Australia. Having accumulated decades of OEM experience, AOK has developed itself a strong and respected private brand.

AOK prides itself on working closely with its industry leading customers and innovative suppliers. AOK applies professional users' feedback to the development of new and better products that provide their customers with uniqueness in their market.

With the belief in quality, consumer oriented Research & Development and complete customised solutions, AOK provides not only a broad and innovative product line to support its industry customers but also builds strategic partnerships with them to add value to products and services that exceed customer expectations.



# KC Tools Online

KC Tools online allows you to stay mobile and in-touch with all the latest news, promotions, retailer locations and information in a phone friendly and easy to navigate format.



**View across your all devices**

**See our latest catalogues**

Our online catalogue is constantly updated with the latest products.





# 1. Tool Kits & Inserts

**Tool up,  
quickly  
and easily.**

KC Tools delivers a complete storage, management and protection system for your tools through our quality range of toolkits to satisfy all levels of experience and budgets.

Whether you're a hardened professional, an apprentice just starting out or a weekend warrior you will find a solution from our toolkit range. We have kits in 5-drawer boxes to 13-drawer Roll Cabinets with heavy duty drawer slides and featuring our unique locking systems. Ute box, cantilever, combination units and wall cabinets allow tools to be organised exactly where you need them to be. KC Tools High Density Foam Insert trays "HDFI" ensure nothing will slide around so you'll always find your tools where you put them last.

Our tool kits and inserts ensure all your tools are quickly and easily accounted for, saving you both time and money.





**ATK158BB**  
**158 Piece Metric & AF Tool Kit**  
**in a 6 Drawer Tool Box**



Available Colours:

**INFERNO**

**JET**

Code	Description
A10052	6 Drawer Tool Box With Ball Bearing Slides (660 x 307 x 377mm)
80135A	High Density Foam Insert Tray
A13330	45PC 1/4" & 3/8" Dr Socket Set Metric & AF
A13170	43PC 1/2" Dr Socket Set Metric & AF
80108	High Density Foam Insert Tray
A13328	24PC Combination Spanner Set Metric & AF
Code	Description
16300	7PC Screwdriver Set
17024	1PC Locking Pliers 250mm
17352	1PC Combination Pliers 200mm
17361	1PC Long Nose Pliers 200mm
17371	1PC Diagonal Cutters 180mm
17380	1PC Multigrips 250mm
A13030	1PC Adjustable Wrench 250mm
14092	1PC Ball Pein Hammer 450g
12404	1PC Knife
10400	1PC 10m Tape Measure
A13060	30PC Hex Key Set Metric & AF



# 1. Tool Kits & Inserts

## ATK218BB

### 218 Piece Metric & AF Tool Kit in a 6 Drawer Tool Box

Code	Description
A10052	6 Drawer Tool Box With Ball Bearing Slides (660 x 307 x 377mm)
80135A	High Density Foam Insert Tray
A13330	45PC 1/4" & 3/8" Dr Socket Set Metric & AF
A13170	43PC 1/2" Dr Socket Set Metric & AF
80000T	High Density Foam Insert Tray
17380	1PC 250mm Multigrip Pliers
17024	1PC 250mm Locking Pliers
40032	1PC 32 Blade End Feeler Gauge
80005T	High Density Foam Insert Tray
17371	1PC 180mm Diagonal Cutters
17352	1PC 200mm Combination Pliers
17361	1PC 200mm Long Nose Pliers
80108T	High Density Foam Insert Tray
A13328	24PC Combination Spanner Set Metric & AF
Code	Description
16300	7PC Screwdriver Set
A13060	30PC Hex Key Set Metric & AF
A13390	54PC Hex & Star Bit Set
A13031	1PC Adjustable Wrench 300mm
14092	1PC 450g Ball Pein Hammer
16240	6PC Precision Screwdriver Set
12265	1PC 300mm Hacksaw

Available Colours:



**INFERNO**

**JET**





## ATK79BB

### 262 Piece Metric & AF Tool Kit in a 9 Drawer Tool Box

Code	Description
A10059	9 Drawer Tool Box With Ball Bearing Slides (660 x 308 x 435mm)
<b>80135T</b>	<b>High Density Foam Insert Tray</b>
A13330	45PC 1/4" & 3/8" Dr Socket Set Metric & AF
A13170	43PC 1/2" Dr Socket Set Metric & AF
<b>80000T</b>	<b>High Density Foam Insert Tray</b>
17380	1PC 250mm Multigrip Pliers
17024	1PC 250mm Locking Pliers
40032	1PC 32 Blade End Feeler Gauge
<b>80005T</b>	<b>High Density Foam Insert Tray</b>
17371	1PC 180mm Diagonal Cutters
17352	1PC 200mm Combination Pliers
17361	1PC 200mm Long Nose Pliers
<b>80010T</b>	<b>High Density Foam Insert Tray</b>
16310	1PC 3.0 x 75mm Screwdriver
16312	1PC 4.0 x 100mm Screwdriver
16313	1PC 5.5 x 125mm Screwdriver
16314	1PC 6.5 x 150mm Screwdriver
16321	1PC 6.5 x 25mm Stubby Screwdriver
16340	1PC No.0 x 60mm Screwdriver
16341	1PC No.1 x 80mm Screwdriver
16343	1PC No.2 x 100mm Screwdriver
16350	1PC No.2 x 25mm Stubby Screwdriver
<b>80100T</b>	<b>High Density Foam Insert Tray</b>
16250	1PC Offset Screwdriver
16316	1PC 10.0 x 200mm Screwdriver
16315	1PC 8.0 x 150mm Screwdriver
16348	1PC No.3 x 150mm Screwdriver
16344	1PC No.2 x 200mm Screwdriver
A13145	6PC Ring Spanner Set Metric
A13290	6PC Open End Spanner Set Metric
A13336	12PC Comb Spanner Set Metric
A13520	1PC 10mm XS Comb Spanner
A13521	1PC 11mm XS Comb Spanner
A13522	1PC 12mm XS Comb Spanner
A13523	1PC 13mm XS Comb Spanner
A13524	1PC 14mm XS Comb Spanner
<b>80105T</b>	<b>High Density Foam Insert Tray</b>
16240	6PC Precision Screwdriver Set
12601	5PC Screw Extractor Set
A13140	6PC Ring Spanner Set AF
A13285	6PC Open End Spanner Set AF
A13334	12PC Combination Spanner Set AF
A13510	1PC 3/8" XS Comb Spanner
A13511	1PC 7/16" XS Comb Spanner
A13512	1PC 1/2" XS Comb Spanner
A13513	1PC 9/16" XS Comb Spanner
<b>Code</b>	<b>Description</b>
A13395	28PC Hex & Star Bit Set
A13060	30PC Hex Key Set
A7200	8PC Long Pin Punch Set
A7100	7PC Punch & Chisel Set
A13542	3PC Flare Nut Spanner Set Metric
A13537	3PC Flare Nut Spanner Set AF
A13028	1PC 150mm Adjustable Wrench
A13029	1PC 200mm Adjustable Wrench
A13031	1PC 300mm Adjustable Wrench
14092	1PC 16oz/450g Ball Pein Hammer
07118	1PC 375mm Podger Bar
40026	1PC 13mm Brake Adjuster
12265	1PC 300mm Deluxe Hacksaw

Available Colours:



**INFERNO**

**JET**



# 1. Tool Kits & Inserts

## ATK610D

### 262 Piece Metric & AF Tool Kit in a 10 Drawer Tool Box

Code	Description
A22104	10 Drawer Tool Box With Ball Bearing Slides (712 x 472 x 474mm)
80800D-1	High Density Foam Insert Tray
A13330	45PC 1/4" & 3/8" Dr Socket Set Metric & AF
A13170	43PC 1/2" Dr Socket Set Metric & AF
80800D-2	High Density Foam Insert Tray
16250	1PC Offset Screwdriver Blade 5.5, Phillips No.2
16316	1PC 10 x 200mm Screwdriver
16315	1PC 8.0 x 150mm Screwdriver
16348	1PC No.3 x 150mm Screwdriver
16344	1PC No.2 x 200mm Screwdriver
80800D-3	High Density Foam Insert Tray
16310	1PC 3.0 x 75mm Screwdriver
16312	1PC 4.0 x 100mm Screwdriver
16313	1PC 5.5 x 125mm Screwdriver
16314	1PC 6.5 x 150mm Screwdriver
16321	1PC 6.5 x 25mm Stubby Screwdriver
16340	1PC No.0 x 60mm Screwdriver
16341	1PC No.1 x 80mm Screwdriver
16343	1PC No.2 x 100mm Screwdriver
16350	1PC No.2 x 25mm Stubby Screwdriver
80800D-4	High Density Foam Insert Tray
17380	1PC Multigrips 250mm
17024	1PC Locking Pliers 250mm
40032	1PC 32 Blade End Feeler Gauge
17371	1PC Diagonal Cutters 180mm
17352	1PC Combination Pliers 200mm
17361	1PC Long Nose Pliers 200mm
80800D-5	High Density Foam Insert Tray
A13028	1PC Adjustable Wrench 150mm
A13029	1PC Adjustable Wrench 200mm
A13031	1PC Adjustable Wrench 300mm
A13145	6PC Ring Spanner Set Metric
A13290	6PC Open End Spanner Set Metric
A13336	12PC Combination Spanner Set Metric
A13520	1PC 10mm XS Comb Spanner
A13521	1PC 11mm XS Comb Spanner
A13522	1PC 12mm XS Comb Spanner
A13523	1PC 13mm XS Comb Spanner
A13524	1PC 14mm XS Comb Spanner
A13542	3PC Flare Nut Spanner Set Metric
80800D-6	High Density Foam Insert Tray
A13334	12PC Combination Spanner Set AF
A13510	1PC 3/8" XS Comb Spanner
A13511	1PC 7/16" XS Comb Spanner
A13512	1PC 1/2" XS Comb Spanner
A13513	1PC 9/16" XS Comb Spanner
A13537	3PC Flare Nut Spanner Set AF
A13285	6PC Open End Spanner Set AF
A13140	6PC Ring Spanner Set AF
<b>Tools included not in insert</b>	
A13395	28PC Hex & Star Bit Set
A13060	30PC Hex Key Set
A7200	8PC Long Pin Punch Set
A7100	7PC Punch and Chisel Set
16240	6PC Precision Screwdriver Set
14092	1PC Ball Pein Hammer 450g
07118	1PC Podger Bar 450mm
40026	1PC Break Adjuster
12265	1PC 300mm Hacksaw
12601	5PC Screw Extractor Set





**ATK322**

**322 Piece Metric & AF Tool Kit in a 7 Drawer Tool Box & 11 Drawer Roll Cabinet With 6 HDFI Deep Inserts**

Code	Description
A12107B	7 Drawer Tool Box with Ball Bearing Slides (1051 x 445 x 552)
A12111B	11 Drawer Roll Cabinet with Ball Bearing Slides (1067 x 408 x 909)
80800D-1	High Density Foam Insert Tray
A13330	45PC 1/4" & 3/8" Dr Socket Set Metric & AF
A13170	43PC 1/2" Dr Socket Set Metric & AF
80800D-2	High Density Foam Insert Tray
16250	1PC Offset Screwdriver
16315	1PC 8.0 x 150mm Screwdriver
16316	1PC 10.0 x 200mm Screwdriver
16344	1PC No.2 x 200mm Screwdriver
16348	1PC No.3 x 150mm Screwdriver
80800D-3	High Density Foam Insert Tray
16310	1PC 3.0 x 75mm Screwdriver
16312	1PC 4.0 x 100mm Screwdriver
16313	1PC 5.5 x 125mm Screwdriver
16314	1PC 6.5 x 150mm Screwdriver
16321	1PC 6.5 x 25mm Screwdriver
16340	1PC No.0 x 60mm Screwdriver
16341	1PC No.1 x 80mm Screwdriver
16343	1PC No.2 x 100mm Screwdriver
16350	1PC No.2 x 25mm Screwdriver
80800D-4	High Density Foam Insert Tray
17385	1PC 250mm Multigrip Pliers
17024	1PC 250mm Locking Pliers
40032	1PC 32 Blade End Feeler Gauge
17371	1PC Diagonal Cutters 180mm
17352	1PC Combination Pliers 200mm
17361	1PC Long Nose Pliers 200mm
80800D-5	High Density Foam Insert Tray
A13028	1PC 150mm Adjustable Wrench
A13029	1PC 200mm Adjustable Wrench
A13031	1PC 300mm Adjustable Wrench
A13145	6PC Ring Spanner Set Metric
A13290	6PC Open End Spanner Set Met
A13336	12PC Comb Spanner Set Metric
A13520	1PC 10mm XS Comb Spanner
A13521	1PC 11mm XS Comb Spanner
A13522	1PC 12mm XS Comb Spanner
A13523	1PC 13mm XS Comb Spanner
A13524	1PC 14mm XS Comb Spanner
A13542	3PC Flare Nut Spanner Set Metric
80800D-6	High Density Foam Insert Tray
A13334	12PC Comb Spanner Set AF
A13510	1PC 3/8" XS Comb Spanner
A13511	1PC 7/16" XS Comb Spanner
A13512	1PC 1/2" XS Comb Spanner
A13513	1PC 9/16" XS Comb Spanner
A13537	3PC Flare Nut Spanner Set AF
A13140	6PC Ring Spanner Set AF
A13285	6PC Open End Spanner Set AF
Code	Description
07118	450mm Podger Bar
10664	33PC Bit Set, Tamperproof
12265	300mm Hacksaw
12601	5PC Screw Extractor
16240	6PC Precision Screwdriver Set
40026	8mm Brake Adjuster
A7100	7PC Punch & Chisel Set
A7200	8PC Punch & Chisel Set
A13060	30PC Hex Key Set AF & Metric
A13390	54PC Bit Set, Hex & Star
AZDA317	1/2" DR Flex Head Bar 600mm



# 1. Tool Kits & Inserts

## ATK322BB & TB

**322PC AF & Metric Toolkit  
In Either 11 Roll Cabinet (BB)  
Or 7 Drawer Tool Box (TB)**

Code	Description
A12107B	7 Drawer Tool Box with Ball Bearing Slides (1051 x 445 x 552mm)
A12111B	11 Drawer Roll Cabinet with Ball Bearing Slides (1067 x 480 x 909mm)
80800D-1	High Density Foam Insert Tray
A13330	45PC 1/4" & 3/8" Dr Socket Set Metric & AF
A13170	43PC 1/2" Dr Socket Set Metric & AF
80800D-2	High Density Foam Insert Tray
16250	1PC Offset Screwdriver
16315	1PC 8.0 x 150mm Screwdriver
16316	1PC 10.0 x 200mm Screwdriver
16344	1PC No.2 x 200mm Screwdriver
16348	1PC No.3 x 150mm Screwdriver
80800D-3	High Density Foam Insert Tray
16310	1PC 3.0 x 75mm Screwdriver
16312	1PC 4.0 x 100mm Screwdriver
16313	1PC 5.5 x 125mm Screwdriver
16314	1PC 6.5 x 150mm Screwdriver
16321	1PC 6.5 x 25mm Screwdriver
16340	1PC No.0 x 60mm Screwdriver
16341	1PC No.1 x 80mm Screwdriver
16343	1PC No.2 x 100mm Screwdriver
16350	1PC No.2 x 25mm Screwdriver
80800D-4	High Density Foam Insert Tray
17385	1PC 250mm Multigrip Pliers
17024	1PC 250mm Locking Pliers
40032	1PC 32 Blade End Feeler Gauge
17371	1PC Diagonal Cutters 180mm
17352	1PC Combination Pliers 200mm
17361	1PC Long Nose Pliers 200mm
80800D-5	High Density Foam Insert Tray
A13028	1PC 150mm Adjustable Wrench
A13029	1PC 200mm Adjustable Wrench
A13031	1PC 300mm Adjustable Wrench
A13145	6PC Ring Spanner Set Metric
A13290	6PC Open End Spanner Set Metric
A13336	12PC Comb Spanner Set Metric
A13520	1PC 10mm XS Comb Spanner
A13521	1PC 11mm XS Comb Spanner
A13522	1PC 12mm XS Comb Spanner
A13523	1PC 13mm XS Comb Spanner
A13524	1PC 14mm XS Comb Spanner
A13542	3PC Flare Nut Spanner Set Metric
80800D-6	High Density Foam Insert Tray
A13334	12PC Comb Spanner Set AF
A13510	1PC 3/8" XS Comb Spanner
A13511	1PC 7/16" XS Comb Spanner
A13512	1PC 1/2" XS Comb Spanner
A13513	1PC 9/16" XS Comb Spanner
A13537	3PC Flare Nut Spanner Set AF
A13140	6PC Ring Spanner Set AF
A13285	6PC Open End Spanner Set AF
	<b>Description</b>
07118	450mm Podger Bar
10664	33PC Bit Set, Tamperproof
12265	300mm Hacksaw
12601	5PC Screw Extractor
16240	6PC Precision Screwdriver Set
40026	8mm Brake Adjuster
A7100	7PC Punch & Chisel Set
A7200	8PC Punch & Chisel Set
A13060	30PC Hex Key Set AF & Metric
A13390	54PC Bit Set, Hex & Star
AZDA317	1/2" DR Flex Head Bar 600mm

**ATK322BB**



**ATK322TB**





**ATK338BB**

**338 Piece Metric & AF Tool Kit in a 6 Drawer Tool Box & a 6 Drawer Roll Cabinet With 7 HDFI Inserts**



**INFERNO**

**JET**

Code	Description
A10052	6 Drawer Tool Box With Ball Bearing Slides (660 x 307 x 377mm)
A10056	7 Drawer Roll Cabinet With Ball Bearing Slides (680 x 458 x 995mm)
80135T	High Density Foam Insert Tray
A13330	45PC 1/4" & 3/8" Dr Socket Set Metric & AF
A13170	43PC 1/2" Dr Socket Set Metric & AF
80000T	High Density Foam Insert Tray
17380	1PC 250mm Multigrip Pliers
17024	1PC 250mm Locking Pliers
40032	1PC 32 Blade End Feeler Gauge
80005T	High Density Foam Insert Tray
17371	1PC 180mm Diagonal Cutters
17352	1PC 200mm Combination Pliers
17361	1PC 200mm Long Nose Pliers
80010T	High Density Foam Insert Tray
16310	1PC 3.0 x 75mm Screwdriver
16312	1PC 4.0 x 100mm Screwdriver
16313	1PC 5.5 x 125mm Screwdriver
16314	1PC 6.5 x 150mm Screwdriver
16321	1PC 6.5 x 25mm Stubby Screwdriver
16340	1PC No.0 x 60mm Screwdriver
16341	1PC No.1 x 80mm Screwdriver
16343	1PC No.2 x 100mm Screwdriver
16350	1PC No.2 x 25mm Stubby Screwdriver
80100T	High Density Foam Insert Tray
16250	1PC Offset Screwdriver
16316	1PC 10.0 x 200mm Screwdriver
16315	1PC 8.0 x 150mm Screwdriver
16348	1PC No.3 x 150mm Screwdriver
16344	1PC No.2 x 200mm Screwdriver
A13145	6PC Ring Spanner Set Metric
A13290	6PC Open End Spanner Set Metric
A13336	12PC Comb Spanner Set Metric
A13520	1PC 10mm XS Comb Spanner
A13521	1PC 11mm XS Comb Spanner
A13522	1PC 12mm XS Comb Spanner
A13523	1PC 13mm XS Comb Spanner
A13524	1PC 14mm XS Comb Spanner
80105T	High Density Foam Insert Tray
16240	6PC Precision Screwdriver Set
12601	5PC Screw Extractor Set
A13140	6PC Ring Spanner Set AF
A13285	6PC Open End Spanner Set AF
A13334	12PC Combination Spanner Set AF
A13510	1PC 3/8" XS Comb Spanner
A13511	1PC 7/16" XS Comb Spanner
A13512	1PC 1/2" XS Comb Spanner
A13513	1PC 9/16" XS Comb Spanner
<b>Tools included not in insert</b>	
RSK-8	8PC Gear Ratchet Spanner Set AF
RSK-8i	8PC Gear Ratchet Spanner Set Met
A13542	3PC Flare Nut Spanner Set Metric
A13537	3PC Flare Nut Spanner Set AF
A13395	28PC Hex & Star Bit Set
A13060	30PC Hex Key Set Metric & AF
A7200	8PC Long Pin Punch Set
A7100	7PC Punch & Chisel Set
12009	60PC Tap & Die Set
A13028	1PC Adjustable Wrench 150mm
A13029	1PC Adjustable Wrench 200mm
A13031	1PC Adjustable Wrench 300mm
14092	1PC 450g Ball Pein Hammer
07118	1PC 450mm Podger Bar
40026	1PC 8mm Brake Adjuster
12265	1PC 300mm Hacksaw
12404	1PC Auto Loading Utility Knife
10400	1PC 10m Tape Measure



1. Tool Kits & Inserts



# 1. Tool Kits & Inserts

## ATK409BB

**409 Piece Metric & AF Tool Kit in a 10 Drawer Tool Box & a 7 Drawer Roll Cabinet With 8 HDFI Deep Inserts**

Code	Description
A22104	10 Drawer Tool Box with Ball Bearing Slides (712 x 472 x 474mm)
A22112	7 Drawer Roll Cabinet with Ball Bearing Slides (721 x 472 x 1010mm)
80800D-1	High Density Foam Insert Tray
A13330	45PC 1/4" & 3/8" Dr Socket Set Metric & AF
A13170	43PC 1/2" Dr Socket Set Metric & AF
80800D-2	High Density Foam Insert Tray
16250	1PC Offset Screwdriver
16315	1PC 8.0 x 150mm Screwdriver
16316	1PC 10.0 x 200mm Screwdriver
16344	1PC No.2 x 200mm Screwdriver
16348	1PC No.3 x 150mm Screwdriver
80800D-3	High Density Foam Insert Tray
16310	1PC 3.0 x 75mm Screwdriver
16312	1PC 4.0 x 100mm Screwdriver
16313	1PC 5.5 x 125mm Screwdriver
16314	1PC 6.5 x 150mm Screwdriver
16321	1PC 6.5 x 25mm Screwdriver
16340	1PC No.0 x 60mm Screwdriver
16341	1PC No.1 x 80mm Screwdriver
16343	1PC No.2 x 100mm Screwdriver
16350	1PC No.2 x 25mm Screwdriver
80800D-4	High Density Foam Insert Tray
17380	1PC 250mm Multigrip Pliers
17024	1PC 250mm Locking Pliers
40032	1PC 32 Blade End Feeler Gauge
17371	1PC Diagonal Cutters 180mm
17352	1PC Combination Pliers 200mm
17361	1PC Long Nose Pliers 200mm
80800D-10	High Density Foam Insert Tray
RSK-8i	7PC Gear Ratchet Spanner Set AF
RSK-8	7PC Gear Ratchet Spanner Set Met
80800D-5	High Density Foam Insert Tray
A13028	1PC 150mm Adjustable Wrench
A13029	1PC 200mm Adjustable Wrench
A13031	1PC 300mm Adjustable Wrench
A13145	6PC Ring Spanner Set Metric
A13290	6PC Open End Spanner Set Metric
A13336	12PC Comb Spanner Set Metric
A13520	1PC 10mm XS Comb Spanner
A13521	1PC 11mm XS Comb Spanner
A13522	1PC 12mm XS Comb Spanner
A13523	1PC 13mm XS Comb Spanner
A13524	1PC 14mm XS Comb Spanner
A13542	3PC Flare Nut Spanner Set Metric
80800D-6	High Density Foam Insert Tray
A13334	12PC Comb Spanner Set AF
A13510	1PC 3/8" XS Comb Spanner
A13511	1PC 7/16" XS Comb Spanner
A13512	1PC 1/2" XS Comb Spanner
A13513	1PC 9/16" XS Comb Spanner
A13537	3PC Flare Nut Spanner Set AF
A13140	6PC Ring Spanner Set AF
A13285	6PC Open End Spanner Set AF
80196	High Density Foam Insert Tray
A13362	26PC 3/4" Dr Socket Set Metric & AF
Code	Description
ACM22	1PC 22mm Comb Spanner
ACM23	1PC 23mm Comb Spanner
ACM24	1PC 24mm Comb Spanner
ACM25	1PC 25mm Comb Spanner
ACM26	1PC 26mm Comb Spanner
ACM27	1PC 27mm Comb Spanner

Code	Description
ACM30	1PC 30mm Comb Spanner
ACM32	1PC 32mm Comb Spanner
AC32	1PC 1" Comb Spanner
AC34	1PC 1-1/16" Comb Spanner
AC36	1PC 1-1/8" Comb Spanner
AC40	1PC 1-1/4" Comb Spanner
AC42	1PC 1-5/16" Comb Spanner
AC44	1PC 1-3/8" Comb Spanner
AC46	1PC 1-7/16" Comb Spanner
AC48	1PC 1-1/2" Comb Spanner
17674	4PC Circlip Plier Set 230mm
13668	10PC 1/2" Dr In-Hex Socket Set AF
13669	10PC 1/2" Dr In-Hex Socket Set Metric
16240	6PC Precision Screwdriver Set
10700	4PC Rolling Head Pry Bar Set
A13395	28PC Hex & Star Bit Set
A13060	30PC Hex Key Set Metric & AF
A7200	8PC Long Pin Punch Set
A7100	7PC Punch & Chisel Set
12601	5PC Screw Extractor Set
12404	1PC Utility Knife
10400	1PC 10m Tape Measure
17255	1PC Gasket Scissors
14092	1PC 450g Ball Pein Hammer
07118	1PC 450mm Podger Bar
40026	1PC 8mm Brake Adjuster
12265	1PC 300mm Hacksaw
12009	60PC Tap & Die Set

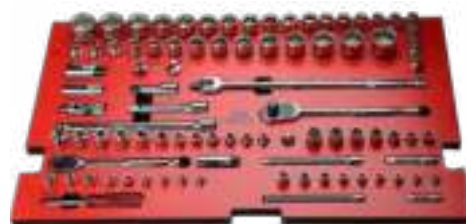





INFERNO

FLAME

JET



# 1. Tool Kits & Inserts

## ATK523DBB

**523 Piece Metric & AF Tool Kit in a 10 Drawer Tool Box & a 7 Drawer Roll Cabinet With 8 HDFI Deep Inserts**

Code	Description
A22104	10 Drawer Tool Box with Ball Bearing Slides (712 x 472x 474mm)
A22112	7 Drawer Roll Cabinet with Ball Bearing Slides (712 x 472 x 1010mm)
<b>80800D-1</b>	<b>High Density Foam Insert Tray</b>
A13330	45PC 1/4" & 3/8" Dr Socket Set Metric & AF
A13170	43PC 1/2" Dr Socket Set Met & AF
<b>80800D-2</b>	<b>High Density Foam Insert Tray</b>
16250	1PC Offset Screwdriver
16315	1PC 8.0 x 150mm Screwdriver
16316	1PC 10.0 x 200mm Screwdriver
16344	1PC No.2 x 200mm Screwdriver
16348	1PC No.3 x 150mm Screwdriver
<b>80800D-3</b>	<b>High Density Foam Insert Tray</b>
16310	1PC 3.0 x 75mm Screwdriver
16350	1PC No.2 x 25mm Screwdriver
16312	1PC 4.0 x 100mm Screwdriver
16313	1PC 5.5 x 125mm Screwdriver
16314	1PC 6.5 x 150mm Screwdriver
16321	1PC 6.5 x 25mm Screwdriver
16340	1PC No.0 x 60mm Screwdriver
16341	1PC No.1 x 80mm Screwdriver
16343	1PC No.2 x 100mm Screwdriver
<b>80800D-4</b>	<b>High Density Foam Insert Tray</b>
17380	1PC 250mm Multigrip Pliers
17024	1PC 250mm Locking Pliers
40032	1PC 32 Blade End Feeler Gauge
17371	1PC Circlip Pliers 180mm
17352	1PC Combination Pliers 200mm
17361	1PC Long Nose Pliers 200mm
<b>80800D-10</b>	<b>High Density Foam Insert Tray</b>
RSK-8i	7PC Gear Ratchet Spanner Set AF
RSK-8	7PC Gear Ratchet Spanner Set Met
<b>80800D-5</b>	<b>High Density Foam Insert Tray</b>
A13028	1PC 150mm Adjustable Wrench
A13029	1PC 200mm Adjustable Wrench
A13031	1PC 300mm Adjustable Wrench
A13145	6PC Ring Spanner Set Metric
A13290	6PC Open End Spanner Set Metric
A13336	12PC Comb Spanner Set Metric
A13520	1PC 10mm XS Comb Spanner
A13521	1PC 11mm XS Comb Spanner
A13522	1PC 12mm XS Comb Spanner
A13523	1PC 13mm XS Comb Spanner
A13524	1PC 14mm XS Comb Spanner
A13542	3PC Flare Nut Spanner Set Metric
<b>80800D-6</b>	<b>High Density Foam Insert Tray</b>
A13334	12PC Comb Spanner Set AF
A13510	1PC 3/8" XS Comb Spanner
A13511	1PC 7/16" XS Comb Spanner
A13512	1PC 1/2" XS Comb Spanner
A13513	1PC 9/16" XS Comb Spanner
A13537	3PC Flare Nut Spanner Set AF
A13140	6PC Ring Spanner Set AF
A13285	6PC Open End Spanner Set AF
<b>80196</b>	<b>High Density Foam Insert Tray</b>
A13362	26PC 3/4" Dr Socket Set Met & AF
<b>Code</b>	<b>Description</b>
ACM22	1PC 22mm Comb Spanner
ACM23	1PC 23mm Comb Spanner
ACM24	1PC 24mm Comb Spanner
ACM25	1PC 25mm Comb Spanner
ACM26	1PC 26mm Comb Spanner
ACM27	1PC 27mm Comb Spanner
ACM30	1PC 30mm Comb Spanner

Code	Description
ACM32	1PC 32mm Comb Spanner
AC32	1PC 1" Comb Spanner
AC34	1PC 1-1/16" Comb Spanner
AC36	1PC 1-1/8" Comb Spanner
AC40	1PC 1-1/4" Comb Spanner
AC42	1PC 1-5/16" Comb Spanner
AC44	1PC 1-3/8" Comb Spanner
AC46	1PC 1-7/16" Comb Spanner
AC48	1PC 1-1/2" Comb Spanner
17674	4PC Circlip Plier Set 230mm
13668	10PC 1/2" Dr In-Hex Socket Set AF
13669	10PC 1/2" Dr In-Hex Socket Set Metric
11320	20PC 1/2" Dr Impact Socket Set AF
11321	20PC 1/2" Dr Impact Socket Set Metric
10617	9PC Hex Key Set AF
10616	9PC Hex Key Set Metric
PT52	110PC Tap & Die Set
16240	6PC Precision Screwdriver Set
10700	4PC Rolling Head Pry Bar Set
A13395	28PC Hex & Star Bit Set
A13060	30PC Hex Key Set Metric & AF
A7100	7PC Punch & Chisel Set
A7200	8PC Long Pin Punch Set
12601	5PC Screw Extractor Set
12404	1PC Auto Loading Utility Knife
10400	1PC 10m Tape Measure
17255	1PC Gasket Scissors
15102	1PC 450mm Bolt Cutter
15122	1PC 450mm Pipe Wrench
A13030	1PC Adjustable Wrench 250mm
A13032	1PC Adjustable Wrench 375mm
14092	1PC 450g Ball Pein Hammer
14093	1PC 650g Ball Pein Hammer
14094	1PC 900g Ball Pein Hammer
07118	1PC 450mm Podger Bar
40026	1PC 8mm Brake Adjuster
12265	1PC 300mm Hacksaw

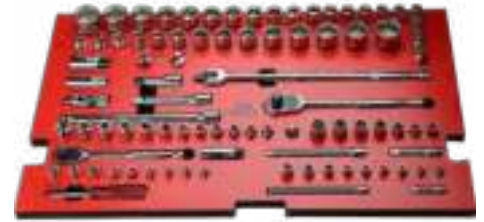





**INFERNO** **FLAME** **JET**



# 1. Tool Kits & Inserts

## ATK523RBB

### 523 Piece Metric & AF Tool Kit in a 11 Drawer Roll Cabinet With 8 HDFI Deep Inserts

Code	Description
A12171	11 Drawer Roll Cabinet With Ball Bearing Slides (1067 x 458 x 1007mm)
80800D-1	High Density Foam Insert Tray
A13330	45PC 1/4" & 3/8" Dr Socket Set Metric & AF
A13170	43PC 1/2" Dr Socket Set Metric & AF
80800D-2	High Density Foam Insert Tray
16250	1PC Offset Screwdriver
16315	1PC 8.0 x 150mm Screwdriver
16316	1PC 10.0 x 200mm Screwdriver
16344	1PC No.2 x 200mm Screwdriver
16348	1PC No.3 x 150mm Screwdriver
80800D-3	High Density Foam Insert Tray
16310	1PC 3.0 x 75mm Screwdriver
16350	1PC No.2 x 25mm Screwdriver
16312	1PC 4.0 x 100mm Screwdriver
16313	1PC 5.5 x 125mm Screwdriver
16314	1PC 6.5 x 150mm Screwdriver
16321	1PC 6.5 x 25mm Screwdriver
16340	1PC No.0 x 60mm Screwdriver
16341	1PC No.1 x 80mm Screwdriver
16343	1PC No.2 x 100mm Screwdriver
80800D-4	High Density Foam Insert Tray
17380	1PC 250mm Multigrip Pliers
17024	1PC 250mm Locking Pliers
40032	1PC 32 Blade End Feeler Gauge
17371	1PC Diagonal Cutters 180mm
17352	1PC Combination Pliers 200mm
17361	1PC Long Nose Pliers 200mm
80800D-5	High Density Foam Insert Tray
A13028	1PC 150mm Adjustable Wrench
A13029	1PC 200mm Adjustable Wrench
A13031	1PC 300mm Adjustable Wrench
A13145	6PC Ring Spanner Set Metric
A13290	6PC Open End Spanner Set Metric
A13336	12PC Comb Spanner Set Metric
A13520	1PC 10mm XS Comb Spanner
A13521	1PC 11mm XS Comb Spanner
A13522	1PC 12mm XS Comb Spanner
A13523	1PC 13mm XS Comb Spanner
A13524	1PC 14mm XS Comb Spanner
A13542	3PC Flare Nut Spanner Set Metric
80800D-6	High Density Foam Insert Tray
A13334	12PC Comb Spanner Set AF
A13510	1PC 3/8" XS Comb Spanner
A13511	1PC 7/16" XS Comb Spanner
A13512	1PC 1/2" XS Comb Spanner
A13513	1PC 9/16" XS Comb Spanner
A13537	3PC Flare Nut Spanner Set AF
A13140	6PC Ring Spanner Set AF
A13285	6PC Open End Spanner Set AF
80196	High Density Foam Insert Tray
A13362	26PC 3/4" Dr Socket Set Met & AF
80800D-10	High Density Foam Insert Tray
RSK-8i	8PC Gear Ratchet Spanner Set AF
RSK-8	8PC Gear Ratchet Spanner Set Met
Code	Description
ACM22	1PC 22mm Comb Spanner
ACM23	1PC 23mm Comb Spanner
ACM24	1PC 24mm Comb Spanner
ACM25	1PC 25mm Comb Spanner
ACM26	1PC 26mm Comb Spanner
ACM27	1PC 27mm Comb Spanner
ACM30	1PC 30mm Comb Spanner
ACM32	1PC 32mm Comb Spanner
AC32	1PC 1" Comb Spanner
AC34	1PC 1-1/16" Comb Spanner

Code	Description
AC36	1PC 1-1/8" Comb Spanner
AC40	1PC 1-1/4" Comb Spanner
AC42	1PC 1-5/16" Comb Spanner
AC44	1PC 1-3/8" Comb Spanner
AC46	1PC 1-7/16" Comb Spanner
AC48	1PC 1-1/2" Comb Spanner
17674	4PC Circlip Pliers Set 230mm
13668	10PC 1/2" Dr In-Hex Socket Set AF
13669	10PC 1/2" Dr In-Hex Socket Set Metric
11320	20PC 1/2" Dr Impact Socket Set AF
11321	20PC 1/2" Dr Impact Socket Set Metric
10617	9PC Hex Key Set AF
10616	9PC Hex Key Set Metric
PT52	110PC Tap & Die Set
16240	6PC Precision Screwdriver Set
10700	4PC Rolling Head Pry Bar Set
A13395	28PC Hex & Star Bit Set
A13060	30PC Hex Key Set Metric & AF
A7100	7PC Punch & Chisel Set
A7200	8PC Long Pin Punch Set
12601	5PC Screw Extractor Set
12404	1PC Auto Loading Utility Knife
10400	1PC 10m Tape Measure
17255	1PC Gasket Scissors
15102	1PC 450mm Bolt Cutter
15122	1PC 450mm Pipe Wrench
A13030	1PC Adjustable Wrench 250mm
A13032	1PC Adjustable Wrench 375mm
14092	1PC 450g Ball Pein Hammer
14093	1PC 650g Ball Pein Hammer
14094	1PC 900g Ball Pein Hammer
07118	1PC 450mm Podger Bar
40026	1PC 8mm Brake Adjuster
12265	1PC 300mm Hacksaw

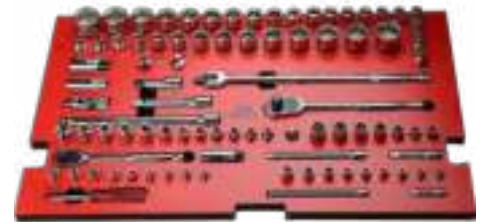





**INFERNO**

**JET**

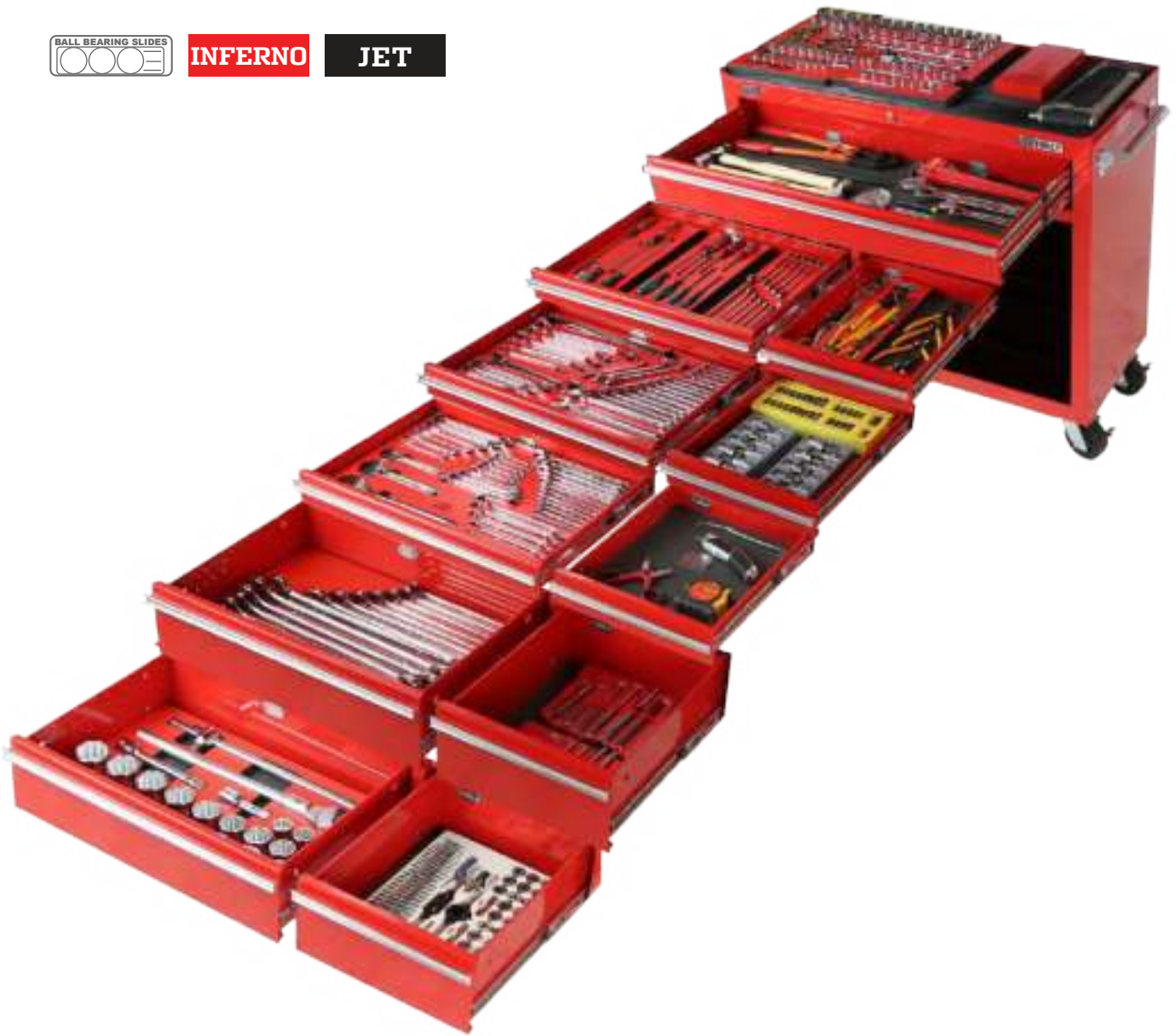

1. Tool Kits & Inserts



# 1. Tool Kits & Inserts

## ATK18D

### 523 Piece Metric & AF Tool Kit in a 11 Drawer Roll Cabinet With 8 HDFI Deep Inserts

Code	Description
A12107B	7 Drawer Tool Box With Ball Bearing Sliders (1051 x 445 x 552)
A12111B	11 Drawer Roll Cabinet With Ball Bearing Sliders (1067 x 480 x 909)
80800D-1	High Density Foam Insert Tray
A13330	45PC 1/4" & 3/8" Dr Socket Set Metric & AF
A13170	43PC 1/2" Dr Socket Set Metric & AF
80800D-2	High Density Foam Insert Tray
16250	1PC Offset Screwdriver
16315	1PC 8.0 x 150mm Screwdriver
16316	1PC 10.0 x 200mm Screwdriver
16344	1PC No.2 x 200mm Screwdriver
16348	1PC No.3 x 150mm Screwdriver
80800D-3	High Density Foam Insert Tray
16310	1PC 3.0 x 75mm Screwdriver
16350	1PC No.2 x 25mm Screwdriver
16312	1PC 4.0 x 100mm Screwdriver
16313	1PC 5.5 x 125mm Screwdriver
16314	1PC 6.5 x 150mm Screwdriver
16321	1PC 6.5 x 25mm Screwdriver
16340	1PC No.0 x 60mm Screwdriver
16341	1PC No.1 x 80mm Screwdriver
16343	1PC No.2 x 100mm Screwdriver
80800D-4	High Density Foam Insert Tray
17380	1PC 250mm Multigrip Pliers
17024	1PC 250mm Locking Pliers
40032	1PC 32 Blade End Feeler Gauge
17371	1PC Diagonal Cutters 180mm
17352	1PC Combination Pliers 200mm
17361	1PC Long Nose Pliers 200mm
80800D-5	High Density Foam Insert Tray
A13028	1PC 150mm Adjustable Wrench
A13029	1PC 200mm Adjustable Wrench
A13031	1PC 300mm Adjustable Wrench
A13145	6PC Ring Spanner Set Metric
A13290	6PC Open End Spanner Set Metric
A13336	12PC Comb Spanner Set Metric
A13520	1PC 10mm XS Comb Spanner
A13521	1PC 11mm XS Comb Spanner
A13522	1PC 12mm XS Comb Spanner
A13523	1PC 13mm XS Comb Spanner
A13524	1PC 14mm XS Comb Spanner
A13542	3PC Flare Nut Spanner Set Metric
80800D-6	High Density Foam Insert Tray
A13334	12PC Comb Spanner Set AF
A13510	1PC 3/8" XS Comb Spanner
A13511	1PC 7/16" XS Comb Spanner
A13512	1PC 1/2" XS Comb Spanner
A13513	1PC 9/16" XS Comb Spanner
A13537	3PC Flare Nut Spanner Set AF
A13140	6PC Ring Spanner Set AF
A13285	6PC Open End Spanner Set AF
80196	High Density Foam Insert Tray
A13362	26PC 3/4" Dr Socket Set Met & AF
80800D-10	High Density Foam Insert Tray
RSK-8i	7PC Gear Ratchet Spanner Set AF
RSK-8	7PC Gear Ratchet Spanner Set Met
Code	Description
ACM22	1PC 22mm Comb Spanner
ACM23	1PC 23mm Comb Spanner
ACM24	1PC 24mm Comb Spanner
ACM25	1PC 25mm Comb Spanner
ACM26	1PC 26mm Comb Spanner
ACM27	1PC 27mm Comb Spanner
ACM30	1PC 30mm Comb Spanner

ACM32	1PC 32mm Comb Spanner
AC32	1PC 1" Comb Spanner
AC34	1PC 1-1/16" Comb Spanner
Code	Description
AC36	1PC 1-1/8" Comb Spanner
AC40	1PC 1-1/4" Comb Spanner
AC42	1PC 1-5/16" Comb Spanner
AC44	1PC 1-3/8" Comb Spanner
AC46	1PC 1-7/16" Comb Spanner
AC48	1PC 1-1/2" Comb Spanner
17674	4PC Circlip Pliers Set 230mm
13668	10PC 1/2" Dr In-Hex Socket Set AF
13669	10PC 1/2" Dr In-Hex Socket Set Metric
11320	20PC 1/2" Dr Impact Socket Set AF
11321	20PC 1/2" Dr Impact Socket Set Metric
10617	9PC Hex Key Set AF
10616	9PC Hex Key Set Metric
PT52	110PC Tap & Die Set
16240	6PC Precision Screwdriver Set
10700	4PC Rolling Head Pry Bar Set
A13395	28PC Hex & Star Bit Set
A13060	30PC Hex Key Set Metric & AF
A7100	7PC Punch & Chisel Set
A7200	8PC Long Pin Punch Set
12601	5PC Screw Extractor Set
12404	1PC Auto Loading Utility Knife
10400	1PC 10m Tape Measure
17255	1PC Gasket Scissors
15102	1PC 450mm Bolt Cutter
15122	1PC 450mm Pipe Wrench
A13030	1PC Adjustable Wrench 250mm
A13032	1PC Adjustable Wrench 375mm
14092	1PC 450g Ball Pein Hammer
14093	1PC 650g Ball Pein Hammer
14094	1PC 900g Ball Pein Hammer
07118	1PC 450mm Podger Bar
40026	1PC 8mm Brake Adjuster
12265	1PC 300mm Hacksaw

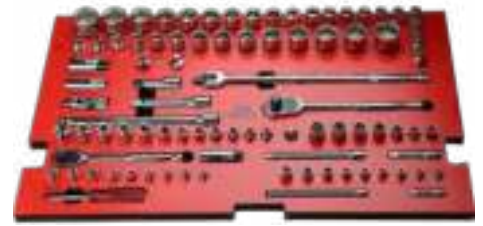





# 1. Tool Kits & Inserts

## ATK42BB

### 694 Piece Metric & AF Tool Kit in a 13 Drawer Roll Cabinet With 27 HDFI Inserts

Code	Description
A22105	13 Drawer Roll Cabinet With Ball Bearing Slides and Auto Retract Drawers (1355 x 472 x 960mm)
80121T	High Density Foam Insert Tray
A13340	39PC Comb Spanner Set Met & AF
80086T	High Density Foam Insert Tray
A13140	6PC Ring Spanner Set AF
A13145	6PC Ring Spanner Set Metric
A13285	6PC Open End Spanner Set AF
A13290	6PC Open End Spanner Set Metric
H50	A.O.K
H50	1PC 1/2" Drive Torque Wrench
80094T	High Density Foam Insert Tray
A13750	7PC Rev Gear Rat Span Set AF
A13600	7PC Rev Gear Rat Span Set Metric
A13502	14PC S.Comb Span Set Met & AF
A13536	6PC Flare Nut Spanner Set AF
A13541	6PC Flare Nut Spanner Set Metric
80410T	High Density Foam Insert Tray
A13167	4PC Long Ring Spanner Set AF
A13160	4PC Long Ring Spanner Set Metric
80002T	High Density Foam Insert Tray
A7250	6PC Cold Chisel Set
A7220	5PC Centre Punch Set
80004T	High Density Foam Insert Tray
A7200	8PC Long Pin Punch Set
80012T	High Density Foam Insert Tray
17018	1PC Locking Pliers 125mm
17024	1PC Locking Pliers 250mm
17026	1PC L/Nose Locking Pliers 230mm
17027	1PC L/Nose Locking Pliers 150mm
80436T	High Density Foam Insert Tray
10355	3PC Power Tool Adaptor Set
80408T	High Density Foam Insert Tray
A13028	1PC Adjustable Wrench 150mm
A13029	1PC Adjustable Wrench 200mm
A13030	1PC Adjustable Wrench 250mm
A13031	1PC Adjustable Wrench 300mm
80015T	High Density Foam Insert Tray
M1150	1PC Vernier Digital 150mm
M3025D	1PC 0-25 Digital Micrometer
50170	1PC 150mm Steel Rule
10395	1PC 5m Tape
40030	1PC 26 Blade Feeler Gauge
80020T	High Density Foam Insert Tray
16245	6PC Precision Screwdriver Set
12601	5PC Screw Extractor Set
17255	1PC Gasket Scissors
80025T	High Density Foam Insert Tray
A13390	54PC Hex & Star Bit Set
80430T	High Density Foam Insert Tray
13410	10PC 1/4" & 3/8" Dr E Socket Set
80406T	High Density Foam Insert Tray
17380	1PC Multigrips 250mm
17387	1PC Heavy Duty Multigrips 400mm
80080T	High Density Foam Insert Tray
A13080	9PC T-Handle Ball Hex Key Set Met
A13082	9PC T-Handle Ball Hex Key Set AF
80414T	High Density Foam Insert Tray
16390	4PC Hook & Pick Set
08308	4PC Magnets & Mirrors Set
10427	1PC Brass Circuit Tester
08572	1PC Dual Type Standard Tyre Gauge
50171	1PC 300mm Rule
80135T	High Density Foam Insert Tray
A13330	45PC 1/4" & 3/8" Dr Socket Set Metric & AF
A13170	43PC 1/2" Dr Socket Set Metric & AF

80420T	High Density Foam Insert Tray
NH15	1PC 1/4" Dr Flex Head Stubby Rat
NH36	1PC 3/8" Dr Flex Head Stubby Rat
NH10	1PC 1/2" Dr Flex Head Stubby Rat
KC407	1PC 1/4" Dr Extension Bar 250mm
KC310	1PC 3/8" Dr Extension Bar 250mm
KC320	1PC 3/8" Dr Extension Bar 500mm
ZDA20	1PC 1/2" Dr Extension Bar 500mm
80402T	High Density Foam Insert Tray
07118	1PC Podger Bar 450mm
08103	3PC Gasket Scraper Set
08319	1PC Scriber
80160T	High Density Foam Insert Tray
17400	1PC Combination Pliers 125mm
17401	1PC Long Nose Pliers 125mm
17402	1PC Diagonal Cutters 115mm
17404	1PC 45° Bent Nose Pliers 125mm
17673	1PC Circlip Pliers Ext. Bent 180mm
17671	1PC Circlip Pliers External 180mm
17672	1PC Circlip Pliers Int. Bent 180mm
17670	1PC Circlip Pliers Internal 180mm
17511	1PC 4 Point Gripping Pliers 200mm
17352	1PC Combination Pliers 200mm
17361	1PC Long Nose Pliers 200mm
17370	1PC Diagonal Cutters 150mm
17385	1PC Multigrip Pliers 250mm
80084T	High Density Foam Insert Tray
16250	1PC Offset Screwdriver
16302	13PC Screwdriver Set
16305	8PC Star Screwdriver Set
16306	8PC Tamperproof Screwdriver Set
80404T	High Density Foam Insert Tray
17250	1PC Tinsnips Right Cut
17251	1PC Tinsnips Left Cut
17252	1PC Tinsnips Straight Cut
80082T	High Density Foam Insert Tray
11320	20PC 1/2" Dr Impact Socket Set AF
11321	20PC 1/2" Dr Impact Socket Set Met
11322	8PC 1/2" Dr Impact In-Hex Socket Set AF
11323	8PC 1/2" Dr Impact In-Hex Socket Set Metric
11325	1PC 1/2" Dr Impact Universal Joint
11328	1PC 1/2" Dr Impact Ext.Bar 75mm
11329	1PC 1/2" Dr Impact Ext.Bar 125mm
11330	1PC 1/2" Dr Impact Ext.Bar 250mm
80400T	High Density Foam Insert Tray
11220	12PC 3/8" & 1/2" Dr Crows Foot Set AF
11221	15PC 3/8" & 1/2" Dr Crows Foot Set Metric
11218	1PC 3/8" Dr Impact Ext Bar 75mm
11219	1PC 3/8" Dr Impact Ext Bar 150mm
11216	1PC 3/8" Dr Impact Universal Joint
11326	1PC Adaptor 1/2" F to 3/8" M
80155T	High Density Foam Insert Tray
A13355	8PC 1/4" Dr Deep Socket Set AF
A13356	8PC 1/4" Dr Deep Socket Set Met
A13315	8PC 3/8" Dr Deep Socket Set AF
A13316	8PC 3/8" Dr Deep Socket Set Met
A13694	10PC 1/2" Dr Deep Socket Set AF
A13695	12PC 1/2" Dr Deep Socket Set Met
13668	10PC 1/2" Dr In-Hex Skt Set AF
13669	10PC 1/2" Dr In-Hex Skt Set Metric
WB309	1PC 3/8" Dr Wobble Bar 250mm
WB34	1PC 1/2" Dr Wobble Bar 250mm
WB36	1PC 1/2" Dr Wobble Bar 500mm
80196T	High Density Foam Insert Tray
A13362	26PC 3/4" Dr Socket Set Met & AF

Code	Description
40026	1PC Brake Adjuster
A13060	30PC Hex Key Set Metric & AF
12009	60PC Tap & Die Set
12265	1PC 300mm Hacksaw
14090	1PC 225g Ball Pein Hammer
14092	1PC 450g Ball Pein Hammer
14095	1PC 1300g Ball Pein Hammer
17694	4PC Circlip Pliers Set







INFERNO

FLAME

JET



1. Tool Kits & Inserts



# 1. Tool Kits & Inserts

## ATK900

**220 Piece Metric & AF Tool Kit in a 6 Drawer Tool Box & a 7 Drawer Roll Cabinet**

Code	Description
A10052	6 Drawer Tool Box With Ball Bearing Slides (660 x 307 x 377mm)
A10056	7 Drawer Roll Cabinet With Ball Bearing Slides (680 x 458 x 995mm)
80702	Vacuum Formed Insert
A13330	45PC 1/4" & 3/8" Dr Socket Set Metric & AF
A13170	43PC 1/2" Dr Socket Set Metric & AF
80704	Vacuum Formed Insert
A7100	7PC Punch & Chisel Set
80706	Vacuum Formed Insert
A13390	54PC Hex & Star Bit Set
80708	Vacuum Formed Insert
17352	1PC Combination Pliers 200mm
17361	1PC Long Nose Pliers 200mm
17371	1PC Diagonal Cutters 150mm
80710	Vacuum Formed Insert
A13328	24PC Comb Spanners Set Met & AF
80712	Vacuum Formed Insert
12404	1PC Trimming Knife
16301	7PC Anti-Slip Screwdriver Set
17380	1PC Multigrips 250mm
17024	1PC Locking Pliers 250mm
14092	1PC Ball Pein Hammer 450g
A13030	1PC 250mm Adjustable Wrench
A13028	1PC 150mm Adjustable Wrench
Code	Description
A13060	30PC Hex Key Set Metric & AF
12262	1PC Hacksaw 300mm

INFERNO

JET





**ATK920**  
**220 Piece Metric & AF Tool Kit**  
**in a 9 Drawer Tool Box**

**INFERNO**

**JET**

Code	Description
A10059	9 Drawer Tool Box With Ball Bearing Slides (660 x 307 x 377mm)
80702	Vacuum Formed Insert
A13330	45PC 1/4" & 3/8" Dr Socket Set Metric & AF
A13170	43PC 1/2" Dr Socket Set Metric & AF
80704	Vacuum Formed Insert
A7100	7PC Punch & Chisel Set
80706	Vacuum Formed Insert
A13390	54PC Hex & Star Bit Set
80708	Vacuum Formed Insert
17352	1PC Combination Pliers 200mm
17361	1PC Long Nose Pliers 200mm
17371	1PC Diagonal Cutters 150mm
80710	Vacuum Formed Insert
A13328	24PC Comb Spanners Set Met & AF
80712	Vacuum Formed Insert
12404	1PC Trimming Knife
16300	7PC Anti-Slip Screwdriver Set
17380	1PC Multigrips 250mm
17024	1PC Locking Pliers 250mm
14092	1PC Ball Pein Hammer 450g
A13030	1PC 250mm Adjustable Wrench
A13028	1PC 150mm Adjustable Wrench
Code	Description
A13060	30PC Hex Key Set Metric & AF
12262	1PC Hacksaw 300mm



# 1. Tool Kits & Inserts

## ATK95BB

### 190 Piece Metric Tool Kit in a 9 Drawer Tool Box

Code	Description
A190059	9 Drawer Tool Box With Ball Bearing Slides (660 x 308 x 435mm)
80000	Vacuum Formed Insert
17380	1PC 250mm Multigrips Pliers
17024	1PC 250mm Locking Pliers
40032	1PC 32 Blade Feeler Gauge
80005	Vacuum Formed Insert
17371	1PC 180mm Diagonal Cutters
17352	1PC 200mm Combination Pliers
17361	1PC 200mm Longnose Pliers
80025	Vacuum Formed Insert
A13390	54PC Hex & Star Bit Set
80095	Vacuum Formed Insert
A13336	12PC Comb Spanner Set Metric
16302	13PC Screwdriver Set
80145	Vacuum Formed Insert
A13356	8PC 1/4" Dr Deep Socket Set Met
A13316	9PC 3/8" Dr Deep Socket Set Met
A13695	12PC 1/2" Dr Deep Socket Set Met
A13173	33PC 1/2" Dr Socket Set Met
NH38	1PC 200mm 3/8" Dr Banjo Ratchet
NH16	1PC 140mm 1/4" Dr Banjo Ratchet
AZDA114	1PC 1/4" Dr Universal Joint
AKC300	1PC 3/8" Dr Universal Joint
A14420	1PC 1/4" Dr 4mm Socket
A14422	1PC 1/4" Dr 5mm Socket
A14424	1PC 1/4" Dr 6mm Socket
A14425	1PC 1/4" Dr 7mm Socket
A14426	1PC 1/4" Dr 8mm Socket
A14427	1PC 1/4" Dr 9mm Socket
A14428	1PC 1/4" Dr 10mm Socket
A14429	1PC 1/4" Dr 11mm Socket
A14430	1PC 1/4" Dr 12mm Socket
A14348	1PC 3/8" Dr 8mm Socket
A14349	1PC 3/8" Dr 9mm Socket
A14350	1PC 3/8" Dr 10mm Socket
A14351	1PC 3/8" Dr 11mm Socket
A14352	1PC 3/8" Dr 12mm Socket
A14353	1PC 3/8" Dr 13mm Socket
A14354	1PC 3/8" Dr 14mm Socket
A14355	1PC 3/8" Dr 15mm Socket
A14356	1PC 3/8" Dr 16mm Socket
A14357	1PC 3/8" Dr 17mm Socket
A14358	1PC 3/8" Dr 18mm Socket
A14359	1PC 3/8" Dr 19mm Socket
A14721	1PC 1/4" Dr Spinner Handle
KC1438	1PC 1/4" F to 3/8" M Dr Adaptor
AKC403	1PC 50mm 1/4" Dr Extension Bar
AKC406	1PC 150mm 1/4" Dr Extension Bar
KC323	1PC 75mm 3/8" Dr Extension Bar
KC326	1PC 150mm 3/8" Dr Extension Bar
Code	Description
14092	1PC Ball Pien Hammer 450g
12265	1PC 300mm Hacksaw
A13030	1PC Adjustable Wrench 250mm
A13028	1PC Adjustable Wrench 150mm
A7200	8PC Long Pin Punch Set
10616	9PC Hex Key Set Metric





**ATK960**  
**244 Piece Metric & AF Tool Kit**  
**in a 9 Drawer Tool Box &**  
**a 7 Drawer Roll Cabinet**

Code	Description
A10059R	9 Drawer Tool Box With Ball Bearing Slides (660 x 307 x 435mm)
A10056R	7 Drawer Roll Cabinet With Ball Bearing Slides (680 x 458 x 802mm)
80702	Vacuum Formed Insert
A13330	45PC 1/4" & 3/8" Dr Socket Set Metric & AF
A13170	43PC 1/2" Dr Socket Set Metric & AF
80704	Vacuum Formed Insert
A7100	7PC Punch & Chisel Set
80706	Vacuum Formed Insert
A13390	54PC Hex & Star Bit Set
80708	Vacuum Formed Insert
17352	1PC Combination Pliers 200mm
17361	1PC Long Nose Pliers 200mm
17371	1PC Diagonal Cutters 150mm
80710	Vacuum Formed Insert
A13328	24PC Comb Spanners Set Met & AF
80712	Vacuum Formed Insert
12404	1PC Trimming Knife
16300	7PC Anti-Slip Screwdriver Set
17380	1PC Multigrips 250mm
17024	1PC Locking Pliers 250mm
14092	1PC Ball Pein Hammer 450g
A13030	1PC 250mm Adjustable Wrench
A13028	1PC 150mm Adjustable Wrench
Code	Description
A13060	30PC Hex Key Set Metric & AF
12262	1PC Hacksaw 300mm
11301	10PC 1/2" Socket Set, Impact Met
11305	10PC 1/2" Socket Set, Impact AF
12420	10pkt Blades for 12404
17674	4PC Circlip Plier Set



# 1. Tool Kits & Inserts

## ATK703U

### 262 Piece Metric & AF Tool Kit in a 3 Drawer Ute Box With 3 HDFI Inserts

Code	Description
UB3	3 Drawer Ute Box (735 x 465 x 586mm)
80135T	High Density Foam Insert Tray
A13330	45PC 1/4" & 3/8" Dr Skt Set Met & AF
A13170	43PC 1/2" Dr Socket Set Met & AF
80100T	High Density Foam Insert Tray
16250	1PC Offset Screwdriver
16316	1PC 10x200mm Screwdriver
16315	1PC 8.0x150mm Screwdriver
16348	1PC No.3x150mm Screwdriver
16344	1PC No.2x200mm Screwdriver
A13145	6PC Ring Spanner Set Metric
A13290	6PC Open End Spanner Set Metric
A13336	12PC Comb Spanner Set Metric
A13520	1PC 10mm XS Comb Spanner
A13521	1PC 11mm XS Comb Spanner
A13522	1PC 12mm XS Comb Spanner
A13523	1PC 13mm XS Comb Spanner
A13524	1PC 14mm XS Comb Spanner
80105T	High Density Foam Insert Tray
16240	6PC Precision Screwdriver Set
12601	5PC Screw Extractor Set
A13140	6PC Ring Spanner Set AF
A13285	6PC Open End Spanner Set AF
A13334	12PC Combination Spanner Set AF
A13510	1PC 3/8" XS Comb Spanner
A13511	1PC 7/16" XS Comb Spanner
A13512	1PC 1/2" XS Comb Spanner
A13513	1PC 9/16" XS Comb Spanner
Code	Description
16310	1PC 3.0x75mm Screwdriver
16312	1PC 4.0x100mm Screwdriver
16313	1PC 5.5x125mm Screwdriver
16314	1PC 6.5x150mm Screwdriver
16321	1PC 6.5x25mm Stubby Screwdriver
16340	1PC No.0x60mm Screwdriver
16341	1PC No.1x80mm Screwdriver
16343	1PC No.2x100mm Screwdriver
16350	1PC No.2x25mm Stubby Screwdriver
Code	Description
A13060	30PC Hex Key Set Metric & AF
A7200	8PC Long Pin Punch Set
A7100	7PC Punch and Chisel Set
A13542	3PC Flare Nut Spanner Set Metric
A13537	3PC Flare Nut Spanner Set AF
A13395	28PC Hex & Star Bit Set
14092	1PC Ball Pein Hammer 450g
40026	1PC Break Adjuster
12265	1PC 300mm Hacksaw
A13028	1PC Adjustable Wrench 150mm
A13029	1PC Adjustable Wrench 200mm
A13031	1PC Adjustable Wrench 300mm
07118	1PC Podger Bar 450mm
17371	1PC 180mm Diagonal Cutters
17352	1PC 200mm Combination Pliers
17361	1PC 200mm Long Nose Pliers
17380	1PC 250mm Multigrip Pliers
17024	1PC 250mm Locking Pliers
40032	1PC 32 Blade End Feeler Gauge





**155TK**  
**152 Piece Metric & AF Tool Kit**  
**in a 3 Drawer Ute Box**

Code	Description
UB3	3 Drawer Ute Box (735 x 465 x 586mm)
Code	Description
SD13	13PC Screwdriver Set
A7260	6PC Punch & Chisel Set
15610	1PC Combination Pliers 200mm
15612	1PC Long Nose Pliers 200mm
15614	1PC Diagonal Cutting Pliers 175mm
15616	1PC Multigrips 250mm
12265	1PC Hacksaw 300mm
A13395	28PC Hex & Torx Bits Set
15022	1PC Club Hammer 1,800g
15012	1PC Ball Pein Hammer 900g
15625	1PC Locking Pliers 250mm
15580	1PC Adjustable Wrench 250mm
15584	1PC Adjustable Wrench 375mm
10400	1PC 10m Tape Measure
15860	24PC Comb Spanner Set Met & AF
07118	1PC Pry Bar 450mm
10120	41PC 1/2" Dr Socket Set Met & AF
15134	1PC Steel Pipe Wrench 600mm
17602	1PC Fencing Pliers 330mm
19344	27PC 3/4" Dr Socket Set Met & AF



# 1. Tool Kits & Inserts

## ATK50

### 248 Piece Metric & AF Tool Kit in a Lockable Wallcabinet with 1 HDFI Insert

Code	Description
TCW1	Wallcabinet With a Ball Bearing Slide Drawer (65.5 x 18.6 x 90.5mm)
80610T	High Density Foam Insert Tray
A13330	45PC 1/4" Dr & 3/8" Dr Socket Set Metric & AF
A13170	43PC 1/2" Dr Socket Set Met & AF
Code	Description
A13334	12PC Combination Spanner Set AF

A13336	12PC Combination Spanner Set Met
A13285	6PC Open End Spanner Set AF
A13290	6PC Open End Spanner Set Metric
A13140	6PC Ring Spanner Set AF
A13145	6PC Ring Spanner Set Metric
A13028	1PC Adjustable Wrench 150mm
A13029	1PC Adjustable Wrench 200mm
A13031	1PC Adjustable Wrench 300mm
A13395	28PC Hex & Star Bits Set
A13060	30PC Hex Key Set Metric & AF
A13520	1PC XS Combination Spanner 10mm
A13521	1PC XS Combination Spanner 12mm
A13522	1PC XS Combination Spanner 13mm
A13523	1PC XS Combination Spanner 14mm
A13524	1PC XS Combination Spanner 15mm
A13510	1PC XS Combination Spanner 3/8"

A13511	1PC XS Combination Spanner 7/16"
A13512	1PC XS Combination Spanner 1/2"
A13513	1PC XS Combination Spanner 9/16"
16250	1PC Offset Screwdriver
16240	6PC Precision Screwdriver Set
17352	1PC Combination Pliers 200mm
17361	1PC Long Nose Pliers 200mm
17371	1PC Diagonal Cutters 180mm
17024	1PC Locking Pliers 250mm
17380	1PC Multigrips 250mm
A7100	7PC Punch & Chisel Set
07118	1PC Podger Bar
12601	5PC Screw Extractor Set
14092	1PC Ball Pein Hammer 450g
40032	1PC Feeler Gauge
40024	1PC Brake Adjuster
12265	1PC Hacksaw



## ATK115

### 115 Piece Metric & AF Tool Kit in a 5 Tray Cantilever Box With 1 HDFI Insert

Code	Description
A12182	5 Tray Cantilever Toolbox (466 x 210 x 232mm)
80500T	High Density Foam Insert Tray
A13330	45PC Socket Set Metric & AF

Code	Description
16300	7PC Screwdriver Set
17024	1PC 250mm Locking Pliers
17352	1PC 200mm Combination Pliers
17361	1PC 200mm Long Nose Pliers
17371	1PC 180mm Diagonal Cutters
17380	1PC 250mm Multigrips
A13030	1PC 250mm Adjustable Wrench
A13328	24PC Combination Spanner Set Metric & AF
A13060	30PC Hex Key Set Metric & AF
14092	1PC 450g Ball Pein Hammer
12404	1PC Knife
10400	1PC 10m Tape Measure





**106TK**  
**153 Piece Metric & AF Tool Kit**  
**in a 3 Drawer Tool Box with 1**  
**HDFI Insert**

Code	Description
A10052R	3 Drawer Tool Box With Ball Bearing Slides (660 x 308 x 330mm)
90000T	High Density Foam Insert Tray
10100	39PC 1/4" & 3/8" Dr Socket Set Metric & AF
10120	41PC 1/2" Dr Socket Set Met & AF
AZDA315	1PC 1/2" Dr Breaker Bar 375mm
10160	1PC 1/4" Dr Banjo Ratchet
AKC1238	1PC Adaptor 1/2" F to 3/8" M
AKC403	1PC Ext Bar Hex Head 50mm
AKC406	1PC Ext Bar Hex Head 150mm
Code	Description
15610	1PC Combination Pliers 200mm
15612	1PC Long Nose Pliers 200mm
15614	1PC Diagonal Cutting Pliers 175mm
15616	1PC Multigrips 250mm
15860	24PC Comb Spanner Set Met & AF
14092	1PC Ball Pein Hammer 450g
10600	25PC Hex Key Set Metric & AF
SD13	13PC Screwdriver Set
15625	1PC Locking Pliers 250mm



# 1. Tool Kits & Inserts

## 103TK

### 196 Piece Metric & AF Tool Kit in a 6 Drawer Tool Box with 1 HDFI Insert

Code	Description
A10052R	6 Drawer Tool Box With Ball Bearing Slides (660 x 308 x 380mm)
90000T	High Density Foam Insert Tray
10100	39PC 1/4" & 3/8" Dr Socket Set Metric & AF
10120	41PC 1/2" Dr Socket Set Met & AF
AZDA315	1PC 1/2" Dr Breaker Bar 375mm
10160	1PC 1/4" Dr Banjo Ratchet
AKC1238	1PC Adaptor 1/2" F to 3/8" M
AKC403	1PC Ext Bar 50mm
AKC406	1PC Ext Bar 150mm
Code	Description
10660	7PC Tamperproof Bit Set
12135	1PC Folding Utility Knife
12420	10PC Spare Knife Blades
10395	1PC 5m Tape Measure
10027	3PC Offset Screwdriver Set
10427	1PC Circuit Tester
10419	8PC Hook & Pick Set
137408	1PC Aluminium Torch
15860	24PC Comb Spanner Set Met & AF
SD13	13PC Screwdriver Set
15610	1PC Combination Pliers 200mm
15612	1PC Long Nose Pliers 200mm
15614	1PC Diagonal Cutting Pliers 175mm
15616	1PC Multigrips 250mm
15625	1PC Locking Pliers 250mm
19013	7PC Punch & Chisel Set
14092	1PC Ball Pein Hammer 450g
10600	25PC Hex Key Set Metric & AF
10576	1PC Adjustable Wrench 150mm
10580	1PC Adjustable Wrench 250mm
12262	1PC Hacksaw
SG1072	1PC Air Duster 100mm





**105TK**  
**278 Piece Metric & AF Tool Kit**  
**in a 6 Drawer Tool Box 2 Drawer**  
**Add-on and a 7 Drawer Roll**  
**Away with 1 Insert**

Code	Description
A10052R	6 Drawer Tool Box With Ball Bearing Slides (660 x 308 x 380mm)
A10053R	2 Drawer Add-on With Ball Bearing Slides (660 x 310 x 256mm)
A10056	7 Drawer Roll Cabinet With Ball Bearing Slides (670 x 460 x 655mm)
90000T	Vacuum Formed Insert Tray
10100	39PC 1/4" & 3/8" Dr Socket Set Metric & AF
10120	41PC 1/2" Dr Socket Set Met & AF
Code	Description
12404	1PC Safety Retractable Knife
12420	10PC Spare Knife Blades
15860	24PC Comb Spanner Set Met & AF
10600	25PC Hex Key Set Metric & AF
10576	1PC Adjustable Wrench 150mm
10580	1PC Adjustable Wrench 250mm
A7100	7PC Punch & Chisel Set
12262	1PC Hacksaw 300mm
14092	1PC Ball Pein Hammer 450g
15610	1PC Combination Pliers 200mm
15612	1PC Long Nose Pliers 200mm
15614	1PC Diagonal Cutting Pliers 175mm
15616	1PC Multigrips 250mm
15625	1PC Locking Pliers 250mm
19009	6PC Precision Screwdriver Set
40032	1PC Feeler Gauge
10398	1PC 8m Tape Measure
A13390	54PC Hex, Star & Spline Bits Set
10419	8PC Hook & Pick Set
SD13	13PC Screwdriver Set
WDS25M	25PC Drill Bit Set Metric





# 1. Tool Kits & Inserts

## 101TK

### 257 Piece Metric & AF Tool Kit in a 9 Drawer Tool Box with 1 HDFI Insert

Code	Description
A10059R	9 Drawer Tool Box With Ball Bearing Slides (660 x 308 x 435mm)
90000T	Vacuum Foamed Insert Tray
10100	39PC 1/4" & 3/8" Dr Socket Set Metric & AF
10120	41PC 1/2" Dr Socket Set Met & AF
SD13	13PC Anti-Slip Screwdriver Set
19009	6PC Precision Screwdriver Set
10027	3PC Offset Screwdriver Set
15860	24PC Comb Spanner Set Met & AF
10600	25PC Hex Key Set Metric & AF
10640	40PC Hex, Star & Spline Bits Set
10419	8PC Hook & Pick Set
10427	1PC Brass Circuit Tester
10440	5PC Screw Extractor Set
10576	1PC Adjustable Wrench 150mm
10580	1PC Adjustable Wrench 250mm
15610	1PC Combination Pliers 200mm
15612	1PC Long Nose Pliers 200mm
15614	1PC Diagonal Cutting Pliers 175mm
15616	1PC Multigrips 250mm
15625	1PC Locking Pliers 250mm
14092	1PC Ball Pein Hammer 450g
137408	1PC Torch
10395	1PC 5m Tape Measure
12135	1PC Folding Utility Knife
12420	10PC Spare Blades To Suit 12135
12265	1PC Hacksaw
19013	7PC Punch & Chisel Set
40030	1PC Feeler Gauge
WDS25M	25PC Drill Bit Set Metric





<b>110TK</b>	
<b>135 Piece Metric &amp; AF Tool Kit in a 5 Tray Cantilever</b>	
Code	Description
A12182	5 Tray Cantilever Tool Box (466 x 210 x 232mm)
90500T	High Density Foam Insert Tray
10100	39PC 1/4" & 3/8" Dr Socket Set Metric & AF
Code	Description
10395	1PC 5m Tape Measure
10428	1PC 6, 12 & 24v Circuit Tester
12135	1PC Folding Utility Knife
136573	1PC Head Torch 7 LED
SD13	13PC Anti-Slip Screwdriver Set
15860	24PC Combination Spanner Set Metric & AF
10290	14PC Impact Driver Kit
10578	1PC Adjustable Wrench 200mm
10600	25PC Hex Key Set Metric & AF
12416	10PC Spare Knife Blades for 12135
PR13006	2PC Plier Set
15625	1PC Locking Pliers 250mm
15616	1PC Multigrips 250mm
PR13004	3PC Plier Set
15614	1PC Diagonal Cutting Pliers 175mm
15612	1PC Long Nose Pliers 200mm
15610	1PC Combination Pliers 200mm



# 1. Tool Kits & Inserts



80800D-2

## 5PC SCREWDRIVERS HDFI TRAY

80800D-2

Size	164 x 400 x 22mm
Code	Description
80800D-2	1PC High Density Foam Insert Tray
16250	1PC Offset Screwdriver Blade 5.5, Phillips No.2
16315	1PC 8.0 x 150mm Anti-slip Screwdriver
16316	1PC 10.0 x 200mm Anti-slip Screwdriver
16344	1PC No.2 x 200mm Anti-slip Screwdriver
16348	1PC No.3 x 150mm Anti-slip Screwdriver

Suitable for deep drawer tool boxes.



80800D-3

## 9PC SCREWDRIVERS HDFI TRAY

80800D-3

Size	164 x 400 x 22mm
Code	Description
80800D-3T	1PC High Density Foam Insert Tray
16310	1PC 3.0 x 75mm Anti-Slip Screwdriver
16312	1PC 4.0 x 100mm Anti-Slip Screwdriver
16313	1PC 5.5 x 125mm Anti-Slip Screwdriver
16314	1PC 6.5 x 150mm Anti-Slip Screwdriver
16321	1PC 6.5 x 25mm Stubby Anti-Slip Screwdriver
16340	1PC No.0 x 60mm Anti-Slip Screwdriver
16341	1PC No.1 x 80mm Anti-Slip Screwdriver
16343	1PC No.2 x 100mm Anti-Slip Screwdriver
16350	1PC No.2 x 25mm Stubby Anti-Slip Screwdriver

Suitable for deep drawer tool boxes.



80800D-4

## 6PC PLIERS, MULTIGRIP, FEELER GAUGE HDFI TRAY

80800D-4

Size	164 x 400 x 22mm
Code	Description
80800D-4T	1PC High Density Foam Insert Tray
17380	1PC Multigrrips 250mm Grooved Slip Joint
17024	1PC Locking Pliers 250mm
40032	1PC 32 Blade End Feeler Gauge 100mm Long
17371	1PC Diagonal Cutters 180mm Light Insulation
17352	1PC Combination Pliers 200mm Light Insulation
17361	1PC Long Nose Pliers 200mm Light Insulation

Suitable for deep drawer tool boxes.



80800D-10

## 14PC GEAR RATCHET SPANNERS HDFI TRAY

80800D-10

Size	164 x 400 x 22mm
Code	Description
80800D-10T	1PC High Density Foam Insert Tray
RSK-8	7PC Gear Ratchet Spanner Set: 8 - 19mm
RSK-8i	7PC Gear Ratchet Spanner Set: 5/16 - 3/4"

Suitable for deep drawer tool boxes.



# ENTIRE DEEP DRAWER INSERT SERIES, PRODUCT CODE 80800D

Includes - 80800D-1, 80800D-2, 80800D-3, 80800D-4, 80800D-5, 80800D-6

## 88PC SOCKETS HDFI TRAY

80800D-1

Size	668 x 413 x 22mm
<b>Code</b>	<b>Description</b>
80800D-1T	1PC High Density Foam Insert Tray
A13330	45PC 1/4" & 3/8" Drive Socket Set Metric & AF: Metric: 4 - 12mm, 1/4" Drive: AF: 3/16 - 1/2", 1 Spinner Handle & 2 Extensions 50 & 150mm. 3/8" Drive: Metric: 8 to 19mm, AF: 3/8 to 3/4", 1 Banjo Ratchet, 2 Extensions 75 & 150mm, 1 Adaptor 3/8" F to 1/4" M & 1 Spark Plug Socket 5/8"
A13170	43PC 1/2" Drive Socket Set Metric & AF: Metric: 8 - 32mm, AF: 3/8 - 1-1/4", 1 Banjo Ratchet, 1 Flex Head Bar 380mm, 3 Extensions 75, 125 & 250mm, 1 Universal Joint, 1 Adaptor 1/2 F to 3/8" M & 2 Spark Plug Sockets 5/8 & 13/16"



80800D-1  
AKA  
80135B

## 35PC METRIC SPANNERS/ADJUSTABLE WRENCHES HDFI TRAY

80800D-5

Size	560 x 400 x 22mm
<b>Code</b>	<b>Description</b>
80800D-5T	1PC High Density Foam Insert Tray
A13028	1PC Adjustable Wrench 150mm
A13029	1PC Adjustable Wrench 200mm
A13031	1PC Adjustable Wrench 300mm
A13145	6PC Ring Spanner Set Metric: 8 x 9 - 18 x 19mm
A13290	6PC Open End Spanner Set Metric: 8 x 9 - 18 x 19mm
A13336	12PC Combination Spanner Set Metric: 7 - 21mm
A13520	1PC 10mm Combination Spanner Extra Short
A13521	1PC 11mm Combination Spanner Extra Short
A13522	1PC 12mm Combination Spanner Extra Short
A13523	1PC 13mm Combination Spanner Extra Short
A13524	1PC 14mm Combination Spanner Extra Short
A13542	3PC Flare Nut Spanner Set Metric: 10 x 12, 13 x 14, 15 x 17mm



80800D-5

Suitable for deep drawer tool boxes and roll cabinet

## 31PC AF SPANNERS HDFI TRAY

80800D-6

Size	560 x 400 x 22mm
<b>Code</b>	<b>Description</b>
80800D-6T	1PC High Density Foam Insert Tray
A13334	12PC Combination Spanner Set AF: 1/4 - 15/16"
A13510	1PC 3/8" Combination Spanner Extra Short
A13511	1PC 7/16" Combination Spanner Extra Short
A13512	1PC 1/2" Combination Spanner Extra Short
A13513	1PC 9/16" Combination Spanner Extra Short
A13537	3PC Flare Nut Spanner Set AF: 3/8 x 7/16 - 5/8 x 11/16"
A13285	6PC Open End Spanner Set AF: 1/4 x 5/16 - 15/16 x 1"
A13140	6PC Ring Spanner Set AF: 3/8 x 7/16 - 15/16 x 1"



80800D-6

Suitable for deep drawer tool boxes and roll cabinets.

# 1. Tool Kits & Inserts



80000

## 3PC PLIERS, MULTIGRIP, FEELER GAUGE HDFI TRAY

80000

Size	160 x 270 x 22mm
<b>Code</b>	<b>Description</b>
80000T	1PC High Density Foam Insert Tray
17380	1PC Multigrips 250mm Grooved Slip Joint
17024	1PC Locking Pliers 250mm
40032	1PC 32 Blade End Feeler Gauge 100mm Long



80005

## 3PC PLIERS HDFI TRAY

80005

Size	160 x 270 x 22mm
<b>Code</b>	<b>Description</b>
80005T	1PC High Density Foam Insert Tray
17371	1PC Diagonal Cutters 180mm Light Insulation
17352	1PC Combination Pliers 200mm Light Insulation
17361	1PC Long Nose Pliers 200mm Light Insulation



80010

## 9PC SCREWDRIVERS HDFI TRAY

80010

Size	160 x 270 x 22mm
<b>Code</b>	<b>Description</b>
80010T	1PC High Density Foam Insert Tray
16310	1PC 3.0 x 75mm Anti-Slip Screwdriver
16312	1PC 4.0 x 100mm Anti-Slip Screwdriver
16313	1PC 5.5 x 125mm Anti-Slip Screwdriver
16314	1PC 6.5 x 150mm Anti-Slip Screwdriver
16321	1PC 6.5 x 25mm Stubby Anti-Slip Screwdriver
16340	1PC No.0 x 60mm Anti-Slip Phillips Screwdriver
16341	1PC No.1 x 80mm Anti-Slip Screwdriver
16343	1PC No.2 x 100mm Anti-Slip Screwdriver
16350	1PC No.2 x 25mm Stubby Anti-Slip Screwdriver



# ENTIRE STANDARD DRAWER INSERT SERIES, PRODUCT CODE 80800

Includes - 80000, 80005, 80010, 80100, 80105, 80135

## 11PC PUNCH & CHISEL HDFI TRAY

80002

Size	160 x 270 x 22mm
<b>Code</b>	<b>Description</b>
80002T	1PC High Density Foam Insert Tray
A7250	6PC Cold Chisel Set: 10 - 25mm
A7220	5PC Centre Punch Set: No.2 - No.5



80002

## 8PC PUNCH HDFI TRAY

80004

Size	160 x 270 x 22mm
<b>Code</b>	<b>Description</b>
80004T	1PC High Density Foam Insert Tray
A7200	8PC Long Pin Punch Set: 2.5, 3, 4, 5, 6.5 & 10mm



80004

## 13PC MIXED HDFI TRAY

80020

Size	160 x 270 x 22mm
<b>Code</b>	<b>Description</b>
80020T	1PC High Density Foam Insert Tray
16245	6PC Precision Screwdriver Set: 3 Blade: 2.0 x 50, 2.4 x 50 & 3.0 x 50mm, 3 Phillips: Ph00 x 50, Ph0 x 50 & Ph1 x 50mm
12601	5PC Screw Extractor Set Spiral Flute: No.1,2,3,4 & 5
17255	1PC Gasket Scissors



80020

## 54PC HEX & STAR BIT HDFI TRAY

80025

Size	160 x 270 x 22mm
<b>Code</b>	<b>Description</b>
80025T	1PC High Density Foam Insert Tray
A13390	54PC Hex & Star Bit Set: 9 AF Hex Bits 30mm Long, 8 Metric Hex Bits 30mm Long, 2 AF Hex Bits 75mm Long, 3 Metric Hex Bits 75mm Long, 9 Star Bits 30mm Long, 3 Star Bits 75mm Long, 11 Tamperproof Bits, 5 Spline Bits 30mm Long, 2 Spline Bits 75mm Long & 2 Bit Adaptors



80025

# 1. Tool Kits & Inserts



80028

## HOLLOW PUNCH SET HDFI TRAY

80028

Size	160 x 270 x 22mm
Code	Description
80028T	1PC High Density Foam Insert Tray
08050	12PC Hollow Punch Set AF: 1/8, 5/32, 3/16, 7/32, 1/4, 5/16, 3/8, 7/16, 1/2, 9/16, 5/8 & 3/4"



80070

## 30PC HEX KEY SET HDFI TRAY

80070

Size	160 x 270 x 22mm
Code	Description
80070T	1PC High Density Foam Insert Tray
A13060	30PC Hex Key Set Metric & AF: AF Sizes: 1/16 to 3/8" Metric Sizes: 0.7 to 10mm



80434

## MINI CIRCLIP PLIERS HDFI TRAY

80434

Size	160 x 270 x 22mm
Code	Description
80434T	1PC High Density Foam Insert Tray
17150	4PC Mini Circlip Pliers Set

## 88PC SOCKET HDFI TRAY

80135

Size	564 X 270 X 22mm
Code	Description
80135T	1PC High Density Foam Insert Tray
A13330	45PC 1/4" & 3/8" Drive Socket Set Metric & AF: 1/4" Drive: Metric: 4 - 12mm, AF: 3/16 - 1/2", 1 Spinner Handle & 2 Extensions 50 & 150mm. 3/8" Drive: Metric: 8 - 19mm, AF : 3/8 - 3/4", 1 Banjo Ratchet, 2 Extensions 75 & 150mm, 1 Adaptor 3/8F to 1/4" M & 1 Spark Plug Socket 5/8"
A13170	43PC 1/2" Drive Socket Set Metric & AF: Metric: 8 - 32mm, AF : 3/8 - 1-1/4", 1 Banjo Ratchet, 1 Flex Head Bar 380mm, 3 Extensions 75, 125 & 250mm, 1 Universal Joint, 1 Adaptor 1/2F to 3/8" M & 2 Spark Plug Sockets 5/8 & 13/16"



80135



**88PC SOCKET HDFI TRAY**

80135A

Size	564 X 270 X 22mm
<b>Code</b>	<b>Description</b>
80135AT	1PC High Density Foam Insert Tray
A13330	45PC 1/4" & 3/8" Drive Socket Set Metric & AF: Metric: 4 - 12mm, 1/4" Drive: AF: 3/16 - 1/2", 1 Spinner Handle & 2 Extensions 50 & 150mm. 3/8" Drive: Metric: 8 to 19mm, AF: 3/8 to 3/4", 1 Banjo Ratchet, 2 Extensions 75 & 150mm, 1 Adaptor 3/8" F to 1/4" M & 1 Spark Plug Socket 5/8"
A13170	43PC 1/2" Drive Socket Set Metric & AF: Metric: 8 - 32mm, AF : 3/8 - 1-1/4", 1 Banjo Ratchet, 1 Flex Head Bar 380mm, 3 Extensions 75, 125 & 250mm, 1 Universal Joint, 1 Adaptor 1/2F to 3/8" M & 2 Spark Plug Sockets 5/8 & 13/16"



80135A

**39PC COMBINATION SPANNER HDFI TRAY**

80121

Size	560 X 400 X 22mm
<b>Code</b>	<b>Description</b>
80121T	1PC High Density Foam Insert Tray
A13340	39PC Combination Spanner Set Metric & AF: Metric: 7 - 32mm, AF: 1/4 - 1-1/4"



80121

**40PC SPANNERS HDFI TRAY**

80094

Size	564 X 270 X 22mm
<b>Code</b>	<b>Description</b>
80094T	1PC High Density Foam Insert Tray
A13600	7PC Reverse Gear Ratchet Spanner Set Metric: 8 - 19mm
A13750	7PC Reverse Gear Ratchet Spanner Set AF: 5/16 - 3/4"
A13502	14PC Short Combination Spanner Set Metric & AF: Metric: 10 - 19mm, AF: 3/8 - 3/4"
A13541	6PC Flare Nut Spanner Set Metric: 6 x 8 - 22 x 24mm
A13536	6PC Flare Nut Spanner Set AF: 1/4 x 5/16 - 7/8 x 1"



80094

**24PC COMBINATION SPANNERS HDFI TRAY**

80108

Size	564 X 270 X 22mm
<b>Code</b>	<b>Description</b>
80108T	1PC High Density Foam Insert Tray
A13328	24PC Combination Spanner Set Metric & AF: Metric: 7 - 21mm AF: 1/4 - 15/16"



80108

# 1. Tool Kits & Inserts



80105

## 39PC SCREWDRIVER & SPANNER HDFI TRAY 80105

Size	564 X 270 X 22mm
Code	Description
80105T	1PC High Density Foam Insert Tray
16240	6PC Precision Screwdriver Set, Double Ended Screwdrivers: Blade: 2 - 4mm, Phillips: No.00 - No.1, Star: T6 - T20
12601	5PC Screw Extractor Set Spiral Flute : No. 1, 2, 3, 4 & 5
A13140	6PC Ring Spanner Set AF: 3/8 x 7/16 - 15/16 x 1"
A13285	6PC Open End Spanner Set AF: 1/4 x 5/16 - 15/16 x 1"
A13334	12PC Combination Spanner Set AF: 1/4 - 15/16"
A13510	1PC 3/8" Combination Spanner Extra Short
A13511	1PC 7/16" Combination Spanner Extra Short
A13512	1PC 1/2" Combination Spanner Extra Short
A13513	1PC 9/16" Combination Spanner Extra Short



80086

## 24PC RING & OPEN END SPANNER HDFI TRAY 80086

Size	564 X 270 X 22mm
Code	Description
80086T	1PC High Density Foam Insert Tray
A13140	6PC Ring Spanner Set AF: 3/8 x 7/16 - 15/16 x 1"
A13145	6PC Ring Spanner Set Metric: 8 x 9 - 18 x 19mm
A13285	6PC Open End Spanner Set AF: 1/4 x 5/16 - 15/16 x 1"
A13290	6PC Open End Spanner Set Metric: 8 x 9 - 18 x 19mm



80100

## 34PC SCREWDRIVER & SPANNER HDFI TRAY 80100

Size	564 X 270 X 22mm
Code	Description
80100T	1PC High Density Foam Insert Tray
16250	1PC Offset Screwdriver Blade 5.5, Phillips No.2
16316	1PC 10 x 200mm Anti-slip Screwdriver
16315	1PC 8.0 x 150mm Anti-slip Screwdriver
16348	1PC No.3 x 150mm Anti-slip Screwdriver
16344	1PC No.2 x 200mm Anti-slip Screwdriver
A13145	6PC Ring Spanner Set Metric: 8 x 9 - 18 x 19mm
A13290	6PC Open End Spanner Set Metric: 8 x 9 - 18 x 19mm
A13336	12PC Combination Spanner Set Metric: 7 - 21mm
A13520	1PC 10mm Combination Spanner Extra Short
A13521	1PC 11mm Combination Spanner Extra Short
A13522	1PC 12mm Combination Spanner Extra Short
A13523	1PC 13mm Combination Spanner Extra Short
A13524	1PC 14mm Combination Spanner Extra Short



80084

## 31PC SCREWDRIVER HDFI TRAY

80084

Size	564 X 270 X 22mm
Code	Description
80084T	1PC High Density Foam Insert Tray
16250	1PC Offset Screwdriver: Blade: 5.5mm, Phillips: No. 2
16302	13PC Anti-Slip Screwdriver Set: 7 Blade: 3 x 75, 4 x 100, 5.5 x 125, 6.5 x 150, 8 x 150, 10 x 200 & 6.5 x 25mm Stubby, 6 Phillips: No.0 x 60, No.1 x 80, No.2 x 100, No.2 x 200, No.3 x 150 & No.2 x 25mm Stubby
16305	8PC Anti-Slip Star Screwdriver Set: T8 x 60, T10 x 80, T15 x 80, T20 x 100, T25 x 100, T27 x 115, T30 x 115 & T40 x 130mm
16306	8PC Anti-Slip Tamperproof Screwdriver Set: TH8 x 60, TH10 x 80, TH15 x 80, TH20 x 100, TH25 x 100, TH27 x 115, TH30 x 115 & TH40 x 130mm



**18PC T HANDLE HEX KEY HDFI TRAY**

80080

Size	564 X 270 X 22mm
<b>Code</b>	<b>Description</b>
80080T	1PC High Density Foam Insert Tray
A13080	9PC T Handle Ball Hex Key Set Metric: 2 - 12mm
A13082	9PC T Handle Ball Point Hex Key Set AF: 5/64 - 1/2"



80080

**13PC PLIER HDFI TRAY**

80160

Size	564 X 270 X 22mm
<b>Code</b>	<b>Description</b>
80160T	1PC High Density Foam Insert Tray
17400	1PC Mini Combination Pliers 125mm
17401	1PC Mini Long Nose Pliers 125mm
17402	1PC Mini Diagonal Cutters 115mm
17404	1PC Mini 45° Bent Nose Pliers 125mm
17673	1PC Circlip Pliers External Bent 180mm
17671	1PC Circlip Pliers External Straight 180mm
17672	1PC Circlip Pliers Internal Bent 180mm
17670	1PC Circlip Pliers Internal Straight 180mm
17511	1PC Multi-Purpose 4 Point Gripping Pliers 200mm
17352	1PC Combination Pliers 200mm Light Insulation
17361	1PC Long Nose Pliers 200mm Insulated Handles
17370	1PC Diagonal Cutters 150mm
17385	1PC Multigrips 250mm



80160

**60PC IMPACT SOCKET HDFI TRAY**

80082

Size	564 X 270 X 22mm
<b>Code</b>	<b>Description</b>
80082T	1PC High Density Foam Insert Tray
11320	20PC 1/2" Drive Impact Standard & Deep Socket Set AF: Standard Sizes: 3/8 - 15/16", Deep Sizes: 7/16 - 1"
11321	20PC 1/2" Drive Impact Standard & Deep Socket Set Metric: Standard Sizes: 10 - 22mm, Deep Sizes: 10 - 24mm
11322	8PC 1/2" Drive Impact In-Hex Socket Set AF: 1/4 - 3/4"
11323	8PC 1/2" Drive Impact In-Hex Socket Set Metric: 10 - 19mm
11325	1PC 1/2" Drive Impact Universal Joint
11328	1PC 1/2" Drive Impact Extension Bar 75mm
11329	1PC 1/2" Drive Impact Extension Bar 125mm
11330	1PC 1/2" Drive Impact Extension Bar 250mm



80082

**26PC 3/4"DR SOCKET HDFI TRAY**

80196

Size	564 X 400 X 22mm
<b>Code</b>	<b>Description</b>
80196T	1PC High Density Foam Insert Tray
A13362	26PC 3/4" Drive Socket Set Metric & AF: Metric: 22- 50mm, AF: 1- 2", 2 Extensions 100 & 200mm, 1 Ratchet & 1 Sliding T Bar 460mm



80196

# 1. Tool Kits & Inserts



80155

## 77PC SOCKET HDFI TRAY

80155

Size	564 X 400 X 22mm
Code	Description
80155T	1PC High Density Foam Insert Tray
A13355	8PC 1/4" Drive Deep Socket Set AF: 3/16 to 1/2"
A13356	8PC 1/4" Drive Deep Socket Set Metric: 5 to 12mm
A13315	8PC 3/8" Drive Deep Socket Set AF: 3/8 to 13/16"
A13316	8PC 3/8" Drive Deep Socket Set Metric: 10 to 19mm
A13694	10PC 1/2" Drive Deep Socket Set AF: 3/8 to 15/16"
A13695	12PC 1/2" Drive Deep Socket Set Metric: 10 to 22mm
13668	10PC 1/2" Drive In-Hex Socket Set AF: 5/32 to 3/4"
13669	10PC 1/2" Drive In-Hex Socket Set Metric: 4 to 19mm
WB309	1PC 3/8" Drive Wobble Extension Bar 250mm
WB34	1PC 1/2" Drive Wobble Extension Bar 250mm
WB36	1PC 1/2" Drive Wobble Extension Bar 500mm



80400

## 31PC CROWS FOOT HDFI TRAY

80400

Size	564 X 113 X 22mm
Code	Description
80400T	1PC High Density Foam Insert Tray
11220	12PC 3/8" & 1/2" Drive Crows Foot Set AF: 3/8" Drive: 5/16 - 11/16", 1/2" Drive: 13/16 - 1"
11221	15PC 3/8" & 1/2" Drive Crows Foot Set Metric: 3/8" Drive: 8 - 19mm, 1/2" Drive: 21 - 24mm
11218	1PC 3/8" Drive Impact Extension Bar 75mm
11219	1PC 3/8" Drive Impact Extension Bar 150mm
11216	1PC 3/8" Drive Impact Universal Joint
11326	1PC Adaptor 1/2"F to 3/8"M



80402

## 5PC SCRAPER / PODGER HDFI TRAY

80402

Size	564 X 113 X 22mm
Code	Description
80402T	1PC High Density Foam Insert Tray
07118	1PC Podger Bar 450mm
08103	3PC Gasket Scraper Set
08319	1PC Scribe Straight & Angle Point



80404

## 3PC TINSNIP HDFI TRAY

80404

Size	564 X 113 X 22mm
Code	Description
80404T	1PC High Density Foam Insert Tray
17250	1PC Tinsnips Right Cut Action 250mm Green Handle
17251	1PC Tinsnips Left Cut Action 250mm Red Handle
17252	1PC Tinsnips Straight Cut Action 250mm Yellow Handle



80406

## 2PC MULTIGRIP HDFI TRAY

80406

Size	564 X 113 X 22mm
Code	Description
80406T	1PC High Density Foam Insert Tray
17380	1PC Multigrips 250mm
17387	1PC Multigrips Heavy Duty 400mm



**4PC ADJUSTABLE WRENCH HDFI TRAY** 80408

Size	564 X 113 X 22mm
<b>Code</b>	<b>Description</b>
80408T	1PC High Density Foam Insert Tray
A13028	1PC Adjustable Wrench 150mm
A13029	1PC Adjustable Wrench 200mm
A13030	1PC Adjustable Wrench 250mm
A13031	1PC Adjustable Wrench 300mm



80408

**8PC LONG RING SPANNER HDFI TRAY** 80410

Size	564 X 113 X 22mm
<b>Code</b>	<b>Description</b>
80410T	1PC High Density Foam Insert Tray
A13160	4PC Long Ring Spanner Set Metric: 8 x 10 - 22 x 24mm
A13167	4PC Long Ring Spanner Set AF: 3/8 x 7/16 - 7/8 x 15/16"



80410

**11PC MIRRORS, PICK SET, MEASURING, CIRCUIT TESTER HDFI TRAY** 80414

Size	564 X 113 X 22mm
<b>Code</b>	<b>Description</b>
80414T	High Density Foam Insert Tray
16390	4PC Hook & Pick Set
08308	4PC Telescopic Magnets & Mirrors Set
10427	1PC 12V Needle Probe Tester (Brass Circuit Tester)
08572	1PC Dual Type Standard Tyre Gauge
50171	1PC 300mm Steel Rule Metric & Imperial



80414

**7PC RATCHET HANDLE / EXTENSION BAR HDFI TRAY** 80420

Size	564 X 113 X 22mm
<b>Code</b>	<b>Description</b>
80420T	High Density Foam Insert Tray
KC407	1PC 1/4" Drive Extension Bar Hex Head 250mm
KC310	1PC 3/8" Drive Extension Bar Hex Head 250mm
KC320	1PC 3/8" Drive Extension Bar Hex Head 500mm
ZDA20	1PC 1/2" Drive Extension Bar Hex Head 500mm
NH15	1PC 1/4" Drive Flex Head Stubby Banjo Ratchet
NH36	1PC 3/8" Drive Flex Head Stubby Banjo Ratchet
NH10	1PC 1/2" Drive Flex Head Stubby Banjo Ratchet



80420

# 1. Tool Kits & Inserts



80610

## 88PC SOCKET HDFI TRAY

80610

Code	Description
80610T	1PC High Density Foam Insert Tray
A13330	45PC 1/4" & 3/8" Drive Socket Set Metric & AF: 1/4" Drive: 9 Metric Sockets: 4 - 12mm, 9 AF Sockets: 3/16 - 1/2", 3/8" Drive: 7 12 Metric Sockets: 8 - 19mm, AF Sockets: 3/8 - 3/4", 1 Adaptor 3/8 F to 1/4" M & 1 Spark Plug Socket 5/8"
A13170	43PC 1/2" Drive Socket Set Metric & AF: 20 Metric Sockets: 8 - 32mm, 14 AF Sockets: 3/8 - 1-1/4", 1 Universal Joint, 1 Adaptor 1/2 F to 3/8" M 2 Spark Plug Sockets 5/8 & 13/16"

Wall cabinet insert.



80500

## 45PC SOCKET HDFI TRAY

80500

Code	Description
80500T	1PC High Density Foam Insert Tray
A13330	45PC 1/4" & 3/8" Drive Socket Set Metric & AF: Metric: 4 - 12mm, 1/4" Drive: AF: 3/16 - 1/2", 1 Spinner Handle & 2 Extensions 50 & 150mm. 3/8" Drive: Metric: 8 to 19mm, AF: 3/8 to 3/4", 1 Banjo Ratchet, 2 Extensions 75 & 150mm, 1 Adaptor 3/8" F to 1/4" M & 1 Spark Plug Socket 5/8"

Cantilever insert.



80436

## 3PC ADAPTOR HDFI TRAY

80436

Size	70 X 54 X 19mm
Code	Description
80436T	1PC High Density Foam Insert Tray
10355	3PC Power Tool Adaptor Set



80704

## 7PC PIN PUNCH VFI TRAY

80704

Size	170 x 270 x 46mm
Code	Description
A7233	1PC Industrial Centre Punch No. 6.5
A7202	1PC Long Series Pin Punch 3mm
A7203	1PC Long Series Pin Punch 4mm
A7204	1PC Long Series Pin Punch 5mm
A7205	1PC Long Series Pin Punch 6mm
A7252	1PC Long Series Pin Punch 12mm
A7253	1PC Long Series Pin Punch 16mm



**54PC HEX & STAR BIT VFI TRAY**

80706

Size	170 x 270 x 46mm
<b>Code</b>	<b>Description</b>
A13390	54PC Hex & Star Bit Set: 9 AF Hex Bits 30mm Long, 8 Metric Hex Bits 30mm Long, 2 AF Hex Bits 75mm Long, 3 Metric Hex Bits 75mm Long, 9 Star Bits 30mm Long, 3 Star Bits 75mm Long, 11 Tamperproof Bits, 5 Spline Bits 30mm Long, 2 Spline Bits 75mm Long & 2 Bit Adaptors



80706

**3PC PLIER VFI TRAY**

80708

Size	170 x 270 x 46mm
<b>Code</b>	<b>Description</b>
17352	1PC Combination Pliers 200mm
17361	1PC Long Nose Pliers 200mm
17371	1PC Diagonal Cutters 150mm



80708

**88PC SOCKET VFI TRAY**

80702

Size	540 x 270 x 46mm
<b>Code</b>	<b>Description</b>
A13330	45PC 1/4" & 3/8" Drive Socket Set Metric & AF: 1/4" Drive: Metric: 4 - 12mm, AF: 3/16 - 1/2", 1 Spinner Handle & 2 Extensions 50 & 150mm. 3/8" Drive: Metric: 8 - 19mm, AF : 3/8 - 3/4", 1 Banjo Ratchet, 2 Extensions 75 & 150mm, 1 Adaptor 3/8F to 1/4" M & 1 Spark Plug Socket 5/8"
A13170	43PC 1/2" Drive Socket Set Metric & AF: Metric: 8 - 32mm, AF : 3/8 - 1-1/4", 1 Banjo Ratchet, 1 Flex Head Bar 380mm, 3 Extensions 75, 125 & 250mm, 1 Universal Joint, 1 Adaptor 1/2F to 3/8" M & 2 Spark Plug Sockets 5/8 & 13/16"



80702

**24PC COMBINATION SPANNER VFI TRAY**

80710

Size	540 x 270 x 46mm
<b>Code</b>	<b>Description</b>
A13328	24PC Combination Spanner Set Metric & AF: Metric: 7 - 21mm AF: 1/4 - 15/16"



80710

**13PC SCREWDRIVER, HAMMER, ADJUSTABLE WRENCH, PLIER VFI TRAY**

80712

Size	540 x 270 x 46mm
<b>Code</b>	<b>Description</b>
12404	1PC Trimming Knife
16300	7PC Anti-Slip Screwdriver Set
17380	1PC Multigrips 250mm
17024	1PC Locking Pliers 250mm
14092	1PC Ball Pein Hammer 450g
A13030	1PC 250mm Adjustable Wrench
A13028	1PC 150mm Adjustable Wrench



80712

# 1. Tool Kits & Inserts



90000

## 84PC SOCKET HDFI TRAY

90000

Size	624 x 270 x 19mm
Code	Description
90000T	High Density Foam Insert Tray
10100	39PC 1/4 & 3/8" Drive Socket Set Metric & AF: 1/4" Drive: AF: 3/16 - 1/2", Metric: 4 - 12mm, Spinner Handle 150mm, 3/8" Drive: AF: 3/8 - 3/4", Metric: 9 - 19mm, Extension 75mm, Adaptor 3/8 F to 1/4" M, Spark Plug Socket 5/8", Banjo Ratchet
10120	40PC 1/2" Drive Socket Set Metric & AF: AF: 3/8 - 1-1/4", Metric: 10 - 32mm, Extensions 125 & 250mm, Uni. Joint, Spark Plug Sockets 13/16 & 5/8", Sliding T Bar 250mm, 1 Banjo Ratchet
AZDA315	1PC 1/2" Drive Breaker Bar 375mm
10160	1PC 1/4" Drive Banjo Ratchet
AKC1238	1PC Adaptor 1/2" Female To 3/8" Male
AKC403	1PC Extension Bar Hex Head 50mm
AKC406	1PC Extension Bar Hex Head 150mm



90500

## 39PC HDFI TRAY

90500

Size	453 x 94 x 30mm
Code	Description
90500T	High Density Foam Insert Tray
10100	39PC 1/4 & 3/8" Drive Socket Set Metric & AF: 1/4" Drive: AF: 3/16 - 1/2", Metric: 4 - 12mm, Spinner Handle 150mm, 3/8" Drive: AF: 3/8 - 3/4", Metric: 9 - 19mm, Extension 75mm, Adaptor 3/8 F to 1/4" M, Spark Plug Socket 5/8", Banjo Ratchet





**We  
understand  
how  
precious  
your tools  
are.**

That's why, at KC Tools, we are committed to giving you the highest quality storage and security systems for your valuable tools. Our fully stackable 5, 6 and 9-drawer tool boxes feature ball bearing slides, heavy duty side handles, powder coat finish and an internal locking system. Our 10-drawer boxes and roll cabinets deliver unequalled quality for the hardened professional, whilst our cantilever, ute box and wall cabinets offer further flexibility.

Our tool boxes allow you to store your tools to not only protect them but lets you quickly and easily get your hands on them when you need them most.



# 2. Tool Boxes & Storage



A22114

## 7 DRAWER TOOL BOX

A22114

Sizes (mm)	Carton Size (mm)	Gross Weight (kg)	Net Weight (kg)	Keys
712 x 472 x 475	790 x 548 x 559	44	42	2
Drawer Info	2 Drawers	1 Drawer	1 Drawers	3 Drawer
Size (mm)	170 x 410 x 48	142 x 410 x 48	570 x 410 x 48	570 x 410 x 74.5
Capacity (kg)	8	8	10	20

Featuring heavy duty side handles, tribostatic powder coated finish, internal locking system for extra security, 2mm protective non-slip drawer liners and the tool box is fully stackable.



RED

FLAME

JET



A22150

## 5 DRAWER TOOL BOX

A22150

Sizes (mm)	Carton Size (mm)	Gross Weight (kg)	Net Weight (kg)	Keys
668 x 445 x 461	745 x 520 x 540	40.9	38.4	2
Drawer Info	Top Tray Area	3 Drawers	2 Drawers	
Size (mm)	668 x 441 x 71	570 x 410 x 48	570 x 410 x 74.5	
Capacity (kg)	20	15	20	

Featuring heavy duty side handles, tribostatic powder coated finish, internal locking system for extra security, 2mm protective non-slip drawer liners, drawer index cards and the tool box is fully stackable.



RED

FLAME

JET



A22104

## 10 DRAWER TOOL BOX

A22104

Sizes (mm)	Carton Size (mm)	Gross Weight (kg)	Net Weight (kg)	Keys
712 x 472 x 474	790 x 548 x 559	52.5	50	2
Drawer Info	6 Drawers	1 Drawer	2 Drawers	1 Drawer
Size (mm)	170.5 x 410 x 48	142 x 410 x 153	570 x 410 x 48	570 x 410 x 74.5
Capacity (kg)	8	10	10	20

Featuring heavy duty side handles, tribostatic powder coated finish, internal locking system for extra security, 2mm protective non-slip drawer liners, drawer index cards and the tool box is fully stackable.



RED

FLAME

JET



**7 DRAWER ROLL CABINET**

A22112

Sizes (mm)	Carton Size (mm)	Gross Weight (kg)	Net Weight (kg)	Keys
712 x 472 x 1010	790 x 548 x 930	67.5	65	2
<b>Drawer Info</b>	<b>5 Drawers</b>	<b>2 Drawers</b>		
Size (mm)	570 x 410 x 74.5	570 x 410 x 153.4		
Capacity (kg)	20	80		

Featuring sturdy angled corners for extra strength, dual ball bearing slides on the deep lower drawers, heavy duty side handle and tribostatic powder coated finish.



**RED**

**FLAME**

**JET**



A22112

**13 DRAWER ROLL CABINET**

A22105

Sizes (mm)	Carton Size (mm)	Gross Weight (kg)	Net Weight (kg)	Keys
1355 x 472 x 1011	1406 x 525 x 1220	151	123	2
<b>Drawer Info</b>	<b>1 Drawers</b>	<b>10 Drawers</b>	<b>2 Drawers</b>	
Size (mm)	1200.5 x 410 x 165.5	570 x 410 x 74.5	570 x 410 x 153.5	
Capacity (kg)	-	40	50	

Featuring ball bearing slides, heavy duty side handle, tribostatic powder coated finish.



**RED**

**FLAME**

**JET**



A22105

**OPTIONAL TOOL STORAGE ACCESSORIES**

A22000-A22002

Code	Description	Weight (grams)	Sizes (mm)
A22000	Peg Board To Suit A22110 & A22112	-	-
A22001	Side Tray To Suit A22110 & A22112	1250	460 x 100
A22002	Tools Holder To Suit A22110 & A22112	-	-

Used as a holder for tools and ancillaries. Available in red or black.

**RED**

**JET**

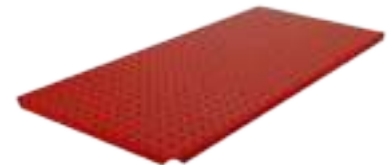

A22000



A22001



A22002

# 2. Tool Boxes & Storage



A12107B

## 7 DRAWER TOOL BOX

A12107B

Sizes (mm)	Carton Size (mm)	Gross Weight (kg)	Net Weight (kg)	Keys
1055 x 470 x 555	1125 x 532 x 700	73.5	63.8	2
<b>Drawer Info</b>	<b>1 Drawer</b>	<b>2 Drawers</b>	<b>1 Drawer</b>	
Size (mm)	570 x 410 x 54	570 x 410 x 83	570 x 410 x 112	
Capacity (kg)	-	-	-	
<b>Drawer Info</b>	<b>1 Drawer</b>	<b>1 Drawer</b>	<b>1 Drawer</b>	
Size (mm)	313 x 410 x 54	313 x 410 x 83	313 x 410 x 199	
Capacity (kg)	-	-	-	

Ideal in combination with A12171, 11 drawer roll cabinet. Featuring ball bearing slides, heavy duty side handles, extra strength rolled drawer edges, tribostatic powder coated finish, 2mm protective non-slip drawer liners, drawer index cards and the tool box is fully stackable.



**JET**



A12111B

## 13 DRAWER ROLL CABINET

A12111B

Sizes (mm)	Carton Size (mm)	Gross Weight (kg)	Net Weight (kg)	Keys
1355 x 472 x 1060	1407 x 525 x 1130	137	117	2
<b>Drawer Info</b>	<b>10 Drawers</b>	<b>2 Drawers</b>	<b>1 Drawer</b>	
Size (mm)	570 x 410 x 74.5	570 x 410 x 153.5	1200.5 x 410 x 165.5	
Capacity (kg)	-	-	-	

Ideal in combination with A12107B, 7 drawer tool box. Featuring ball bearing slides, heavy duty side handles, extra strength rolled drawer edges, tribostatic powder coated finish, 2mm protective non-slip drawer liners.



**JET**

## 3 DRAWER TOOL BOX

A12115

Sizes (mm)	Carton Size (mm)	Gross Weight (kg)	Net Weight (kg)	Keys
670 x 315 x 265	734 x 376 x 343	16.4	14.7	2
<b>Drawer Info</b>	<b>2 Drawers</b>	<b>1 Drawer</b>		
Size (mm)	570 x 273 x 48	570 x 273 x 74.5		
Capacity (kg)	10	18		

Ideal in combination with A12100, 6 drawer tool box or the A12102, 9 drawer tool box. Featuring heavy duty side handles, tribostatic powder coated finish, internal locking system for extra security, 2mm protective non-slip drawer liners, drawer index cards and the tool box is fully stackable.



**RED**

**JET**



A12115





A22110

**3 DRAWER ROLL CABINET**

A22110

Sizes (mm)	Carton Size (mm)	Gross Weight (kg)	Net Weight (kg)	Keys
680 x 458 x 995	749 x 520 x 935	49	45	2

Drawer Info	2 Drawers	6 Drawers	Cupboard Area
Size (mm)	570 x 710 x 74.5	571 x 410 x 153.5	600 x 420 x 360
Capacity (kg)	25	25	25

Featuring ball bearing slides, heavy duty side handle, tribostatic powder coated finish.



- A22110
- A22110O
- A22110B



A22112

**7 DRAWER ROLL CABINET**

A22112

Sizes (mm)	Carton Size (mm)	Gross Weight (kg)	Net Weight (kg)	Keys
712 x 472 x 1010	790 x 548 x 930	67.5	65	2

Drawer Info	5 Drawers	2 Drawers
Size (mm)	570 x 410 x 74.5	570 x 410 x 153.4
Capacity (kg)	20	80

Featuring sturdy angled corners for extra strength, dual ball bearing slides on the deep lower drawers, heavy duty side handle and tribostatic powder coated finish.



- A22112
- A22112O
- A22112B

**6 DRAWER TOOL BOX**

A12100

Sizes (mm)	Carton Size (mm)	Gross Weight (kg)	Net Weight (kg)	Keys
660 x 307 x 377	726 x 368 x 455	24.8	22.1	2

Drawer Info	Top Tray Area	3 Drawers	2 Drawers	1 Drawer
Size (mm)	658 x 303 x 70	107.5 x 273 x 48	570 x 273 x 48	570 x 273 x 74.5
Capacity (kg)	20	10	15	15

Featuring ball bearing slides, heavy duty side handles, tribostatic powder coated finish, internal locking system for extra security, 2mm protective non-slip drawer liners, drawer index cards and the tool box is fully stackable.



- RED**
- JET**



A12100

# 2. Tool Boxes & Storage



A12102

## 9 DRAWER TOOL BOX

A12102

Sizes (mm)	Carton Size (mm)	Gross Weight (kg)	Net Weight (kg)	Keys
660 x 307 x 435	726 x 368 x 512	31.7	28.2	2

Drawer Info	Top Tray Area	6 Drawers	2 Drawers	1 Drawer
Size (mm)	658 x 303 x 70	170.5 x 273 x 48	570 x 273 x 48	570 x 273 x 74.5
Capacity (kg)	20	10	15	15

Featuring ball bearing slides, heavy duty side handles, tribostatic powder coated finish, internal locking system for extra security, 2mm protective non-slip drawer liners, drawer index cards and the tool box is fully stackable.



**RED**

**JET**





**10 DRAWER TOOL BOX**

A12170

Sizes (mm)	Carton Size (mm)	Gross Weight (kg)	Net Weight (kg)	Keys
1051 x 445 x 552	1130 x 515 x 725	77.5	66.3	2
Drawer Info	Top Tray Area	5 Drawers	5 Drawers	
Size (mm)	1048 x 441 x 70	570 x 410 x 74.5	313 x 410 x 74.5	
Capacity (kg)	15	25	25	

Ideal in combination with A12171, 11 drawer roll cabinet. Featuring ball bearing slides, heavy duty side handles, extra strength rolled drawer edges, tribostatic powder coated finish, 2mm protective non-slip drawer liners, drawer index cards and the tool box is fully stackable.



A12170

**11 DRAWER ROLL CABINET**

A12171

Sizes (mm)	Carton Size (mm)	Gross Weight (kg)	Net Weight (kg)	Keys
1067 x 458 x 1007	1146 x 530 x 1085	140	110	2
Drawer Info	1 Drawer	3 Drawers	2 Drawers	
Size (mm)	937 x 410 x 122.5	570 x 410 x 74.5	570 x 410 x 153.5	
Capacity (kg)	39	26	30	
Drawer Info	3 Drawers	2 Drawers		
Size (mm)	313 x 410 x 74.5	313 x 410 x 153.5		
Capacity (kg)	23	28		

Ideal in combination with A12170, 10 drawer tool box or the A12102, 9 drawer tool box. Featuring heavy duty side handles, extra strength rolled drawer edges, welded bottom frame for high strength, tribostatic powder coated finish, 2mm protective non-slip drawer liners and drawer index cards.



A12171



# 2. Tool Boxes & Storage



A10052R

## 6 DRAWER TOOL BOX

A10052R

Sizes (mm)	Carton Size (mm)	Gross Weight (kg)	Net Weight (kg)	Keys
660 x 308 x 380	730 x 360 x 430	23	21.5	2
Drawer Info	Top Tray Area	3 Drawers	2 Drawers	1 Drawer
Size (mm)	629 x 274 x 53	172 x 270 x 50	570 x 270 x 50	572 x 270 x 74.5
Capacity (kg)	15	8	15	20

Ball bearing slides. Tool box is supplied with non slip matting for each drawer and drawer index cards with plastic strips.



**RED**



A10059R

## 9 DRAWER TOOL BOX

A10059R

Sizes (mm)	Carton Size (mm)	Gross Weight (kg)	Net Weight (kg)	Keys
660 x 308 x 435	730 x 360 x 480	27.5	26	2
Drawer Info	Top Tray Area	6 Drawers	2 Drawers	1 Drawer
Size (mm)	629 x 274 x 53	172 x 270 x 50	570 x 270 x 50	570 x 270 x 75
Capacity (kg)	15	8	15	20

Ball bearing slides. Tool box is supplied with non slip matting for each drawer and drawer index cards with plastic strips.



**RED**



A10056R

## 7 DRAWER ROLL CABINET

A10056R

Sizes (mm)	Carton Size (mm)	Gross Weight (kg)	Net Weight (kg)	Keys
670 x 460 x 810	750 x 530 x 870	49	46.5	2
Drawer Info	1 Drawer	3 Drawers	2 Drawers	1 Drawer
Size (mm)	570 x 410 x 48	570 x 410 x 74.5	570 x 410 x 100.5	570 x 410 x 153.5
Capacity (kg)	10	15	20	25

Ball bearing slides. Roll cabinet is supplied with non slip matting for each drawer and top and drawer index cards with plastic strips. 4 x 126mm x 32mm casters, 2 swivel with lockable brakes and 2 fixed.



**RED**



**2 DRAWER TOOL BOX**

A10053R

Sizes (mm)	Carton Size (mm)	Gross Weight (kg)	Net Weight (kg)	Keys
660 x 310 x 256	730 x 360 x 310	12.5	11.5	2
<b>Drawer Info</b>	<b>1 Drawers</b>	<b>1 Drawer</b>		
Size (mm)	570 x 270 x 50	570 x 270 x 75		
Capacity (kg)	15	20		

Ball bearing slides. Tool box is supplied with non slip matting for each drawer and drawer index cards with plastic strips.



**RED**



A10053R

**HANDYMAN TOOL BOX**

A12180

Sizes (mm)	Carton Size (mm)	Gross Weight (kg)	Net Weight (kg)
430 x 177 x 190	470 x 226 x 243	3.4	2.9
<b>Drawer Info</b>	<b>1 Tray</b>		
Size (mm)	412 x 157 x 68		
Capacity (kg)	5		



A12180

**WALL MOUNTING TOOL BOX**

TCW1

Sizes (mm)	Carton Size (mm)	Gross Weight (kg)	Net Weight (kg)	Keys
661 x 194 x 911	720 x 260 x 980	28.5	26	2
<b>Drawer Info</b>	<b>1 Drawer</b>			
Size (mm)	14.5 x 6 x 58			

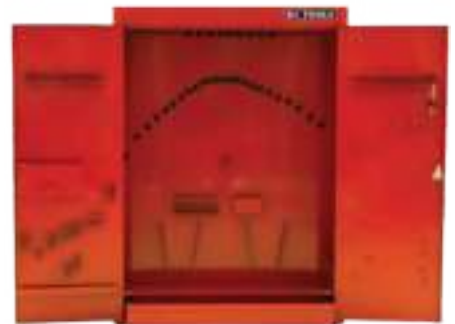

TCW1

**5 TRAY CANTILEVER TOOL BOX**

A12182

Sizes (mm)	Carton Size (mm)	Gross Weight (kg)	Net Weight (kg)
466 x 210 x 232	485 x 255 x 280	4.9	4.2
<b>Drawer Info</b>	<b>4 Trays</b>	<b>1 Tray</b>	
Size (mm)	460 x 102.5 x 63.5	460 x 204.5 x 102	
Capacity (kg)	5	10	



A12182

# 2. Tool Boxes & Storage



UB3

## 3 DRAWER UTE BOX

UB3

Sizes (mm)	Carton Size (mm)	Gross Weight (kg)	Net Weight (kg)
735 x 465 x 586	780 x 500 x 640	60	57.5

Drawer Info	Top Tray Area	2 Removable Trays	1 Drawer with 4 Divisions	2 Drawers
Size (mm)	706 x 425 x 130	287 x 370 x 57.5	575 x 410 x 72.5	575 x 410 x 72.5
Capacity (kg)	30	15	30	30

Box is made from heavy grade steel plate with a powder coat finish. Weather Resistant



UBA2

## 2 DRAWER ANGLE TOP UTE BOX

UBA2

Sizes (mm)	Carton Size (mm)	Gross Weight (kg)	Net Weight (kg)
700 x 400 x 585	775 x 465 x 660	43	39

Drawer Info	Top Area	2 Drawers
Size (mm)		628 x 371 x 103
Capacity (kg)		30

Box is made from heavy grade steel plate with a powder coat finish. Weather Resistant



UBA23

## LARGE 2 DRAWER ANGLE TOP UTE BOX

UBA23

Sizes (mm)	Carton Size (mm)	Gross Weight (kg)	Net Weight (kg)
700 x 600 x 750	775 X 665 X 825	58	53

Drawer Info	Top Area	2 Drawers
Size (mm)		628 x 571 x 103
Capacity (kg)		30

Box is made from heavy grade steel plate with a powder coat finish. Weather Resistant



TB75UL-TB75UR

## STEEL TRUCK WHEEL BOXES

TB75UL-TB75UR

Code	Description	Size (mm)
TB75UL	Steel Truck Wheel Box (Left)	660 x 270 x 410
TB75UR	Steel Truck Wheel Box (Right)	660 x 270 x 410

Made of 1.5mm cold steel plate. Heavy duty stainless steel t-locks. Industrial strength powder coating. Anti-dust rubber seal.



**2 DRAWER ANGLE TOP UTE BOX WITH CLOSE FRONT** UBA22

Sizes (mm)	Carton Size (mm)	Gross Weight (kg)	Net Weight (kg)
700 x 400 x 585	775 x 465 x 660	43	39

Drawer Info	Top Tray Area	2 Drawers
Size (mm)	-	628 x 371 x 103
Capacity (kg)	-	30

Box is made from heavy grade steel plate with a powder coat finish. Weather Resistant



UBA22

**WIDE 2 DRAWER ANGLE TOP UTE BOX** UBA2W

Sizes (mm)	Carton Size (mm)	Gross Weight (kg)	Net Weight (kg)
1210 x 600 x 750	1285 x 665 x 825	91.5	85

Drawer Info	Top Tray Area	2 Drawers
Size (mm)	-	1285 x 665 x 825
Capacity (kg)	-	30

Box is made from heavy grade steel plate with a powder coat finish. Weather Resistant



UBA2W

**EXTRA WIDE 2 DRAWER ANGLE TOP UTE BOX** UBA2XW

Sizes (mm)	Carton Size (mm)	Gross Weight (kg)	Net Weight (kg)
1500 x 600 x 750	1575 x 665 x 825	110.5	103

Drawer Info	Top Tray Area	4 Drawers
Size (mm)	-	1575 x 665 x 825
Capacity (kg)	-	30

Box is made from heavy grade steel plate with a powder coat finish. Weather Resistant



UBA2XW

## 3. Socket Sets & Accessories



**Time to  
loosen up.**



KC Tools quality socket sets are designed for tolerance, durability and longevity and come in many different sizes so they can perfectly fit in the palm of your hand. Our range of socket sets and accessories consist of 1/4", 3/8", 1/2", 3/4", 1". We offer multiple drive sets and individual standard and deep type sockets.

All our sets are carefully designed and offer a complete range for professional and industrial applications.



# 3. Socket Sets & Accessories



A13356

## 1/4" DR SOCKET SET DEEP 8PC

A13356



Code	Size (mm)	Code	Size (mm)	Code	Size (mm)
A14475	5	A14478	8	A14481	11
A14476	6	A14479	9	A14482	12
A14477	7	A14480	10	-	-

Metric set. Packaged in a vacuum formed insert in a metal storage case. EVA schematic diagram with all contents listed in the lid. Vacuum formed insert printed with socket sizes and details.



A13355

## 1/4" DR SOCKET SET DEEP 8PC

A13355



Code	Size (inch)	Code	Size (inch)	Code	Size (inch)
A14465	3/16	A14468	9/32	A14471	7/16
A14466	7/32	A14469	5/16	A14472	1/2
A14467	1/4	A14470	3/8	-	-

AF set. Packaged in a vacuum formed insert in a metal storage case. EVA schematic diagram with all contents listed in the lid. Vacuum formed insert printed with socket sizes and details.



A13225

## 1/4" DR SOCKET SET 26PC

A13225



Code	Size	Code	Size	Code	Description
A14420	4mm	A14410	3/16"	NH16	Ratchet
A14422	5mm	A14410-5	7/32"	A14721	Spinner
A14424	6mm	A14411	1/4"	AKC405	Sliding T Bar
A14425	7mm	A14411-5	9/32"	AKC403	50mm Ext
A14426	8mm	A14412	5/16"	AKC406	150mm Ext
A14427	9mm	A14412-5	11/32"	AZDA114	Uni Joint
A14428	10mm	A14413	3/8"	AKC402	150mm Flex
A14429	11mm	A14414	7/16"	-	-
A14430	12mm	A14415	1/2"	-	-
A14431	13mm	-	-	-	-

Metric & AF set. Packaged in a vacuum formed insert in a metal storage case. EVA schematic diagram with all contents listed in the lid. Vacuum formed insert printed with socket sizes and details.



**1/4" DR SOCKETS METRIC**

A14420-A14432

Standards:			DIN 3124	
Code	Size (mm)	Weight (grams)	Diameter (mm)	Length (mm)
A14420	4	10	6	25
A14421	4.5	9	7	25
A14422	5	12	7	25
A14423	5.5	10	8	25
A14424	6	12	9	25
A14425	7	12	11	25
A14426	8	12	12	25
A14427	9	18	13	25
A14428	10	18	14	25
A14429	11	24	16	25
A14430	12	28	17	25
A14431	13	21	18	25
A14432	14	24	20	25



A14420-A14432

Single hex sockets.

**1/4" DR SOCKETS DEEP METRIC**

A14475-A14484

Standards:			DIN 899E	
Code	Size (mm)	Weight (grams)	Diameter (mm)	Length (mm)
A14475	5	20	12	50
A14476	6	20	12	50
A14477	7	24	12	50
A14478	8	35	12	50
A14479	9	35	13	50
A14480	10	43	14	50
A14481	11	65	16	50
A14482	12	65	17	50
A14483	13	51	18	50
A14484	14	70	20	50



A14475-A14484

Single hex deep sockets.

**1/4" DR SOCKETS AF**

A14410-A14415

Standards:			DIN 3124	
Code	Size (inch)	Weight (grams)	Diameter (mm)	Length (mm)
A14410	3/16	12	7	25
A14410-5	7/32	12	8	25
A14411	1/4	12	10	25
A14411-5	9/32	12	12	25
A14412	5/16	12	12	25
A14412-5	11/32	18	13	25
A14413	3/8	18	14	25
A14414	7/16	24	16	25
A14415	1/2	32	18	25



A14410-A14415

Single hex sockets.

**1/4" DR SOCKETS DEEP AF**

A14465-A14472

Standards:			DIN 899E	
Code	Size (inch)	Weight (grams)	Diameter (mm)	Length (mm)
A14465	3/16	21	12	50
A14466	7/32	18	12	50
A14467	1/4	20	12	50
A14468	9/32	24	12	50
A14469	5/16	35	12	50
A14470	3/8	43	14	50
A14471	7/16	65	16	50
A14472	1/2	59	18	50



A14465-A14472

Single hex deep sockets.

# 3. Socket Sets & Accessories

## 1/4" DR SOCKETS STAR

A14401-A14406



A14401-A14406

Code	Size	Weight (grams)	Diameter (mm)	Length (mm)
A14401	T10	12	11.2	38.2
A14402	T15	12	11.2	38.2
A14403	T20	12	11.2	38.2
A14404	T25	12	11.2	38.2
A14405	T27	12	11.2	38.2
A14406	T50	13	11.2	38.2

## 1/4" DR BANJO RATCHET

NH14



NH14

Standards:		DIN 3122			
Code	Description	Weight (grams)	Length (mm)	Torque (Nm)	Teeth
NH14	Standard	140	142	75	72

Auto-eject. Repair kit and spare parts available.

## 1/4" DR BANJO RATCHET

NH16



NH16

Standards:		DIN 3122			
Code	Description	Weight (grams)	Length (mm)	Torque (Nm)	Teeth
NH16	Standard	140	140	75	45

Auto-eject. Repair kit and spare parts available.

## 1/4" DR FLEX HEAD BANJO RATCHET

NH15



NH15

Standards:		DIN 3122			
Code	Description	Weight (grams)	Length (mm)	Torque (Nm)	Teeth
NH15	Flex Head Stubby	140	123	62	72

Auto-eject. Repair kit and spare parts available.

## 1/4" DR SPINNER HANDLE

A14721



A14721

Standards:		899E	
Code	Description	Weight (grams)	Length (mm)
A14721	Spinner Handle	95	150

Plastic handle. Can be used as an extension. For driving manually operated 1/4" DR sockets and accessories.

## 1/4" DR SLIDING T HANDLE

AKC405



AKC405

Standards:		DIN 3124	
Code	Description	Weight (grams)	Length (mm)
AKC405	Sliding T Handle	42	115

## 1/4" DR FLEX HEAD BAR

AKC402



AKC402

Standards:		DIN 3124	
Code	Description	Weight (grams)	Length (mm)
AKC402	Flex Head Bar	100	150

Spare head and pin available.



## 1/4" DR EXTENSIONS

AKC403-AKC406

Standards:		DIN 3124	
Code	Description	Weight (grams)	Length (mm)
AKC403	Extension Bar	23	50
AKC404	Extension Bar	45	100
AKC406	Extension Bar	64	150

Round head.



AKC403-AKC406

## 1/4" DR LONG EXTENSIONS

KC407-KC408

Standards:		DIN 3120	ANSI B107.2-1975
Code	Description	Weight (grams)	Length (mm)
KC407	Extension Bar	107	250
KC408	Extension Bar	145	350

Hex head.



KC407-KC408

## 1/4" DR WOBBLE EXTENSIONS

WB415-WB419

Standards:		DIN 3120	ANSI B107.2-1975
Code	Description	Weight (grams)	Length (mm)
WB415	Wobble Ext. Bar	24	50
WB417	Wobble Ext. Bar	63	150
WB419	Wobble Ext. Bar	108	250



WB415-WB419

## 1/4" DR FLEXIBLE EXTENSION

10181

Standards:		DIN 3124	
Code	Description	Weight (grams)	Length (mm)
10181	Flexible Extension	70	145

HRC 44 - 48 degree.



10181

## 1/4" DR ADAPTOR

KC1438

Code	Description	Weight (grams)	Diameter (mm)	Length (mm)
KC1438	1/4" F to 3/8" M	15	12	25



KC1438

## 1/4" DR UNIVERSAL JOINT

AZDA114

Standards:		DIN 3124		
Code	Size (inch)	Weight (grams)	Diameter (mm)	Length (mm)
AZDA114	1/4	28	14	32



AZDA114

# 3. Socket Sets & Accessories



A13316

## 3/8" DR SOCKET SET DEEP 8PC

A13316

Code	Size (mm)	Code	Size (mm)	Code	Size (mm)
A14450	10	A14453	13	A14457	17
A14451	11	A14454	14	A14459	19
A14452	12	A14455	15	-	-

Metric set. Packaged in a vacuum formed insert in a metal storage case. EVA schematic diagram with all contents listed in the lid. Vacuum formed insert printed with socket sizes and details.



A13315

## 3/8" DR SOCKET SET DEEP 8PC

A13315

Code	Size (inch)	Code	Size (inch)	Code	Size (inch)
A14435	3/8	A14438	9/16	A14441	3/4
A14436	7/16	A14439	5/8	A14442	13/16
A14437	1/2	A14440	11/16	-	-

AF set. Packaged in a vacuum formed insert in a metal storage case. EVA schematic diagram with all contents listed in the lid.



A13258

## 3/8" DR SOCKET SET 35PC

A13258

Code	Size	Code	Size	Code	Size
A14348	8mm	A14361	21mm	NH38	Ratchet
A14349	9mm	A14362	22mm	KC323	75mm Ext
A14350	10mm	A14330	1/4"	KC326	150mm Ext
A14351	11mm	A14331	5/16"	AKC300	Uni Joint
A14352	12mm	A14332	3/8"	AKC3814	3/8"to1/4" Ad
A14353	13mm	A14333	7/16"	AKC3812	3/8"to1/2" Ad
A14354	14mm	A14334	1/2"	AKC302	225mm Flex
A14355	15mm	A14335	9/16"	AKC303	5/8" Spark
A14356	16mm	A14336	5/8"	AKC304	13/16" Spark
A14357	17mm	A14337	11/16"	-	-
A14358	18mm	A14338	3/4"	-	-
A14359	19mm	A14339	13/16"	-	-
A14360	20mm	A14340	7/8"	-	-

Metric & AF set. Packaged in a vacuum formed insert in a metal storage case. EVA schematic diagram with all contents listed in the lid. Vacuum formed insert printed with socket sizes and details.



A14346-A14362

## 3/8" DR SOCKETS METRIC

A14346-A14362

Standards:			DIN 3124	
Code	Size (mm)	Weight (grams)	Diameter (mm)	Length (mm)
A14346	6	21	9	28
A14347	7	21	10	28
A14348	8	24	11	28
A14349	9	24	13	28
A14350	10	24	14	28
A14351	11	24	15	28
A14352	12	24	17	28
A14353	13	32	18	28
A14354	14	44	20	30
A14355	15	40	22	30
A14356	16	60	22	30
A14357	17	74	24	30
A14358	18	70	24	30
A14359	19	88	26	30
A14360	20	63	28	30
A14361	21	56	28	30
A14362	22	71	30	32

Single hex sockets.



**3/8" DR SOCKETS DEEP METRIC**

A14448-A14462

Standards:			DIN 899E	
Code	Size (mm)	Weight (grams)	Diameter (mm)	Length (mm)
A14448	8	50	12	63
A14449	9	52	13	63
A14450	10	56	17	63
A14451	11	60	17	63
A14452	12	63	17	63
A14453	13	65	18	63
A14454	14	75	19	63
A14455	15	80	20	63
A14456	16	92	21	63
A14457	17	100	22	63
A14458	18	114	23	63
A14459	19	150	24	63
A14460	20	155	28	63
A14461	21	152	28	63
A14462	22	173	30	63

Double hex deep sockets.



A14448-A14462

**3/8" DR SOCKETS AF**

A14330-A14340

Standards:			DIN 3124	
Code	Size (inch)	Weight (grams)	Diameter (mm)	Length (mm)
A14330	1/4	24	10	28
A14331	5/16	24	12	28
A14332	3/8	24	14	28
A14333	7/16	24	16	28
A14334	1/2	32	17	28
A14335	9/16	46	20	30
A14336	5/8	37	22	30
A14337	11/16	74	24	30
A14338	3/4	88	26	30
A14339	13/16	83	28	36
A14340	7/8	91	30	36

Single hex sockets.



A14330-A14340

**3/8" DR SOCKETS DEEP AF**

A14434-A14442

Standards:			DIN 899E	
Code	Size (inch)	Weight (grams)	Diameter (mm)	Length (mm)
A14435	1/2	54	17	63
A14435	3/8	55	17	63
A14436	7/16	56	17	63
A14437	1/2	65	19	63
A14438	9/16	75	20	63
A14439	5/8	85	22	63
A14440	11/16	105	24	63
A14441	3/4	150	26	63
A14442	13/16	180	28	63

Double hex deep sockets.



A14334-A14442

# 3. Socket Sets & Accessories



10191

## 3/8" DR SOCKET SET IN-HEX 6PC

10191

Code	Size (mm)	Code	Size (mm)	Code	Size (mm)
13504	4	13506	6	13508	8
13505	5	13507	7	13510	10

Metric set.



13504-13510

## 3/8" DR SOCKETS IN-HEX METRIC

13504-13510

Code	Size (mm)	Weight (grams)	Length (mm)
13504	4	38	50
13505	5	39	50
13506	6	40	50
13507	7	44	50
13508	8	45	50
13510	10	53	50



10190

## 3/8" DR SOCKET SET IN-HEX 6PC

10190

Code	Size (inch)	Code	Size (inch)	Code	Size (inch)
13512	1/8	13516	1/4	13520	3/8
13514	3/16	13518	5/16	13522	7/16

AF set.



13512-13555

## 3/8" DR SOCKETS IN-HEX AF

13512-13522

Code	Size (inch)	Weight (grams)	Length (mm)
13512	1/8	38	50
13514	3/16	39	50
13516	1/4	40	50
13518	5/16	44	50
13520	3/8	45	50
13522	7/16	53	50



BSK4-16T

## 3/8" DR BIT & E SOCKET SET 17PC



Code	Size	Code	Size	Code	Size
Bit	T10	Bit	T45	Socket	E10
Bit	T15	Bit	T50	Socket	E12
Bit	T20	Bit	T55	Socket	E14
Bit	T25	Socket	E6	Socket	E16
Bit	T30	Socket	E7	Adaptor	3/8" x 15/16"
Bit	T40	Socket	E8	-	-

Packaged in a vacuum formed insert in a metal case.



**ALTERNATIVE**  
Page No. 275



## 3/8" DR BANJO RATCHET

NH36

Standards:		DIN 3122			
Code	Description	Weight (grams)	Length (mm)	Torque (Nm)	Teeth
NH36	Flex Head Stubby	450	156	202	72

Auto-eject. Repair kit and spare parts available. CR-V. 44 to 46 HRC.



NH36

## 3/8" DR BANJO RATCHET

NH37

Standards:		DIN 3122			
Code	Description	Weight (grams)	Length (mm)	Torque (Nm)	Teeth
NH37	Flex Head Standard	430	262	202	72

Auto-eject. Repair kit and spare parts available. CR-V. 44 to 46 HRC.



NH37

## 3/8" DR BANJO RATCHET

NH38

Standards:		DIN 3122			
Code	Description	Weight (grams)	Length (mm)	Torque (Nm)	Teeth
NH38	Standard	330	200	262	45

Auto-eject. Repair kit and spare parts available. CR-V. 44 to 46 HRC. Exceeds DIN standard 3122 - 202Nm by a minimum of 25%.



NH38

## 3/8" DR BANJO RATCHET

NH40

Standards:		DIN 3122			
Code	Description	Weight (grams)	Length (mm)	Torque (Nm)	Teeth
NH40	Flex Head Bent	430	260	202	72

Auto-eject. Repair kit and spare parts available. CR-V. 44 to 46 HRC.



NH40

## 3/8" DR SLIDING T HANDLE

AKC305

Standards:		DIN 3124	
Code	Description	Weight (grams)	Length (mm)
AKC305	Sliding T Handle	190	165



AKC305

## 3/8" DR FLEX HEAD BAR

AKC302

Standards:		DIN 3124	
Code	Description	Weight (grams)	Length (mm)
AKC302	Flex Head Bar	260	225

Spare head and pin available.



AKC302

## 3/8" DR EXTENSIONS BAR

A14323-AKC326R

Standards:		DIN 3124	
Code	Description	Weight (grams)	Length (mm)
A14323	Extension Bar	75	75
AKC326R	Extension Bar	143	150

Round head.



A14323 - AKC326R

# 3. Socket Sets & Accessories



KC310-KC326

## 3/8" DR HEX HEAD EXTENSIONS

KC310-KC326

Standards:		DIN 3120	ANSI B107.2-1975
Code	Description	Weight (grams)	Length (mm)
KC322	Extension Bar	55	45
KC323	Extension Bar	84	75
KC326	Extension Bar	155	150
KC310	Extension Bar	240	250
KC315	Extension Bar	346	375
KC320	Extension Bar	455	500



WB305-WB365

## 3/8" DR WOBBLE EXTENSIONS

WB305-WB365

Standards:		DIN 3120	ANSI B107.2-1975
Code	Description	Weight (grams)	Length (mm)
WB305	Wobble Ext. Bar	70	75
WB307	Wobble Ext. Bar	125	150
WB309	Wobble Ext. Bar	187	250
WB316	Wobble Ext. Bar	212	300
WB365	Wobble Ext. Bar	313	450



10162A-10162D

## 3/8" DR EXTRA LONG EXTENSIONS

10162

Code	Description	Length (mm)
10162	3/8" Drive Extra Long Extensions 4PC	380, 460, 610, 760mm
Code	Weight (grams)	Length (mm)
10162A	350	380
10162B	410	460
10162C	544	610
10162D	658	760



AKC300

## 3/8" DR UNIVERSAL JOINT

AKC300

Standards:		DIN 3124		
Code	Size (inch)	Weight (grams)	Diameater (mm)	Length (mm)
AKC300	3/8	48	19	68



AKC3814

AKC3812

## 3/8" DR ADAPTORS

AKC3814-AKC3812

Standards:		DIN 3124		
Code	Description	Weight (grams)	Diameater (mm)	Length (mm)
AKC3814	3/8" F to 1/4" M	25	19	28
AKC3812	3/8" F to 1/2" M	50	19	35



AKC303-AKC304

## 3/8" DR SPARK PLUG SOCKETS

AKC303-AKC304

Standards:		DIN 3124		
Code	Size (inch)	Weight (grams)	Diameater (mm)	Length (mm)
AKC303	5/8	92	22	63
AKC304	13/16	130	28	63



ZDA28

## 3/8" DR SPARK PLUG SOCKET

ZDA28

Standards:		DIN 3120	ANSI B107.2-1975	
Code	Description	Weight (grams)	Diameater (mm)	Length (mm)
ZDA28	5/8" Angle Drive	154	23	98



A13378

## 3/8" DR RATCHET ADAPTOR

A13378

Code	Description	Weight (grams)	Length (mm)	Torque (kg-m)	Teeth
A13378	Ratchet	110	51.4	32	24

Made from CR-MO to a hardness of HRC 48.



**MULTIPLE DRIVE SOCKET SET 45PC**

A13330

Code	Size	Code	Size	Code	Size
<b>1/4" Drive:</b>					
A14420	4mm	A14429	11mm	A14412-5	11/32"
A14422	5mm	A14430	12mm	A14413	3/8"
A14424	6mm	A14410	3/16"	A14414	7/16"
A14425	7mm	A14410-5	7/32"	A14415	1/2"
A14426	8mm	A14411	1/4"	A14721	Spinner Hand
A14427	9mm	A14411-5	9/32"	AKC403	50mm Ext
A14428	10mm	A14412	5/16"	AKC406	150mm Ext
<b>3/8" Drive:</b>					
A14348	8mm	A14356	16mm	A14336	5/8"
A14349	9mm	A14357	17mm	A14337	11/16"
A14350	10mm	A14358	18mm	A14338	3/4"
A14351	11mm	A14359	19mm	NH38	Ratchet
A14352	12mm	A14332	3/8"	KC323	75mm Ext
A14353	13mm	A14333	7/16"	KC326	150mm Ext
A14354	14mm	A14434	1/2"	AKC3814	Adaptor
A14355	15mm	A14435	9/16"	AKC303	5/8" Spark



A13330

Packaged in a vacuum formed insert in a metal storage case.

**MULTIPLE DRIVE SOCKET SET 11PC**

Size	Size	Size
<b>3/8" Drive:</b>		
T10	T27	T50
T15	T30	T55
T20	T40	T60
T25	T45	-



BSK3-11TT



Tamperproof sockets. Socket rail included.

**ALTERNATIVE**  
Page No. 273

**3/8" DR E SOCKET SET 8PC**

Size	Size	Size
<b>3/8" Drive:</b>		
E6	E10	E14
E7	E11	E16
E8	E12	-



SSK3-08E



Socket rail included.

**ALTERNATIVE**  
Page No. 272

**POWER TOOL ADAPTOR SET 3PC**

10355

Code	Drive	Length (mm)	Torque (kg/cm)	Total Weight (grams)
10355	1/4, 3/8, 1/2"	65, 66 & 73	20	115

Made out of CR-V with a hardness of HRC 38-42 degree. 6.35mm Hexagon shank. Designed for use with power or cordless drills. Enables sockets to be attached to drill for fast application of bolts, nuts etc.



10355

# 3. Socket Sets & Accessories



A13173

## 1/2" DR SOCKET SET 33PC

A13173



Code	Size	Code	Size	Code	Size
AKC238	8mm	AKC249	19mm	AKC262	32mm
AKC239	9mm	AKC250	20mm	NH9	Ratchet
AKC240	10mm	AKC251	21mm	AZDA23	75mm Ext
AKC241	11mm	AKC252	22mm	AZDA25	125mm Ext
AKC242	12mm	AKC253	23mm	AZDA210	250mm Ext
AKC243	13mm	AKC254	24mm	AZDA315	375mm Flex
AKC244	14mm	AKC256	26mm	AZDA10	Uni Joint
AKC245	15mm	AKC257	27mm	AKC1238	1/2" to 3/8" Ad
AKC246	16mm	AKC258	28mm	AKC3812	3/8" to 1/2" Ad
AKC247	17mm	AKC259	29mm	AZDA26	13/16" Spark
AKC248	18mm	AKC260	30mm	AZDA26D	5/8" Spark

Metric set. Packaged in a vacuum formed insert in a metal storage case.



A13170

## 1/2" DR SOCKET SET 43PC

A13170



Code	Size	Code	Size	Code	Size
AKC238	8mm	AKC253	23mm	AKC226	1"
AKC239	9mm	AKC254	24mm	AKC227	1-1/16"
AKC240	10mm	AKC257	27mm	AKC228	1-1/8"
AKC241	11mm	AKC260	30mm	AKC230	1-1/4"
AKC242	12mm	AKC262	32mm	NH9	Ratchet
AKC243	13mm	AKC212	3/8"	AZDA23	75mm Ext
AKC244	14mm	AKC213	7/16"	AZDA25	125mm Ext
AKC245	15mm	AKC214	1/2"	ZDA410	Sliding T Bar
AKC246	16mm	AKC215	9/16"	AZDA315	375mm Flex
AKC247	17mm	AKC217	5/8"	AZDA10	Uni Joint
AKC248	18mm	AKC219	11/16"	AKC1238	1/2" to 3/8" Ad
AKC249	19mm	AKC220	3/4"	AZDA26	13/16" Spark
AKC250	20mm	AKC222	13/16"	AZDA26D	5/8" Spark
AKC251	21mm	AKC223	7/8"	-	-
AKC252	22mm	AKC224	15/16"	-	-

Metric & AF set. Packaged in a vacuum formed insert in a metal storage case.



A13695

## 1/2" DR SOCKET SET DEEP 12PC

A13695

Code	Size (mm)	Code	Size (mm)	Code	Size (mm)
A13810	10	A13814	14	A13818	18
A13811	11	A13815	15	A13819	19
A13812	12	A13816	16	A13821	21
A13813	13	A13817	17	A13822	22

Metric set. Packaged in a vacuum formed insert in a metal storage case.



A13694

## 1/2" DR SOCKET SET DEEP 10PC

A13694

Code	Size (inch)	Code	Size (inch)	Code	Size (inch)
A13798	3/8	A13802	5/8	A13806	7/8
A13799	7/16	A13803	11/16	A13807	15/16
A13800	1/2	A13804	3/4	-	-
A13801	9/16	A13805	13/16	-	-

AF set. Packaged in a vacuum formed insert in a metal storage case.



## 1/2" DR SOCKETS METRIC

AKC238-AKC262

Standards:			DIN 3124	
Code	Size (mm)	Weight (grams)	Diameter (mm)	Length (mm)
AKC238	8	44	12	38
AKC239	9	44	13	38
AKC240	10	46	15	38
AKC241	11	46	16	38
AKC242	12	48	17	38
AKC243	13	50	18	38
AKC244	14	52	20	38
AKC245	15	56	21	38
AKC246	16	56	22	38
AKC247	17	72	24	38
AKC248	18	72	26	38
AKC249	19	72	27	38
AKC250	20	76	28	38
AKC251	21	82	29	38
AKC252	22	86	30	38
AKC253	23	100	32	40
AKC254	24	112	32	40
AKC255	25	125	34	42
AKC256	26	138	36	42
AKC257	27	168	36	43
AKC258	28	178	38	43
AKC259	29	192	38	43
AKC260	30	206	40	43
AKC262	32	230	42	43



AKC238-AKC262

Double hex sockets.

## 1/2" DR SOCKETS DEEP METRIC

A13808-A13822

Standards:			DIN 899E	TUV
Code	Size (mm)	Weight (grams)	Diameter (mm)	Length (mm)
A13808	8	114	22	78
A13809	9	145	22	78
A13810	10	110	22	78
A13811	11	110	22	78
A13812	12	110	22	78
A13813	13	110	22	78
A13814	14	110	22	78
A13815	15	110	22	78
A13816	16	110	22	78
A13817	17	135	22	78
A13818	18	160	22	78
A13819	19	160	24	78
A13821	21	188	25	78
A13822	22	220	25	78



A13808-A13822

Double hex deep sockets.

## 1/2" DR SOCKETS AF

AKC212-AKC230

Standards:			DIN 3124	
Code	Size (inch)	Weight (grams)	Diameter (mm)	Length (mm)
AKC212	3/8	46	14	38
AKC213	7/16	46	16	38
AKC214	1/2	50	18	38
AKC215	9/16	52	20	38
AKC217	5/8	56	22	38
AKC219	11/16	72	24	38
AKC220	3/4	72	27	38
AKC222	13/16	76	28	38
AKC223	7/8	86	30	38
AKC224	15/16	100	32	40
AKC226	1	125	34	42
AKC227	1-1/16	168	36	43
AKC228	1-1/8	192	38	43
AKC229	1-3/16	206	40	45
AKC230	1-1/4	230	42	45



AKC212-AKC230

Double hex sockets.

# 3. Socket Sets & Accessories



A13798-A13807

## 1/2" DR SOCKETS DEEP AF

A13798-A13807

Standards:		DIN 899E		TUV
Code	Size (inch)	Weight (grams)	Diameter (mm)	Length (mm)
A13798	3/8	110	22	78
A13799	7/16	110	22	78
A13800	1/2	110	22	78
A13801	9/16	120	22	78
A13802	5/8	120	22	78
A13803	11/16	135	24	78
A13804	3/4	160	24	78
A13805	13/16	188	25	78
A13806	7/8	220	25	78
A13807	15/16	250	26	78

Double hex deep sockets.



13669

## 1/2" DR SOCKET SET IN-HEX 10PC

13669

Standards:		DIN 3124			
Code	Size (mm)	Code	Size (mm)	Code	Size (mm)
13680	4	13684	8	13688	17
13681	5	13685	10	13689	19
13682	6	13686	12	-	-
13683	7	13687	14	-	-

Metric set. Packaged in a plastic case with a vacuum formed insert.



13668

## 1/2" DR SOCKET SET IN-HEX 10PC

13668

Standards:		DIN 3124			
Code	Size (inch)	Code	Size (inch)	Code	Size (inch)
13670	5/32	13674	5/16	13678	5/8
13671	3/16	13675	3/8	13679	3/4
13672	7/32	13676	1/2	-	-
13673	1/4	13677	9/16	-	-

AF set. Packaged in a plastic case with a vacuum formed insert.



13680-13689

## 1/2" DR SOCKETS IN-HEX METRIC

13680-13689

Standards:		DIN 3124		
Code	Size (mm)	Weight (grams)	Depth (mm)	Length (mm)
13680	4	65	13	55
13681	5	65	13	55
13682	6	65	13	55
13683	7	70	15	55
13684	8	70	15	55
13685	10	94	18	55
13686	12	102	22	55
13687	14	166	26	65
13688	17	212	28	70
13689	19	252	30	70



**1/2" DR SOCKETS IN-HEX AF**

13670-13679

Standards:		DIN 3124		
Code	Size (inch)	Weight (grams)	Depth (mm)	Length (mm)
13670	5/32	65	13	55
13671	3/16	65	13	55
13672	7/32	65	13	55
13673	1/4	65	13	55
13674	5/16	65	15	55
13675	3/8	92	18	55
13676	1/2	102	22	55
13677	9/16	166	26	65
13678	5/8	212	28	65
13679	3/4	252	30	70



13670-13679

**1/2" DR E SOCKET SET 9PC**

SSK4-09E

Size	Size	Size
E10	E14	E20
E11	E16	E22
E12	E18	E24

Socket rail included.



SSK4-09E

**1/2" DR E SOCKETS**

SS4-E

Code	Size	Weight (grams)	Diameter (mm)	Length (mm)
SS4-08E	E8	47	13	38
SS4-10E	E10	49	14	38
SS4-11E	E11	47	15	38
SS4-12E	E12	49	16	38
SS4-14E	E14	51	18	38
SS4-16E	E16	54	20	38
SS4-18E	E18	68	24	38
SS4-20E	E20	81	26	38
SS4-22E	E22	96	28	38
SS4-24E	E24	96	28	38



13421-13429



# 3. Socket Sets & Accessories



NH9

## 1/2" DR BANJO RATCHET

NH9

Standards:			DIN 3122		
Code	Description	Weight (grams)	Length (mm)	Torque (Nm)	Teeth
NH9	Standard	590	255	665	45

Auto-eject. Repair kit and spare parts available. Exceeds same DIN standard 3122 - 512Nm by a minimum of 25%.



NH13

## 1/2" DR BANJO RATCHET

NH13

Standards:			DIN 3122		
Code	Description	Weight (grams)	Length (mm)	Torque (Nm)	Teeth
NH13	Standard	620	254	512	72

Auto-eject. Repair kit and spare parts available.



NH10

## 1/2" DR BANJO RATCHET

NH10

Standards:			DIN 3122		
Code	Description	Weight (grams)	Length (mm)	Torque (Nm)	Teeth
NH10	Flex Head Stubby	550	193	512	72

Auto-eject. Repair kit and spare parts available.



NH11

## 1/2" DR BANJO RATCHET

NH11

Standards:			DIN 3122		
Code	Description	Weight (grams)	Length (mm)	Torque (Nm)	Teeth
NH11	Flex Head Straight	720	275	512	72

Auto-eject. Repair kit and spare parts available. CR-V. 44 to 46 HRC.



ZDA410

## 1/2" DR SLIDING T HANDLE

ZDA410

Code	Weight (grams)	Length (mm)
ZDA410	495	250



AZDA315

## 1/2" DR FLEX HEAD BAR

AZDA315-AZDA317

Code	Description	Weight (grams)	Length (mm)
AZDA315	Flex Head Bar	705	375
AZDA317	Flex Head Bar	1400	600

Repair kits available.



AZDA317



A13379

## 1/2" DR BREAKER BAR

A13379

Code	Description	Weight (grams)	Length (mm)
A13379	Breaker Bar	1620	670

Repair kits available.



ZDA518

## 1/2" DR SPEED BRACE

ZDA518

Code	Description	Weight (grams)	Length (mm)
ZDA518	Speed Brace	600	420

Repair kits available.



## 1/2" DR EXTENSIONS

AZDA23-AZDA210

Standards:		DIN 3124	
Code	Description	Weight (grams)	Length (mm)
AZDA23	Extension Bar	136	75
AZDA25	Extension Bar	219	125
AZDA210	Extension Bar	427	250

Round head.



AZDA23-AZDA210

## 1/2" DR EXTENSIONS

ZDA16-ZDA20

Standards:		DIN 3120	ANSI B107.2-1975
Code		Weight (grams)	Length (mm)
ZDA16		102	50
ZDA17		220	125
ZDA18		250	250
ZDA19		615	375
ZDA20		810	500

Hex head.



ZDA16-ZDA20

## 1/2" DR WOBBLE EXTENSIONS

WB32-WB36

Standards:		DIN 3120	ANSI B107.2-1975
Code		Weight (grams)	Length (mm)
WB32		176	125
WB34		310	250
WB36		575	500



WB32-WB36

## 1/2" DR EXTRA LONG EXTENSION SET 4PC

10166

Code	Description	Weight (grams)	Length (mm)
10166	4 Piece Set	535 - 1067	380, 460, 610 & 760



10166

## 1/2" DR EXTRA LONG EXTENSIONS

10166A-10166D

Code		Weight (grams)	Length (mm)
10166A		535	380
10166B		640	460
10166C		845	610
10166D		1067	760



10166A-10166D

## 1/2" DR UNIVERSAL JOINT

AZDA10

Standards:		DIN 3124	
Code	Size (inch)	Weight (grams)	Length (mm)
AZDA10	1/2	140	80



AZDA10

# 3. Socket Sets & Accessories



AKC1238

KC1234

## 1/2" DR ADAPTORS

AKC1238-KC1234

Standards:		ANSI	
Code	Description	Weight (grams)	Length (mm)
AKC1238	1/2" F to 3/8" M	66	36
KC1234	1/2" F to 3/4" M	120	50



AZDA26-AZDA26D



ZDA29-ZDA30

## 1/2" DR SPARK PLUG SOCKETS

AZDA26-ZDA30

Standards:		DIN 3124		
Code	Description	Weight (grams)	Diameter (mm)	Length (mm)
AZDA26	13/16"	142	28	65
AZDA26D	5/8"	88	22	65
ZDA29	5/8" Magnetic	94	22	65
ZDA30	13/16" Magnetic	141	28	65



ZDA27

## 1/2" DR SPARK PLUG SOCKETS

ZDA27

Standards:		DIN 3120	ANSI B107.2-1975	
Code	Description	Weight (grams)	Diameter (mm)	Length (mm)
ZDA27	5/8" Angle Drive	140	22	98



A13377

## 1/2" DR RATCHET ADAPTOR

A13377

Code	Description	Weight (grams)	Length (mm)	Torque (kg-m)	Teeth
A13377	Ratchet Adaptor	200	62.5	70	24

Made from CR-MO to a hardness of HRC 48.



10198

## SOCKET HOLDER SET 3PC

10198

Code	Range	Length (mm)
10198	1/4", 3/8" & 1/2" Drive	410

3 screw holes for surface mounting. Adjustable sliding rail socket holder clips. Steel plated.



10195-10197

## SOCKET HOLDERS

10195-10197

Code	Range	Length (mm)	Number Of Sockets
10195	1/4" Drive	410	15
10196	3/8" Drive	410	15
10197	1/2" Drive	410	15

3 screw holes for surface mounting. Adjustable sliding rail socket holder clips. Steel plated.



**3/4" DR SOCKET SET 26PC**

A13362

Code	Size	Code	Size	Code	Size
AKC142	22mm	AKC168	50mm	AKC124	1-5/8"
AKC144	24mm	AKC114	1"	AKC126	1-3/4"
AKC147	27mm	AKC115	1-1/16"	AKC128	1-7/8"
AKC150	30mm	AKC116	1-1/8"	AKC130	2"
AKC152	32mm	AKC117	1-3/16"	H34	Ratchet
AKC156	36mm	AKC119	1-5/16"	KC100	460mm T Bar
AKC157	38mm	AKC120	1-3/8"	KC103	100mm Ext
AKC161	41mm	AKC121	1-7/16"	KC105	200mm Ext
AKC164	46mm	AKC122	1-1/2"	-	-

Metric and AF set. Packaged in a metal storage case.



A13362

**3/4" DR SOCKET SET 23PC**

A13365

Code	Size	Code	Size	Code	Size
AKC139	19mm	AKC148	28mm	AKC161	41mm
AKC141	21mm	AKC149	29mm	AKC164	46mm
AKC142	22mm	AKC150	30mm	AKC168	50mm
AKC143	23mm	AKC152	32mm	H34	Ratchet
AKC144	24mm	AKC153	33mm	KC100	460mm T Bar
AKC145	25mm	AKC155	35mm	KC103	100mm Ext
AKC146	26mm	AKC156	36mm	KC105	200mm Ext
AKC147	27mm	AKC157	38mm	-	-

Metric set. Packaged in a metal storage case.



A13365

**3/4" DR SOCKET SET 24PC**

A13363

Code	Size	Code	Size	Code	Size
AKC110	3/4"	AKC118	1-1/4"	AKC126	1-3/4"
AKC111	13/16"	AKC119	1-5/16"	AKC127	1-13/16"
AKC112	7/8"	AKC120	1-3/8"	AKC128	1-7/8"
AKC113	15/16"	AKC121	1-7/16"	AKC130	2"
AKC114	1"	AKC122	1-1/2"	H34	Ratchet
AKC115	1-1/16"	AKC123	1-9/16"	KC100	460mm T Bar
AKC116	1-1/8"	AKC124	1-5/8"	KC103	100mm Ext
AKC117	1-3/16"	AKC125	1-11/16"	KC105	200mm Ext

AF set. Packaged in a metal storage case.



A13363



# 3. Socket Sets & Accessories



AKC139-AKC177

## 3/4" DR SOCKETS METRIC

AKC139-AKC177

Code	Size (mm)	Weight (grams)	Diameter (mm)	Length (mm)
AKC139	19	160	29	50
AKC141	21	180	31	50
AKC142	22	210	32	50
AKC143	23	210	33	50
AKC144	24	220	34	51
AKC145	25	220	36	52
AKC146	26	230	37	52
AKC147	27	230	38	52
AKC148	28	240	39	52
AKC149	29	250	40	52
AKC150	30	270	42	54
AKC152	32	290	44	56
AKC153	33	320	46	56
AKC155	35	370	48	58
AKC156	36	400	50	58
AKC157	38	470	52	60
AKC161	41	540	56	64
AKC164	46	650	62	68
AKC168	50	800	68	72
AKC172	55	900	74	76
AKC177	60	1050	80	78

Double hex sockets.



AKC110-AKC138

## 3/4" DR SOCKETS AF

AKC110-AKC138

Code	Size (inch)	Weight (grams)	Diameter (mm)	Length (mm)
AKC110	3/4	160	29	50
AKC111	13/16	180	31	50
AKC112	7/8	210	32	50
AKC113	15/16	220	34	51
AKC114	1	220	37	52
AKC115	1-1/16	220	38	52
AKC116	1-1/8	240	40	52
AKC117	1-3/16	260	42	54
AKC118	1-1/4	290	44	56
AKC119	1-5/16	320	46	56
AKC120	1-3/8	370	48	58
AKC121	1-7/16	400	50	58
AKC122	1-1/2	470	52	60
AKC123	1-9/16	510	54	62
AKC124	1-5/8	540	56	64
AKC125	1-11/16	580	58	65
AKC126	1-3/4	620	60	66
AKC127	1-13/16	650	62	68
AKC128	1-7/8	740	64	70
AKC129	1-15/16	770	66	70
AKC130	2	800	68	72
AKC131	2-1/16	820	70	72
AKC132	2-1/8	850	72	74
AKC133	2-3/16	900	74	76
AKC134	2-1/4	950	76	76
AKC135	2-5/16	1000	78	78
AKC136	2-3/8	1050	80	78
AKC137	2-7/16	1150	82	80
AKC138	2-1/2	1200	84	82

Double hex sockets.



## 3/4" DR BANJO RATCHET

H34

Standards:		ANSI B107.10M			
Code	Description	Weight (grams)	Length (mm)	Torque (Nm)	Teeth
H34	Standard	2600	500	2118	24

Repair kit and spare parts available. Exceeds DIN standard 3122 - 1412Nm.



H34

## 3/4" DR SLIDING T HANDLE

KC100

Code	Description	Weight (grams)	Length (mm)
KC100	Sliding T Handle	1370	460



KC100

## 3/4" DR FLEX HEAD BAR

KC101

Code	Description	Length (mm)
KC101	Flex Head Bar	475



KC101

## 3/4" DR FLEX HEAD BAR

KC1000

Code	Description	Length (mm)
KC1000	Flex Head Bar	1000

Repair kit available. Handle is made from CR-V. Head is made from CR-MO.



KC1000

## 3/4" DR L HANDLE

KC102

Code	Description	Weight (grams)	Length (mm)
KC102	L Handle	1975	450



KC102

## 3/4" DR EXTENSIONS

KC103-KC106

Code	Weight (grams)	Length (mm)
KC103	402	100
KC104	502	125
KC105	560	200
KC106	1320	400



KC103-KC106

# 3. Socket Sets & Accessories



KC108

## 3/4" DR UNIVERSAL JOINT

KC108

Code	Size (inch)	Weight (grams)	Length (mm)
KC108	3/4	600	110



KC3412



KC3410

## 3/4" DR ADAPTORS

KC3410-KC3412

Code	Description	Weight (grams)	Diameter (mm)	Length (mm)
KC3412	3/4" F to 1/2" M	200	34	52
KC3410	3/4" F to 1" M	340	38	62



10966-10996

## TRUCK WHEEL LOCKNUT SOCKETS

10966-10996

Code	Drive	SIZE
10966	1/2"	54mm
10968	1/2"	55mm
10970	3/4"	2-1/4"
10972	3/4"	2-1/2"
10974	3/4"	2-5/8"
10976	3/4"	2-7/8"
10978	3/4"	3-1/8"
10980	3/4"	3-1/4" 8 Point
10982	3/4"	3-1/2"
10984	3/4"	3-3/4" 8 Point
10986	3/4"	3-13/16" 8 Point
10988	3/4"	3-7/8" 8 Point
10990	3/4"	4"
10992	3/4"	4-1/8"
10994	3/4"	4-13/16" 8 Point
10996	3/4"	4-7/8" 8 Point

Truck wheel bearing locknut sockets.



10911-10914



**SUPERSEDED**  
Part No. STDS

## T-HANDLE SOCKET WRENCHES

10910-10914

Code	Size (mm)	Description	Weight (grams)	Length (mm)
10910	8	T-Handle Socket Wrench	312	250
10911	10	T-Handle Socket Wrench	415	250
10912	12	T-Handle Socket Wrench	420	250
10913	13	T-Handle Socket Wrench	425	300
10914	14	T-Handle Socket Wrench	430	300



**1" DR SOCKET SET 22PC**

A13366

Code	Size	Code	Size	Code	Size
AKC519	35mm	AKC527	58mm	AKC535	77mm
AKC520	36mm	AKC528	60mm	AKC536	80mm
AKC521	38mm	AKC529	63mm	AH18	Ratchet
AKC522	41mm	AKC530	65mm	AKC540	560mm T Bar
AKC523	46mm	AKC531	67mm	AKC541	200mm Ext
AKC524	50mm	AKC532	70mm	AKC542	400mm Ext
AKC525	54mm	AKC533	71mm	-	-
AKC526	55mm	AKC534	75mm	-	-

Metric set. Packaged in a metal storage case.



A13366

**1" DR SOCKET SET 22PC**

A13367

Code	Size	Code	Size	Code	Size
AKC501	1-1/2"	AKC509	2-3/16"	AKC517	3"
AKC502	1-5/8"	AKC510	2-1/4"	AKC518	3-1/8"
AKC503	1-11/16"	AKC511	2-3/8"	AH18	Ratchet
AKC504	1-3/4"	AKC512	2-7/16"	AKC540	560mm T Bar
AKC505	1-13/16"	AKC513	2-1/2"	AKC541	200mm Ext
AKC506	1-7/8"	AKC514	2-5/8"	AKC542	400mm Ext
AKC507	2"	AKC515	2-3/4"	-	-
AKC508	2-1/8"	AKC516	2-15/16"	-	-

AF set. Packaged in a metal storage case.



A13367

**1" DR SOCKETS METRIC**

AKC519-AKC536

Code	Size (mm)	Weight (grams)	Depth (mm)	Length (mm)
AKC519	35	430	48	61
AKC520	36	460	51	65
AKC521	38	485	54	65
AKC522	41	560	57	70
AKC523	46	830	65	75
AKC524	50	1035	70	75
AKC525	54	1150	74	80
AKC526	55	1180	76	80
AKC527	58	1285	79	80
AKC528	60	1370	82	84
AKC529	63	1500	86	87
AKC530	65	1570	88	87
AKC531	67	1640	90	90
AKC532	70	2000	94	93
AKC533	71	2100	95	93
AKC534	75	2350	100	97
AKC535	77	2500	102	103
AKC536	80	2600	105	103

Double hex sockets.



AKC519-AKC536

# 3. Socket Sets & Accessories



AKC501-AKC518

## 1" DR SOCKETS AF

AKC501-AKC518

Code	Size (inch)	Weight (grams)	Depth (mm)	Length (mm)
AKC501	1-1/2	500	54	65
AKC502	1-5/8	550	57	70
AKC503	1-11/16	690	60	70
AKC504	1-3/4	780	63	75
AKC505	1-13/16	870	65	75
AKC506	1-7/8	980	67	75
AKC507	2	1000	70	75
AKC508	2-1/8	1170	74	80
AKC509	2-3/16	1220	76	80
AKC510	2-1/4	1280	78	80
AKC511	2-3/8	1450	82	84
AKC512	2-7/16	1480	84	87
AKC513	2-1/2	1580	86	87
AKC514	2-5/8	1720	90	90
AKC515	2-3/4	2000	94	93
AKC516	2-15/16	2330	100	97
AKC517	3	2640	102	103
AKC518	3-1/8	2700	105	103

Double hex sockets.



AH18

## 1" DR BANJO RATCHET

AH18

Code	Description	Weight (grams)	Length (mm)	Torque (Nm)	Teeth
AH18	Standard Banjo Ratchet	4300	660	3260	24

Repair kit and spare parts available. Exceeds DIN standard 3122 - 2515Nm by at least 25%.



AKC540

## 1" DR SLIDING T HANDLE

AKC540

Code	Description	Weight (grams)	Length (mm)
AKC540	Sliding T Handle	2900	560



KC800

## 1" DR FLEX HEAD BAR

KC800

Code	Description	Length (mm)	Standard Torque (Nm)	Torque (Nm)
KC800	Flex Head Bar	800	1694.8	2745.96



AKC541-AKC542

## 1" DR EXTENSIONS

AKC541-AKC542

Code	Description	Weight (grams)	Length (mm)
AKC541	Extension	1316	200
AKC542	Extension	2280	400



KC1034

## 1" DR ADAPTOR

KC1034

Code	Size	Weight (grams)	Diameter (mm)	Length (mm)
KC1034	1" F to 3/4" M	410	48	70

**MULTIPLE DRIVE SOCKET SET 39PC**

10100

Size	Size	Size	Size	Size
<b>1/4" Drive:</b>				
4mm	8mm	12mm	9/32"	7/16"
5mm	9mm	3/16"	5/16"	1/2"
6mm	10mm	7/32"	11/16"	Spinner Handle
7mm	11mm	1/4"	3/8"	
<b>3/8" Drive:</b>				
9mm	13mm	19mm	9/16"	Ratchet
10mm	14mm	3/8"	5/8"	75mm Ext
11mm	16mm	7/16"	11/16"	3/8" F to 1/4" M Ad
12mm	17mm	1/2"	3/4"	5/8" Spark

Packaged in a vacuum formed insert in a metal storage case.



10100

**1/4" DR STANDARD BANJO RATCHET**

10160

Standard:		DIN3122		
Code	Weight (grams)	Length (mm)	Teeth	
10160	120	145	45	



10160

**3/8" DR STANDARD BANJO RATCHET**

10155

Standard:		DIN3122		
Code	Weight (grams)	Length (mm)	Teeth	
10155	300	190	45	



10155

**3/8" DR WOBBLE BAR SET 3PC**

10170

Standard:		DIN3122		
Code	Pieces	Weight (grams)	Length (mm)	
10170	3	378	75, 150 & 200	

Allows 15° angle, but also locks in the straight position.



10170

**1/2" DR SOCKET SET 41PC**

10120

Size (mm)	Size (mm)	Size (inch)	Size (inch)	Accessories
10	19	3/8	15/16	Ratchet
11	20	7/16	1	Flex Head
12	21	1/2	1-1/16	125mm Ex
13	22	9/16	1-1/8	250mm Ex
14	23	5/8	1-3/16	Uni Joint
15	24	11/16	1-1/4	13/16" Spark
16	27	3/4	-	5/8" Spark
17	30	13/16	-	Sliding T
18	32	7/8	-	-

Packaged in a vacuum formed insert in a metal storage case.



10120



# 3. Socket Sets & Accessories



10150

## 1/2" DR STANDARD BANJO RATCHET

10150

Standard:		DIN3122	
Code	Weight (grams)	Length (mm)	Teeth
10150	560	240	45



10179

## 1/4, 3/8 & 1/2" DR WOBBLE BAR SET 9PC

10179

Size (mm)	Size (mm)	Size (mm)
1/4" Drive:		
50	100	225
3/8" Drive:		
75	150	225
1/2" Drive:		
50	125	250

Allows 15° angle, but also locks in the straight position. Packaged in a vacuum formed insert.



10175

## 1/2" DR WOBBLE BAR SET 3PC

10175

Standard:		DIN3122	
Code	Pieces	Weight (grams)	Length (mm)
10175	3	650	75, 150 & 200

Allows 15° angle, but also locks in the straight position.



19344

## 3/4" DR SOCKET SET METRIC & AF 26PC

19344

Size (mm)	Size (mm)	Size (inch)	Size (inch)	Accessories
22	38	7/8	1-3/8	Ratchet
24	41	15/16	1-7/16	Sliding T
27	46	1	1-5/8	100mm Ext
30	50	1-1/8	1-3/4	200mm Ext
32	-	1-1/4	1-7/8	-
36	-	1-5/16	2	-

Packaged in a metal storage case.

**3/4" DR STANDARD BANJO RATCHET**

19384

Code	Weight (grams)	Length (mm)	Teeth
19384	2000	500	45

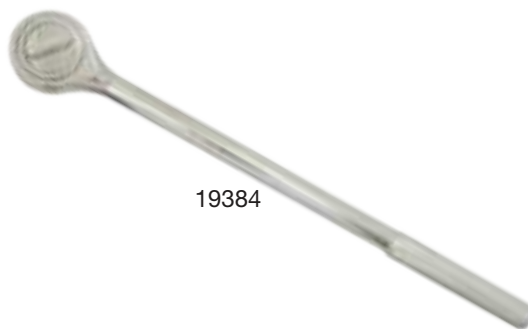

19384

**3/4" DR SLIDING T HANDLE**

19385

Code	Weight (grams)	Length (mm)
19385	1500	460



19385

**3/4" DR EXTENSION BARS**

19386-19387

Code	Weight (grams)	Length (mm)
19386	500	200
19387	409	100



19386-19387



## 4. Spanner Sets & Accessories

**The right tool,  
in the right hand.**





Stringent quality control and compliance with international standards ensure that KC Tools spanners are particularly suitable for professional and industrial applications. The range comprises of metric and imperial combination, stubby, gear ratchet, offset ring, long ring, open end, obstruction, e-type and flare nut spanners.

Our range of spanners are built tough to exceed ANSI standards and hardened to take on the toughest nuts and bolts while being easy on our hands.



# 4. Spanner Sets & Accessories



A13501

## COMBINATION SPANNER SET SHORT 7PC A13501

Code	Size (mm)	Code	Size (mm)	Code	Size (mm)
A13520	10	A13524	14	A13528	19
A13522	12	A13525	15	-	-
A13523	13	A13527	17	-	-

Metric set. Extra short highly polished CR-V combination spanners. Packaged in a vacuum formed tray.



A13500

## COMBINATION SPANNER SET SHORT 7PC A13500

Code	Size (inch)	Code	Size (inch)	Code	Size (inch)
A13510	3/8	A13513	9/16	A13516	3/4
A13511	7/16	A13514	5/8	-	-
A13512	1/2	A13515	11/16	-	-

AF set. Extra short highly polished CR-V combination spanners. Packaged in a vacuum formed tray.



A13502

## COMBINATION SPANNER SET SHORT 14PC A13502

Code	Size	Code	Size	Code	Size
A13520	10mm	A13527	17mm	A13513	9/16"
A13522	12mm	A13529	19mm	A13514	5/8"
A13523	13mm	A13510	3/8"	A13515	11/16"
A13524	14mm	A13511	7/16"	A13516	3/4"
A13525	15mm	A13512	1/2"	-	-

Metric and AF set. Extra short highly polished CR-V combination spanners. Packaged in a vacuum formed tray.



A13339

## COMBINATION SPANNER SET 8PC A13339

Standards:		ANSI B107.100.2002			
Code	Size (mm)	Code	Size (mm)	Code	Size (mm)
ACM22	22	ACM25	25	ACM32	32
ACM23	23	ACM27	27	ACM36	36
ACM24	24	ACM30	30	-	-

Metric set. Long series combination spanners. Highly polished CR-V. Packaged in a canvas pouch.



A13338

## COMBINATION SPANNER SET 8PC A13338

Standards:		ANSI B107.100.2002			
Code	Size (inch)	Code	Size (inch)	Code	Size (inch)
AC32	1	AC40	1-1/4	AC46	1-7/16
AC34	1-1/16	AC42	1-5/16	AC48	1-1/2
AC36	1-1/8	AC44	1-3/8	-	-

AF set. Long series combination spanners. Highly polished CR-V. Packaged in a canvas pouch.

**COMBINATION SPANNER SET 12PC**

A13336

Standards:		ANSI B107.100.2002			
Code	Size (mm)	Code	Size (mm)	Code	Size (mm)
ACM07TS	7	ACM11TS	11	ACM15TS	15
ACM08TS	8	ACM12TS	12	ACM17TS	17
ACM09TS	9	ACM13TS	13	ACM19TS	19
ACM10TS	10	ACM14TS	14	ACM21TS	21

Metric set. Long series combination spanners. Highly polished CR-V. Packaged in a canvas pouch.



A13336

**COMBINATION SPANNER SET 12PC**

A13334

Standards:		ANSI B107.100.2002			
Code	Size (inch)	Code	Size (inch)	Code	Size (inch)
AC8	1/4	AC16	1/2	AC24	3/4
AC10	5/16	AC18	9/16	AC26	13/16
AC12	3/8	AC20	5/8	AC28	7/8
AC14	7/16	AC22	11/16	AC30	15/16

AF set. Long series combination spanners. Highly polished CR-V. Packaged in a canvas pouch.



A13334

**COMBINATION SPANNER SET 15PC**

A13337

Standards:		ANSI B107.100.2002			
Code	Size (mm)	Code	Size (mm)	Code	Size (mm)
ACM07TS	7	ACM12TS	12	ACM17TS	17
ACM08TS	8	ACM13TS	13	ACM18TS	18
ACM09TS	9	ACM14TS	14	ACM19TS	19
ACM10TS	10	ACM15TS	15	ACM20TS	20
ACM11TS	11	ACM16TS	16	ACM21TS	21

Metric set. Long series combination spanners. Highly polished CR-V. Packaged in a canvas pouch.



A13337

**COMBINATION SPANNER SET AF 16PC**

A13342

Standards:		ANSI B107.100.2002			
Code	Size (inch)	Code	Size (inch)	Code	Size (inch)
AC8	1/4	AC20	5/8	AC32	1
AC10	5/16	AC22	11/16	AC34	1-1/16
AC12	3/8	AC24	3/4	AC36	1-1/8
AC14	7/16	AC26	13/16	AC40	1-1/4
AC16	1/2	AC28	7/8	-	-
AC18	9/16	AC30	15/16	-	-

AF set. Long series combination spanners. Highly polished CR-V. Packaged in a canvas pouch.



A13342



# 4. Spanner Sets & Accessories



A13344

## COMBINATION SPANNER SET 23PC

A13344

Standards:			ANSI B107.100.2002		
Code	Size (mm)	Code	Size (mm)	Code	Size (mm)
ACM07TS	7	ACM15TS	15	ACM23	23
ACM08TS	8	ACM16TS	16	ACM24	24
ACM09TS	9	ACM17TS	17	ACM25	25
ACM10TS	10	ACM18TS	18	ACM26	26
ACM11TS	11	ACM19TS	19	ACM27	27
ACM12TS	12	ACM20TS	20	ACM30	30
ACM13TS	13	ACM21TS	21	ACM32	32
ACM14TS	14	ACM22	22	-	-

Metric set. Long series combination spanners. Highly polished CR-V. Packaged in a canvas pouch.



A13328

## COMBINATION SPANNER SET 24PC

A13328

Standards:			ANSI B107.100.2002		
Code	Size	Code	Size	Code	Size
ACM07TS	7mm	ACM15TS	15mm	AC16	1/2"
ACM08TS	8mm	ACM17TS	17mm	AC18	9/16"
ACM09TS	9mm	ACM19TS	19mm	AC20	5/8"
ACM10TS	10mm	ACM21TS	21mm	AC22	11/16"
ACM11TS	11mm	AC8	1/4"	AC24	3/4"
ACM12TS	12mm	AC10	5/16"	AC26	13/16"
ACM13TS	13mm	AC12	3/8"	AC28	7/8"
ACM14TS	14mm	AC14	7/16"	AC30	15/16"

Metric and AF set. Long series combination spanners. Highly polished CR-V. Packaged in a canvas pouch.



A13340

## COMBINATION SPANNER SET 39PC

A13340

Standards:			ANSI B107.100.2002		
Code	Size	Code	Size	Code	Size
ACM07TS	7mm	ACM20TS	20mm	AC14	7/16"
ACM08TS	8mm	ACM21TS	21mm	AC16	1/2"
ACM09TS	9mm	ACM22	22mm	AC18	9/16"
ACM10TS	10mm	ACM23	23mm	AC20	5/8"
ACM11TS	11mm	ACM24	24mm	AC22	11/16"
ACM12TS	12mm	ACM25	25mm	AC24	3/4"
ACM13TS	13mm	ACM26	26mm	AC26	13/16"
ACM14TS	14mm	ACM27	27mm	AC28	7/8"
ACM15TS	15mm	ACM30	30mm	AC30	15/16"
ACM16TS	16mm	ACM32	32mm	AC32	1"
ACM17TS	17mm	AC8	1/4"	AC34	1-1/16"
ACM18TS	18mm	AC10	5/16"	AC36	1-1/8"
ACM19TS	19mm	AC12	3/8"	AC40	1-1/4"

Metric and AF set. Long series combination spanners. Highly polished CR-V. Packaged in a canvas pouch.



A13700

## GEAR RATCHET SPANNER SET 7PC

A13700

Code	Size (mm)	Code	Size (mm)	Code	Size (mm)
A13708	8	A13713	13	A13719	19
A13710	10	A13714	14	-	-
A13712	12	A13717	17	-	-

Metric set. Stubby reverse gear ratchet spanners. Crack nut or bolt with open end first before using gear ratchet end. Highly polished CR-V exceeds all ANSI specifications for strength. Packaged in a plastic case.

**GEAR RATCHET SPANNER SET 7PC** A13760

Code	Size (inch)	Code	Size (inch)	Code	Size (inch)
A13761	5/16	A13764	1/2	A13768	3/4
A13762	3/8	A13765	9/16	-	-
A13763	7/16	A13766	5/8	-	-

AF set. Stubby reverse gear ratchet spanners. Crack nut or bolt with open end first before using gear ratchet end. Highly polished CR-V exceeds all ANSI specifications for strength. Packaged in a plastic case.



A13760

**GEAR RATCHET SPANNER SET 7PC** A13600

Code	Size (mm)	Code	Size (mm)	Code	Size (mm)
A13608	8	A13613	13	A13619	19
A13610	10	A13614	14	-	-
A13612	12	A13617	17	-	-

Metric set. Reverse gear ratchet spanners 72 teeth. Crack nut or bolt with open end first before using gear ratchet end. Highly polished CR-V exceeds all applicable ANSI specifications for strength. Packaged in a plastic case.



A13600

**GEAR RATCHET SPANNER SET 7PC** A13750

Code	Size (inch)	Code	Size (inch)	Code	Size (inch)
A13751	5/16	A13754	1/2	A13758	3/4
A13752	3/8	A13755	9/16	-	-
A13753	7/16	A13756	5/8	-	-

AF set. Reverse gear ratchet spanners 72 teeth. Crack nut or bolt with open end first before using gear ratchet end. Highly polished CR-V exceeds all applicable ANSI specifications for strength. Packaged in a plastic case.



A13750

**GEAR RATCHET SPANNER SET 7PC** A13560

Standards:		ANSI B107.100-2002			
Code	Size (mm)	Code	Size (mm)	Code	Size (mm)
A13561	8	A13566	13	A13578	19
A13563	10	A13567	14	-	-
A13565	12	A13576	17	-	-

Metric set. One way gear ratchet spanners. 72 teeth ratchet mechanism which operates within a 5° movement. Manufactured to work at higher torque levels than most other gear wrenches due to a unique patented offset gear tooth design. Crack nut or bolt with open end before using gear ratchet end. Exceed all applicable ANSI specifications for strength. Packaged in a plastic case. Highly polished CR-V.



**ALSO SEE**  
Page No. 286



A13560

**GEAR RATCHET SPANNER SET 7PC** A13550

Standards:		ANSI B107.100-2002			
Code	Size (inch)	Code	Size (inch)	Code	Size (inch)
A13551	5/16	A13554	1/2	A13558	3/4
A13552	3/8	A13555	9/16	-	-
A13553	7/16	A13556	5/8	-	-

AF set. One way gear ratchet spanners. 72 teeth ratchet mechanism which operates within a 5° movement. Manufactured to work at higher torque levels than most other gear wrenches due to a unique patented offset gear tooth design. Crack nut or bolt with open end before using gear ratchet end. Exceed all applicable ANSI specifications for strength. Packaged in a plastic case. Highly polished CR-V.



**ALSO SEE**  
Page No. 284



A13550



# 4. Spanner Sets & Accessories



A13780

## GEAR RATCHET SPANNER SET 7PC

A13780

Code	Size (mm)	Code	Size (mm)	Code	Size (mm)
A13781	8	A13784	13	A13787	19
A13782	10	A13785	14	-	-
A13783	12	A13786	17	-	-

Metric set. Flex head one way gear ratchet spanners. Can rotate up to 180° for working in tight areas. Heads tensioned to maintain required position at all times. Highly polished CR-V exceeds all ANSI specifications for strength.



A13790

## GEAR RATCHET SPANNER SET 7PC

A13790

Code	Size (inch)	Code	Size (inch)	Code	Size (inch)
A13791	5/16	A13794	1/2	A13797	3/4
A13792	3/8	A13795	9/16	-	-
A13793	7/16	A13796	5/8	-	-

AF set. Flex head one way gear ratchet spanners. Can rotate up to 180° for working in tight areas. Heads tensioned to maintain required position at all times. Highly polished CR-V exceeds all ANSI specifications for strength.



A13158

## LONG RING SPANNER SET 3PC

A13158

Code	Size (mm)
A13150	8 x 10
A13152	12 x 14
A13154	17 x 19

Metric set. Extra long ring spanners. Highly polished CR-MO. Packaged in a plastic wallet.



A13160



ALTERNATIVE  
Page No. 288

## LONG RING SPANNER SET 4PC

A13160

Code	Size (mm)	Code	Size (mm)
A13150	8 x 10	A13154	17 x 19
A13152	12 x 14	A13156	22 x 24

Metric set. Extra long ring spanners. Highly polished CR-MO. Packaged in a plastic wallet.



A13167

## LONG RING SPANNER SET 4PC

A13167

Code	Size (inch)	Code	Size (inch)
A13162	3/8 x 7/16	A13165	11/16 x 3/4
A13163	1/2 x 9/16	A13166	7/8 x 15/16

AF set. Extra long ring spanners. Highly polished CR-MO. Packaged in a plastic wallet.



**45° OFFSET RING SPANNER SET 6PC** A13145

Code	Size (mm)	Code	Size (mm)	Code	Size (mm)
A13428	8 x 9	A13430	12 x 13	A13434	16 x 17
A13429	10 x 11	A13433	14 x 15	A13435	18 x 19

Metric set. 45° Offset spanners. Highly polished CR-V. Packaged in a plastic wallet.



A13145

**45° OFFSET RING SPANNER SET 6PC** A13140

Code	Size (inch)	Code	Size (inch)	Code	Size (inch)
A13402	3/8 x 7/16	A13406	5/8 x 11/16	A13411	13/16 x 7/8
A13404	1/2 x 9/16	A13408	11/16 x 3/4	A13413	15/16 x 1

AF set. 45° Offset spanners. Highly polished CR-V. Packaged in a plastic wallet.



A13140

**OPEN END SPANNER SET 6PC** A13290

Standards:		ANSI B107.100.2002			
Code	Size (mm)	Code	Size (mm)	Code	Size (mm)
A13467	8 x 9	A13472	12 x 13	A13479	16 x 17
A13469	10 x 11	A13474	14 x 15	A13480	18 x 19

Metric set. Highly polished CR-V. Packaged in a plastic wallet.



A13290

**OPEN END SPANNER SET 6PC** A13285

Standards:		ANSI B107.100.2002			
Code	Size (inch)	Code	Size (inch)	Code	Size (inch)
A13494	1/4 x 5/16	A13496	1/2 x 9/16	A13498	3/4 x 7/8
A13495	3/8 x 7/16	A13497	5/8 x 11/16	A13499	7/8 x 1

AF set. Highly polished CR-V. Packaged in a plastic wallet.



A13285

**FLARE NUT SPANNER 6PC** A13541

Code	Size (mm)	Code	Size (mm)	Code	Size (mm)
A135806	6 x 8	A135826	13 x 14	A135846	19 x 21
A135816	10 x 12	A135836	15 x 17	A135856	22 x 24

Metric set. 6 point highly polished CR-V. Professional quality flare nut spanners. For use on compression nuts fitted on petrol and diesel injection pipes, hydraulic, gas or refrigeration systems. Packaged in a plastic wallet.



A13541

**FLARE NUT SPANNER SET 6PC** A13536

Code	Size (inch)	Code	Size (inch)	Code	Size (inch)
A135706	1/4 x 5/16	A135726	1/2 x 9/16	A135746	3/4 x 7/8
A135716	3/8 x 7/16	A135736	5/8 x 11/16	A135756	7/8 x 1

AF set. 6 point highly polished CR-V. Professional quality flare nut spanners. For use on compression nuts fitted on petrol and diesel injection pipes, hydraulic, gas or refrigeration systems. Packaged in a plastic wallet.



A13536

# 4. Spanner Sets & Accessories



A13542

## FLARE NUT SPANNER SET 3PC

A13542

Code	Size (mm)
A135816	10 x 12
A135826	13 x 14
A138536	15 x 17

Metric set. 6 point highly polished CR-V. Professional quality flare nut spanners. For use on compression nuts fitted on petrol and diesel injection pipes, hydraulic, gas or refrigeration systems. Packaged in a plastic wallet.



A13537

## FLARE NUT SPANNER SET 3PC

A13537

Code	Size (inch)
A135716	3/8 x 7/16
A135726	1/2 x 9/16
A135736	5/8 x 11/16

AF set. 6 point highly polished CR-V. Professional quality flare nut spanners. For use on compression nuts fitted on petrol and diesel injection pipes, hydraulic, gas or refrigeration systems. Packaged in a plastic wallet.



A13520-A13529

## COMBINATION SPANNERS SHORT

A13520-A13529

Code	Size (mm)	Weight (grams)	Length (mm)
A13520	10	32	102
A13521	11	44	110
A13522	12	44	110
A13523	13	52	113
A13524	14	68	118
A13525	15	76	125
A13526	16	76	125
A13527	17	100	131
A13528	18	100	131
A13529	19	112	137

Metric sizes. Extra short highly polished CR-V combination spanners.



A13510-A13516

## COMBINATION SPANNERS SHORT

A13510-A13516

Code	Size (inch)	Weight (grams)	Length (mm)
A13510	3/8	32	102
A13511	7/16	44	110
A13512	1/2	52	113
A13513	9/16	68	118
A13514	5/8	76	125
A13515	11/16	100	131
A13516	3/4	112	137

AF sizes. Extra short highly polished CR-V combination spanners.

**COMBINATION SPANNERS METRIC** ACM07TS-ACM21TS

Standards:		ANSI B107.100.2002	
Code	Size (mm)	Weight (grams)	Length (mm)
ACM07TS	7	19	116
ACM08TS	8	26	125
ACM09TS	9	30	135
ACM10TS	10	38	145
ACM11TS	11	51	155
ACM12TS	12	57	165
ACM13TS	13	69	175
ACM14TS	14	89	186
ACM15TS	15	104	196
ACM16TS	16	112	206
ACM17TS	17	125	217
ACM18TS	18	150	225
ACM19TS	19	153	235
ACM20TS	20	183	245
ACM21TS	21	207	255



ACM07TS-ACM21TS

Long series combination spanners. Thin style. Highly polished CR-V.

**COMBINATION SPANNERS METRIC** ACM22-ACM50

Standards:		ANSI B107.100.2002	
Code	Size (mm)	Weight (grams)	Length (mm)
ACM22	22	333	295
ACM23	23	333	295
ACM24	24	391	315
ACM25	25	495	338
ACM26	26	493	338
ACM27	27	580	360
ACM30	30	660	395
ACM32	32	860	430
ACM36	36	1347	510
ACM41	41	1680	550
ACM42	42	1680	550
ACM43	43	1680	550
ACM44	44	2075	610
ACM46	46	2075	610
ACM48	48	2754	650
ACM50	50	2754	650



ACM22-ACM50

Long series combination spanners. Highly polished CR-V.

**COMBINATION SPANNERS AF** AC8-AC56

Standards:		ANSI B107.100.2002	
Code	Size (inch)	Weight (grams)	Length (mm)
AC8	1/4	25	130
AC10	5/16	25	142
AC12	3/8	50	154
AC14	7/16	65	170
AC16	1/2	88	180
AC18	9/16	111	195
AC20	5/8	130	205
AC22	11/16	180	228
AC24	3/4	224	250
AC26	13/16	281	270
AC28	7/8	333	295
AC30	15/16	392	315
AC32	1	495	338
AC34	1-1/16	580	360
AC36	1-1/8	660	395
AC40	1-1/4	860	430
AC42	1-5/16	1040	470
AC44	1-3/8	1040	470
AC46	1-7/16	1347	510
AC48	1-1/2	1347	510
AC50	1-5/8	1680	550
AC52	1-3/4	2075	610
AC54	1-7/8	2754	650
AC56	2	2754	650



AC8-AC56

Long series combination spanners. Highly polished CR-V.



# 4. Spanner Sets & Accessories



A13708-A13719



**ALTERNATIVE**  
Page No. 284

## GEAR RATCHET SPANNERS METRIC

A13708-A13719

Code	Size (mm)	Weight (grams)	Length (mm)	Teeth	Torque (Nm)
A13708	8	30	89	72	22
A13709	9	34	93	72	29
A13710	10	46	98	72	52
A13711	11	52	100	72	59
A13712	12	62	106	72	67
A13713	13	68	110	72	84
A13714	14	82	113	72	116
A13715	15	91	118	72	147
A13716	16	104	121	72	181
A13717	17	117	126	72	197
A13718	18	145	131	72	224
A13719	19	155	135	72	238

Stubby reverse gear ratchet spanners with a raised 15 degree ring end. Crack nut or bolt with open end first before using gear ratchet end. Highly polished CR-V exceeds all ANSI specifications for strength.



A13761-A13768

## GEAR RATCHET SPANNERS AF

A13761-A13768

Code	Size (inch)	Weight (grams)	Length (mm)	Teeth	Torque (Nm)
A13761	5/16	28	89	72	22
A13762	3/8	48	97	72	52
A13763	7/16	52	100	72	67
A13764	1/2	68	110	72	84
A13765	9/16	79	114	72	116
A13766	5/8	105	121	72	181
A13767	11/16	125	127	72	197
A13768	3/4	157	135	72	238

Stubby reverse gear ratchet spanners with a raised 15 degree ring end. Crack nut or bolt with open end first before using gear ratchet end. Highly polished CR-V exceeds all ANSI specifications for strength.



A13608-A13619



**ALTERNATIVE**  
Page No. 295

## GEAR RATCHET SPANNERS METRIC

A13608-A13619

Code	Size (mm)	Weight (grams)	Length (mm)	Teeth	Torque (Nm)
A13608	8	41	144	72	22
A13609	9	48	147	72	22
A13610	10	63	156	72	52
A13611	11	74	164	72	59
A13612	12	87	172	72	67
A13613	13	98	180	72	84
A13614	14	113	187	72	116
A13615	15	130	200	72	147
A13616	16	155	213	72	181
A13617	17	186	217	72	197
A13618	18	213	240	72	224
A13619	19	234	250	72	238

Reverse gear. Crack nut or bolt with open end first before using gear ratchet end. Highly polished CR-V exceeds all applicable ANSI specifications for strength.



A13751-A13758

## GEAR RATCHET SPANNERS AF

A13751-A13758

Code	Size (inch)	Weight (grams)	Length (mm)	Teeth	Torque (Nm)
A13751	5/16	41	144	72	22
A13752	3/8	63	157	72	52
A13753	7/16	73	164	72	59
A13754	1/2	95	180	72	84
A13755	9/16	112	189	72	116
A13756	5/8	153	214	72	181
A13757	11/16	152	229	72	197
A13758	3/4	236	250	72	238

Reverse gear. Crack nut or bolt with open end first before using gear ratchet end. Highly polished CR-V exceeds all applicable ANSI specifications for strength.

**GEAR RATCHET SPANNERS METRIC** A13561-A13578

Code	Size (mm)	Weight (grams)	Depth (mm)	Length (mm)	Teeth
A13561	8	30	7	140	72
A13562	9	39	8	150	72
A13563	10	46	9	159	72
A13564	11	60	10	165	72
A13565	12	70	10	172	72
A13566	13	79	11	178	72
A13567	14	100	12	191	72
A13568	15	115	13	200	72
A13569	16	146	14	208	72
A13576	17	164	15	226	72
A13577	18	187	15	237	72
A13578	19	219	16	248	72

One way gear ratchet spanners. 72 teeth ratchet mechanism which operates within a 5° movement. Manufactured to work at higher torque levels than most other gear wrenches due to a unique patented offset gear tooth design. Crack nut or bolt with open end before using gear ratchet end. Exceed all applicable ANSI specifications for strength. Highly polished CR-V.



ALTERNATIVE  
Page No. 284



A13561-A13578

**GEAR RATCHET SPANNERS AF** A13551-A13558

Code	Size (inch)	Weight (grams)	Depth (mm)	Length (mm)	Teeth
A13551	5/16	30	7	140	72
A13552	3/8	47	9	159	72
A13553	7/16	56	10	165	72
A13554	1/2	80	11	178	72
A13555	9/16	100	12	191	72
A13556	5/8	146	14	208	72
A13557	11/16	163	15	226	72
A13558	3/4	219	16	248	72

One way gear ratchet spanners. 72 teeth ratchet mechanism which operates within a 5° movement. Manufactured to work at higher torque levels than most other gear wrenches due to a unique patented offset gear tooth design. Crack nut or bolt with open end before using gear ratchet end. Exceed all applicable ANSI specifications for strength. Highly polished CR-V.



ALTERNATIVE  
Page No. 284



A13551-A13558

**GEAR RATCHET SPANNERS METRIC** A13781-A13787

Code	Size (mm)	Weight (grams)	Length (mm)	Teeth	Torque (Nm)
A13781	8	43	126	72	52
A13782	10	67	135	72	52
A13783	12	78	145	72	67
A13784	13	94	153	72	85
A13785	14	111	158	72	116
A13786	17	168	189	72	197
A13787	19	232	212	72	238

Flex head one way gear ratchet spanners. Can rotate up to 180° for working in tight areas. Heads tensioned to maintain required position at all times. Highly polished CR-V exceeds all ANSI specifications for strength.



A13781-A13787

# 4. Spanner Sets & Accessories



A13791-A13797

## GEAR RATCHET SPANNERS AF

A13791-A13797

Code	Size (inch)	Weight (grams)	Length (mm)	Teeth	Torque (Nm)
A13791	5/16	42	126	72	52
A13792	3/8	63	135	72	52
A13793	7/16	73	140	72	59
A13794	1/2	95	153	72	84
A13795	9/16	113	158	72	116
A13796	5/8	152	178	72	181
A13797	3/4	231	213	72	238

Flex head one way gear ratchet spanners. Can rotate up to 180° for working in tight areas. Heads tensioned to maintain required position at all times. Highly polished CR-V exceeds all ANSI specifications for strength.



A13150-A13157

## LONG RING SPANNERS METRIC

A13150-A13157

Code	Size (mm)	Weight (grams)	Length (mm)
A13150	8 x 10	78	235
A13151	10 x 12	131	295
A13152	12 x 14	192	330
A13153	13 x 15	308	370
A13155	14 x 17	308	370
A13157	16 x 18	417	405
A13154	17 x 19	413	405
A13156	22 x 24	574	435

Extra long ring spanners. Highly polished CR-MO.



A13161-A13166

## LONG RING SPANNERS AF

A13161-A13166

Code	Size (inch)	Weight (grams)	Length (mm)
A13161	5/16 x 3/8	77	235
A13162	3/8 x 7/16	136	295
A13163	1/2 x 9/16	189	330
A13164	5/8 x 11/16	449	370
A13165	11/16 x 3/4	441	405
A13166	7/8 x 15/16	591	435

Extra long ring spanners. Highly polished CR-MO.



A131500-A131511



ALTERNATIVE  
Page No. 287

## LONG RING RATCHET SPANNERS

A131500-A131511

Code	Size (mm)	Weight (grams)	Length (mm)
A131500	8	78	238
A131501	9	78	238
A131502	10	140	295
A131503	11	140	295
A131504	12	241	329
A131505	13	241	329
A131506	14	301	370
A131507	15	301	370
A131508	16	366	410
A131509	17	366	410
A131510	18	378	421
A131511	19	378	421

Metric sizes. Extra long ring spanners. Steel hardness 47+. Highly polished CR-MO.



**45° OFFSET RING SPANNERS METRIC** A13428-A13441

Code	Size (mm)	Weight (grams)	Length (mm)	Torque (kg-fm)
A13428	8 x 9	55	175	3 x 4
A13429	10 x 11	88	195	7 x 8
A13430	12 x 13	98	205	9 x 12
A13433	14 x 15	132	230	16 x 20
A13434	16 x 17	174	240	25 x 27
A13435	18 x 19	199	250	31 x 33
A13437	21 x 23	292	290	38 x 46
A13439	24 x 27	450	370	52 x 68
A13441	30 x 32	696	395	83 x 92

Highly polished CR-V.



A13428-A13441

**45° OFFSET RING SPANNERS AF** A13400-A13415

Code	Size (inch)	Weight (grams)	Length (mm)	Torque (kg-fm)
A13400	1/4 x 5/16	45	165	2 x 3
A13402	3/8 x 7/16	88	195	7 x 8
A13404	1/2 x 9/16	118	220	12 x 17
A13406	5/8 x 11/16	174	240	25 x 30
A13408	11/16 x 3/4	199	250	30 x 33
A13411	13/16 x 7/8	292	290	38 x 42
A13413	15/16 x 1	450	360	52 x 63
A13415	1-1/8 x 1-1/4	696	395	74 x 91

Highly polished CR-V.



A13400-A13415

**OPEN END SPANNERS METRIC** A13467-A13480

Standards:		ANSI B107.100.2002	
Code	Size (mm)	Weight (grams)	Length (mm)
A13467	8 x 9	44	135
A13469	10 x 11	62	145
A13472	12 x 13	90	165
A13474	14 x 15	110	185
A13479	16 x 17	143	205
A13480	18 x 19	198	225

Highly polished CR-V.



A13467-A13480

**OPEN END SPANNERS AF** A13494-A13499

Standards:		ANSI B107.100.2002	
Code	Size (inch)	Weight (grams)	Length (mm)
A13494	1/4 x 5/16	28	125
A13495	3/8 x 7/16	62	145
A13496	1/2 x 9/16	90	165
A13497	5/8 x 11/16	143	205
A13498	11/16 x 3/4	198	225
A13499	15/16 x 1	300	263

Highly polished CR-V.



A13494-A13499

# 4. Spanner Sets & Accessories



A135806-A135856

## FLARE NUT SPANNERS METRIC

A135806-A135856

Code	Size (mm)	Weight (grams)	Length (mm)
A135806	6 x 8	36	135
A135816	10 x 12	58	154
A135826	13 x 14	95	175
A135836	15 x 17	144	195
A135846	19 x 21	240	230
A135856	22 x 24	310	255

6 point highly polished CR-V. Professional quality flare nut spanners. For use on compression nuts fitted on petrol and diesel injection pipes, hydraulic, gas or refrigeration systems.



A135706-A135756

## FLARE NUT SPANNERS AF

A135706-A135756

Code	Size (inch)	Weight (grams)	Length (mm)
A135706	1/4 x 5/16	35	135
A135716	3/8 x 7/16	63	152
A135726	1/2 x 9/16	102	177
A135736	5/8 x 11/16	135	195
A135746	3/4 x 7/8	250	235
A135756	7/8 x 1	295	255

6 point highly polished CR-V. Professional quality flare nut spanners. For use on compression nuts fitted on petrol and diesel injection pipes, hydraulic, gas or refrigeration systems.



RSMK-4



**SUPERSEDED**  
Page No. 288

## OBSTRUCTION SPANNER SET 5PC

RSMK-4

Size (mm)	Size (mm)
10 x 12	16 x 18
13 x 15	19 x 22
14 x 17	-

Metric set. Professional quality spanners for hard to access areas. Manufactured from CR-V 6140, hardened, tempered and chrome plated for corrosion protection. HRC 46. Packaged in a vacuum formed tray.



A13220

## E TYPE SPANNER SET 4PC

A13220

Size (mm)	Size (mm)
E6 x E8	E14 x E18
E10 x E12	E20 x E24

Metric set. Professional quality spanners. Highly polished CR-V. Packaged in a canvas wallet.

**3/8" DR CROWS FOOT SET 10PC**

10187

Size (mm)	Torque Rating (Nm)	Size (mm)	Torque Rating (Nm)
10	31	17	139
11	46	19	186
13	62	21	248
14	86	22	279
15	104	24	341

Metric set. Made from chrome plated Carbon Steel to a hardness of HRC 40-44.



10187

**3/8" DR CROWS FOOT SET 10PC**

10188

Size (inch)	Torque Rating (Nm)	Size (inch)	Torque Rating (Nm)
3/8	31	11/16	155
7/16	46	3/4	186
1/2	62	13/16	248
9/16	87	7/8	279
5/8	124	1	404

AF set. Made from chrome plated Carbon Steel to a hardness of HRC 40-44.



10188

**BOX TUBE SPANNER SET 10PC**

Size (mm)	Size (mm)	Size
6 x 7	14 x 15	Bar
8 x 9	16 x 17	Bar
10 x 11	18 x 19	-
12 x 13	20 x 22	-

Metric set. Packaged in a canvas wallet.



**SUPERSEDED**  
Page No. 294



DEWK10



# 4. Spanner Sets & Accessories

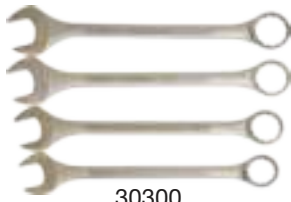

30300

## COMBINATION SPANNER SET 4PC

30300

Code	Size (inch)	Code	Size (inch)
30301	2-1/8	30303	2-3/8
30302	2-1/4	30304	2-1/2

AF set. Extra large jumbo raised panel spanners.



19827

## COMBINATION SPANNER SET 6PC

19827

Code	Size (mm)	Code	Size (mm)
19892	22	19897	27
19893	23	19900	30
19894	24	19902	32

Metric set. Large size raised panel spanners. Packaged in a wallet.



19828

## COMBINATION SPANNER SET 8PC

19828

Code	Size (inch)	Code	Size (inch)
19847	1	19851	1-5/16
19848	1-1/16	19852	1-3/8
19849	1-1/8	19853	1-7/16
19850	1-1/4	19854	1-1/2

AF set. Large size raised panel spanners. Packaged in a wallet.



15864

## COMBINATION SPANNER SET 12PC

15864

Code	Size (mm)	Code	Size (mm)	Code	Size (mm)
19876	6	19882	12	19887	17
19878	8	19883	13	19888	18
19880	10	19884	14	19889	19
19881	11	19886	16	19891	21

Metric set.



15862

## COMBINATION SPANNER SET 12PC

15862

Code	Size (inch)	Code	Size (inch)	Code	Size (inch)
19835	1/4	19839	1/2	19483	3/4
19836	5/16	19340	9/16	19844	13/16
19837	3/8	19841	5/8	19845	7/8
19838	7/16	19842	11/16	19846	15/16

AF set.



15860

## COMBINATION SPANNER SET 24PC

15860

Code	Size	Code	Size	Code	Size
19876	6mm	19886	15mm	19839	1/2"
19878	8mm	19887	17mm	19840	9/16"
19879	9mm	19889	19mm	19841	5/8"
19880	10mm	19891	21mm	19842	11/16"
19881	11mm	19835	1/4"	19843	3/4"
19882	12mm	19836	5/16"	19844	13/16"
19883	13mm	19837	3/8"	19845	7/8"
19884	14mm	19838	7/16"	19846	15/16"

Metric and AF set.

**10PC GEAR RATCHET SPANNER SET** 19990

Size (mm)	Size (mm)	Size (mm)	Size (mm)
8	12	15	19
10	13	17	
11	14	18	



19990

**8PC GEAR RATCHET SPANNER SET** 19991

Size (inch)	Size (inch)	Size (inch)
5/16	1/2	11/16
3/8	9/16	3/4
7/19	5/8	



19991

**COMBINATION SPANNER SET 6PC** 19830

Code	Size (mm)	Code	Size (mm)
19905	35	19914	44
19908	38	19918	48
19911	41	19921	51

Metric set. Extra large jumbo size raised panel spanners. Carbon steel HRC 40 - 50. Packaged in a wallet.



19830

**COMBINATION SPANNER SET 6PC** 19829

Code	Size (inch)	Code	Size (inch)
19852	1-3/8	19856	1-3/4
19854	1-1/2	19857	1-7/8
19855	1-5/8	19858	2

AF set. Extra large jumbo size raised panel spanners.



19829

**COMBINATION SPANNERS AF** 19835-30304

Code	Size (inch)	Weight (grams)	Length (mm)
19835	1/4	19.5	92
19836	5/16	27.5	102
19837	3/8	31.5	115
19838	7/16	41.2	130
19839	1/2	62	145
19840	9/16	58	168
19841	5/8	115	190
19842	11/16	141	210
19843	3/4	181	230
19844	13/16	215	257
19845	7/8	288	278
19846	15/16	356	305
19847	1	417	330
19848	1-1/16	528	355
19849	1-1/8	658	375
19850	1-1/4	802	410
19859	1-3/16	560	375
19851	1-5/16	800	410
19852	1-3/8	923	425
19853	1-7/16	923	425
19854	1-1/2	1063	455
19855	1-5/8	1445	495
19856	1-3/4	1445	495
19857	1-7/8	2347	563
19860	1-15/16	2000	563
19858	2	2347	563
30301	2-1/8	2600	625
30302	2-1/4	3000	640
30303	2-3/8	3500	660
30304	2-1/2	3870	680



19835-30304

Raised panel spanners.

# 4. Spanner Sets & Accessories



19810



19809

## OBSTRUCTION SPANNER SET 3PC

19810

Size (mm)	11 x 13	14 x 15	17 x 19
-----------	---------	---------	---------

Metric set.

## OBSTRUCTION SPANNER SET 3PC

19809

Size (inch)	7/16 x 1/2	9/16 x 5/8	11/16 x 3/4
-------------	------------	------------	-------------

AF set.

## COMBINATION SPANNERS METRIC

19876-19985

Code	Size (mm)	Weight (grams)	Length (mm)
19876	6	19.5	92
19877	7	21	98
19878	8	27.5	102
19879	9	31.5	115
19880	10	38.5	122
19881	11	41.2	130
19882	12	51	135
19883	13	62	145
19884	14	85	168
19885	15	115	190
19886	16	115	190
19887	17	141	210
19888	18	141	210
19889	19	181	230
19890	20	181	230
19891	21	215	257
19892	22	288	278
19893	23	288	278
19894	24	256	305
19895	25	418	330
19896	26	418	330
19897	27	528	355
19898	28	528	355
19900	30	658	375
19901	31	802	410
19902	32	804	410
19903	33	800	410
19905	35	923	425
19906	36	923	425
19908	38	1063	455
19911	41	1445	495
19913	43	1445	495
19914	44	1445	495
19916	46	1445	495
19918	48	2347	563
19921	51	2347	563
19955	55	2500	617
19957	57	2700	635
19960	60	3200	660
19965	65	4000	682
19970	70	6500	758
19975	75	6600	758
19980	80	7400	850
19985	85	7500	850



19876-19985



## 5. Slogging & Podger Spanners

# Tough tools for the big jobs.

KC Tools Slogging and Podger spanners are made from high strength steel and are heat treated for the ultimate combination of strength and durability. These spanners are designed for impact tightening and the removal of the largest nuts by striking with a sledge hammer or air impact hammer.

Our range of industrial Slogging and Podger spanners has the strength and endurance to withstand the most intense hammering.

# 5. Slogging & Podger Spanners



91017-91160

## SLOGGING SPANNERS METRIC

91017-91160

Code	Standards:		DIN7444	
	Size (mm)	Weight (grams)	Diameter (mm)	Length (mm)
91017	17	170	42	165
91019	19	170	42	165
91022	22	230	42	165
91024	24	220	42	165
91027	27	330	46	175
91030	30	450	53	185
91032	32	440	53	185
91036	36	550	58	205
91041	41	710	64	225
91046	46	900	73	235
91050	50	1200	78	250
91055	55	1360	86	265
91060	60	1500	92	274
91065	65	1900	102	298
91070	70	2300	108	320
91075	75	2850	113	326
91080	80	3400	124	350
91085	85	4100	130	355
91090	90	5200	142	390
91095	95	5100	142	390
91100	100	6700	155	420
91105	105	6400	155	420
91110	110	8640	168	450
91115	115	8500	168	450
91120	120	10400	182	480
91125	125	10000	182	480
91130	130	12600	200	520
91135	135	12000	200	520
91140	140	11500	200	520
91145	145	16500	220	565
91150	150	16000	220	565
91155	155	15600	220	565
91160	160	16000	240	585

Designed for impact tightening and removal of large size nuts by striking with sledge hammer or air impact hammer.



10251-10269

## SOCKET PODGER SPANNERS METRIC

10251-10269

Code	Size (mm)	Weight (grams)	Depth (mm)	Length (mm)
10251	11 x 13	200	36	220
10250	13 x 17	280	45	280
10252	14 x 17	300	45	260
10253	17 x 19	470	50	305
10254	17 x 21	470	50	305
10255	19 x 21	470	50	305
10256	19 x 22	470	50	305
10257	19 x 24	440	37	315
10258	18 x 24	490	50	315
10259	21 x 24	460	50	315
10261	24 x 27	720	55	350
10262	21 x 27	800	55	355
10263	24 x 30	1200	65	400
10264	27 x 30	1200	65	400
10265	26 x 32	1200	65	400
10266	27 x 32	1200	65	400
10268	30 x 32	1320	65	445
10267	32 x 36	1320	68	445
10269	36 x 41	1330	68	445



10280

## SOCKET PODGER SPANNER AF

10280

Code	Size (inch)	Weight (grams)	Depth (mm)	Length (mm)
10280	1/2 x 3/4	600	53	330

**SLOGGING SPANNERS AF**

A92002-A92155

Code	Standards:		DIN7444	
	Size (inch)	Weight (grams)	Diameter (mm)	Length (mm)
A92002	7/8	220	42	165
A92003	15/16	220	42	165
A92004	1	330	46	175
A92005	1-1/16	330	46	175
A92010	1-1/8	450	53	185
A92015	1-3/16	450	53	185
A92020	1-1/4	440	53	185
A92025	1-5/16	440	53	185
A92030	1-3/8	550	58	205
A92035	1-7/16	550	58	205
A92040	1-1/2	710	64	225
A92045	1-9/16	710	64	225
A92050	1-5/8	710	64	225
A92055	1-3/4	900	73	235
A92060	1-13/16	900	73	235
A92065	1-7/8	900	73	235
A92070	1-15/16	1200	78	250
A92075	2	1200	78	250
A92076	2-1/16	1360	86	265
A92080	2-1/8	1360	86	265
A92081	2-3/16	1360	86	265
A92085	2-1/4	1500	92	274
A92090	2-5/16	1500	92	274
A92095	2-3/8	1500	92	274
A92100	2-7/16	1500	92	274
A92105	2-1/2	1900	102	298
A92110	2-9/16	1900	102	298
A92115	2-5/8	1900	102	298
A92120	2-3/4	2300	108	320
A92125	2-13/16	2300	108	320
A92130	2-7/8	2850	113	326
A92135	2-15/16	2850	113	326
A92140	3	2850	113	326
A92145	3-1/8	3400	124	350
A92146	3-1/16	3400	124	350
A92150	3-1/4	4100	130	355
A92151	3-5/8	4100	130	355
A92152	3-5/16	5200	142	390
A92155	3-1/2	5200	142	390



A92002-A92155

Designed for impact tightening and removal of large size nuts by striking with sledge hammer or air impact hammer.

**SINGLE OFFSET PODGER SPANNERS**

90100-90119

Code	Size (mm)	Weight (grams)	Length (mm)
90100	17	276	335
90101	19	276	335
90102	21	361	355
90103	22	361	355
90104	23	361	355
90105	24	563	395
90106	26	563	395
90107	27	653	410
90108	29	653	410
90109	30	806	420
90110	32	806	420
90111	35	1188	470
90112	36	1188	470
90113	38	1188	470
90114	41	1469	510
90115	46	2042	545
90116	50	2042	545
90117	55	3500	620
90118	58	3500	620
90119	60	6500	620



90100-90119



## 6. Torque Wrenches

**Our tools  
really  
torque.**

KC Tools now stock the impressive looking and highly functional AOK Torque Wrench Range which is well recognized around the world for accuracy and ease of use.

These Torque Wrenches all come with individual testing certification certificate verifying the manufacturing standard and QA procedure. We trust the AOK brand to deliver the highest quality our customers expect from our products.



**SEE AOK SECTION**





## 7. Impacta Sockets

# Tools that make an impact.

When it comes to impact driving tools, black chrome moly (Cr-Mo) sockets are the only option.

Ideal for heavy duty, industrial and professional applications, they are designed and built to last.

Available in 3/8", 1/2", 3/4", 1", 1-1/2" drives, we offer the most comprehensive range of sockets and accessories in both standard and deep.







Rated to mining specifications



Roll Stamped Material & Size



Laser etched NM rating



# 7. Impacta Sockets



11203

## 3/8" DR SOCKET SET 12PC

11203



Code	Size (mm)	Code	Size (mm)	Code	Size (mm)
11228	8	11232	12	11236	16
11229	9	11233	13	11237	17
11230	10	11234	14	11238	18
11231	11	11235	15	11239	19

Metric set. Packaged in a blow moulded storage case.



11200

## 3/8" DR SOCKET SET 8PC

11200



Code	Size (inch)	Code	Size (inch)	Code	Size (inch)
11255	5/16	11258	1/2	11261	11/16
11256	3/8	11259	9/16	11262	3/4
11257	7/16	11260	5/8	-	-

AF set. Packaged in a blow moulded storage case.



11209

## 3/8" DR SOCKET SET DEEP 13PC

11209



Code	Size (mm)	Code	Size (mm)	Code	Size (mm)
11267	7	11272	12	11276	16
11268	8	11273	13	11277	17
11269	9	11274	14	11278	18
11270	10	11275	15	11279	19
11271	11	-	-	-	-

Metric set. Packaged in a blow moulded storage case.



11206

## 3/8" DR SOCKET SET DEEP 8PC

11206



Code	Size (inch)	Code	Size (inch)	Code	Size (inch)
11285	5/16	11288	1/2	11291	11/16
11286	3/8	11289	9/16	11292	3/4
11287	7/16	11290	5/8	-	-

AF set. Packaged in a blow moulded storage case.

**3/8" DR SOCKETS STANDARD METRIC** 11226-11242

Standards:			DIN 3121 3129		
Code	Size (mm)	Weight (grams)	Diameter (mm)	Length (mm)	Torque Capacity (Nm / kg-cm)
11226	6	40	10	32	20 / 210
11227	7	40	12	32	33 / 339
11228	8	40	13	32	45 / 464
11229	9	40	16	32	60 / 612
11230	10	40	16	32	76 / 782
11231	11	41	17	32	96 / 979
11232	12	43	18	32	118 / 1204
11233	13	56	20	32	141 / 1438
11234	14	60	20	32	169 / 1724
11235	15	63	22	32	222 / 2260
11236	16	70	24	32	222 / 2260
11237	17	76	26	32	222 / 2260
11238	18	80	25	32	222 / 2260
11239	19	85	28	32	222 / 2260
11240	20	94	30	32	222 / 2260
11241	21	100	30	32	222 / 2260
11242	22	110	32	32	222 / 2260



11226-11242

**3/8" DR SOCKETS STANDARD METRIC** 11266-11282

Standards:			DIN 3121 3129		
Code	Size (mm)	Weight (grams)	Diameter (mm)	Length (mm)	Torque Capacity (Nm / kg-cm)
11266	6	115	10	63	21 / 210
11267	7	112	12	63	33 / 339
11268	8	108	13	63	46 / 464
11269	9	107	14	63	60 / 612
11270	10	105	15	63	77 / 782
11271	11	105	17	63	96 / 979
11272	12	102	18	63	118 / 1204
11273	13	112	20	63	141 / 1438
11274	14	120	20	63	169 / 1724
11275	15	125	22	63	222 / 2260
11276	16	136	23	63	222 / 2260
11277	17	152	26	63	222 / 2260
11278	18	180	25	63	222 / 2260
11279	19	194	27	63	222 / 2260
11280	20	210	29	63	222 / 2260
11281	21	225	29	63	222 / 2260
11282	22	238	32	63	222 / 2260



11266-11282

**3/8" DR SOCKETS STANDARD AF** 11255-11264

Standards:			DIN 3121 3129		
Code	Size (inch)	Weight (grams)	Diameter (mm)	Length (mm)	Torque Capacity (Nm / kg-cm)
11255	5/16	40	15	32	50 / 507
11256	3/8	40	15	32	75 / 760
11257	7/16	41	17	32	105 / 1071
11258	1/2	56	19	32	140/1429
11259	9/16	56	21	32	181 / 1843
11260	5/8	70	24	32	226 / 2304
11261	11/16	76	25	32	249 / 2535
11262	3/4	85	28	32	249 / 2535
11263	13/16	100	29	32	249 / 2535
11264	7/8	110	32	32	249 / 2535



11255-11264

**3/8" DR SOCKETS DEEP AF** 11285-11294

Standards:			DIN 3121 3129		
Code	Size (inch)	Weight (grams)	Diameter (mm)	Length (mm)	Torque Capacity (Nm / kg-cm)
11285	5/16	108	13	63	50 / 507
11286	3/8	105	16	63	75 / 706
11287	7/16	105	17	63	105 / 1071
11288	1/2	112	18	63	140 / 1429
11289	9/16	120	20	63	181 / 1843
11290	5/8	136	23	63	226 / 2304
11291	11/16	152	25	63	249 / 2535
11292	3/4	194	27	63	249 / 2535
11293	13/16	225	29	63	249 / 2535
11294	7/8	238	31	63	249 / 2535



11285-11294



# 7. Impacta Sockets



11214

11215

## 3/8" DR ADAPTORS

11214-11215

Standards:		DIN 3121 3129			
Code	Size	Weight (grams)	Diameter (mm)	Length (mm)	Torque Capacity (Nm / kg-cm)
11214	3/8" F to 1/4" M	42	22	28	62 / 633
11215	3/8" F to 1/2" M	61	22	36	202 / 2061



11216

## 3/8" DR UNIVERSAL JOINT

11216

Standards:		DIN 3121 3129			
Code	Size (inch)	Weight (grams)	Diameter (mm)	Length (mm)	Torque Capacity (Nm / kg-cm)
11216	3/8	73	20	52	112 / 1143

Limited 12 month warranty. Should only be used at a maximum angle of 30° to prevent potential failure.



11218



11219

## 3/8" DR EXTENSIONS

11218-11219

Standards:		DIN 3121 3129			
Code	Size (mm)	Weight (grams)	Diameter (mm)	Length (mm)	Torque Capacity (Nm / kg-cm)
11218	75	78	18	77	202 / 2061
11219	150	144	19	150	202 / 2061



11305

## 1/2" DR SOCKET SET 10PC

11305



Code	Size (mm)	Code	Size (mm)	Code	Size (mm)
11340	10	11345	15	11349	19
11342	12	11346	16	11351	21
11343	13	11347	17	11352	22
11344	14	-	-	-	-

Metric set. Packaged in a blow moulded case.



11301

## 1/2" DR SOCKET SET 10PC

11301



Code	Size (inch)	Code	Size (inch)	Code	Size (inch)
11371	3/8	11375	5/8	11378	13/16
11372	7/16	11376	11/16	11380	15/16
11373	1/2	11377	3/4	11326	Adaptor
11374	9/16	-	-	-	-

AF set. Packaged in a blow moulded case.

**1/2" DR SOCKET SET 16PC**

11300M

Code	Size (mm)	Code	Size (mm)	Code	Size (mm)	Code	Size (mm)
11340	10	11344	14	11348	18	11352	22
11341	11	11345	15	11349	19	11354	24
11342	12	11346	16	11350	20	11357	27
11343	13	11347	17	11351	21	11360	30

Metric set. Packaged in a blow moulded case.



11300M

**1/2" DR SOCKET SET 16PC**

11300A

Code	Size (inch)	Code	Size (inch)	Code	Size (inch)	Code	Size (inch)
11370	5/16	11374	9/16	11378	13/16	11382	1-1/16
11371	3/8	11375	5/8	11379	7/8	11383	1-1/8
11372	7/16	11376	11/16	11380	15/16	11384	1-3/16
11373	1/2	11377	3/4	11381	1	11385	1-1/4

AF set. Packaged in a blow moulded case.



11300A

**1/2" DR SOCKET SET DEEP 12PC**

11315-2

Code	Size (mm)	Code	Size (mm)	Code	Size (mm)
11440	10	11445	15	11449	19
11442	12	11446	16	11451	21
11443	13	11447	17	11452	22
11444	14	11448	18	11454	24

Metric set. Packaged in a blow moulded case.



11315-2

**1/2" DR SOCKET SET DEEP 10PC**

11311

Code	Size (inch)	Code	Size (inch)	Code	Size (inch)
11472	7/16	11476	11/16	11479	7/8
11473	1/2	11477	3/4	11480	15/16
11474	9/16	11478	13/16	11481	1
11475	5/8	-	-	-	-

AF set. Packaged in a blow moulded case.



11311

# 7. Impacta Sockets



11314

## 1/2" DR SOCKET SET DEEP 4PC

11314

Code	Size (mm)	Code	Size (mm)	Code	Size (mm)
11460	30	11464	34	11466	36
11462	32	-	-	-	-

Metric set. Packaged in a blow moulded case.



11321

## 1/2" DR SOCKET SET 20PC

11321

Code	Size (mm)	Code	Size (mm)	Code	Size (mm)
Standard Sizes:					
11340	10	11345	15	11349	19
11342	12	11346	16	11351	21
11343	13	11347	17	11352	22
11344	14	-	-	-	-
Deep Sizes:					
11440	10	11446	16	11451	21
11442	12	11447	17	11452	22
11443	13	11449	19	11454	24
11444	14	-	-	-	-

Metric set. Packaged in a blow moulded case.



11320

## 1/2" DR SOCKET SET 20PC

11320

Code	Size (inch)	Code	Size (inch)	Code	Size (inch)
Standard Sizes:					
11371	3/8	11375	5/8	11378	13/16
11372	7/16	11376	11/16	11379	7/8
11373	1/2	11377	3/4	11380	15/16
11374	9/16	-	-	-	-
Deep Sizes:					
11472	7/16	11476	11/16	11479	7/8
11473	1/2	11477	3/4	11480	15/16
11474	9/16	11478	13/16	11481	1
11475	5/8	-	-	-	-

AF set. Packaged in a blow moulded case.





## 1/2" DR SOCKETS METRIC

11338-11362

Standards:		DIN 3121 3129			ANSI	
Code	Size (mm)	Weight (grams)	Diameter (mm)	Length (mm)	Torque Ratings (Nm / kg-cm)	Standards
11338	8	110	15	38	147 / 1500	ANSI
11339	9	106	15	38	147 / 1500	ANSI
11340	10	102	17	38	147 / 1500	ANSI
11341	11	99	18	38	178 / 1816	ANSI
11342	12	97	19	38	212 / 2163	ANSI
11343	13	96	20	38	249 / 2540	ANSI
11344	14	98	22	38	288 / 2938	ANSI
11345	15	137	24	38	331 / 3377	ANSI
11346	16	132	24	38	377 / 3847	ANSI
11347	17	133	26	38	425 / 4337	ANSI
11348	18	135	28	38	477 / 4867	ANSI
11349	19	135	28	38	531 / 5418	ANSI
11350	20	139	30	38	569 / 5806	ANSI
11351	21	146	30	38	569 / 5806	ANSI
11352	22	150	32	38	569 / 5806	ANSI
11353	23	156	32	43	569 / 5806	ANSI
11354	24	162	34	38	569 / 5806	ANSI
11355	25	168	35	43	569 / 5806	DIN
11356	26	184	37	43	569 / 5806	DIN
11357	27	215	38	43	569 / 5806	DIN
11358	28	228	39	48	569 / 5806	DIN
11359	29	240	40	48	569 / 5806	DIN
11360	30	252	42	48	569 / 5806	DIN
11361	31	263	43	48	569 / 5806	DIN
11362	32	275	44	48	569 / 5806	DIN



11338-11362

## 1/2" DR SOCKETS DEEP METRIC

11438-11466

Standards:		DIN 3121 3129			ANSI	
Code	Size (mm)	Weight (grams)	Diameter (mm)	Length (mm)	Torque Ratings (Nm / kg-cm)	Standards
11438	8	137	14	77	147 / 1500	ANSI
11439	9	138	15	76	147 / 1500	ANSI
11440	10	140	17	78	147 / 1500	ANSI
11441	11	156	18	78	178 / 1816	ANSI
11442	12	162	19	78	212 / 2163	ANSI
11443	13	166	20	78	249 / 2540	ANSI
11444	14	157	22	78	288 / 2938	ANSI
11445	15	235	23	78	331 / 3377	ANSI
11446	16	232	24	78	377 / 3847	ANSI
11447	17	258	26	78	425 / 4337	ANSI
11448	18	258	28	78	477 / 4867	ANSI
11449	19	259	28	78	531 / 5418	ANSI
11450	20	266	32	78	569 / 5806	ANSI
11451	21	272	30	78	569 / 5806	ANSI
11452	22	319	32	78	569 / 5806	ANSI
11453	23	340	34	78	569 / 5806	ANSI
11454	24	328	34	78	569 / 5806	ANSI
11455	25	354	35	78	569 / 5806	DIN
11456	26	370	37	78	569 / 5806	DIN
11457	27	385	37	78	569 / 5806	DIN
11458	28	400	40	78	569 / 5806	DIN
11459	29	416	40	78	569 / 5806	DIN
11460	30	457	41	78	569 / 5806	DIN
11461	31	467	43	78	569 / 5806	DIN
11462	32	490	44	78	569 / 5806	DIN
11463	33	540	45	78	569 / 5806	DIN
11464	35	555	47	78	569 / 5806	DIN
11466	36	614	49	78	569 / 5806	DIN



11438-11466

# 7. Impacta Sockets

## 1/2" DR SOCKETS AF

11370-11385



11370-11385

Standards:		DIN 3121 3129			ANSI	
Code	Size (inch)	Weight (grams)	Diameter (mm)	Length (mm)	Torque Ratings (Nm / kg-cm)	Standards
11370	5/16	110	14	38	124 / 1267	ANSI
11371	3/8	104	17	38	169 / 1728	ANSI
11372	7/16	96	18	38	226 / 2304	ANSI
11373	1/2	94	20	38	294 / 2996	ANSI
11374	9/16	96	22	38	373 / 3802	ANSI
11375	5/8	134	24	38	463 / 4724	ANSI
11376	11/16	135	26	38	561 / 5716	ANSI
11377	3/4	135	28	38	561 / 5716	ANSI
11378	13/16	146	30	38	561 / 5716	ANSI
11379	7/8	150	32	38	561 / 5716	ANSI
11380	15/16	162	34	38	561 / 5716	ANSI
11381	1	172	36	38	561 / 5716	ANSI
11382	1-1/16	215	38	43	561 / 5716	DIN
11383	1-1/8	234	40	48	561 / 5716	DIN
11384	1-3/16	252	42	48	561 / 5716	DIN
11385	1-1/4	280	44	48	561 / 5716	DIN

## 1/2" DR SOCKETS DEEP AF

11470-11485



11470-11485

Standards:		DIN 3121 3129			ANSI	
Code	Size (inch)	Weight (grams)	Diameter (mm)	Length (mm)	Torque Ratings (Nm / kg-cm)	Standards
11470	5/16	137	14	78	124 / 1267	ANSI
11471	3/8	140	17	78	169 / 1728	ANSI
11472	7/16	154	18	78	226 / 2304	ANSI
11473	1/2	169	20	78	294 / 2996	ANSI
11474	9/16	170	22	78	373 / 3802	ANSI
11475	5/8	232	23	78	463 / 4724	ANSI
11476	11/16	250	25	78	565 / 5716	ANSI
11477	3/4	259	28	78	565 / 5716	ANSI
11478	13/16	268	30	78	565 / 5716	ANSI
11479	7/8	316	32	78	565 / 5716	ANSI
11480	15/16	328	34	78	565 / 5716	ANSI
11481	1	349	36	78	565 / 5716	ANSI
11482	1-1/16	385	38	78	565 / 5716	DIN
11483	1-1/8	430	40	78	565 / 5716	DIN
11484	1-3/16	457	42	78	565 / 5716	DIN
11485	1-1/4	495	44	78	565 / 5716	DIN

## 1/2" DR SOCKETS FLIP

11333-11334



11333-11334

Standards:		ANSI	
Code	Size (mm)	Torque Ratings (Nm / kg-cm)	
11333	17 x 19	425 - 531 / 4337 - 5418	
11334	19 x 21	531 - 569 / 5418 - 5806	

**1/2" DR THIN WALL SOCKET SET 4PC** 11316

Code	Size (mm)	Code	Size (mm)
11306	17	11308	21
11307	19	11309	27

Packaged in a blow moulded storage case. Popular colour coded deep impact sockets for working on inserted wheel studs and nuts fitted to alloy rims. Each socket comes with a protective plastic sleeve to prevent marking the alloy rims. Made from CR-MO steel.



11316

**1/2" DR THIN WALL SOCKET SET 3PC** 11310

Code	Size (mm)
11306	17
11307	19
11308	21

Packaged in a blow moulded storage case. Popular colour coded deep impact sockets for working on inserted wheel studs and nuts fitted to alloy rims. Each socket comes with a protective plastic sleeve to prevent marking the alloy rims. Made from CR-MO steel.



11310

**1/2" DR SOCKETS METRIC** 11306-11312

Standards:		ANSI	
Code	Description	Torque Rating (Nm / kg-cm)	
11306	17mm Thin Wall Deep Metric Socket (Blue)	425 / 4337	
11307	19mm Thin Wall Deep Metric Socket (Yellow)	531 / 5418	
11308	21mm Thin Wall Deep Metric Socket (Red)	569 / 5806	
11312	22mm Thin Wall Deep Metric Socket (Green)	569 / 5806	
11309	27mm Thin Wall Deep Metric Socket (Black)	569 / 5806	

Popular colour coded deep impact sockets for working on inserted wheel studs and nuts fitted to alloy rims. Each socket comes with a protective plastic sleeve to prevent marking the alloy rims. Made from CR-MO steel.



11306-11312

**1/2" DR SOCKET SET IN-HEX 8PC** 11323

STANDARDS:			DIN 3121 3129		
Code	Size (mm)	Code	Size (mm)	Code	Size (mm)
11390	10	11393	13	11396	17
11391	11	11394	14	11397	19
11392	12	11395	15	-	-

Metric set. Packaged in a blow moulded case.



11323

**1/2" DR SOCKET SET IN-HEX 8PC** 11322

STANDARDS:			DIN 3121 3129		
Code	Size (inch)	Code	Size (inch)	Code	Size (inch)
11490	1/4	11493	7/16	11496	5/8
11491	5/16	11494	1/2	11497	3/4
11492	3/8	11495	9/16	-	-

AF set. Packaged in a blow moulded case.



11322



# 7. Impacta Sockets



11324M-11324A

## 1/2" DR SOCKET SET IN-HEX 12PC

11324M

Standards:			DIN 3121 3129		
Code	Size (mm)	Code	Size (mm)	Code	Size (mm)
11386	6	11392	12	11398	16
11388	8	11393	14	11396	17
11390	10	11394	14	11399	18
11391	11	11395	15	11397	19

Metric set. Packaged in a blow moulded case.

## 1/2" DR SOCKET SET IN-HEX 12PC

11324A

Standards:			DIN 3121 3129		
Code	Size (inch)	Code	Size (inch)	Code	Size (inch)
11488	3/16	11492	3/8	11496	5/8
11489	7/32	11493	7/16	11497	3/4
11490	1/4	11494	1/2	11498	11/16
11491	5/16	11495	9/16	11499	13/16

AF set. Packaged in a blow moulded case.



11363-11401

## 1/2" DR SOCKETS IN-HEX METRIC

11363-11401

Standards:			DIN 3121 3129		
Code	Size (mm)	Weight (grams)	Diameter (mm)	Length (mm)	Torque (Nm)
11363	4	73	24	60	16
11364	5	76	24	60	30
11386	6	80	24	60	52
11387	7	84	24	60	78
11388	8	89	24	60	120
11389	9	93	24	60	170
11390	10	96	24	60	220
11391	11	102	24	60	295
11392	12	108	24	60	370
11393	13	119	24	60	480
11394	14	127	24	60	590
11395	15	168	24	75	727
11396	17	190	24	75	1000
11397	19	215	24	75	1400
11398	16	180	24	75	864
11399	18	205	24	75	1200
11400	20	225	24	75	1500
11401	21	240	24	75	1800



11487-11499

## 1/2" DR SOCKETS IN-HEX AF

11487-11499

Standards:			DIN 3121 3129		
Code	Size (inch)	Weight (grams)	Diameter (mm)	Length (mm)	Torque Ratings (Nm)
11487	5/32	73	24	60	16
11488	3/16	76	24	60	30
11489	7/32	80	24	60	52
11490	1/4	84	24	60	78
11491	5/16	89	24	60	120
11492	3/8	93	24	60	170
11493	7/16	102	24	60	295
11494	1/2	119	24	60	480
11495	9/16	127	24	60	590
11496	5/8	180	24	75	864
11497	3/4	215	24	75	1400
11498	11/16	190	24	75	1000
11499	13/16	240	24	75	1800

**1/2" DR IMPACT SOCKET SET 12PC**

113400

Standards:		DIN 3121 G12.5			
Code	Size (T)	Code	Size (T)	Code	Size (T)
113401	10	113405	27	113409	50
113402	15	113406	30	113410	55
113403	20	113407	40	113411	60
113404	25	113408	45	113412	70

Star set. Phosphate finish. Packaged in a black EVA tray and in a metal storage case. 54-58 HRC.



113400

**1/2" DR IMPACT SOCKETS STAR**

113401-113412

Standards:		DIN 3121 G12.5			
Code	Size (T)	Weight (grams)	Diameter (mm)	Length (mm)	Torque (Nm)
113401	10	73	25	78	4.5
113402	15	73	25	78	7.7
113403	20	73	25	78	12.7
113404	25	73	25	78	19.0
113405	27	73	25	78	26.9
113406	30	73	25	78	37.4
113407	40	85	25	78	65.1
113408	45	100	25	78	104
113409	50	120	25	78	159
113410	55	165	25	78	257
113411	60	180	25	78	445
113412	70	100	25	78	701



113401-113412

**1/2" DR ADAPTOR SET 6PC**

11331

Code	Description	Code	Description	Code	Description
11325	Uni Joint	11327	1/2" F to 3/4" M	11326	1/2" F to 3/8" M
11328	75mm Ext.Bar	11329	125mm Ext.Bar	11330	250mm Ext.Bar

Packaged in a blow moulded storage case.



11331

**1/2" DR ADAPTORS**

11326-11327

Standards:		DIN 3121 3129			
Code	Size	Weight (grams)	Diameter (mm)	Length (mm)	Torque (Nm / kg-cm)
11326	1/2" F to 3/8" M	60	25	38	202 / 2061
11327	1/2" F to 3/4" M	164	30	48	512 / 5224



11326

11327

**1/2" DR UNIVERSAL JOINT**

11325

Standards:		DIN 3121 3129			
Code	Size (inch)	Weight (grams)	Diameter (mm)	Length (mm)	Torque (Nm / kg-cm)
11325	1/2	147	24	75	284 / 2898

Limited 12 month warranty. Should only be used at a maximum angle of 30° to prevent potential failure.



11325

# 7. Impacta Sockets



11328-11330

## 1/2" DR EXTENSIONS

11328-11330

Code	Standards:		DIN 3121 3129	
	Size (mm)	Weight (grams)	Diameter (mm)	Torque (Nm / kg-cm)
11328	75	141	24	512 / 5224
11329	125	230	25	512 / 5224
11330	250	420	25	512 / 5224



11367

## 1/2" DR ROTARY EXTENSIONS

11367

Code	Standards:		DIN 3121 3129	
	Size (mm)	Weight (grams)	Torque (Nm)	Steel Hardness (HRC)
11367	200	420	512	41 - 45

High grade SCM440 chrome molybdenum. Phosphated finish. Includes rotary holder for ease of use.



11335-11336

## 1/2" DR PINS & "O" RINGS

11335-11336

Code	Description
11335	8mm to 14mm "O" Ring and Pin Set
11336	15mm to 32mm "O" Ring and Pin Set

Pins and O Rings are used to retain extensions to impact wrench and sockets to extension on 1/2" Drive.



113300

## 1/2" DR TORSION BAR SET 7PC

113300

Code	Size (ft lbs)	Code	Size (ft lbs)	Code	Size (ft lbs)
113301	55	113304	100	113306	140
113302	65	113305	120	113307	175
113303	80	-	-	-	-



113301-113307

## 1/2" DR TORSION BARS

113301-113307

Code	Description	Length (mm)
113301	55Ft lbs Torsion Bar (Red)	180
113302	65Ft lbs Torsion Bar (Yellow)	180
113303	80Ft lbs Torsion Bar (Green)	180
113304	100Ft lbs Torsion Bar (Blue)	180
113305	120Ft lbs Torsion Bar (White)	180
113306	140Ft lbs Torsion Bar (Black)	180
113307	175Ft lbs Torsion Bar (Orange)	180

Torsion bars are designed for use with standard and thin wall sockets. Eliminates damaging wheels when you torque wheel nuts with tight tolerances. Prevents over-torquing wheel nuts, brake pulsation, distortion of wheels. Easy and cost efficient to use. Flexes at torque pressure. The shaft will flex in sync with the impact blows from the wrench used for the job once the correct torque has been reached. Accuracy within 3%, Adjust speed adjustment setting of the torque on the impact wrench to work within the desired range listed.



**3/4" DR SOCKET SET 8PC**

11701

Code	Size (mm)	Code	Size (mm)	Code	Size (mm)
11507	24	11515	32	11524	41
11510	27	11517	34	11529	46
11513	30	11519	36	-	-

Metric set. Packaged in a blow moulded storage case.



11701-11700

**3/4" DR SOCKET SET 8PC**

11700

Code	Size (inch)	Code	Size (inch)	Code	Size (inch)
11553	1	11557	1-1/4	11560	1-7/16
11554	1-1/16	11558	1-5/16	11561	1-1/2
11555	1-1/8	11559	1-3/8	-	-

AF set. Packaged in a blow moulded storage case.



11709

**3/4" DR SOCKET SET 17PC**

11709

Code	Size (mm)	Code	Size (mm)	Code	Size (mm)	Code	Size (mm)
11504	21	11513	30	11518	35	11524	41
11505	22	11515	32	11519	36	11525	42
11506	23	11516	33	11521	38	11529	46
11507	24	11517	34	11523	40	11533	50
11510	27	-	-	-	-	-	-

Metric set. Packaged in a blow moulded storage case.

**3/4" DR SOCKET SET DEEP 8PC**

11705

Code	Size (mm)	Code	Size (mm)	Code	Size (mm)
11607	24	11615	32	11623	41
11610	27	11617	34	11626	46
11613	30	11619	36	-	-

Metric set. Packaged in a blow moulded storage case.



11705-11704

**3/4" DR SOCKET SET DEEP 8PC**

11704

Code	Size (inch)	Code	Size (inch)	Code	Size (inch)
11635	1	11639	1-1/4	11642	1-7/16
11636	1-1/16	11640	1-5/16	11643	1-1/2
11637	1-1/8	11641	1-3/8	-	-

AF Set. Packaged in a blow moulded storage case.

# 7. Impacta Sockets

## 3/4" DR SOCKETS METRIC

11500-11547



Code	Standards:		DIN 3121 3129		Torque Ratings (Nm / kg-cm)	ANSI Standards
	Size (mm)	Weight (grams)	Diameter (mm)	Length (mm)		
11500	17	375	30	51	569 / 5806	ANSI
11501	18	376	31	51	570 / 5806	ANSI
11502	19	375	32	51	571 / 5806	ANSI
11503	20	375	33	51	572 / 5806	ANSI
11504	21	373	35	51	573 / 5806	ANSI
11505	22	373	36	51	574 / 5806	ANSI
11506	23	372	37	51	575 / 5806	ANSI
11507	24	371	38	51	576 / 5806	ANSI
11508	25	368	40	51	583 / 5949	ANSI
11509	26	366	41	50	624 / 6367	ANSI
11510	27	395	42	53	666 / 6786	ANSI
11511	28	398	44	53	707 / 7214	ANSI
11512	29	407	45	53	707 / 7214	ANSI
11513	30	420	46	53	796 / 8112	ANSI
11514	31	458	47	53	796 / 8112	DIN
11515	32	468	48	57	889 / 9061	ANSI
11516	33	488	50	57	889 / 9061	ANSI
11517	34	497	51	57	985 / 10040	DIN
11518	35	512	52	56	985 / 10040	ANSI
11519	36	526	53	56	985 / 10040	ANSI
11520	37	554	55	57	1085 / 11061	DIN
11521	38	565	56	57	1085 / 11061	DIN
11522	39	583	57	57	1085 / 11061	DIN
11523	40	611	58	57	1085 / 11061	DIN
11524	41	622	60	57	1354 / 13806	DIN
11525	42	642	61	57	1354 / 13806	DIN
11526	43	715	62	62	1354 / 13806	DIN
11527	44	734	63	62	1354 / 13806	DIN
11528	45	751	65	62	1354 / 13806	DIN
11529	46	772	66	62	1570 / 16010	DIN
11530	47	852	67	57	1570 / 16010	DIN
11531	48	872	68	57	1570 / 16010	DIN
11532	49	918	70	70	1570 / 16010	DIN
11533	50	1161	71	72	1570 / 16010	DIN
11534	51	1165	72	72	1570 / 16010	DIN
11535	52	1190	73	72	1570 / 16010	DIN
11536	53	1214	75	72	1570 / 16010	DIN
11537	54	1244	76	72	1570 / 16010	DIN
11538	55	1310	77	74	1570 / 16010	DIN
11539	56	1338	79	74	1570 / 16010	DIN
11540	57	1368	80	74	1570 / 16010	DIN
11541	58	1435	81	75	1570 / 16010	DIN
11542	59	1455	82	75	1570 / 16010	DIN
11543	60	1488	83	75	1570 / 16010	DIN
11544	63	1572	87	75	1570 / 16010	DIN
11545	65	1704	90	78	1570 / 16010	DIN
11546	67	1818	92	80	1570 / 16010	DIN
11547	70	1987	96	88	1570 / 16010	DIN



11500-11547



### 3/4" DR SOCKETS DEEP METRIC

11600-11628

Code	Standards:		DIN 3121 3129		
	Size (mm)	Weight (grams)	Diameter (mm)	Length (mm)	Torque Ratings (Nm / kg-cm)
11600	17	574	30	90	569 / 5806
11601	18	588	31	90	569 / 5806
11602	19	599	32	90	569 / 5806
11603	20	611	34	90	569 / 5806
11604	21	633	35	90	569 / 5806
11605	22	642	36	90	569 / 5806
11606	23	637	37	90	569 / 5806
11607	24	637	38	90	569 / 5806
11608	25	641	40	90	583 / 5949
11609	26	645	41	90	624 / 6367
11610	27	632	42	90	665 / 6786
11611	28	639	44	90	707 / 7214
11612	29	656	45	90	707 / 7214
11613	30	679	46	90	795 / 8112
11614	31	729	47	90	795 / 8112
11615	32	736	48	90	888 / 9061
11616	33	771	50	90	888 / 9061
11617	34	788	54	90	984 / 10040
11618	35	815	52	90	984 / 10040
11619	36	840	54	90	984 / 10040
11620	37	862	55	90	1085 / 11061
11621	38	882	56	90	1085 / 11061
11622	40	910	58	90	1085 / 11061
11623	41	970	60	90	1354 / 13806
11624	42	1006	61	90	1354 / 13806
11625	43	1037	62	90	1354 / 13806
11626	46	1256	66	90	1570 / 16010
11627	49	1425	70	90	1570 / 16010
11628	50	1647	71	90	1570 / 16010



11600-11628

### 3/4" DR SOCKETS AF

11548-11579

Code	Standards:		DIN 3121 3129		ANSI	
	Size (inch)	Weight (grams)	Diameter (mm)	Length (mm)	Torque Ratings (Nm / kg-cm)	Standards
11548	11/16	375	30	50	576 / 5876	ANSI
11549	3/4	375	32	51	678 / 6913	ANSI
11550	13/16	375	35	51	768 / 7834	ANSI
11551	7/8	373	36	50	870 / 8871	ANSI
11552	15/16	371	38	51	983 / 10023	ANSI
11553	1	368	41	50	1096 / 11176	ANSI
11554	1-1/16	395	42	53	1220 / 12443	ANSI
11555	1-1/8	402	45	53	1345 / 13710	ANSI
11556	1-3/16	420	46	53	1469 / 14978	ANSI
11557	1-1/4	468	48	51	1604 / 16360	ANSI
11558	1-5/16	490	47	57	1740 / 17743	ANSI
11559	1-3/8	512	52	57	1887 / 19240	ANSI
11560	1-7/16	540	53	57	2034 / 20738	ANSI
11561	1-1/2	565	56	57	2034 / 20738	DIN
11562	1-9/16	611	58	57	2034 / 20738	DIN
11563	1-5/8	622	60	57	2034 / 20738	DIN
11564	1-11/16	715	62	62	2034 / 20738	DIN
11565	1-3/4	740	64	62	2034 / 20738	DIN
11566	1-13/16	772	66	64	2034 / 20738	DIN
11567	1-7/8	872	68	67	2034 / 20738	DIN
11568	1-15/16	918	70	70	2034 / 20738	DIN
11569	2	1165	72	72	2034 / 20738	DIN
11570	2-1/16	1205	73	72	2034 / 20738	DIN
11571	2-1/8	1244	76	72	2034 / 20738	DIN
11572	2-3/16	1320	79	74	2034 / 20738	DIN
11573	2-1/4	1381	80	74	2034 / 20738	DIN
11574	2-5/16	1455	82	75	2034 / 20738	DIN
11575	2-3/8	1488	83	75	2034 / 20738	DIN
11576	2-1/2	1602	87	75	2034 / 20738	DIN
11577	2-9/16	1704	90	78	2034 / 20738	DIN
11578	2-5/8	1800	92	80	2034 / 20738	DIN
11579	2-3/4	1987	95	88	2034 / 20738	DIN



11548-11579



# 7. Impacta Sockets



11630-11651

## 3/4" DR SOCKETS DEEP AF

11630-11651

Code	Standards:			DIN 3121 3129	
	Size (inch)	Weight (grams)	Diameter (mm)	Length (mm)	Torque Ratings (Nm / kg-cm)
11630	11/16	580	30	90	576 / 5876
11631	3/4	599	32	90	678 / 6913
11632	13/16	625	34	90	768 / 7834
11633	7/8	642	36	90	870 / 8871
11634	15/16	637	38	90	983 / 10023
11635	1	645	40	90	1096 / 11176
11636	1-1/16	632	42	90	1220 / 12443
11637	1-1/8	646	44	90	1345 / 13710
11638	1-3/16	679	46	90	1469 / 14978
11639	1-1/4	736	48	90	1604 / 16360
11640	1-5/16	780	50	90	1740 / 17743
11641	1-3/8	815	52	90	1887 / 19240
11642	1-7/16	850	54	90	2034 / 20738
11643	1-1/2	882	56	90	2034 / 20738
11644	1-9/16	910	58	90	2034 / 20738
11645	1-5/8	970	60	90	2034 / 20738
11646	1-11/16	1037	62	90	2034 / 20738
11647	1-3/4	1150	64	90	2034 / 20738
11648	1-13/16	1256	66	90	2034 / 20738
11649	1-7/8	1310	70	90	2034 / 20738
11650	1-15/16	1425	70	90	2034 / 20738
11651	2	1710	72	99	2034 / 20738



11689-11692

## 3/4" DR SOCKETS SQUARE METRIC

11689-11692

Code	Standards:			DIN 3121 3129	
	Size (mm)	Weight (grams)	Diameter (mm)	Length (mm)	Torque Ratings (Nm / kg-cm)
11690	17	350	37	50	569 / 5806
11691	19	350	39	51	569 / 5806
11689	20	360	40	51	569 / 5806
11692	21	362	42	51	569 / 5806



11693-11695

## 3/4" DR SOCKETS SQUARE AF

11693-11695

Code	Standards:			DIN 3121 3129	
	Size (inch)	Weight (grams)	Diameter (mm)	Length (mm)	Torque Ratings (Nm / kg-cm)
11693	11/16	350	37	50	576 / 5876
11694	3/4	350	39	51	679 / 6913
11695	13/16	362	42	51	768 / 7834



11713-11715

## 3/4" BUDD SOCKETS

11713-11715

Code	Standards:			DIN 3121 3129	
	Size (mm)	Weight (grams)	Diameter (mm)	Length (mm)	Torque Ratings (Nm / kg-cm)
11713	35 x 17				
11715	41 x 21				

**3/4" DR SOCKET SET IN-HEX 7PC**

116540

Standards:			DIN 3121 3129		
Code	Size (mm)	Code	Size (mm)	Code	Size (mm)
116546	19	116550	24	116555	30
116547	21	116553	27	116556	32
116548	22	-	-	-	-

Metric set. Packaged in a blow moulded storage case.



116540

**3/4" DR SOCKET SET IN-HEX 7PC**

116521

Standards:			DIN 3121 3129		
Code	Size (inch)	Code	Size (inch)	Code	Size (inch)
116525	3/4	116529	1	116532	1-3/16
116527	7/8	116530	1-1/16	116533	1-1/4
116528	15/16	-	-	-	-

AF set. Packaged in a blow moulded storage case.



116521

**3/4" DR SOCKET SET IN-HEX 9PC**

116520

Standards:			DIN 3121 3129		
Code	Size (inch)	Code	Size (inch)	Code	Size (inch)
116525	3/4	116528	15/16	116531	1-1/8
116526	13/16	116529	1	116532	1-3/16
116527	7/8	116530	1-1/16	116533	1-1/4

AF set. Packaged in a blow moulded storage case.



116520

**3/4" DR SOCKETS IN-HEX METRIC**

116538-116560

Standards:			DIN 3121 3129		
Code	Size (mm)	Weight (grams)	Diameter (mm)	Length (mm)	Torque Rating (Nm / kg-cm)
116538	12	371	44	89	370 / 4458
116541	14	394	44	89	590 / 6017
116544	17	468	44	89	1000 / 10196
116546	19	680	44	89	1400 / 14276
116547	21	690	44	89	1867 / 19034
116548	22	700	44	89	2100 / 21413
116549	23	710	44	89	2400 / 24472
116550	24	720	44	89	2700 / 27531
116553	27	750	44	89	2700 / 27531
116555	30	770	44	89	2700 / 27531
116556	32	800	44	89	2700 / 27531
116560	36	842	44	89	2700 / 27531



116538-116560

**3/4" DR SOCKETS IN-HEX AF**

116522-116533

Standards:			DIN 3121 3129		
Code	Size (inch)	Weight (grams)	Diameter (mm)	Length (mm)	Torque Rating (Nm / kg-cm)
116522	9/16	424	44	89	590 / 6017
116523	5/8	452	44	89	865 / 8823
116524	11/16	641	44	89	1196 / 12196
116525	3/4	680	44	89	1400 / 14276
116526	13/16	690	44	89	1867 / 19034
116527	7/8	700	44	89	2100 / 21413
116528	15/16	720	44	89	2700 / 27531
116529	1	740	44	89	2700 / 27531
116530	1-1/16	750	44	89	2700 / 27531
116531	1-1/8	760	44	89	2700 / 27531
116532	1-3/16	770	44	89	2700 / 27531
116533	1-1/4	800	44	89	2700 / 27531



116522-116533

# 7. Impacta Sockets



11711

## 3/4" DR IMPACT ADAPTOR SET 5PC

11711

Code	Description	Code	Description
11670	Uni Joint	11676	150mm Ext. Bar
11672	3/4" F to 1/2" M	11679	250mm Ext. Bar
11673	3/4" F to 1" M	-	-

Packaged in a blow moulded storage case.



11672

11673

## 3/4" DR ADAPTORS

11672-11673

Standards:		DIN 3121 3129			
Code	Size	Weight (grams)	Diameter (mm)	Length (mm)	Torque Rating (Nm / kg-cm)
11672	3/4" F to 1/2" M	326	44	58	512 / 5224
11673	3/4" F to 1" M	420	44	63	1413 / 14408



11670

## 3/4" DR UNIVERSAL JOINT

11670

Standards:		DIN 3121 3129		
Code	Size (inch)	Weight (grams)	Diameter (mm)	Length (mm)
11670	3/4	750	44	112
Ball Diameter (mm)	Torque Rating (Nm / kg-cm)	Breaking Test (kg-cm)	Pin Diameter (mm)	
30	785 / 8000	16656	8	

Should only be used at a maximum angle of 30° to prevent potential failure. Fatigue test torque testing 3000 times at 800Nm. Made to 47 - 48 HRC. Limited 12 month warranty.



11676-11679

## 3/4" DR EXTENSIONS

11676-11679

Standards:		DIN 3121 3129		
Code	Size (mm)	Weight (grams)	Diameter (mm)	Torque Rating (Nm / kg-cm)
11676	150	789	44	1413 / 14408
11679	250	1350	44	1413 / 14408



11675

## 3/4" DR ROTARY EXTENSIONS

11675

Standards:		DIN 3121 3129		
Code	Size (mm)	Weight (grams)	Torque (Nm)	Steel Hardness (HRC)
11675	250	1260	1412	41 - 45

High grade SCM440 chrome molybdenum. Phosphated finish. Includes rotary holder for ease of use.



11680-11685

## 3/4" DR PINS & "O" RINGS

11680-11685

Code	Description
11680	17mm to 49mm "O" Ring
11681	50mm to 70mm "O" Ring
11682	17mm to 49mm Pin
11683	50mm to 70mm Pin
11684	17mm to 49mm "O" Ring and Pin Set
11685	50mm to 70mm "O" Ring and Pin Set

Pins and "O" Rings are used to retain extensions to impact wrench and sockets to extensions on 3/4" Drive.



**1" DR SOCKET SET 9PC**

11801

Standards:		DIN 3121 3129			
Code	Size (mm)	Code	Size (mm)	Code	Size (mm)
11724	24	11732	32	11741	41
11727	27	11736	36	11746	46
11730	30	11738	38	11750	50

Metric set. Packaged in a blow moulded storage case.



11801

**1" DR SOCKET SET 9PC**

11800

Standards:		DIN 3121 3129			
Code	Size (inch)	Code	Size (inch)	Code	Size (inch)
11835	1	11840	1-5/16	11847	1-3/4
11837	1-1/8	11843	1-1/2	11849	1-7/8
11839	1-1/4	11845	1-5/8	11851	2

AF set. Packaged in a blow moulded storage case.



11800

**1" DR SOCKET SET DEEP 7PC**

11803

Standards:		DIN 3121 3129			
Code	Size (mm)	Code	Size (mm)	Code	Size (mm)
11885	21	11894	30	11900	36
11888	24	11896	32	11902	38
11891	27	-	-	-	-

Metric set. Packaged in a blow moulded storage case.



11803

**1" DR SOCKET SET DEEP 7PC**

11802

Standards:		DIN 3121 3129			
Code	Size (inch)	Code	Size (inch)	Code	Size (inch)
11953	15/16	11956	1-1/8	11959	1-5/16
11954	1	11958	1-1/4	11962	1-1/2
11955	1-1/16	-	-	-	-

AF set. Packaged in a blow moulded storage case.



11802

# 7. Impacta Sockets

## 1" DR SOCKETS METRIC

11717-11795



11717-11795

Code	Standards:			DIN 3121 3129	
	Size (mm)	Weight (grams)	Diameter (mm)	Length (mm)	Torque Rating (Nm / kg-cm)
11717	17	660	33	58	886 / 9030
11719	19	665	35	58	886 / 9030
11721	21	665	38	58	979 / 9979
11722	22	664	39	58	1026 / 10459
11723	23	663	40	58	1072 / 10929
11724	24	662	41	58	1119 / 11408
11725	25	660	43	58	1166 / 11887
11726	26	658	44	58	1212 / 12357
11727	27	656	45	58	1259 / 12836
11728	28	654	47	58	1305 / 13306
11729	29	660	48	60	1352 / 13785
11730	30	670	49	60	1398 / 14255
11731	31	670	50	60	1441 / 14694
11732	32	673	51	61	1492 / 15214
11733	33	674	53	61	1538 / 15684
11734	34	676	54	61	1585 / 16163
11735	35	678	55	61	1631 / 16632
11736	36	680	56	65	1678 / 17112
11737	37	703	58	65	1702 / 17357
11738	38	723	59	65	1771 / 18061
11739	39	746	60	65	1813 / 18490
11740	40	765	61	65	1864 / 19010
11741	41	818	63	65	1911 / 19490
11742	42	843	64	68	1956 / 19950
11743	43	866	65	68	2004 / 20439
11744	44	888	57	68	2086 / 21275
11746	46	1015	59	74	2144 / 21867
11747	47	1038	70	74	2195 / 22377
11748	48	1067	71	74	2238 / 22816
11749	49	1086	73	74	2283 / 23275
11750	50	1214	74	74	2331 / 23765
11751	51	1250	75	80	2378 / 24245
11752	52	1351	76	80	2424 / 24714
11753	53	1385	78	80	2479 / 25275
11754	54	1409	79	80	2517 / 25663
11755	55	1541	80	85	2564 / 26143
11756	56	1576	82	85	2600 / 26510
11757	57	1609	83	85	2657 / 27092
11758	58	1657	84	85	2704 / 27571
11759	59	1679	85	85	2750 / 28040
11760	60	1875	87	89	2797 / 28520
11762	62	1984	89	89	2797 / 28520
11763	63	2022	90	89	2797 / 28520
11765	65	2171	93	93	2797 / 28520
11767	67	2298	95	93	2797 / 28520
11768	68	2412	96	93	2797 / 28520
11770	70	2513	99	98	2797 / 28520
11773	73	2910	103	98	2797 / 28520
11775	75	3593	105	100	2797 / 28520
11776	76	3715	106	100	2797 / 28520
11778	78	3840	109	100	2797 / 28520
11780	80	3981	111	100	2797 / 28520
11785	85	4289	118	102	2797 / 28520
11789	89	4486	123	107	2797 / 28520
11790	90	4880	124	107	2797 / 28520
11792	92	4710	126	107	2797 / 28520
11795	95	5106	130	107	2797 / 28520

**1" DR SOCKETS DEEP METRIC**

11881-11929

Code	Standards:			DIN 3121 3129	
	Size (mm)	Weight (grams)	Diameter (mm)	Length (mm)	Torque Rating (Nm / kg-cm)
11881	17	787	33	90	885 / 9030
11883	19	840	35	90	885 / 9030
11885	21	830	38	90	978 / 9979
11886	22	820	39	90	1025 / 10459
11887	23	810	40	90	1071 / 10929
11888	24	800	41	90	1118 / 11408
11889	25	850	43	90	1165 / 11887
11890	26	900	44	90	1211 / 12357
11891	27	950	45	90	1258 / 12836
11892	28	960	47	90	1304 / 13306
11893	29	980	48	90	1351 / 13785
11894	30	1020	49	90	1397 / 14255
11895	31	1010	50	91	1441 / 14694
11896	32	1007	51	90	1492 / 15214
11897	33	1008	53	90	1538 / 15684
11898	34	1010	54	90	1585 / 16163
11899	35	1015	55	90	1631 / 16632
11900	36	1035	56	90	1678 / 17112
11901	37	1075	58	90	1702 / 17357
11902	38	1099	59	90	1771 / 18061
11903	39	1125	60	90	1813 / 18490
11904	40	1140	61	90	1864 / 19010
11905	41	1160	63	90	1911 / 19490
11906	42	1210	64	90	1956 / 19950
11907	43	1270	65	90	2004 / 20439
11908	46	1500	69	100	2144 / 21867
11909	47	1540	70	100	2194 / 22377
11910	48	1550	72	100	2237 / 22816
11911	49	1560	73	100	2282 / 23275
11912	50	1600	74	100	2330 / 23765
11913	51	1650	75	100	2377 / 24245
11914	52	1700	76	100	2423 / 24714
11915	54	1750	79	100	2516 / 25663
11916	55	1850	80	100	2563 / 26143
11917	56	1960	82	105	2599 / 26510
11918	57	1980	83	105	2656 / 27092
11919	58	2060	84	105	2703 / 27571
11920	59	2100	85	105	2749 / 28040
11921	60	2450	86	120	2797 / 28520
11922	63	2620	91	120	2797 / 28520
11923	65	2780	93	120	2797 / 28520
11924	68	3000	96	120	2797 / 28520
11925	70	3230	99	125	2797 / 28520
11926	75	4370	105	125	2797 / 28520
11927	80	4580	111	125	2797 / 28520
11928	85	4900	118	135	2797 / 28520
11929	90	5000	124	135	2797 / 28520



11881-11929



# 7. Impacta Sockets

## 1" DR SOCKETS AF

11830-11874



11830-11874

Code	Standards:			DIN 3121 3129	
	Size (inch)	Weight (grams)	Diameter (mm)	Length (mm)	Torque Rating (Nm / kg-cm)
11830	11/16	660	33	58	610 / 6221
11831	3/4	665	35	58	723 / 7373
11832	13/16	665	37	58	836 / 8525
11833	7/8	664	39	58	949 / 9678
11834	15/16	662	41	58	1062 / 10830
11835	1	652	43	58	1186 / 12097
11836	1-1/16	656	45	58	1321 / 13480
11837	1-1/8	658	47	60	1446 / 14747
11838	1-3/16	670	48	60	1593 / 16245
11839	1-1/4	673	51	61	1740 / 17743
11840	1-5/16	674	53	62	1886 / 19240
11841	1-3/8	678	55	64	2033 / 20738
11842	1-7/16	695	57	65	2203 / 22466
11843	1-1/2	723	59	65	2372 / 24195
11844	1-9/16	765	61	65	2485 / 25347
11845	1-5/8	818	63	65	2711 / 27651
11846	1-11/16	866	65	68	2937 / 29950
11847	1-3/4	912	67	69	3050 / 31107
11848	1-13/16	1015	69	74	3164 / 32260
11849	1-7/8	1067	71	74	3164 / 32260
11850	1-15/16	1086	73	74	3164 / 32260
11851	2	1250	75	80	3164 / 32260
11852	2-1/16	1371	77	80	3164 / 32260
11853	2-1/8	1409	79	80	3164 / 32260
11854	2-3/16	1565	81	85	3164 / 32260
11855	2-1/4	1609	82	85	3164 / 32260
11856	2-5/16	1679	85	85	3164 / 32260
11857	2-3/8	1875	87	89	3164 / 32260
11858	2-7/16	1984	90	89	3164 / 32260
11859	2-1/2	2055	91	89	3164 / 32260
11860	2-9/16	2171	93	93	3164 / 32260
11861	2-5/8	2298	93	93	3164 / 32260
11862	2-11/16	2426	97	93	3164 / 32260
11863	2-3/4	2513	99	98	3164 / 32260
11864	2-13/16	2746	101	98	3164 / 32260
11865	2-7/8	2910	103	98	3164 / 32260
11866	2-15/16	3593	105	100	3164 / 32260
11867	3	3715	106	100	3164 / 32260
11868	3-1/16	3840	109	100	3164 / 32260
11869	3-1/8	3960	111	100	3164 / 32260
11870	3-1/4	4186	115	100	3164 / 32260
11871	3-3/8	4289	118	100	3164 / 32260
11872	3-1/2	4486	123	107	3164 / 32260
11873	3-5/8	4710	126	107	3164 / 32260
11874	3-3/4	5106	129	107	3164 / 32260

## 1" DR SOCKETS DEEP AF

11950-11986

Code	Standards:		DIN 3121 3129		
	Size (inch)	Weight (grams)	Diameter (mm)	Length (mm)	Torque Rating (Nm / kg-cm)
11950	3/4	840	35	90	723 / 7373
11951	13/16	830	41	90	836 / 8525
11952	7/8	820	40	90	949 / 9678
11953	15/16	800	41	90	1062 / 10830
11954	1	880	43	90	1186 / 12097
11955	1-1/16	950	45	90	1321 / 13480
11956	1-1/8	970	48	90	1446 / 14747
11957	1-3/16	1020	49	90	1593 / 16245
11958	1-1/4	1007	51	90	1740 / 17743
11959	1-5/16	1008	53	90	1886 / 19240
11960	1-3/8	1015	55	90	2033 / 20738
11961	1-7/16	1050	58	90	2203 / 22466
11962	1-1/2	1099	59	90	2372 / 24195
11963	1-9/16	1140	61	90	2485 / 25347
11964	1-5/8	1160	63	90	2711 / 27651
11965	1-11/16	1270	57	90	2937 / 29955
11966	1-3/4	1340	67	93	3050 / 31107
11967	1-13/16	1500	69	100	3164 / 32260
11968	1-7/8	1550	72	100	3164 / 32260
11969	1-15/16	1560	73	100	3164 / 32260
11970	2	1650	75	100	3164 / 32260
11971	2-1/16	1730	76	100	3164 / 32260
11972	2-1/8	1750	76	100	3164 / 32260
11973	2-3/16	1900	82	105	3164 / 32260
11974	2-1/4	1980	83	105	3164 / 32260
11975	2-5/16	2100	85	105	3164 / 32260
11976	2-3/8	2450	86	120	3164 / 32260
11977	2-7/16	2620	91	120	3164 / 32260
11978	2-1/2	2650	94	120	3164 / 32260
11979	2-9/16	2780	93	121	3164 / 32260
11980	2-5/8	2940	95	120	3164 / 32260
11981	2-3/4	3230	99	125	3164 / 32260
11982	2-7/8	4320	103	123	3164 / 32260
11983	2-15/16	4370	105	126	3164 / 32260
11984	3	4400	106	125	3164 / 32260
11985	3-1/16	4440	109	125	3164 / 32260
11986	3-1/8	4530	109	125	3164 / 32260



11950-11986

# 7. Impacta Sockets



11824-11826

## 1" DR SOCKETS SQUARE METRIC

11824-11826

Code	Standards:		DIN 3121 3129		
	Size (mm)	Weight (grams)	Diameter (mm)	Length (mm)	Torque Rating (Nm / kg-cm)
11824	17	570	54	58	885 / 9030
11825	19	580	54	58	886 / 9030
11826	21	590	54	58	979 / 9979



11827-11829

## 1" DR SOCKETS SQUARE AF

11827-11829

Code	Standards:		DIN 3121 3129		
	Size (inch)	Weight (grams)	Diameter (mm)	Length (mm)	Torque Rating (Nm / kg-cm)
11827	11/16	565	54	58	610 / 6221
11828	3/4	580	54	58	723 / 7373
11829	13/16	585	54	58	836 / 8525



118019-118032

## 1" DR SOCKETS IN-HEX METRIC

118019-118032

Code	Standards:		DIN 3121 3129		
	Size (mm)	Diameter (mm)	Length (mm)	Torque Rating (Nm / kg-cm)	
118019	19	54	100	1400	
118022	22	54	100	2100	
118024	24	54	100	2700	
118027	27	54	100	-	
118030	30	54	100	-	
118032	32	54	100	-	



118075-118085

## 1" DR SOCKETS IN-HEX AF

118075-118085

Code	Standards:		DIN 3121 3129		
	Size (inch)	Diameter (mm)	Length (mm)	Torque Rating (Nm / kg-cm)	
118075	3/4	54	100	1400	
118080	7/8	54	100	2100	
118085	1	54	100	2700	



11808

## 1" DR UNIVERSAL JOINT

11808

Code	Standards:		DIN 3121 3129	
	Size (inch)	Weight (grams)	Diameter (mm)	Length (mm)
11808	1	1380	54	130

Limited 12 month warranty. Should only be used at a maximum angle of 30° to prevent potential failure.



**1" DR EXTENSIONS**

11812-11817

Code	Standards:		DIN 3121 3129	
	Size (mm)	Weight (grams)	Diameter (mm)	Torque Rating (Nm / kg-cm)
11812	150	1179	52	2516 / 25663
11815	250	1883	54	2516 / 25663
11817	375	2720	54	2515 / 25645



11812-11817

**1" DR PINS & "O" RINGS**

11820-11823

Code	Description
11820	17mm to 70mm "O" Ring
11821	75mm to 90mm "O" Ring
11822	17mm to 70mm Pin
11823	75mm to 90mm Pin



11820-11823

Pins and "O" Rings are used to retain extensions to impact wrench and sockets to extensions on 1" Drive.

**1" & 1-1/2" DR ADAPTORS**

11809-11811

Code	Standards:		DIN 3121 3129		
	Size	Weight (grams)	Diameter (mm)	Length (mm)	Torque Rating (Nm / kg-cm)
11809	1" F to 3/4" M	660	54	71	1413 / 14408
11810	1" F to 1-1/2" M	960	54	90	1912 / 19500
11811	1-1/2" F to 1" M	2220	86	100	427 / 4354



11809-11811

11810

**1-1/2" DR SOCKETS METRIC**

112030-112155

Code	Size (mm)	Diameter (mm)	Length (mm)	Torque Rating (Nm / kg-cm)
112030	30	54	67	2203 / 22467
112032	32	56	67	2203 / 22467
112036	36	62	78	2203 / 22467
112038	38	65	78	2203 / 22467
112041	41	68	80	-
112046	46	74	84	-
112050	50	79	84	3841 / 39173
112055	55	86	90	-
112060	60	92	90	5197 / 52999
112065	65	98	95	-
112070	70	104	100	-
112075	75	108	105	5423 / 55303
112080	80	115	110	5423 / 55303
112085	85	122	112	-
112090	90	128	112	-
112095	95	135	112	-
112100	100	140	125	-
112105	105	148	125	-
112110	110	154	125	-
112115	115	160	135	-
112120	120	166	135	-
112125	125	172	135	-
112130	130	178	140	-
112135	135	184	145	-
112140	140	190	150	-
112145	145	196	155	-
112150	150	202	160	-
112155	155	214	165	-



112030-112155

# 7. Impacta Sockets

## 1-1/2" DR STANDARD SOCKETS AF

111000-111245

Code	Standards:		ANSI	
	Size (inch)	Weight (kg)	Diameter (mm)	Length (mm)
111000	1	-	-	-
111005	1-1/16	-	-	-
111010	1-1/8	-	-	-
111015	1-3/16	1.98	56	78
111020	1-1/4	2.06	58	78
111025	1-5/16	2.12	60	78
111030	1-3/8	2.16	62	78
111035	1-7/16	2.3	64	78
111040	1-1/2	2.17	66	78
111045	1-9/16	2.26	68	78
111050	1-11/16	2.31	71	80
111055	1-3/4	2.51	75	84
111060	1-13/16	2.55	76	84
111065	1-7/8	2.52	78	84
111070	2	2.44	82	87
111075	2-1/16	2.39	83	87
111080	2-3/16	2.49	86	90
111085	2-1/4	2.47	86	92
111090	2-5/16	2.82	92	92
111095	2-3/8	2.76	93	95
111100	2-7/16	3.1	96	95
111105	2-1/2	3.1	97	95
111110	2-9/16	3.09	97	100
111115	2-5/8	3.64	103	100
111120	2-11/16	3.72	104	103
111125	2-3/4	3.65	105	103
111130	2-7/8	3.86	108	103
111135	2-13/16	3.81	108	103
111140	2-15/16	3.96	110	110
111145	3	3.89	110	118
111150	3-1/8	4.53	116	118
111155	3-3/8	5.39	125	118
111160	3-1/2	5.77	130	118
111170	3-5/8	6.2	134	125
111180	3-3/4	6.52	137	125
111190	3-7/8	7.09	142	125
111200	4	7.3	145	125
111210	4-1/8	7.79	150	125
111220	4-1/4	7.44	153	125
111225	4-3/8	8.6	160	125
111230	4-1/2	8.97	163	135
111235	4-5/8	9.42	165	135
111240	4-3/4	9.23	168	135
111245	5	10.8	179	140



111000-111245

## 1-1/2" DR SOCKETS DEEP METRIC

113080-113115

Code	Standards:		ANSI	
	Size (mm)	Weight (kg)	Diameter (mm)	Length (mm)
113080	80	8.6	115	165
113100	100	14.1	140	185
113115	115	20.9	160	195



113080-113115  
112305-112315

## 1-1/2" DR SOCKETS DEEP AF

112305-112315

Code	Standards:		ANSI	
	Size (inch)	Weight (kg)	Diameter (mm)	Length (mm)
112305	2-1/4	3.93	86	150
112310	3	8.5	110	170
112315	3-1/8	8.5	116	170

**3/8" & 1/2" DR CROWS FOOT SET 15PC** 11221

Code	Size (mm)	Code	Size (mm)	Code	Size (mm)
<b>3/8" Drive:</b>					
112209	8	112213	12	112217	16
112210	9	112214	13	112218	17
112211	10	112215	14	112219	18
112212	11	112216	15	112220	19
<b>1/2" Drive:</b>					
112221	21	112222	22	112223	24

Metric set. Packaged in a blow moulded storage case.



11221

**3/8" & 1/2" DR CROWS FOOT SET 12PC** 11220

Code	Size (inch)	Code	Size (inch)	Code	Size (inch)
<b>3/8" Drive:</b>					
112201	5/16	112204	1/2	112207	11/16
112202	3/8	112205	9/16	112208	3/4
112203	7/16	112206	5/8	-	-
<b>1/2" Drive :</b>					
112238	13/16	112240	15/16	112241	1
112239	7/8	-	-	-	-

AF set. Packaged in a blow moulded storage case.



11220

**1/2" DR CROWS FOOT SET 14PC** 11317

Code	Size (mm)	Code	Size (mm)	Code	Size (mm)
112224	27	112229	34	112234	43
112225	29	112230	35	112235	46
112226	30	112231	36	112236	48
112227	32	112232	38	112237	50
112228	33	112233	41	-	-

Metric set. Packaged in a blow moulded storage case.



11317

**1/2" DR CROWS FOOT SET 14PC** 11318

Code	Size (inch)	Code	Size (inch)	Code	Size (inch)
112242	1-1/16	112247	1-3/8	112252	1-3/4
112243	1-1/8	112248	1-7/16	112253	1-13/16
112244	1-3/16	112249	1-1/2	112254	1-7/8
112245	1-1/4	112250	1-5/8	112255	2
112246	1-5/16	112251	1-11/16	-	-

AF set. Packaged in a blow moulded storage case.



11318



# 7. Impacta Sockets

## 3/8" DR CROWS FOOT SPANNERS METRIC 112209-112220



112209-112220

Standards:	DIN 3121 3129	
Code	Size (mm)	Torque Rating (Nm)
112209	8	202
112210	9	202
112211	10	202
112212	11	202
112213	12	202
112214	13	202
112215	14	202
112216	15	202
112217	16	202
112218	17	202
112219	18	202
112220	19	202

## 3/8" DR CROWS FOOT SPANNERS AF 112201-112208



112201-112208

Standards:	DIN 3121 3129	
Code	Size (inch)	Torque Rating (Nm)
112201	5/16	202
112202	3/8	202
112203	7/16	202
112204	1/2	202
112205	9/16	202
112206	5/8	202
112207	11/16	202
112208	3/4	202

## 1/2" DR CROWS FOOT SPANNERS METRIC 112221-112237



112221-112237

Standards:	DIN 3121 3129	
Code	Size (mm)	Torque Rating (Nm)
112221	21	512
112222	22	512
112223	24	512
112224	27	513
112225	29	513
112226	30	513
112227	32	513
112228	33	513
112229	34	513
112230	35	513
112231	36	513
112232	38	513
112233	41	513
112234	43	513
112235	46	513
112236	48	513
112237	50	513

**1/2" DR CROWS FOOT SPANNERS AF**

112238-112255

Standards:		DIN 3121 3129	
Code	Size (inch)		Torque Rating (Nm)
112238	13/16		512
112239	7/8		512
112240	15/16		512
112241	1		512
112242	1-1/16		513
112243	1-1/8		513
112244	1-3/16		513
112245	1-1/4		513
112246	1-5/16		513
112247	1-3/8		513
112248	1-7/16		513
112249	1-1/2		513
112250	1-5/8		513
112251	1-11/16		513
112252	1-3/4		513
112253	1-13/16		513
112254	1-7/8		513
112255	2		513



112238-112255



## 8. Pliers

**Pliers that  
give you  
total control  
and serious  
grip.**





KC Tools offers a range of heavy duty, multi-purpose pliers that have you really get a grip on anything. Designed to prevent slippage our pliers have been product tested meeting professional Australian quality standards. Our pliers enable you to get a firm grip at any angle and are designed with the comfort of the user in mind providing greater leverage while preventing pinching and slippage.



# 8. Pliers



17350-17352

## COMBINATION PLIERS

17350-17352

Standards:		DIN 5746
Code	Description	Length (mm)
17350	Combination Pliers	150
17351	Combination Pliers	180
17352	Combination Pliers	200

Light insulation. Cutting force 1.6 / 580N. Single joint. Cutting edge hardness 58HRC UP. CR-V, anti-rust coating.



17350H-17352H

## COMBINATION PLIERS HEAVY GRIP

17350H-17352H

Standards:		DIN 5746
Code	Description	Length (mm)
17350H	Combination Pliers Heavy Grip	150
17351H	Combination Pliers Heavy Grip	180
17352H	Combination Pliers Heavy Grip	200

Heavy insulation. Cutting force 1.6 / 580N. Single joint. Cutting edge hardness 58HRC UP. CR-V, anti-rust coating.



17360-17361

## LONG NOSE PLIERS

17360-17361

Standards:		DIN 5745
Code	Description	Length (mm)
17360	Long Nose Pliers	150
17361	Long Nose Pliers	200

Light insulation. Cutting force 1.6 / 580N. Single joint. Cutting edge hardness 58HRC UP. CR-V, anti-rust coating.



17360H-17361H

## LONG NOSE PLIERS HEAVY GRIP

17360H-17361H

Standards:		DIN 5745
Code	Description	Length (mm)
17360H	Long Nose Pliers Heavy Grip	150
17361H	Long Nose Pliers Heavy Grip	200

Heavy insulation. Cutting force 1.6 / 580N. Single joint. Cutting edge hardness 58HRC UP. CR-V, anti-rust coating.



17390-17391

## BENT NOSE PLIERS

17390-17391

Standards:		DIN 5745
Code	Description	Length (mm)
17391	45° Bent Nose Pliers	200

Light insulation. Cutting force 1.6 / 580N. Single joint. Cutting edge hardness 58HRC UP. CR-V, anti-rust coating.



17370-17372

## DIAGONAL CUTTERS

17370-17372

Standards:		DIN 5749
Code	Description	Length (mm)
17370	Diagonal Cutters	150
17371	Diagonal Cutters	180
17372	Diagonal Cutters	200

Light insulation. Single joint. Cutting edge hardness 58HRC UP. CR-V, anti-rust coating.

17370: 1.6 / 460N Cutting force.

17371 & 17372: 1.6 / 580N Cutting force.

**DIAGONAL CUTTERS HEAVY GRIP** 17370H-17372H

Standards:		DIN 5749
Code	Description	Length (mm)
17370H	Diagonal Cutters Heavy Grip	150
17371H	Diagonal Cutters Heavy Grip	180
17372H	Diagonal Cutters Heavy Grip	200

Heavy insulation. Cutting force 1.6 / 460N. Single joint. Cutting edge hardness 58HRC UP. CR-V, anti-rust coating.



17370H-17372H

**END CUTTING PLIERS** 17373

Standards:		DIN 5748
Code	Description	Length (mm)
17373	End Cutting Pliers	200

Single joint. Cutting force 1.6/580N. Cutting edge hardness 58HRC UP. CR-V, anti-rust coating.



17373

**1000V COMBINATION PLIERS** 17610

Standards:		DIN 5748
Code	Description	Length (mm)
17610	Combination pliers	200

Handle insulation meets all the requirements of the VDE standard and relevant international standards (IEC 60900).



17610

**1000V LONG NOSE PLIERS** 17612

Standards:		DIN 5748
Code	Description	Length (mm)
17612	Long Nose Pliers	200

Handle insulation meets all the requirements of the VDE standard and relevant international standards (IEC 60900).



17612

**1000V SIDE CUTTERS** 17614

Standards:		DIN 5748
Code	Description	Length (mm)
17614	Diagonal Cutters	150

Handle insulation meets all the requirements of the VDE standard and relevant international standards (IEC 60900).



17614

**1000V DIAGONAL CUTTERS** 17616

Standards:		DIN 5748
Code	Description	Length (mm)
17616	Diagonal Cutters	200

Handle insulation meets all the requirements of the VDE standard and relevant international standards (IEC 60900).



17616



# 8. Pliers



17400

## MINI COMBINATION PLIERS

17400

Code	Description	Length (mm)
17400	Mini Combination Pliers	125

Body hardness 43HRC UP. Joint rivet hardness 30HRC UP. S45C, satin finish.



17401

## MINI LONG NOSE PLIERS

17401

Standards:		DIN 9655
Code	Description	Length (mm)
17401	Mini Long Nose Pliers	125

Body hardness 43HRC UP. Joint rivet hardness 30HRC UP. S45C, satin finish.



17402

## MINI DIAGONAL CUTTING PLIERS

17402

Standards:		DIN 9655
Code	Description	Length (mm)
17402	Mini Diagonal Cutting Pliers	115

Body hardness 43HRC UP. Joint rivet hardness 30HRC UP. S45C, satin finish.



17403

## MINI FLAT NOSE PLIERS

17403

Standards:		DIN 9655
Code	Description	Length (mm)
17403	Mini Flat Nose Pliers	125

Body hardness 43HRC UP. Joint rivet hardness 30HRC UP. S45C, satin finish.



17404

## MINI BENT NOSE PLIERS

17404

Code	Description	Length (mm)
17404	Mini Bent Nose Pliers	125

45° bent nose. Body hardness 43HRC UP. Joint rivet hardness 30HRC UP. S45C, satin finish.

**MINI END CUTTING PLIERS** 17405

Code	Description	Length (mm)
17405	Mini End Cutting Pliers	115

Body hardness 43HRC UP. Joint rivet hardness 30HRC UP. S45C, satin finish.



17405

**LONG NOSE PLIERS STRAIGHT** 17500-17503

Standards:		DIN 5745
Code	Description	Length (mm)
17500	Long Nose Pliers	275
17503	Long Nose Pliers	400

Body hardness 45HRC UP. Joint rivet hardness 35HRC UP. CR-V, anti-rust. 0° angled gripping jaw.



17500-17503

**LONG NOSE PLIERS 45° BENT** 17501-17504

Code	Description	Length (mm)
17501	Long Nose Pliers	275
17504	Long Nose Pliers	400

Body hardness 45HRC UP. Joint rivet hardness 35HRC UP. CR-V, anti-rust. 45° angled gripping jaw.



17501-17504

**LONG NOSE PLIERS 90° BENT** 17502-17505

Code	Description	Length (mm)
17502	Long Nose Pliers	275
17505	Long Nose Pliers	400

Body hardness 45HRC UP. Joint rivet hardness 35HRC UP. CR-V, anti-rust. 90° angled gripping jaw.



17502-17505

**MULTIGRIP PLIERS CURVED JAW** 17380

Standards:		DIN 8976	
Code	Description	Maximum Opening (mm)	Length (mm)
17380	Multigrip Pliers Curved Jaw	41.4	250

Curved slip jaw. Body hardness 43HRC UP. CR-V, anti-rust coating.



17380

**MULTIGRIP PLIERS STRAIGHT JAW** 17385-17388

Standards:		DIN 8976	
Code	Description	Maximum Opening (mm)	Length (mm)
17385	Straight Jaw Heavy Duty	28.35	250
17386	Straight Jaw Heavy Duty	52.6	300
17387	Straight Jaw Heavy Duty	87.2	400
17388	Straight Jaw Heavy Duty	137	500

Curved slip jaw. Body hardness 43HRC UP. Joint rivet hardness 45 - 60HRC UP. CR-V, anti-rust coating.



17385-17388

# 8. Pliers



17470

## Wheel Balancing Pliers

17470

Code	Description	Length (mm)
17470	Wheel Balancing Pliers	250



17511

## 4 POINT GRIPPING PLIERS

17511

Code	Description	Length (mm)
17511	4 Point Gripping Pliers	200



17520

## HOSE PLIERS

17520

Code	Description	Length (mm)
17520	Hose Pliers	275



17550

## WIRE ROPE CUTTING PLIERS

17550

Code	Description	Length (mm)
17550	Wire Rope Cutting Pliers	180

Cutting capacity 5mm (3/16") wire rope and 1.6mm (1/16") spring wire. Cutting edge hardness 60 ±3 HRC. CR-V, anti-rust.



17450 - 17451

## WIRE TWISTING PLIERS

17450-17451

Code	Description	Length (mm)
17450	Wire Twisting Pliers	150
17451	Wire Twisting Pliers	225

Used in aero, defence and racing industries for wire locking nuts in safety critical applications. Manufactured from CR-V hardened tempered, chrome plated spiral screw assembly and polished faces. Fast twist wire links, securing assemblies subjected to vibration. Side cutter stainless and inconel wire. Slim nose tip for optimum manoeuvrability. Jaw hardness 50-55HRC UP.



17600

## TRIMMING PLIERS

17600

Code	Description	Length (mm)
17600	Trimming Pliers	350

Body hardness 43HRC UP. Joint rivet hardness 30HRC UP. Jaw hardness 30HRC UP. CR-V, anti-rust coating.



10636

## CRIMPING TOOL KIT

10636

Code	Description	Length (mm)
10636	Crimping Tool Kit	240

Cushioned grip pliers with 100 assorted terminals. Made from steel 60 - 75 HRC.



**CRIMPING TOOL & STRIPPER**

10639

Code	Description	Length (mm)	Sizes
10639	Multi-functioning Crimping Tool & Stripper	245	M2.6 - M5

Professional quality. Crimps insulated and non insulated terminals. Strips 6 sizes and includes a wire cutter.



10639

**CRIMPING PLIERS**

10638

Code	Description	Length (mm)	Weight (grams)
10638	Crimping Pliers	215	512

High power crimping ideal for insulated terminals. Made from carbon steel HRC 42 - 48.



10638

**AUTOMATIC WIRE STRIPPER**

10635

Code	Description	Length (mm)
10635	Automatic Wire Stripper	215

Strips, cuts and crimps including ribbon and co-ax cable.



10635

**MIG WELDING PLIERS**

08234

Standards:		DIN 5746
Code	Description	Length (mm)
08234	Mig Welding Pliers	215



08234

**FENCING PLIERS**

17601-17602

Code	Description	Length (mm)
17601	Fencing Pliers	260
17602	Fencing Pliers	330



17601-17602

**MINI CIRCLIP PLIERS SET 80mm 4PC**

17150

Code	Description	Capacity (mm)	Length (mm)
17150	4 Piece Circlip Pliers Set Electronic	3 - 10	140

Parallel tip. Internal and external bent and straight. Spring loaded. Red handles external, black handles internal.



17150



# 8. Pliers

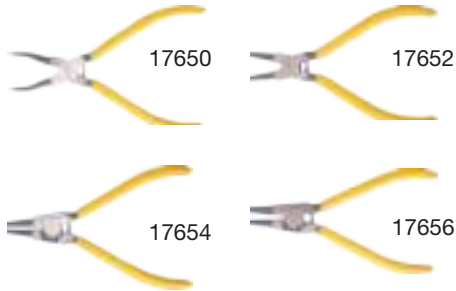

## CIRCLIP PLIERS 140MM & SET

Standards:		DIN 5256/5254		
Set Code	Description	Capacity (mm)		
17658	4 Piece Circlip Pliers Set	3 - 10mm		
Code	Description	Capacity (mm)	Length (mm)	
17650	Internal Straight Circlip Pliers	3 - 10	140	
17652	External Straight Circlip Pliers	3 - 10	140	
17654	Internal Bent Circlip Pliers	3 - 10	140	
17656	External Bent Circlip Pliers	3 - 10	140	

Parallel tip. Circlip pliers will easily remove or install a circlip or snap ring. There are two basic types of circlips and circlip pliers. Internal and External. This refers to whether they are fitted into a "tube" or over a "shaft". Circlips are often used to secure pinned connection.

## CIRCLIP PLIERS 140MM & SET

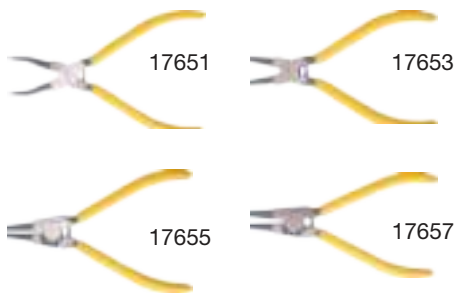

Standards:		DIN 5256/5254		
Set Code	Description	Capacity (mm)		
17659	4 Piece Circlip Pliers Set	8 - 25mm		
Code	Description	Capacity (mm)	Length (mm)	
17651	Internal Straight Circlip Pliers	8 - 25	140	
17653	External Straight Circlip Pliers	8 - 25	140	
17655	Internal Bent Circlip Pliers	8 - 25	140	
17657	External Bent Circlip Pliers	8 - 25	140	

Parallel tip. Circlip pliers will easily remove or install a circlip or snap ring. There are two basic types of circlips and circlip pliers. Internal and External. This refers to whether they are fitted into a "tube" or over a "shaft". Circlips are often used to secure pinned connections.



**CIRCLIP PLIERS 180MM & SET**

Standards:		DIN 5256/5254	
Set Code	Description	Capacity (mm)	
17674	4 Piece Circlip Pliers Set	19 - 60mm	
Code	Description	Capacity (mm)	Length (mm)
17670	Internal Straight Circlip Pliers	19 - 60	180
17671	External Straight Circlip Pliers	19 - 60	180
17672	Internal Bent Circlip Pliers	19 - 60	180
17633	External Bent Circlip Pliers	19 - 60	180

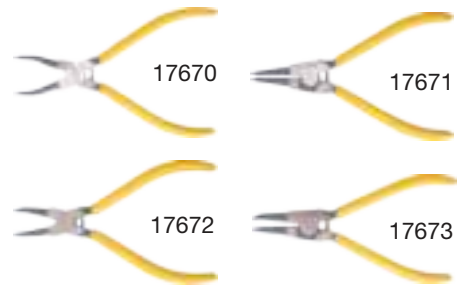

Parallel tip. Circlip pliers will easily remove or install a circlip or snap ring. There are two basic types of circlips and circlip pliers. Internal and External. This refers to whether they are fitted into a "tube" or over a "shaft". Circlips are often used to secure pinned connection.

**CIRCLIP PLIERS 230MM & SET**

Standards:		DIN 5256/5254	
Set Code	Description	Capacity (mm)	
17694	4 Piece Circlip Pliers Set	40 - 100mm	
Code	Description	Capacity (mm)	Length (mm)
17690	Internal Straight Circlip Pliers	40 - 100	230
17691	External Straight Circlip Pliers	40 - 100	230
17692	Internal Bent Circlip Pliers	40 - 100	230
17693	External Bent Circlip Pliers	40 - 100	230

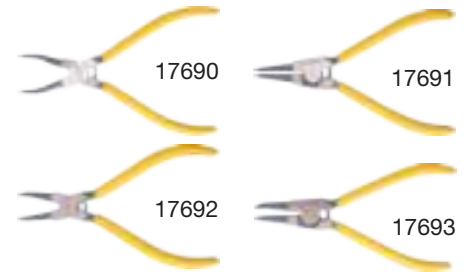

Parallel tip. Circlip pliers will easily remove or install a circlip or snap ring. There are two basic types of circlips and circlip pliers. Internal and External. This refers to whether they are fitted into a "tube" or over a "shaft". Circlips are often used to secure pinned connections.

**CIRCLIP PLIERS SET 10PC**

10626

Code	Description			Length (mm)
10626	10 Piece Circlip Pliers Set			270
Size	Size	Size	Size	
2 0.108"	2 0.108"	2 0.120"	2 0.120"	
0° Tips	45° Tips	0° Tips	45° Tips	
2 0.108"	2 0.108"	2 0.120"	2 0.120"	
15° Tips	90° Tips	15° Tips	90° Tips	
<b>Accessories:</b>			2 Handles	

With interchangeable tips. Spring ratchet mechanism to hold circlip securely against tension.



10626



# 8. Pliers

## CIRCLIP PLIERS SET 4PC

10630

Code	Capacity (mm)	Handle Length (mm)	Head Length (mm)
10630	4 - 26	135	63

With 4 interchangeable tips. Parallel tip internal and external bent and straight. Spring loaded, insulated handles.



10630

## SNAP RING PLIERS SET 10PC

10629

Size	Size	Size
5.5" Bent 1mm Tip	7.5" Bent 1.8mm Tip	5" Hook Tool
6" Straight 1mm Tip	8" Straight 1.8mm Tip	5" Pick Tool
5.5" Bent 1.2mm Tip	8.5" Bent 2.3mm Tip	-
6" Straight 1.2mm Tip	9" Straight 2.3mm Tip	-



10629

## LOCK RING PLIERS

17100-17105

Code	Description	Opening (mm)	Length (mm)
17100	Straight Tip Lock Ring Pliers	38	225
17105	Angle Tip Lock Ring Pliers	38	225

External action pliers which spread snap lock springs used on brakes, transmissions, pedal and clutch shafts and also machine tools. Drop forged from alloy steel. Jaws have deep serrations on the outside of tip to hold lock rings in place.



17100



17105

## LOCKING PLIERS

17024

Code	Description	Length (mm)
17024	Locking Pliers	250

Curve jaw locking pliers grip and holds square and rounded objects. CR-V.



17024

## LOCKING PLIERS

17018-17019

Code	Description	Length (mm)
17018	Locking Pliers	125
17019	Locking Pliers	175

Curve jaw locking pliers grip and holds square and rounded objects. CR-V.



17018



17019



17031

**LOCKING PLIERS**

17031

Code	Description	Length (mm)
17031	Locking Pliers	250

Curved jaws with cutter, drop forged CR-V steel, nickel plated, heat treated and hardened. Holds objects for easy and safe working.



17033

**LOCKING PLIERS**

17033

Code	Description	Length (mm)
17033	Locking Pliers	250

Straight jaws with cutter, drop forged CR-V steel, nickel plated, heat treated and hardened. For secure clamping, holding and gripping. Holds objects for easy and safe working.



17026 - 17027

**LONG NOSE LOCKING PLIERS**

17026-17027

Code	Description	Length (mm)
17027	Long Nose Locking Pliers	150
17026	Long Nose Locking Pliers	230

Long nose locking pliers with cutter, drop forged CR-V steel, nickel plated, heat treated and hardened. Holds objects for easy and safe working.



17036

**C CLAMP LOCKING PLIERS**

17036

Code	Description	Length (mm)
17036	C Clamp Locking Pliers	280

Jaws open to 95mm. CR-V.



17037

**C CLAMP LOCKING PLIERS**

17037

Code	Description	Length (mm)
17037	C Clamp Flex Head Locking Pliers	280

Jaws open to 95mm. CR-V. Flexible tips.



17038

**C CLAMP LOCKING PLIERS**

17038

Code	Description	Length (mm)
17038	C Clamp Long Reach Locking Pliers	460

Jaws open to 175mm. CR-V.

# 8. Pliers

## C CLAMP LOCKING PLIERS

17040

Code	Description	Length (mm)
17040	C Clamp Long Reach Flex Head Locking Pliers	460

Jaws open to 175mm. CR-V. Flexible tips.



17040

## WELDING CLAMP LOCKING PLIERS

17046

Code	Description	Length (mm)
17046	Welding Clamp Pliers	230

Locking welding clamp holds workpiece firmly in position for easy and safe working. Use for clamping profile sections when welding.



17046

## SHEET METAL LOCKING PLIERS

17044

Code	Description	Length (mm)
17044	Sheet Metal Clamping Pliers	250

Flat grip for holding sheet metal or workpiece in place for easy working.



17044

## COMBINATION PLIERS

15610

Code	Weight (grams)	Length (mm)	Body HRC	Cutting HRC
15610	439	200	42 - 45	56 - 62

Fully polished, carbon steel with insulated handles, PVC grip. Used for clamping, picking and cutting



15610

## LONG NOSE PLIERS

15612

Code	Weight (grams)	Length (mm)	Body HRC	Cutting HRC
15612	286	200	42 - 45	56 - 62

Fully polished, carbon steel with insulated handles, PVC grip. Used for clamping, picking and cutting



15612

## DIAGONAL CUTTERS

15614

Code	Weight (grams)	Length (mm)	Body HRC	Cutting HRC
15614	250	185	42 - 45	56 - 62

Fully polished, carbon steel with insulated handles, PVC grip. Used for clamping, picking and cutting



15614





15616

**PLIERS SET**

PR13004

Code	Description	Weight (grams)	Length (mm)
15610	Combination Pliers	439	200
15612	Long Nose Pliers	286	200
15614	Diagonal Cutters	250	185

**MULTIGRIPS**

15616

Code	Weight (grams)	Length (mm)	Maximum Opening (mm)	Body HRC	Cutting HRC
15616	459	250	27.35	42 - 45	56 - 62

Groove joint, fully polished, carbon steel with insulated interlocking handles.



10618

**MULTIGRIPS**

10618

Code	Weight (grams)	Length (mm)	Maximum Opening (mm)
10618	1400	400	83.85

Insulated interlocking handles.



15625

**GRIPS SET**

PR13006

Code	Description	Weight (grams)	Length (mm)
15616	Multigrrips	459	250
15625	Locking Pliers	500	250

**LOCKING PLIERS**

15625

Code	Weight (grams)	Length (mm)
15625	500	250

Curved jaw. Made of chrome plated carbon steel.

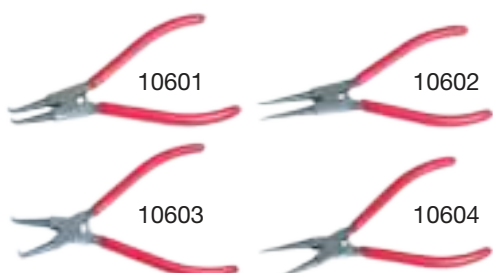

**CIRCLIP PLIERS**

10601-10604

Code	Description	Weight (grams)	Length (mm)
10601	External Bent Circlip Pliers	166	175
10602	External Straight Circlip Pliers	166	175
10603	Internal Bent Circlip Pliers	156	175
10604	Internal Straight Circlip Pliers	156	175

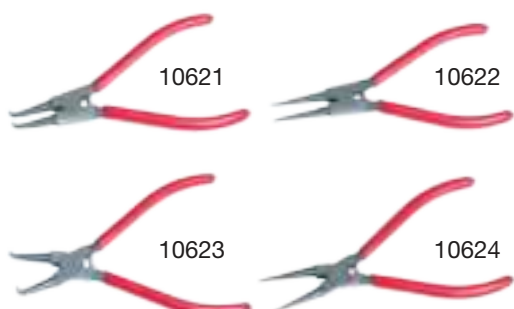

**CIRCLIP PLIERS**

10621-10624

Code	Description	Weight (grams)	Length (mm)
10621	External Bent Circlip Pliers	313	230
10622	External Straight Circlip Pliers	318	230
10623	Internal Bent Circlip Pliers	282	230
10624	Internal Straight Circlip Pliers	302	230

Duckbill.



## 9. Adjustable & Pipe Wrenches



**Adjusting to  
meet changing  
work demands.**







# 9. Adjustable & Pipe Wrenches



A13027-A13033

## ADJUSTABLE WRENCHES

A13027-A13033

Standards:		ANSI B107.8M.1996		
Code	Length (mm)	Weight (grams)	Range (mm)	Torque (kgf-m)
A13027	100	65	0 - 14	7.14
A13028	150	125	0 - 20	16.74
A13029	200	205	0 - 25	30.61
A13030	250	440	0 - 30	52.04
A13031	300	660	0 - 34	87.76
A13032	375	1300	0 - 40	173.47
A13033	450	2000	0 - 43	234.69

Made from CR-V with a hardness of 42 - 48 HRC.



A13035-A13037

## WIDE OPENING WRENCHES

A13035-A13037

Standards:		ANSI B107.8M.1996		
Code	Length (mm)	Weight (grams)	Range (mm)	
A13035	150	180	0 - 34	
A13036	200	280	0 - 38	
A13037	250	540	0 - 50	



15052

## ADJUSTABLE HAMMER WRENCHES

15052

Standards:		ANSI B107.8M.1996		
Code	Description	Size (mm)	Weight (grams)	
15052	Adjustable Hammer Wrench	410	1100	

Versatile wrench fits all nuts and bolts to 380mm (1-1/2"). Eliminates the need for carrying several fixed-size wrenches. Drop forged from select alloy steel with continuous-taper handle. Industrial black phosphate finish. Made from CR-V with a hardness of 40 - 50 HRC.



15120-15126

## PIPE WRENCHES ALUMINIUM

15120-15126

Code	Weight (grams)	Length (mm)	Max Jaw Opening
15120	1000	350	60mm
15122	1670	450	76mm
15124	2670	600	90mm
15126	5000	900	140mm
15128	8500	1200	199mm

Light weight aluminium 'Rigid' pattern.



15130 - 15138

## PIPE WRENCHES STEEL

15130-15138

Code	Weight (grams)	Length (mm)	Max Jaw Opening
15130	1600	350	60mm
15132	2400	450	76mm
15134	4300	600	90mm
15136	8750	900	115mm
15138	14500	1200	166mm

Steel 'Rigid' type pattern.

**HOOK WRENCH SET 3PC**

A13044

Code	Cap Size (mm)	Length (mm)
A13045	19 - 51	165
A13046	32 - 76	216
A13047	51 - 121	267



A13044

**HOOK WRENCHES**

A13045-A13047

Code	Cap Size (mm)	Length (mm)
A13045	19 - 51	165
A13046	32 - 76	216
A13047	51 - 121	267



A13045 - A13047

**ADJUSTABLE WRENCHES**

10517-10582

Code	Length (mm)	Weight (grams)
10576	150	150
10578	200	250
10580	250	450
10582	300	730
10517	375	1500
10518	450	2000
10519	600	3250



10517-10582

Professional grade quality fully polished CR-V. Scale is laser etched into head of adjustables.

**ADJUSTABLE WRENCH SET**

PR13008

Code	Length (mm)	Size (Inch)
10576	150	6
10578	200	8
10582	300	12



PR13008

# 10. Screwdrivers, Hex Keys & Bits

**Precision,  
style and  
performance.**





So you've got that one screw that is just not budging? KC Tools range of high quality screwdrivers, hex keys and bits will get in there and get you out of that tight spot. Our entire range of screwdrivers is designed with magnetic tips and anti-slip handles. The CR-V shafts are precision hardened with tempered tips to give you complete confidence not to strip at the vital moment.

From hex bits, star bits and tamper proof bits to spline bits and adaptors, we guarantee we'll have the right bit for the job. Hex keys are designed for easy accessibility and can be stored in a hard plastic case or the good old folding clip case. The range covers all popular sizes and is made of high quality CR-V or S2 material.

KC Tools screwdrivers, hex keys and bits will handle those awkward screws we are faced with from time to time.



# 10. Screwdrivers, Hex Keys & Bits



16300

## SCREWDRIVER SET 7PC

16300



Standards:		DIN 5264			
Code	Size	Code	Size	Code	Size
<b>Blade:</b>					
16310	3.0 x 75mm	16313	5.5 x 125mm	16319	8.0 x 150mm
16312	4.0 x 100mm	16314	6.5 x 150mm	-	-
<b>Phillips:</b>					
16341	No.1 x 80mm	16343	No.2 x 100mm	-	-

Screwdrivers have a magnetic tip and anti-slip handles. Made with CR-V shafts and precision hardened and tempered tips.



16302

## SCREWDRIVER SET 13PC

16302



Standards:		DIN 5264			
Code	Size	Code	Size	Code	Size
<b>Blade:</b>					
16310	3.0 x 75mm	16314	6.5 x 150mm	16321	6.5 x 25mm
16312	4.0 x 100mm	16315	8.0 x 150mm	-	-
16313	5.5 x 125mm	16316	10 x 200mm	-	-
<b>Phillips:</b>					
16340	No.0 x 60mm	16343	No.2 x 100mm	16345	No.3 x 150mm
16341	No.1 x 80mm	16344	No.2 x 200mm	16350	No.2 x 25mm

Screwdrivers have a magnetic tip and anti-slip handles. Made from CR-V shafts, precision hardened and tempered tips. Comes in a blow moulded plastic storage case.



16305

## SCREWDRIVER SET STAR 8PC

16305



Code	Size	Code	Size	Code	Size
16360	T8 x 60mm	16363	T20 x 100mm	16366	T30 x 115mm
16361	T10 x 80mm	16364	T25 x 100mm	16367	T40 x 130mm
16362	T15 x 80mm	16365	T27 x 115mm	-	-

Screwdrivers have a magnetic tip and anti-slip handles. Made with CR-V shafts and precision hardened and tempered tips.



16306

## SCREWDRIVER SET TAMPERPROOF 8PC

16306



Code	Size	Code	Size	Code	Size
16370	TH8 x 60mm	16373	TH20 x 100mm	16376	TH30 x 115mm
16371	TH10 x 80mm	16374	TH25 x 100mm	16377	TH40 x 130mm
16372	TH15 x 80mm	16375	TH27 x 115mm	-	-

Screwdrivers have a magnetic tip and anti-slip handles. Made with CR-V shafts and precision hardened and tempered tips.

## BLADE SCREWDRIVERS

16310-16327

Standards:		DIN 5264	
Code	Size	Length (mm)	
16310	3.0	75	
16311	3.0	100	
16312	4.0	100	
16313	5.5	125	
16314	6.5	150	
16315	8.0	150	
16316	10.0	200	
16319	8.0	150	
16321	6.5	25	
16323	4.0	100	
16325	6.5	150	
16326	5.0	300	
16327	6.0	300	



16310-16327

Screwdrivers have a magnetic tip and anti-slip handles. Made with CR-V shafts and precision hardened and tempered tips.

## PHILLIPS SCREWDRIVERS

16340-16352

Standards:		DIN ISO8764	
Code	Size	Length (mm)	
16340	No. 0 STD	60	
16341	No. 1 STD	80	
16342	No. 1 STD	200	
16343	No. 2 STD	100	
16344	No. 2 STD	200	
16345	No. 3 STD	150	
16347	No. 2 HEX	100	
16348	No. 3 HEX	150	
16349	No. 1 STD	25	
16350	No. 2 STD	25	
16351	No. 1 STD	300	
16352	No. 2 STD	300	



16340-16352

Screwdrivers have a magnetic tip and anti-slip handles. Made with CR-V shafts and precision hardened and tempered tips.

## STAR SCREWDRIVERS

16360-16367

Code	Size	Length (mm)	
16360	T8	60	
16361	T10	80	
16362	T15	80	
16363	T20	100	
16364	T25	100	
16365	T27	115	
16366	T30	115	
16367	T40	130	



16360-16367

Screwdrivers have a magnetic tip and anti-slip handles. Made with CR-V shafts and precision hardened and tempered tips.

## TAMPERPROOF SCREWDRIVERS

16370-16377

Code	Size	Length (mm)	
16370	TH8	60	
16371	TH10	80	
16372	TH15	80	
16373	TH20	100	
16374	TH25	100	
16375	TH27	115	
16376	TH30	115	
16377	TH40	130	



16370-16377

Screwdrivers have a magnetic tip and anti-slip handles. Made with CR-V shafts and precision hardened and tempered tips.



# 10. Screwdrivers, Hex Keys & Bits



10013

## 10PC HEX BOLSTER SCREWDRIVER SET 10013

Size	Length (mm)	Size	Length (mm)
Blade:			
3.2	75	6	38
5	100	8	150
6	150		
Phillips:			
No. 0	75	No. 2	100
No. 1	75	No. 3	150
No. 2	38		

Hex Bolster Screwdrivers allow you to utilise a spanner or ratchet for tightening and extra torque.

## JUMBO SCREWDRIVER SET 3PC 19011

Standards:		ANSI B107.15 - 2002	
Size	Length (mm)	Weight (grams)	Torque (Nm)
Blade:			
6	440	248	10
10	455	329	28
Phillips:			
No. 2	450	248	14

Fully polished CR-V. HRC 48 - 52.



19011

## PRECISION SCREWDRIVER SET 6PC 16240

Size	Size	Size
Blade:		
2mm	No. 00	T6
3mm	No. 0	T8
4mm	No. 1	T10
-	-	T20

Double ended CR-V screwdrivers. Packaged in a wallet.



16240

## PRECISION SCREWDRIVER SET 6PC 16245

Size	Size
Blade:	
2.0mm	No. 00
2.4mm	No. 0
3.0mm	No. 1

Precision crafted alloy steel, with soft grip and swivel handles for accurate use.



16245

**OFFSET SCREWDRIVER**

16250

Code	Description	Length (mm)
16250	Offset Screwdriver	110
Size		Size
Blade: 5.5		Phillips: No. 2



16250

Handy for tight corners. Anti-slip grip.

**STAR SCREWDRIVER SET 4PC**

10670

Size	Size
T6	T8
T7	T9



10670

**IMPACT DRIVER KIT 8mm SHANK 14PC**

10290

Bit	Size (mm)	Bit	Size (mm)	Bit	Size
Blade	5	Hex	4	Phillips	No.4
Blade	6	Hex	5	Phillips	No.3
Blade	8	Hex	6	Phillips	No.2
Blade	10	Hex	8	Phillips	No.1
Blade	12	-	-	-	-



10290

An impact driver is a hand tool that delivers a strong, impact torque after being struck with a hammer. In conjunction with toughened socket sets, they are often used to loosen larger bolts and nuts that are frozen in place or over-torqued. Impact drivers consist of a heavy outer sleeve that surrounds an inner core that is splined to it. When the user strikes the outer sleeve, its downward force works on the spline to turn the core and any socket or work bit attached to it about 90°. The tool translates the heavy rotational inertia of the sleeve to the lighter core to generate large amounts of torque. Easily loosen screws, nuts, bolts, etc with this hand held impact driver including 13 bits in a plastic case.

**HOOK & PICK SET 4PC**

16390

Code	Description	Length (mm)
16390	4 Piece Hook & Pick Set	135

Contains: 1 Straight tip, 1 90° tip, 1 Hook tip and 1 Combination tip. Removes "O" rings, seals and gaskets. Also useful for cleaning and removing items that are in difficult positions. Points made from CR-V.



16390

# 10. Screwdrivers, Hex Keys & Bits



A13060

## HEX KEY SET 30PC

A13060

Size	Size	Size	Size	Size
0.7mm	3mm	7mm	1/16"	5/32"
0.9mm	4mm	8mm	5/64"	3/16"
1.3mm	4.5mm	10mm	3/32"	7/32"
1.5mm	5mm	0.028"	7/64"	1/4"
2mm	5.5mm	0.035"	1/8"	5/16"
2.5mm	6mm	0.050"	9/64"	3/8"

Long series AF sizes and short series metric sizes. Packaged in a hard plastic case. CR-V.



10613

## 13PC EXTRA LONG METRIC HEX KEY SET

10613

Standards:		DIN2936			
Size (mm)	Torque (Nm)	Size (mm)	Torque (Nm)	Size (mm)	Torque (Nm)
2		6		14	
2.5		7		17	
3		8		19	
4		10			
5		12			

Metric set. Magnatized Tips. Long Series. Turns up to an angle of 25°. For working with hex bolts in difficult positions. Hex keys are made from CR-V with a hardness of HRC 49-53.



10616

## EXTRA LONG BALL POINT HEX KEY SET 9PC

10616

Standards:		DIN2936			
Size (mm)	Torque (Nm)	Size (mm)	Torque (Nm)	Size (mm)	Torque (Nm)
1.5	0.94	3	7.59	6	59.8
2	2.19	4	18.4	8	138
2.5	4.37	5	34.5	10	253

Metric set. Extra long series hex keys. Turns up to an angle of 25°. For working with hex bolts in difficult positions. Hex keys are made from CR-V with a hardness of HRC 49-53.



10615

## 13PC EXTRA LONG AF HEX KEY SET

10615

Size (inch)	Torque (Nm)	Size (inch)	Torque (Nm)	Size (inch)	Torque (Nm)
5/64		7/32		9/16	
3/32		1/4		5/8	
1/8		5/16		3/4	
5/32		3/8			
3/16		1/2			

AF set. Extra long series hex keys. Turns up to an angle of 25°. For working with hex bolts in difficult positions. Hex keys are made from CR-V with a hardness of HRC 49-53.



10617

## EXTRA LONG BALL POINT HEX KEY SET 9PC

10617

Size (inch)	Torque (Nm)	Size (inch)	Torque (Nm)	Size (inch)	Torque (Nm)
1/16	1	1/8	7.7	1/4	57
5/64	2.1	5/32	18	5/16	126
3/32	4.2	3/16	33	3/8	252

AF set. Magnatized Tip. Long Series. Turns up to an angle of 25°. For working with hex bolts in difficult positions. Hex keys are made from CR-V with a hardness of HRC 49-53.



10619

## TAMPER STAR KEY WRENCH SET 9PC

10619

Standards:		CAMCAR			
Size	Torque (Nm)	Size	Torque (Nm)	Size	Torque (Nm)
T10	2.91	T25	12.7	T40	44.4
T15	5.24	T27	18.8	T45	74.4
T20	8.74	T30	25.6	T50	105

Extra long tamper star key wrench set. Hex keys are made from CR-V with a hardness of HRC 49-53.



**T-HANDLE HEX KEY SET 6PC**

A13070

Code	Size (mm)	Code	Size (mm)	Code	Size (mm)
A13072	2.5	A13074	4	A13076	6
A13073	3	A13075	5	A13078	8

Metric set. Ergonomic handle. Key shaft one piece drawn from hexagon bar. Packaged in a plastic blow moulded case.



A13070

**T-HANDLE HEX KEY SET BALL POINT 9PC**

A13080

Code	Size (mm)	Code	Size (mm)	Code	Size (mm)
A130801	2	A130804	4	A130807	8
A130802	2.5	A130805	5	A130808	10
A130803	3	A130806	6	A130809	12

Metric set. Ergonomic handle. Key shaft one piece drawn from hexagon bar. Ball point allows the tool to be used up to a 30° angle. Packaged in a plastic blow moulded case.



A13080

**T-HANDLE HEX KEY SET BALL POINT 9PC**

A13082

Code	Size (inch)	Code	Size (inch)	Code	Size (inch)
A130821	5/64	A130824	5/32	A130827	5/16
A130822	3/32	A130825	3/16	A130828	3/8
A130823	1/8	A130826	1/4	A130829	1/2

AF set. Ergonomic handle. Key shaft one piece drawn from hexagon bar. Ball point allows the tool to be used up to a 30° angle. Packaged in a plastic blow moulded case.



A13082

**T-HANDLE KEY SET 9PC**

A13084

Code	Size	Code	Size	Code	Size
A130841	T10	A130844	T25	A130846	T40
A130842	T15	A130847	T27	A130848	T45
A130843	T20	A130845	T30	A130849	T50

Star and tamperproof set. Ergonomic handle. Key shaft one piece drawn from hexagon bar. Ball point allows the tool to be used up to a 30° angle. Packaged in a plastic blow moulded case.



A13084

# 10. Screwdrivers, Hex Keys & Bits



A13071-A13079

## HEX KEYS

A13071-A13079

Code	Size (mm)	Weight (grams)	Length (mm)
A13071	2	15	140
A13072	2.5	17	140
A13073	3	21	140
A13074	4	34	190
A13075	5	71	210
A13076	6	89	210
A13078	8	156	260
A13079	10	276	280



A130801-A130809

## T-HANDLE BALL END HEX KEYS

A130801-A130809

Code	Size (mm)	Weight (grams)	Length (mm)
A130801	2	15	140
A130802	2.5	17	140
A130803	3	21	140
A130804	4	33	190
A130805	5	71	210
A130806	6	89	210
A130807	8	154	260
A130808	10	275	270
A130809	12	366	270



A130821-A130829

## T-HANDLE BALL END HEX KEYS

A130821-A130829

Code	Size (inch)	Weight (grams)	Length (mm)
A130821	5/64	15	140
A130822	3/32	17	140
A130823	1/8	22	140
A130824	5/32	33	190
A130825	3/16	67	210
A130826	1/4	95	210
A130827	5/16	153	260
A130828	3/8	256	270
A130829	1/2	403	270



A130841-A130849

## TAMPERPROOF & STAR KEYS

A130841-A130849

Code	Size	Weight (grams)	Length (mm)
A130841	T10	27	140
A130842	T15	27	140
A130843	T20	27	145
A130844	T25	83	210
A130847	T27	80	210
A130845	T30	84	210
A130846	T40	144	225
A130848	T45	140	260
A130849	T50	330	280

**BIT SET 10mm SHANK 54PC**

A13390

Code	Size	Code	Size	Code	Size
<b>Hex Bits:</b>					
13700	4mm	13713	3/16"	13719	1/2"
13701	5mm	13714	7/32"	13720	9/16"
13702	6mm	13715	1/4"	13728	10mm
13703	7mm	13716	5/16"	13730	12mm
13704	8mm	13717	3/8"	13732	14mm
13706	10mm	13718	7/16"	13742	1/2"
13708	12mm	13719	1/2"	13743	9/16"
13710	14mm	13720	9/16"	-	-
13712	5/32"	13718	7/16"	-	-
<b>Star Bits:</b>					
13745	T20	13749	T40	13753	T60
13746	T25	13750	T45	13761	T50
13747	T27	13751	T50	13762	T55
13748	T30	13752	T55	13763	T60
<b>Tamperproof Bits:</b>					
13754	T10	13767	T27	13771	T50
13764	T15	13768	T30	13772	T55
13765	T20	13769	T40	13773	T60
13766	T25	13770	T45	-	-
<b>Spline Bits:</b>					
13775	M5	13778	M10	13784	M12
13776	M6	13779	M12	-	-
13777	M8	13783	M10	-	-
<b>Adaptors:</b>					
13790	3/8" Bit Adaptor		13792	1/2" Bit Adaptor	



A13390

Popular sizes of metric and imperial hex, star and tamperproof bits. Packaged in a vacuum formed insert in a metal storage case.

**BIT SET 10mm SHANK 28PC**

A13395

Code	Size	Code	Size	Code	Size
<b>Hex Bits:</b>					
13700	4mm	13708	12mm	13716	5/16"
13701	5mm	13710	14mm	13717	3/8"
13702	6mm	13712	5/32"	13718	7/16"
13703	7mm	13713	3/16"	13719	1/2"
13704	8mm	13714	7/32"	13720	9/16"
13706	10mm	13715	1/4"	-	-
<b>Star Bits:</b>					
13745	T20	13748	T30	13751	T50
13746	T25	13749	T40	13752	T55
13747	T27	13750	T45	13753	T60
<b>Adaptors:</b>					
13790	3/8" Bit Adaptor		13792	1/2" Bit Adaptor	



A13395

Popular sizes of metric and imperial hex bits. Made from high quality CR-V hardened to HRC 50-55. Packaged in a vacuum formed insert in a metal storage case.



# 10. Screwdrivers, Hex Keys & Bits



13700-13710

## HEX BITS 10mm SHANK METRIC

13700-13710

Code	Size (mm)	Length (mm)	Shank (mm)	Torque Standard (Nm)	Weight (grams)
13700	4	30	10	17	14
13701	5	30	10	24	15
13702	6	30	10	59	15
13703	7	30	10	95	16
13704	8	30	10	137	17
13706	10	30	10	245	20
13708	12	30	10	470	24
13710	14	30	10	500	29

Made from high quality CR-V hardened to HRC 50-55.



13712-13720

## HEX BITS 10mm SHANK

13712-13720

Code	Size (inch)	Length (mm)	Shank (mm)	Torque Standard (Nm)	Weight (grams)
13712	5/32	30	10	16	14
13713	3/16	30	10	32	14
13714	7/32	30	10	55	14
13715	1/4	30	10	63	15
13716	5/16	30	10	137	17
13717	3/8	30	10	200	19
13718	7/16	30	10	245	22
13719	1/2	30	10	280	26
13720	9/16	30	10	500	30

Made from high quality CR-V hardened to HRC 50-55.



13722-13732

## HEX BITS 10mm SHANK

13722-13732

Code	Size (mm)	Length (mm)	Shank (mm)	Torque Standard (Nm)	Weight (grams)
13722	4	75	10	16	50
13723	5	75	10	30	50
13724	6	75	10	52	50
13725	7	75	10	78	50
13726	8	75	10	120	50
13728	10	75	10	245	50
13730	12	75	10	470	50
13732	14	75	10	590	50

Made from high quality CR-V hardened to HRC 50-55.



13735-13743

## HEX BITS 10mm SHANK

13735-13743

Code	Size (inch)	Length (mm)	Shank (mm)	Torque Standard (Nm)	Weight (grams)
13735	5/32	75	10	16	50
13736	3/16	75	10	30	50
13737	7/32	75	10	52	50
13738	1/4	75	10	52	50
13739	5/16	75	10	120	50
13740	3/8	75	10	220	50
13741	7/16	75	10	295	50
13742	1/2	75	10	280	50
13743	9/16	75	10	500	50

Made from high quality CR-V hardened to HRC 50-55.

**STAR BITS 10mm SHANK**

13745-13753

Code	Size	Length (mm)	Shank (mm)	Torque Standard (Nm)	Weight (grams)
13745	T20	30	10	12	12
13746	T25	30	10	19	12
13747	T27	30	10	26	13
13748	T30	30	10	37	14
13749	T40	30	10	65	14
13750	T45	30	10	103	15
13751	T50	30	10	158	16
13752	T55	30	10	256	18
13753	T60	30	10	445	21



13745-13753

**STAR BITS 10mm SHANK**

13755-13763

Code	Size	Length (mm)	Shank (mm)	Torque Standard (Nm)	Weight (grams)
13755	T20	75	10	12	50
13756	T25	75	10	18	50
13757	T27	75	10	26	50
13758	T30	75	10	37	50
13759	T40	75	10	65	50
13760	T45	75	10	103	50
13761	T50	75	10	158	50
13762	T55	75	10	256	50
13763	T60	75	10	445	50



13755-13763

**SPLINE BITS 10mm SHANK**

13775-13779

Code	Size	Length (mm)	Shank (mm)	Torque Standard (Nm)	Weight (grams)
13775	M5	30	10	37	13
13776	M6	30	10	65	14
13777	M8	30	10	103	15
13778	M10	30	10	158	17
13779	M12	30	10	256	20



13775-13779

**SPLINE BITS 10mm SHANK**

13780-13784

Code	Size	Length (mm)	Shank (mm)	Torque Standard (Nm)	Weight (grams)
13780	M5	75	10	30	50
13781	M6	75	10	52	50
13782	M8	75	10	120	50
13783	M10	75	10	158	50
13784	M12	75	10	256	50



13780-13784

**TAMPERPROOF BITS 10mm SHANK**

13754-13773

Code	Size	Length (mm)	Shank (mm)	Torque Standard (Nm)	Weight (grams)
13754	T10	30	10	4	12
13764	T15	30	10	7	12
13765	T20	30	10	12	12
13766	T25	30	10	19	13
13767	T27	30	10	26	13
13768	T30	30	10	37	14
13769	T40	30	10	65	14
13770	T45	30	10	103	15
13771	T50	30	10	158	16
13772	T55	30	10	256	18
13773	T60	30	10	445	21



13754-13773

# 10. Screwdrivers, Hex Keys & Bits



10662



## TAMPERPROOF BIT SET 1/4" SHANK 8PC

Standards:				DIN	
Size	Length (mm)	Size	Length (mm)	Size	Length (mm)
T10	30	T25	30	T40	30
T15	30	T27	30	Offset Handle	110
T20	30	T30	30	-	-

## BITS SET 1/4" SHANK 33PC

10664

Bit	Size	Bit	Size	Bit	Size
Hex	2mm	Hex	5/64"	Toro	8mm
Hex	2.5mm	Star	T8	Toro	10mm
Hex	3mm	Star	T10	Spanner	4mm
Hex	4mm	Star	T15	Spanner	6mm
Hex	5mm	Star	T20	Spanner	8mm
Hex	6mm	Star	T25	Spanner	10mm
Hex	5/32"	Star	T27	Tri-Wing	1
Hex	9/64"	Star	T30	Tri-Wing	2
Hex	1/8"	Star	T35	Tri-Wing	3
Hex	7/64"	Star	T40	Tri-Wing	4
Hex	3/32"	Toro	6mm	Adaptor	60mm



10664

## BIT ADAPTORS

13788-13792

Code	Description	Weight (grams)	Length (mm)
13788	1/4" Bit Adaptor	26	12
13790	3/8" Bit Adaptor	28	30
13792	1/2" Bit Adaptor	52	36



13788-13792

## SCREWDRIVER SET 13PC

SD13

Size (mm)	Size (mm)	Size
Blade:	Blade:	Phillips:
8 x 200	5 x 150	No. 3 x 150mm
8 x 150	5 x 100	No. 2 x 100mm
6 x 150	6 x 38	No. 0 x 75mm
6 x 200	3 x 75	No. 2 x 38mm
-	-	No. 1 x 75mm

Magnetic tip. CR-V.



SD13



**PRECISION SCREWDRIVER SET 6PC** 19009

Size (mm)	Size (mm)	Size
Blade:	Blade:	Phillips:
1.0	2.0	No.0
1.4	2.4	No.1



Packaged in a plastic box with hinged lid.



19009

**OFFSET SCREWDRIVER SET 3PC** 10027

Size (mm)	Size
Blade:	Phillips:
5	No.1
6	No.2
8	No.3



Packaged in a plastic box with hinged lid.



10027

**HOOK, PICK & DRIVER SET 8PC** 10419

Code	Description
10419	8 Piece Hook, Pick & Driver Set



4 Hooks and picks, No. 0 Phillips, 3mm Blade & T15 & T20 Star driver. Packaged in a plastic box with hinged lid.



10419

**LONG & STANDARD HEX KEY SET 25PC** 10600

Size	Size	Size	Size	Size
1.5mm	4.5mm	8mm	3/32"	3/16"
2mm	5mm	9mm	7/64"	7/32"
2.5mm	5.5mm	10mm	1/8"	1/4"
3mm	6mm	1/16"	9/64"	5/16"
4mm	7mm	5/64"	5/32"	3/8"



Packaged in a plastic wallet.



10600

# 11. Hammers, Levers & Punches



**Hammers  
that pack a  
punch.**

Our tools are very striking, strikingly good in fact. Knockometers, punches, levers are all manufactured with safety, efficiency and usability in mind. I mean, if you pick up a hammer you are going to make something happen, like your serious about the job at hand and you want that feeling of quality. That is what you get with KC Tools, strikingly good.





# 11. Hammers, Levers & Punches



## BALL PEIN HAMMERS

Code	Weight (grams)	Length (mm)	Striking Face (mm)
14090	225	300	-
14091	350	300	26
14092	450	350	30
14093	650	400	32
14094	900	400	35
14095	1300	410	42

Hickory handles. Made from SAE1055.



15010-15013

## BALL PEIN HAMMERS

15010-15013

Code	Weight (grams)	Length (mm)	Striking Face (mm)
15010	450	310	-
15011	650	340	-
15012	900	360	36
15013	1300	400	-

Polished head with fibre glass handle with rubber grip. Made from carbon steel 50 - 58 HRC.



15020-15022

## CLUB HAMMERS

15020-15022

Code	Weight (grams)	Length (mm)
15020	1350 (3lb)	210
15022	1800 (4lb)	230

Fibre glass handle with a TPR rubber grip and a dural, baked enamel finish. Made from carbon steel 50 - 58 HRC.



15025-15030

## SLEDGE HAMMERS

15025-15030

Code	Weight (grams)	Length (mm)
15025	1350 (3lb)	360
15026	2700 (6lb)	860
15028	3600 (8lb)	900
15029	4500 (10lb)	900
15030	5400 (12lb)	950

Fibre glass handle with a TPR rubber grip and a dural, baked enamel finish. Made from carbon steel 50 - 58 HRC.

## COPPER HAMMERS

15060-15063

Code	Weight (grams)	Length (mm)	Striking Face (mm)
15060	450	335	26.5
15061	650	355	34
15062	900	390	38.5
15063	1300	410	44.5

Double face, solid copper with fibre glass handle with rubber grip.



15060-15063

## SOFT BLOW HAMMER

15070-15070N

Code	Description	Weight (grams)	Length (mm)
15070	Soft Blow Hammer	450	320
15070R	Replacement Rubber Head	23	29
15070A	Replacement Acetate Head	30	29
15070N	Replacement Nylon Head	26	29

Steel shaft with rubber handle. Soft Blow hammers are useful in that they transmit the full force of the blow without damaging the part struck. These hammers are also comparatively noiseless ensuring silence in otherwise noisy workshops where steel against steel is used. Further, they are also non-spark and therefore quite safe to use in situations where there is a fire risk.



15070-15070N

## RUBBER MALLET

10315-10319

Code	Weight (grams)	Length (mm)
10315	225	280
10316	340	310
10317	455	313
10318	680	330
10319	905	350

Hickory handle.



10315-10319

## DEAD BLOW MALLET

15044

Code	Weight (grams)	Length (mm)	Head Diameter (mm)
15044	795	320	50

Steel shaft and handle covered with rubber.



15044

# 11. Hammers, Levers & Punches



A7260

## PUNCH & CHISEL SET 6PC

A7260

Standards:		B107.48M.1998	
Code	Size (mm)	Code	Size (mm)
Punches:		Chisels:	
A7233	No. 6.5	A7252	12
A7203	4	A7254	19
A7205	6	-	-
A7207	8	-	-

CR-V. Phosphate finish. Packaged in a canvas wallet with a velcro fastener.



A7100

## PUNCH & CHISEL SET 7PC

A7100

Standards:		B107.48M.1998	
Code	Size (mm)	Code	Size (mm)
Punches:		Chisels:	
A7233	No. 6.5	A7252	12
A7202	3	A7253	16
A7203	4	-	-
A7204	5	-	-
A7205	6mm	-	-

CR-V. Phosphate finish. Packaged in a canvas wallet with a velcro fastener.



07020

## PUNCH & CHISEL SET 10PC

07020

Standards:		B107.48M.1998	
Size (mm)		Size (mm)	
Punches:		Chisels:	
No.2	4	12	19
3 x 9.5	5	-	-
2	6	-	-
3mm	8	-	-

CR-V. Phosphate finish. Packaged in a canvas wallet with a velcro fastener.



A7200

## LONG SERIES PIN PUNCH SET 8PC

A7200

Standards:		B107.48M.1998			
Code	Size (mm)	Code	Size (mm)	Code	Size (mm)
A7201	2.5	A7204	5	A7207	8
A7202	3	A7205	6	A7208	10
A7203	4	A7206	6.5	-	-

CR-V. Phosphate finish. Packaged in a canvas wallet with a velcro fastener.



A7210

## SHORT SERIES PIN PUNCH SET 7PC

A7210

Standards:		B107.48M.1998			
Code	Size (mm)	Code	Size (mm)	Code	Size (mm)
A7211	2	A7214	4	A7217	6.5
A7212	2.5	A7215	5	-	-
A7213	3	A7216	6	-	-

CR-V. Phosphate finish. Packaged in a canvas wallet with a velcro fastener.



**CENTRE PUNCH SET 5PC**

A7220

Standards:		B107.48M.1998			
Code	Size	Code	Size	Code	Size
A7221	No. 2	A7223	No. 3	A7225	No. 5
A7222	No. 2.5	A7224	No. 4	-	-

CR-V. Phosphate finish. Packaged in a canvas wallet with a velcro fastener.



A7220

**INDUSTRIAL CENTRE PUNCH SET 5PC**

A7230

Standards		B107.48M.1998	
Code	Size	Code	Size
A7224	No. 4	A7234	No. 8
A7225	No. 5	A7235	No. 10
A7233	No. 6.5	-	-

CR-V. Phosphate finish. Packaged in a canvas wallet with a velcro fastener.



A7230

**STARTER DRIFT SET 6PC**

A7240

Standards		B107.48M.1998	
Code	Size (mm)	Code	Size (mm)
A7241	2	A7244	6.5
A7242	3	A7245	8
A7243	5	A7246	10

Also known as Taper Punches. CR-V. Phosphate finish. Packaged in a canvas wallet with a velcro fastener.



A7240

**COLD CHISEL SET 6PC**

A7250

Standards		B107.48M.1998			
Code	Size (mm)	Code	Size (mm)	Code	Size (mm)
A7251	10	A7253	16	A7255	22
A7252	12	A7254	19	A7256	25

CR-V. Phosphate finish. Packaged in a canvas wallet with a velcro fastener.



A7250

# 11. Hammers, Levers & Punches

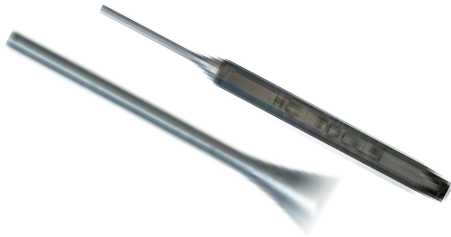

A7201-A7208

## LONG SERIES PIN PUNCHES

A7201-A7208

Standard:		B107.48M.1998		
Code	Size (mm)	Length (mm)	Striking End Diameter (mm)	
A7201	2.5	150		10
A7202	3	150		10
A7203	4	158		10
A7204	5	161		10
A7205	6	163		10
A7206	6.5	167		10
A7207	8	167		13
A7208	10	170		13

CR-V. Phosphate finish. Blister packed.



A7211-A7217

## SHORT PIN PUNCHES

A7211-A7217

Standard:		B107.48M.1998		
Code	Size (mm)	Length (mm)	Striking End Diameter (mm)	
A7211	2	105		10
A7212	2.5	105		10
A7213	3	105		10
A7214	4	106		10
A7215	5	107		10
A7216	6	108		10
A7217	6.5	108		10

CR-V. Phosphate finish. Blister packed.

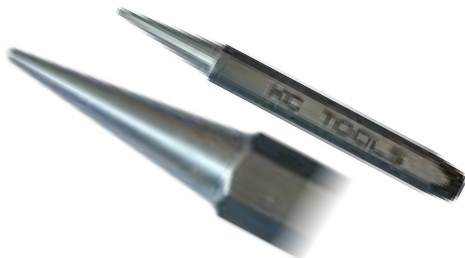

A7221-A7225

## CENTRE PUNCHES

A7221-A7225

Standard:		B107.48M.1998		
Code	Size	Length (mm)	Striking End Diameter (mm)	
A7221	No. 2	101		10
A7222	No. 2.5	101		10
A7223	No. 3	101		10
A7224	No. 4	101		10
A7225	No. 5	101		10

CR-V. Phosphate finish. Blister packed.

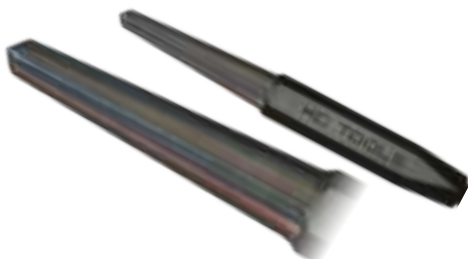

A7233-A7235

## INDUSTRIAL CENTRE PUNCHES

A7233-A7235

Standard:		B107.48M.1998		
Code	Size	Length (mm)	Striking End Diameter (mm)	
A7233	No. 6.5	125		13
A7234	No. 8	150		16
A7235	No. 10	150		16

CR-V. Phosphate finish. Blister packed.

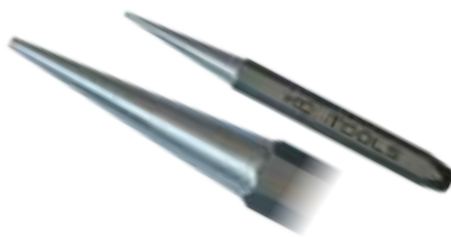

A7241-A7246

## STARTER DRIFTS

A7241-A7246

Standard:		B107.48M.1998		
Code	Size (mm)	Length (mm)	Striking End Diameter (mm)	
A7241	2	113		10
A7242	3	140		10
A7243	5	150		13
A7244	6.5	165		13
A7245	8	180		16
A7246	10	190		16

Also known as Taper Punches. CR-V. Phosphate finish. Blister packed.

**ROOFING PUNCH**

A7229

Code	Length (mm)	Striking End Diameter (mm)	Weight (grams)
A7229	200	15.9	220

CR-V. Phosphate finish. Blister packed.

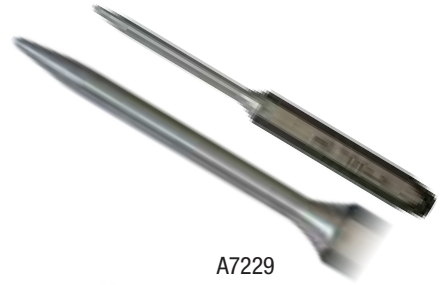

A7229

**BRASS PUNCHES**

07027-07028

Code	Length (inch)	Weight (grams)
07027	8	340
07028	10	604



07027-07028

**COLD CHISELS**

A7251-A7256

Code	Size (mm)	Length (inch)	Striking End Diameter (mm)
A7251	10	140	8
A7252	12	152	10
A7253	16	178	13
A7254	19	190	16
A7255	22	203	16
A7256	25	216	19

CR-V. Phosphate finish. Blister packed.



A7251-A7256





# 11. Hammers, Levers & Punches



07026

## BRASS PUNCH SET 3PC

07026

Size (inch)	Size (inch)	Size (inch)
1/4 x 4	3/8 x 6	1/2 x 8

Non sparking. Packaged in a vacuum formed tray.



08050

## HOLLOW PUNCH SET 12PC

08050

Size (inch)	Size (inch)	Size (inch)
1/8	1/4	1/2
5/32	5/16	9/16
3/16	3/8	5/8
7/32	7/16	3/4

Carbon steel, knurled grip. Packaged in a plastic wallet.



10070-10071

## PUNCH SETS 36PC

10070-10071

Code	Range	Description	Weight (grams)
10070	5mm	36 Piece Letter and Number Punch Set	1800
10071	6mm	36 Piece Letter and Number Punch Set	1820

Used for stamping metal products such as steel plates, sections, sheet metal, tools etc. Made from hardened steel, comes in a neat plastic box. Set includes '&'. 58 - 62 HRC.



10072-10076

## LETTER PUNCH SET 27PC

10072-10076

Code	Range	Description	Weight (grams)
10072	3mm	27 Piece Letter Punch Set	750
10074	5mm	27 Piece Letter Punch Set	820
10076	10mm	27 Piece Letter Punch Set	2500

Used for stamping metal products such as steel plates, sections, sheet metal, tools etc. Made from hardened steel, comes in a neat plastic box. Set includes '&'.



10073-10077

## NUMBER PUNCH SET 9PC

10073-10077

Code	Range	Description	Weight (grams)
10073	3mm	9 Piece Number Punch Set	176
10075	5mm	9 Piece Number Punch Set	281
10077	10mm	9 Piece Number Punch Set	868

Used for stamping metal products such as steel plates, sections, sheet metal, tools etc. Made from hardened steel, comes in a neat plastic box. Set includes '&'. Sets use a 6 as a 9.

**TYRE LEVERS**

07125-07126

Code	Length (mm)	Weight (grams)
07125	380	340
07126	530	950



**ROLLING HEAD PRY BAR SET 4PC**

10700

Code	Size (mm)	Weight (grams)	Code	Size (mm)	Weight (grams)
10696	150	70	10698	400	470
10697	300	240	10699	500	860

Black finish, CR-V. 50 HRC.



**PRY BAR SET 4PC**

08330

Size (mm)	Size (mm)	Size (mm)	Size (mm)
200	300	450	600

Heat treated drop forged steel blades with tough black finish. Heavy duty pro style PVC handles.



**HEAVY DUTY PRY BAR SET 4PC**

08331

Size (mm)	Size (mm)	Size (mm)	Size (mm)
600	650	900	1000

Heavy duty plastic handles. Packaged in a plastic case.

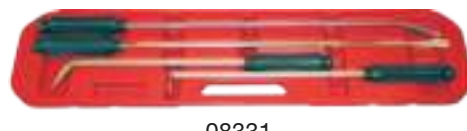

**ROLLING HEAD PRY BARS**

10696-10699

Code	Length (mm)	Width (mm)	Weight (grams)
10696	150	30	70
10697	300	35	240
10698	400	45	470
10699	500	60	860

Black finish, CR-V. 50 HRC.



**ROLLING HEAD PRY BARS**

07121

Code	Length (mm)	Weight (grams)
07121	445	820

A robust tool, ideal for removing bearings, seals, injectors etc. Combined with a tapered aligner.



**PRY BARS**

07118-07119

Code	Length (mm)	Weight (grams)
07118	450	630
07119	615	1210

Podger bars have a curved chisel end and tapered aligner. Hardened and tempered for increased durability.



# 11. Hammers, Levers & Punches



19013

## PUNCH & CHISEL SET 7PC

19013

Description	Length (mm)	Width (mm)	Length (mm)	Width (mm)
Punches:			Chisels:	
Centre Punch	155	5	155	10
Pin Punch	155	4	155	12
Pin Punch	155	6	155	16
Pin Punch	155	8		

Packaged in a wallet.



19015

## PUNCH & CHISEL SET 12PC

19015

Description	Length (mm)	Width (mm)	Length (mm)	Width (mm)
Punches:			Chisels:	
Centre Punch	155	4	170	11
Centre Punch	205	5	180	13
Pin Punch	205	9	205	16
Drift Punch	155	3	205	19
Drift Punch	255	5	255	22
Drift Punch	255	9	255	25

Packaged in a wallet.





## 12. Hacksaws, Cutters & Knives

# Let's cut to the chase.

Professionals recommend our hacksaws because they are solid, comfortable and provide high performance cutting. The range includes the clever 3D, the Deluxe and the Pro all featuring easy grip handles that allow control and accuracy even at those awkward angles.

KC Tools compact cutters and knives feature auto-locking blades, ergonomic handles and retractable blades that also store in the handle. That means safety and convenience for the user. Cutting plastics, cardboard packing or gasket paper can be done quickly and easily.



# 12. Hacksaws, Cutters & Knives

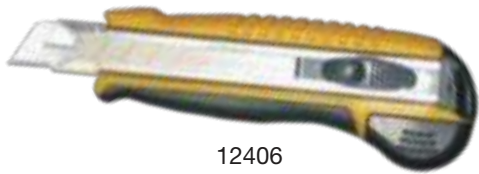

12406

## TRIMMING KNIFE SNAP OFF BLADE

12406

Code	Length (mm)	Blade Height (mm)
12406	165	18

Blade auto-locks. Holds up to 48 snap-off blades. Used for modelling and other uses. Cuts: Plastic, cardboard, gasket paper etc. Suits spare blades 12418.



12404



**SUPERSEDED**  
Page No. 295

## SAFETY RETRACTABLE KNIFE

12404

Code	Length Closed (mm)	Blade Height (mm)
12404	150	45

Automatic retractable blade. For spare blades order 12420



12404-1

## AUTO LOADING UTILITY KNIFE

12404-1

Code	Length Closed (mm)	Blade Height (mm)
12404-1	175	45

Auto loading, 8 spare blades. Zinc body with rubber grip. Suits spare blades 12416.



12114

## AUTO LOADING FOLDING UTILITY KNIFE

12114

Code	Length Open (mm)	Length Closed (mm)	Blade Height (mm)
12114	175	110	45

Sturdy zinc body, blade storage. Easy removal of old blades. Rubber grip. Suits spare blades 12416.



12410

## FOLDING BLADE POCKET KNIFE

12410

Code	Length Open (mm)	Blade Height (mm)
12410	165	105

Aluminium body with rubber grip. Push lock lever for blade release. Stainless blades. Belt clip.



12135

## FOLDING UTILITY KNIFE

12135

Code	Length Open (mm)	Length Closed (mm)	Blade Height (mm)
12135	165	110	45

Plastic body with rubber grip. Suits spare blades 12416.



12416

## TRIMMING KNIFE BLADES 10PC

12416 - 12420

Code	Length (mm)	Blade Height (mm)
12416	62	45
12420	62	45

Contains 10 Blades



12420

**MULTI-PURPOSE GASKET SCISSORS**

17255

Code	Length (mm)	Blade Length (mm)
17255	140	3mm

Hi-tensile stainless steel blades. Ideal for industrial cutting applications.



17255

**GASKET SCRAPER SET 3PC**

08103

Code	Length (mm)	Blade Width (mm)	Weight (grams)
08103	276, 280 & 285	20, 25 & 45	300

Plastic handles. Hardened bevel edged blades for durability. Hardened bevel edged blade for removing old gaskets. Blade can easily be sharpened.



08103

**PRO HACKSAW**

12262

Code	Description	Blade Length (mm)
12262	Pro Hacksaw	300

Rubber handle grip. Quick release wing adjuster. Die cast aluminium frame, rubber grip handle, easy to tension screw on bottom of handle. Blade can be positioned for cutting at 90 and 45° angles. Takes all standard 300mm blades.



12262

**DELUXE HACKSAW**

12265

Code	Description	Blade Length (mm)
12265	Deluxe Hacksaw	300

Rubber handle grips, space for extra blades and quick release wing adjuster. Takes all standard 300mm blades.



12265

**3D HACKSAW**

12270

Code	Description	Blade Length (mm)
12270	3D Hacksaw	300

Carbon blade. 90° +180° cutting angle. Suitable for workshops and tool boxes.



12270



# 12. Hacksaws, Cutters & Knives



17250-17252

## CUTTING TIN SNIPS

17250-17252

Code	Description	Length (mm)
17250	Straight & Right Hand Cutting Tin Snips Green Handles	250
17251	Straight & Left Hand Cutting Tin Snips Red Handle	250
17252	Straight Cutting Tin Snips Yellow Handle	250

Powerful aviation style tin snips for positive, easy and accurate cutting. A compound lever mechanism provides greater control with less effort. The serrated jaws prevent slippage and withstand heavy use. Designed with a locking-latch that holds the jaws closed when not in use. Tin snips are used to cut thin sheet metal of up to 1.2mm thickness and stainless steel of up to .7mm thickness. Made of CR-MO.



15100-1510

## BOLT CUTTERS

15100-15106

Code	Weight (grams)	Length (mm)	Cutting Force (Nm)	Cutting Dia Of Bolt (Hardness Less Than HRC 30)	Cutting Dia Of Bolt (Hardness Less Than HRC 20)
15100	750	300	145	4mm	5mm
15102	1600	450	345	6mm	8mm
15104	2700	600	490	8mm	10mm
15106	5500	900	835	12mm	16mm

Heavy duty bolt cutters.



15108

## BOLT CUTTERS

15108

Code	Weight (grams)	Length (mm)	Cutting Force (Nm)	Cutting Dia Of Bolt (Hardness Less Than HRC 30)	Cutting Dia Of Bolt (Hardness Less Than HRC 20)
15108	750	200	120	4mm	5mm



15100J-15106J

## BOLT CUTTERS JAWS

15100J-15106J

Code	Weight (grams)	Length (mm)	Cutting Force (Nm)	Cutting Dia Of Bolt (Hardness Less Than HRC 30)	Cutting Dia Of Bolt (Hardness Less Than HRC 20)
15100J	200	80	145	4mm	5mm
15102J	550	125	345	6mm	8mm
15104J	1500	145	490	8mm	10mm
15106J	1800	180	835	12mm	16mm

# 13. Measuring

## Be sure it all measures up.

Make sure it all measures up with KC Tools range of tapes, rulers, callipers, gauges and more. Get it right with KC Tools measuring equipment, each designed for precision and accuracy; our range includes tape measures as well as hardy steel rulers from 150mm to 1m lengths. No problem setting and scribing angles with the multi-function combination square.

The KC Tools digital callipers and micrometres will allow you to machine or describe your parts with ultimate accuracy.



# 13. Measuring



10395-10400

## TAPE MEASURES

10395-10400

Code	Description	Range	Weight (grams)	Length
10395	Dual Scale	0 - 5m	203	5m / 16Ft
10398	Cm Scale	0 - 8m	355	8m
10400	Dual Scale	0 - 10m	400	10m / 32Ft



10398CP

## TAPE MEASURE BOX SET

10398CP

Code	Description	RANGE (mm)
10398CP	12 x 10398	0 - 8M



M3200

## STEEL RULER

M3200

Code	Description	Size (mm)
M3200	1m Steel Ruler	1000 x 300 x 1.2



M3400

## STEEL SQUARE RULER

M3400

Code	Description	Size (mm)
M3400	Steel Square Ruler	400 x 600



50170-50171

## STEEL RULERS

50170-50171

Code	Size	Length
50170	0 - 150mm	150mm / 6"
50171	0 - 300mm	300mm / 12"



08319

## DOUBLE POINTED SCRIBER

08319

Code	Description	Weight (grams)	Length (mm)
08319	Double Pointed Scriber	48	216

Straight and 90° points. Removable heads for hard to reach places. Made from carbon steel with a hardness of 40° HRC.



M7150-M7200

## VERNIER CALIPERS

M7150- M7200

Code	Description	Range
M7150	Vernier Caliper With Clamping Screw	0 - 150mm
M7200	Vernier Caliper With Clamping Screw	0 - 200mm

Can measure internal and external depth and height. 0.05mm accuracy. Clamping screw on top of slider.



**DIGITAL CALIPERS - DUAL**

M1100-M1300

Code	Description	Range (mm)
M1100	Dual Scale Digital Caliper	0 - 100
M1150	Dual Scale Digital Caliper	0 - 150
M1200	Dual Scale Digital Caliper	0 - 200
M1300	Dual Scale Digital Caliper	0 - 300

0.02mm / 0.001" accuracy, zero setting at any position. Auto power off, fine adjust roller.



**MICROMETER SET 3PC**

M3075

Code	Description	Range (mm)
M3075	3 Piece Micrometer Set	0 - 25
		25 - 50
		50 - 75

Includes 0-25mm, 25-50mm, 50-75mm micrometers. 0.01mm graduation. Carbide measuring face. Setting gauge including ratchet stop.



M3075

**TELESCOPIC GAUGE SET**

M6400

Code	Description	Range	Weight (grams)
M6400	6 Piece Set	8 - 150mm	280

Quick and easy measuring of internal diameters cylinders, bearing houses, bores, bushes etc.



M6400

**DIAL INDICATOR**

M4025

Code	Description	Range
M4025	Dial Indicator	0 - 25mm

Dual scaled. 0.001mm dial reading. Dial and needle in out tolerance marker. Flat glass, back lug. Dial with fine thread/thick trapezoid patterns. Jewelled bearing construction. Shockproof can be used for checking surfaces when accurately grinding clearances and tolerances on engines where accuracy is required. Fits magnetic stand M8080.



M4025

# 13. Measuring



M8080

## MAGNETIC STAND

M8080

Code	Description	Range
M8080	Magnetic Stand	80kgs

Has "V" base that will grip onto flat or curved surfaces. Has a heavy duty switch. Fits dial indicator M4025.

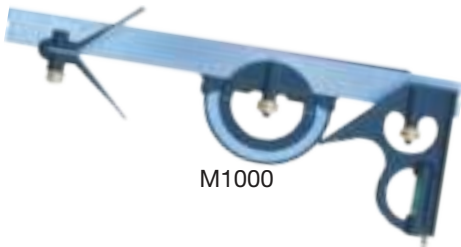

M1000

## COMBINATION SQUARE

M1000

Code	Description	Length (mm)
M1000	Combination Square	300

Combination square, stainless ruler, centre head. Multi angle. With bubble level.

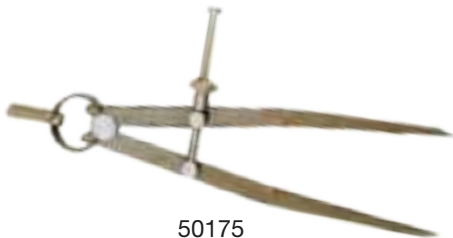

50175

## DIVIDER

50175

Code	Description	Range
50175	265mm	0 - 190mm

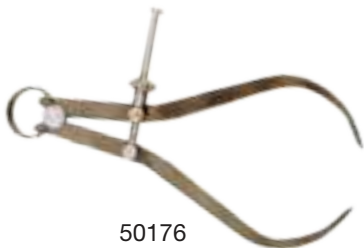

50176

## OUTSIDE CALIPER

50176

Code	Description	Range
50176	240mm	0 - 235mm



50178

## INSIDE CALIPER

50178

Code	Description	Range
50178	220mm	20 - 220mm

**FEELER GAUGE**

40030

Code	Description	Length (mm)
40030	26 Blade Feeler Gauge	89

0.0015" - 0.024", 0.04 - 0.60mm.



40030

**END FEELER GAUGE**

40032

Code	Description	Length (mm)
40032	32 Blade End Feeler Gauge	100

.001" - .040", .03mm - 1mm. Each blade has slim tapered ends and is made from quality steel that will last for many years.



40032

**FEELER GAUGE BRASS**

40034

Code	Description	Length (mm)
40034	6 Blade Brass Feeler Gauge	85

0.006" - 0.016", 0.152 - 0.406mm.



40034

**FEELER GAUGE OFFSET**

40038

Code	Description	Length (mm)
40038	12 Blade Offset Feeler Gauge	95

0.008" - 0.026", 0.203 - 0.660mm.



40038

**FEELER GAUGE**

40040

Code	Description	Length (mm)
40040	20 Blade Feeler Strips	200

0.05 - 1.00mm.



40040



# 14. Air Tools

**Power,  
impact and  
performance.**



The KC Tools air tool range is manufactured from high quality, tolerance matched components that are tool tested and performance checked to ensure reliability and a longer service life.

The range includes heavy duty impact wrenches, both composite and aluminium motor housings, with built in regulators for positive speed and torque control.

KC Air Tools feature light weight construction, low noise, low vibration and comfortable grip reducing operator fatigue, allowing for long hours of sustained use. These are the reasons why industry professionals prefer and recommend KC Air Tools for their workshops and construction sites.



# 14. Air Tools



SM401

## 3/8" DRIVE IMPACT WRENCH

SM401

Code	Description	Drive (square)	Speed (RPM)	Bolt Capacity	Decibel (dBA)		
SM401	Butterfly Wrench	3/8"	10,000	3/8"	110		
Torque (ft lbs)	Torque (Nm)	Air Inlet Thread (NPT)	Air Hose Size (ID)	CFM	LPM	Weight (kg)	Length (mm)
75	102	1/4"	3/8"	3	85	1	138

Built-in regulator for positive speed and torque control. Ring socket retainer allows for rapid socket changes. Comfortable to hold and operate. Butterfly control for easy direction changes. Safe to use underground.



SM41

## 3/8" DRIVE IMPACT WRENCH

SM41

Code	Description	Drive (square)	Speed (RPM)	Bolt Capacity	Decibel (dBA)		
SM41	Mini Wrench	3/8"	10,000	3/8"	83		
Torque (ft lbs)	Torque (Nm)	Air Inlet Thread (NPT)	Air Hose Size (ID)	CFM	LPM	Weight (kg)	Length (mm)
200	272	1/4"	3/8"	4	115	1.2	153

Built-in regulator for positive speed and torque control. Ring socket retainer allows for rapid socket changes. Features a composite motor housing, rear exhaust, one hand operation - forward / reverse and a Twin hammer clutch, light weight and low noise. Safe to use underground.



SM41-4017G

## 3/8" DRIVE IMPACT WRENCH

SM41-4017G

Code	Description	Drive (square)	Speed (RPM)	Bolt Capacity	Decibel (dBA)		
SM41-4017G	Impact Wrench	3/8"	11,000	1/2"	77		
Torque (ft lbs)	Torque (Nm)	Air Inlet Thread (NPT)	Air Hose Size (ID)	CFM	LPM	Weight (kg)	Length (mm)
400	542	1/4"	3/8"	5	142	1.6	156

Built-in comfort grip. Handle exhaust. Twin hammer clutch mechanism.



SM43

## 1/2" DRIVE MINI IMPACT WRENCH

SM43

Code	Description	Drive (square)	Speed (RPM)	Bolt Capacity	Decibel (dBA)		
SM43	Impact Wrench	1/2"	11,000	5/8"	83		
Torque (ft lbs)	Torque (Nm)	Air Inlet Thread (NPT)	Air Hose Size (ID)	CFM	LPM	Weight (kg)	Length (mm)
300	407	1/4"	3/8"	4	113	1.2	153

Light weight build with composite motor housing. Handle exhaust and low noise. Rotating air inlet. One hand operation for forward and reverse. Twin hammer. Safe to use underground. (VIC ONLY)



**1/2" DRIVE IMPACT WRENCH**

SM43 - 4134

Code	Description	Drive (square)	Speed (RPM)	Bolt Capacity			
SM43-4134	Impact Wrench	1/2"	8,000	5/8"			
Torque (ft lbs)	Torque (Nm)	Air Inlet Thread (NPT)	Air Hose Size (ID)	CFM	LPM	Weight (kg)	Length (mm)
820	1,112	1/4"	3/8"	4	113	2	187

Light weight build with composite motor housing. Handle exhaust and low noise. Rotating air inlet. One hand operation for forward and reverse. Twin hammer. Safe to use underground.



SM43 - 4134

**1/2" DRIVE IMPACT WRENCH**

SM43 - 4002

Code	Description	Drive (square)	Speed (RPM)	Bolt Capacity			
SM43-4002	Impact Wrench	1/2"	10,000	5/8"			
Torque (ft lbs)	Torque (Nm)	Air Inlet Thread (NPT)	Air Hose Size (ID)	CFM	LPM	Weight (kg)	Length (mm)
450	610	1/4"	3/8"	4	113	1.5	109

Light weight build with aluminium handle with steel clutch housing. Handle exhaust and low noise. Rotating air inlet. . Twin hammer. Safe to use underground.



SM43 - 4002

**1/2" DRIVE IMPACT WRENCH**

SM403

Code	Description	Drive (square)	Speed (RPM)	Bolt Capacity	Decibel (dBA)		
SM403	Impact Wrench	1/2"	7,000	5/8"	96		
Torque (ft lbs)	Torque (Nm)	Air Inlet Thread (NPT)	Air Hose Size (ID)	CFM	LPM	Weight (kg)	Length (mm)
250	338	1/4"	3/8"	4	115	2.38	156

Built-in regulator for positive speed and torque control. Single handed "thru-bolt action" reverse operation. Ring socket retainer allows for rapid socket changes. Front and rear bumper guards for added protection. Single hammer. Safe to use underground.



SM403

**1/2" DRIVE IMPACT WRENCH**

SM43-4037G

Code	Description	Drive (square)	Speed (RPM)	Bolt Capacity	Decibel (dBA)		
SM43-4037G	Impact Wrench	1/2"	8,000	3/4"	87		
Torque (ft lbs)	Torque (Nm)	Air Inlet Thread (NPT)	Air Hose Size (ID)	CFM	LPM	Weight (kg)	Length (mm)
900	1,220	1/4"	3/8"	6	170	2.7	170

Built-in comfort grip. Handle exhaust. Twin hammer clutch mechanism.



SM43-4037G

# 14. Air Tools



SM43-4037L

## 1/2" DRIVE IMPACT WRENCH

SM43-4037L

Code	Description	Drive (square)	Speed (RPM)	Bolt Capacity	Decibel (dBA)		
SM43-4037L	Impact Wrench	1/2"	8,000	3/4"	87		
Torque (ft lbs)	Torque (Nm)	Air Inlet Thread (NPT)	Air Hose Size (ID)	CFM	LPM	Weight (kg)	Length (mm)
900	1,220	1/4"	3/8"	6	170	2.7	170

Built-in comfort grip. Handle exhaust. Twin hammer clutch mechanism. With 2" Anvil for Tyre Service Industry



SM030

## 1/2" DRIVE IMPACT WRENCH

SM030

Code	Description	Ultimate Torque	Torque Range	Speed (RPM)	Decibel (dBA)	
SM030	Impact Wrench	600ft-lbs (813Nm)	50-460ft-lbs (68-542Nm)	7,000	88	
Air Pressure	CFM	LPM	Air Inlet Thread (NPT)	Air Hose Size (ID)	Weight (kg)	Length (mm)
90 PSI	4.4	125	1/4"	1/2"	2.2	204

Features an ergonomic handle design, composite motor housing, rotating air inlet and rear exhaust silencer. Twin hammer mechanism. Safe to use underground.



SM030L

## 1/2" DRIVE IMPACT WRENCH

SM030L

Code	Description	Ultimate Torque	Torque Range	Speed (RPM)	Decibel (dBA)	
SM030L	Impact Wrench	600ft-lbs (813Nm)	50-460ft-lbs (68-542Nm)	7,000	88	
Air Pressure	CFM	LPM	Air Inlet Thread (NPT)	Air Hose Size (ID)	Weight (kg)	Length (mm)
90 PSI	4.4	125	1/4"	1/2"	2.2	204

Features an ergonomic handle design, composite motor housing, rotating air inlet and rear exhaust silencer. Twin hammer mechanism. Safe to use underground.



SG0750

## 3/4" DRIVE IMPACT WRENCH

SG0750

Code	Description	Drive (square)	Speed (RPM)	Bolt Capacity	Decibel (dBA)		
SG0750	Impact Wrench	3/4"	4,800	1"	92		
Torque (ft lbs)	Torque (Nm)	Air Inlet Thread (NPT)	Air Hose Size (ID)	CFM	LPM	Weight (kg)	Length (mm)
800	949	1/4"	3/8"	7	199	4.8	238

Light weight build with composite motor housing. Handle exhaust and low noise. Rotating air inlet. One hand operation for forward and reverse. Twin hammer. Safe to use underground.

**3/4" DRIVE IMPACT WRENCH**

SG0750L

Code	Description	Drive (square)	Speed (RPM)	Bolt Capacity	Decibel (dBA)		
SG0750L	Impact Wrench	3/4"	4,800	1"	92		
Torque (ft lbs)	Torque (Nm)	Air Inlet Thread (NPT)	Air Hose Size (ID)	CFM	LPM	Weight (kg)	Length (mm)
800	1086	1/4"	3/8"	7	199	5.3	338

Built-in regulator for positive speed and torque control. Single handed "thru-bolt action" reverse operation. Ring socket retainer allows for rapid socket changes. Pin clutch. Safe to use underground. (NSW ONLY)



SG0750L

**3/4" DRIVE IMPACT WRENCH**

SM45-4057G

Code	Description	Drive (square)	Speed (RPM)	Bolt Capacity	Decibel (dBA)	
SM45-4057G	Impact Wrench	3/4"	5,500	1-1/8"	79	
Torque (ft lbs)	CFM	LPM	Air Inlet Thread (NPT)	Air Hose Size (ID)	Weight (kg)	Length (mm)
1,500	7	198	3/8"	1/2"	4.6	220

Built-in comfort grip. Handle exhaust. Twin hammer clutch mechanism.



SM45-4057G

**3/4" DRIVE IMPACT WRENCH**

SM454

Code	Description	Ultimate Torque	Torque Range	Speed (RPM)	Decibel (dBA)	
SM454	Impact Wrench	1,400ft-lbs (1,898Nm)	200-1,200ft-lbs (271-1,627Nm)	5,500	90	
Air Pressure	CFM	LPM	Air Inlet Thread (NPT)	Air Hose Size (ID)	Weight (kg)	Length (mm)
90 PSI	7	198	3/8"	1/2"	3.4	215

Features a composite motor housing, rotating air inlet and handle exhaust. Twin hammer mechanism. One hand forward and reverse operation. Safe to use underground.



SM454

**3/4" DRIVE IMPACT WRENCH**

SG0756

Code	Description	Drive (square)	Speed (RPM)	Bolt Capacity	Decibel (dBA)		
SG0756	Impact Wrench	3/4"	4,000	1-1/16"	90.8		
Torque (ft lbs)	Torque (Nm)	Air Inlet Thread (NPT)	Air Hose Size (ID)	CFM	LPM	Weight (kg)	Length (mm)
1,200	1,626	1/4"	3/8"	6	170	5.6	235

Twin hammer mechanism. High powered impact wrench suitable for most tasks. Single handed "thru-bolt action" reverse operation. Safe to use underground. (NSW ONLY)



SG0756



# 14. Air Tools



SM474

## 1" DRIVE IMPACT WRENCH

SM474

Code	Description	Ultimate Torque	Torque Range	Speed (RPM)	Decibel (dBA)	
SM474	Impact Wrench	1400ft-lbs (1,898Nm)	200-1,200ft-lbs (271-1,627Nm)	5,500	90	
Air Pressure	CFM	LPM	Air Inlet Thread (NPT)	Air Hose Size (ID)	Weight (kg)	Length (mm)
90 PSI	7	198	3/8"	1/2"	3.5	223

Features a composite motor housing, rotating air inlet and handle exhaust. Twin hammer mechanism. One hand forward and reverse operation. Safe to use underground.



SM47-4075

## 1" DRIVE IMPACT WRENCH

SM47-4075

Code	Description	Drive (square)	Speed (RPM)	Bolt Capacity	Decibel (dBA)	
SM47-4075	Impact Wrench	1"	5,000	1-3/4"	86	
Torque (ft lbs)	CFM	LPM	Air Inlet Thread (NPT)	Air Hose Size (ID)	Weight (kg)	Length (mm)
2,500	10	282	1/2"	1/2"	9.9	290

Heavy duty impact wrench. Twin hammer clutch mechanism. Adjustable side handle. 3 position power setting in forward and reverse. Handle exhaust.



SM47-4071

## 1" DRIVE HEAVY DUTY IMPACT WRENCH

SM47-4071

Code	Description	Drive (square)	Speed (RPM)	Bolt Capacity	Decibel (dBA)	
SM47-4071	Heavy Duty Impact Wrench	1"	5,000	1-3/4"	86	
Torque (ft lbs)	CFM	LPM	Air Inlet Thread (NPT)	Air Hose Size (ID)	Weight (kg)	Length (mm)
2,200	10	282	1/2"	1/2"	11.9	346

Side support handle for better control when operate. Handle with inside trigger. Steel ring to retain the sockets. Twin hammer clutch / Pinless clutch mechanism.



SM47-4071L

## 1" DRIVE HEAVY DUTY IMPACT WRENCH

SM47-4071L

Code	Description	Drive (square)	Speed (RPM)	Bolt Capacity	Decibel (dBA)	
SM47-4071L	Heavy Duty Impact Wrench	1"	5,000	1-3/4"	86	
Torque (ft lbs)	CFM	LPM	Air Inlet Thread (NPT)	Air Hose Size (ID)	Weight (kg)	Length (mm)
2,200	10	282	1/2"	1/2"	11.9	497

Side support handle for better control when operate. Handle with inside trigger. Steel ring to retain the sockets. Twin hammer clutch / Pinless clutch mechanism.

**1/4" DRIVE MINI RATCHET WRENCH**

SG0719

Code	Description	Drive (square)	Speed (RPM)	Bolt Capacity	Decibel (dBA)
SG0719	Ratchet Wrench	1/4"	240	1/4"	90

Torque (ft lbs)	Torque (Nm)	Air Inlet Thread (NPT)	Air Hose Size (ID)	CFM	LPM	Weight (kg)	Length (mm)
18	24	1/4"	1/4"	3	85	0.5	158

Compact head design allows flexibility in tight areas. Comfortable grip for stability. Variable speed trigger for added control. Applications: general assembly, maintenance, fastening.



SG0719

**3/8" DRIVE MINI RATCHET WRENCH**

SG0720

Code	Description	Drive (square)	Speed (RPM)	Bolt Capacity	Decibel (dBA)
SG0720	Ratchet Wrench	3/8"	240	3/8"	90

Torque (ft lbs)	Torque (Nm)	Air Inlet Thread (NPT)	Air Hose Size (ID)	CFM	LPM	Weight (kg)	Length (mm)
18	24	1/4"	1/4"	3	85	0.55	158

Compact head design allows flexibility in tight areas. Comfortable grip for stability. Variable speed trigger for added control. Applications: general assembly, maintenance, fastening.



SG0720

**3/8" DRIVE RATCHET WRENCH**

SM30

Code	Description	Drive (square)	Speed (RPM)	Bolt Capacity	Decibel (dBA)
SM30	Ratchet Wrench	3/8"	150	3/8"	88

Torque (ft lbs)	Torque (Nm)	Air Inlet Thread (NPT)	Air Hose Size (ID)	CFM	LPM	Weight (kg)	Length (mm)
50	66	1/4"	3/8"	4	115	1.1	250

Compact head design allows flexibility in tight areas. Comfortable grip for stability. Variable speed trigger for added control. Applications: general assembly, maintenance, fastening.



SM30

**1/2" DRIVE RATCHET WRENCH**

SM31

Code	Description	Drive (square)	Speed (RPM)	Bolt Capacity	Decibel (dBA)
SM31	Ratchet Wrench	1/2"	150	1/2"	94

Torque (ft lbs/Nm)	Air Inlet Thread (NPT)	Air Hose Size (ID)	CFM	LPM	Weight (kg)	Length (mm)
50 / 68	1/4"	3/8"	4	115	1.1	250

Compact head design allows flexibility in tight areas. Comfortable grip for stability. Variable speed trigger for added control. Applications: general assembly, maintenance, fastening.



SM31

# 14. Air Tools



SG0735

## 1/2" DRIVE HEAVY DUTY RATCHET WRENCH SG0735

Code	Description	Drive (square)	Speed (RPM)	Bolt Capacity	Decibel (dBA)	
SG0735	Ratchet Wrench	1/2"	150	1/2"	103	
Torque (ft lbs/Nm)	Air Inlet Thread (NPT)	Air Hose Size (ID)	CFM	LPM	Weight (kg)	Length (mm)
90 / 122	1/4"	3/8"	5	142	2	360

Delivers high power in confined spaces. Compact head design allows flexibility in tight areas. Comfortable grip for stability. Variable speed trigger for added control. Applications: general assembly, maintenance, fastening. Heavy duty.



SM512

## 1/4" DIE GRINDER SM512

SM512

Code	Description	Speed (RPM)	Collet Size	Decibel (dBA)		
SM512	Die Grinder	22,000	1/4" (6mm)	93		
Air Pressure	Air Inlet Thread (NPT)	Air Hose Size (ID)	CFM	LPM	Weight (kg)	Length (mm)
90 PSI	1/4"	3/8"	4	115	0.5	169

Heavy duty, light weight construction for general high speed polishing and grinding. Ball bearing construction for longer tool life. Planetary gearing for heavy duty use. Grooved handle design for firm grip, variable speed throttle for positive speed control. Cylinder construction of high quality steel. Built-in adjustable air regulator. Tool has rear exhaust to direct air away from work surface.





### 1/4" DIE GRINDER

SM522

Code	Description	Speed (RPM)	Collet Size	Decibel (dBA)	
SM522	Die Grinder	22,000	1/4" (6mm)	85	
Air Pressure	Air Inlet Thread (NPT)	Air Hose Size (ID)	CFM LPM	Weight (kg)	Length (mm)
90 PSI	1/4"	3/8"	4 115	0.5	158

Heavy duty, light weight construction for general high speed polishing and grinding. Ball bearing construction for longer tool life. Planetary gearing for heavy duty use. Grooved handle design for firm grip, variable speed throttle for positive speed control. Cylinder construction of high quality steel. Built-in adjustable air regulator. Tool has rear exhaust to direct air away from work surface.



SM522

### 1/4" DIE GRINDER

SM512E

Code	Description	Speed (RPM)	Collet Size	Decibel (dBA)	
SM512E	Die Grinder	22,000	1/4" (6mm)	93	
Air Pressure	Air Inlet Thread (NPT)	Air Hose Size (ID)	CFM LPM	Weight (kg)	Length (mm)
90 PSI	1/4"	3/8"	4 115	1.2	300

Heavy duty, light weight construction for general high speed polishing and grinding. Ball bearing construction for longer tool life. Planetary gearing for heavy duty use. Grooved handle design for firm grip, variable speed throttle for positive speed control. Cylinder construction of high quality steel. Built-in adjustable air regulator. Tool has rear exhaust to direct air away from work surface. Extended anvil.



SM512E

### 1/4" ANGLE DIE GRINDER

SM055

Code	Description	Speed (RPM)	Collet Size	Decibel (dBA)	
SM055	90° Angled	20,000	1/4" (6mm)	90	
Air Pressure	Air Inlet Thread (NPT)	Air Hose Size (ID)	CFM LPM	Weight (kg)	Length (mm)
90 PSI	1/4"	3/8"	4 115	0.6	158

Features rubber grip, safety throttle lever, rotating air inlet, handle exhaust and a new housing design. Applications: grinding metal surfaces, sharpening, weld preparation.



SM055

### DIE GRINDER KIT 7PC

SM513

Code	Description	Speed (RPM)	Weight (kg)	Decibel (dBA)
SM513	Die Grinder Kit	22,000	1.1	93

1 Die Grinder 1/4" Drive, 2 Collets 1/4" & 1/8", 10 Mounted Points in a Blow Moulded Case. Contains SM512 Die Grinder.



SM513

# 14. Air Tools



SG0519

## ANGLE GRINDER

SG0519

Code	Description	Pad Size (inch)	Speed (RPM)	Decibel (dBA)	Air Pressure
SG0519	Angle Grinder	2	11,000	89	90 PSI
CFM	LPM	Air Inlet Thread (NPT)	Air Hose Size (ID)	Weight (kg)	Length (mm)
6	170	1/4"	3/8"	1.9	225

Two position (Right hand/Left hand) support allows access to tight spaces. Metal wheel guard allows safe operation. Applications: grinding metal surfaces, sharpening, weld preparation.



SM065

## ANGLE GRINDER

SM065

Code	Description	Disk Size (inch)	Spindle Size	Speed (RPM)	Decibel (dBA)	
SM065	Angle Grinder	4	M10x1.5mm	10,000	83	
Air Pressure	Air Inlet Thread (NPT)	Air Hose Size (ID)	CFM	LPM	Weight (kg)	Length (mm)
90 PSI	1/4"	3/8"	4	115	2	138

Features composite handle, spindle lock, rear exhaust, low noise and side handle. Protective guard is adjustable to 9 positions. Accepts 0.8mm - 6mm wheel. Applications: grinding metal surfaces, sharpening, weld preparation.



SM070

## ANGLE GRINDER

SM070

Code	Description	Disk Size (inch)	Spindle Size	Speed (RPM)	Decibel (dBA)	
SM070	Angle Grinder	5	M14x2.0mm	10,000	83	
Air Pressure	Air Inlet Thread (NPT)	Air Hose Size (ID)	CFM	LPM	Weight (kg)	Length (mm)
90 PSI	1/4"	3/8"	4	115	2	238

Features composite handle, spindle lock, rear exhaust, low noise and side handle. Protective guard is adjustable to 9 positions. Accepts 0.8mm - 6mm wheel. Applications: grinding metal surfaces, sharpening, weld preparation.



SG0420

## DUAL ACTION SANDER

SG0420

Code	Description	Pad Size (mm)	Spindle Size	Speed (RPM)	Decibel (dBA)	
SG0420	Dual Action	150	5/16" - 24	10,000	93.3	
Air Pressure	Air Inlet Thread (NPT)	Air Hose Size (ID)	CFM	LPM	Weight (kg)	Length (mm)
90 PSI	1/4"	3/8"	4	115	1.7	206
Code	TW200047					
Description	Sanding Pad					

Heavy duty balanced ball bearing construction for vibration free performance. Built-in regulator for positive speed control. Positive grip handle and rubberhousing for non-slip sanding. Balanced counterweight design provides orbital or rotary action. Applications: sanding, featheredging, scuffing, finishing and blending. Materials: metals, aluminium, ceramics, composites, stainless steel, woodworking, plastics, fiberglass, rubber, glass, stone and automotive body filler.

**STRAIGHT LINE SANDER**

SG0430

Code	Description	Pad Size (mm)	Speed (RPM)	Decibel (dBA)		
SG0430	Straight Line	63 x 394	2,500	87		
Air Pressure	Air Inlet Thread (NPT)	Air Hose Size (ID)	CFM	LPM	Weight (kg)	Length (mm)
90 PSI	1/4"	3/8"	8	127	2.8	400

Dual piston design gives extra power to prevent stalling and tackles sanding jobs like smoothing body filler and levelling large flat areas.



SG0430

**PALM SANDER**

SM095

Code	Pad Size	Spindle Thread	Speed (RPM)	Decibel (dBA)	Oscillating Movement (mm)		
SM095	6"	5/16"-24	11,000	76	5		
Orbit Diameter	Air Pressure	Air Inlet Thread (NPT)	Air Hose Size (ID)	CFM	LPM	Weight (kg)	Length (mm)
3/16"	90 PSI	1/4"	3/8"	3	85	0.8	163

Features composite motor housing, low noise, low vibrations and is well balanced. Applications: sanding, scuffing, finishing, blending and woodworking.



SM095

**PALM SANDER**

SM100

Code	Pad Size	Spindle Thread	Speed (RPM)	Decibel (dBA)	Oscillating Movement (mm)		
SM100	6"	5/16"-24	11,000	84	5		
Orbit Diameter	Air Pressure	Air Inlet Thread (NPT)	Air Hose Size (ID)	CFM	LPM	Weight (kg)	Length (mm)
3/16"	90 PSI	1/4"	3/8"	3	85	0.8	213

Features composite motor housing, low noise, low vibrations and is well balanced. Dust free. Applications: sanding, scuffing, finishing, blending and woodworking.



SM100

**MINI ORBITAL SANDER KIT 64PC**

SM085

Code	Description	Pad Size	Speed (RPM)	Decibel (dBA)		
SM085	64 Piece Mini Sander Kit	2" or 3"	15,000	81		
Air Pressure	Air Inlet Thread (NPT)	Air Hose Size (ID)	CFM	LPM	Weight (kg)	Length (mm)
90 PSI	1/4"	3/8"	4	115	1.5	120

Includes: 1 x Mini orbital sander with rubber grip, 1 x Key wrench, 1 x 2" Velcro sanding pad, 1 x 3" Velcro sanding pad, 10 x 320 Grit sanding paper 2", 10 x 400 Grit sanding paper 2", 10 x 600 Grit sanding paper 2", 10 x 320 Grit sanding paper 3", 10 x 400 Grit sanding paper 3" and 10 x 600 Grit sanding paper 3".



SM085



# 14. Air Tools

## MINI DISC SANDER KIT 70PC

SM015

Code	Description	Pad Size (inch)	Speed (RPM)	Decibel (dBA)
SM015	70 Piece Mini Sander Kit	2 or 3	15,000	81

Air Pressure	Air Inlet Thread (NPT)	Air Hose Size (ID)	CFM	LPM	Weight (kg)	Length (mm)
90 PSI	1/4"	3/8"	4	115	1.5	120

Includes: 1 x Mini disc sander with rubber grip, 1 x Spanner wrench, 1 x 2" Backup sanding pad, 10 x 60 Grit sanding discs 2", 10 x 80 Grit sanding discs 2", 10 x 120 Grit sanding discs 2", 3 x 2" Surface prep pads (fine, medium & course), 1 x 3" Backup sanding pad, 10 x 60 Grit sanding discs 3", 10 x 80 Grit sanding discs 3", 10 x 120 Grit sanding discs 3" and 3 x 3" Surface prep pads (fine, medium & course).



SM015

## MINI POLISHER KIT 6PC

SM090

Code	Description	Pad Size (inch)	Speed (RPM)	Decibel (dBA)
SM090	6 Piece Mini Polisher Kit	3	25,000	81

Air Pressure	Air Inlet Thread (NPT)	Air Hose Size (ID)	CFM	LPM	Weight (kg)	Length (mm)
90 PSI	1/4"	3/8"	4	115	1.8	130

Includes: 1 x Mini polisher with rubber grip, 1 x Key wrench, 1 x 3" Velcro sanding pad, 1 x 3-1/2" Bonnet, 1 x 3-1/2" Yellow compounding pad & 1 x 3-1/2" White compounding pad.



SM090



### 3/8" REVERSIBLE DRILL

SM705

Code	Description	Chuck Size (inch)	Speed (RPM)	Spindle Thread	Decibel (dBA)	
SM705	Reversible Drill	3/8	1,800	3/8" - 24	85	
Air Pressure	Air Inlet Thread (NPT)	Air Hose Size (ID)	CFM	LPM	Weight (kg)	Length (mm)
90 PSI	1/4"	3/8"	4	115	1.4	163

One touch forward/reverse switch. Ball bearing construction. Planetary gearing for heavy duty use. Handle exhaust reduces noise. Variable speed trigger for precise control. Keyed chuck. Applications: drilling, fastening in concrete, metal and wood. Safe to use underground.



SM705

### 3/8" REVERSIBLE DRILL

SM709R

Code	Description	Chuck Size (inch)	Speed (RPM)	Spindle Thread	Decibel (dBA)	
SM709R	90° Angle Drill	3/8	1,500	3/8" - 24	90	
Air Pressure	Air Inlet Thread (NPT)	Air Hose Size (ID)	CFM	LPM	Weight (kg)	Length (mm)
90 PSI	1/4"	3/8"	4	115	1.8	175

Ball bearing construction. Planetary gearing for heavy duty use. Handle exhaust reduces noise. Angle design works in tight spaces. Lever trigger for easy start-stop. Variable speed trigger. Keyed chuck. Applications: drilling, fastening in concrete, metal and wood. Safe to use underground.



SM709R

### 1/2" REVERSIBLE DRILL

SM704

Code	Description	Chuck Size (inch)	Speed (RPM)	Spindle Thread	Decibel (dBA)	
SM704	Reversible Drill	1/2	800	3/8" - 24	89	
Air Pressure	Air Inlet Thread (NPT)	Air Hose Size (ID)	CFM	LPM	Weight (kg)	Length (mm)
90 PSI	1/4"	3/8"	4	115	1.8	175

One touch forward/reverse switch. Ball bearing construction. Planetary gearing for heavy duty use. Handle exhaust reduces noise. Variable speed trigger for precise control. Keyed chuck. Applications: drilling, fastening in concrete, metal and wood. Safe to use underground.



SM704

### SHORT ROUND SHANK HAMMER

SG0101R

Code	Description	Speed (RPM)	Air Pressure		
SG0101R	Short Round Shank Hammer	5,000	90PSI		
Air Inlet Thread (NPT)	Air Hose Size (ID)	CFM	LPM	Length (mm)	Decibel (dBA)
1/4"	3/8"	4	115	131	92

Uses pressurised air to drive a hammer into a work-piece for shaping, scoring or smoothing.



SG0101R

### MEDIUM AIR HAMMER KIT

SG0204PSR

Code	Description	Speed (RPM)	Weight (kg)
SG0204PSR	Medium Air Hammer Kit	3,200	3.3

Uses pressurised air to drive a hammer into a work-piece for shaping, scoring or smoothing. Includes: 1 Air Hammer, 5 Chisels 125mm & 1 Oiler.



SG0204PSR

# 14. Air Tools



SG0810

## AIR RIVETER

SG0810

Code	Description	Stroke Length	Air Hose Size (ID)	Blind Rivet Setting Capacity
SG0810	Air Riveter	9/16"	3/8"	3/16"
Air Pressure	Weight (kg)	Length (mm)	Decibel (dBA)	Maximum Pulling Power (Lbs)
90 PSI	2	156	76	1,940

Easy one hand operation in any position. High speed performance ideal for automotive and construction assembly work. Heavy duty. Suitable for aluminium rivets.



SG0814

## AIR RIVETER

SG0814

Code	Description	Stroke Length	Air Hose Size (ID)	Blind Rivet Setting Capacity
SG0814	Air Riveter	10/16"	3/8"	1/4"
Air Pressure	Weight (kg)	Length (mm)	Decibel (dBA)	Maximum Pulling Power (Lbs)
90 PSI	2.1	325	78	3,055

Easy one hand operation in any position. High speed performance ideal for automotive and construction assembly work. Heavy duty. Suitable for aluminium rivets.



SM135

## UTILITY IN-LINE DRIVER KIT 12PC

SM135

Code	Description	Speed (RPM)	Decibel (dBA)			
SM135	12 Piece Utility In-Line Driver Kit	3,500	86			
Air Pressure	Air Inlet Thread (NPT)	Air Hose Size (ID)	CFM	LPM	Weight (kg)	Length (mm)
90 PSI	1/4"	3/8"	4	115	4.12	305

Used extensively in the panel beating industry.

Includes: 1 x Utility in-line driver, 1 x Adaptor for rubber eraser or brush, 1 x Adaptor for double black wheels, 1 x Adaptor for single black wheel, 1 x Water based paint rubber eraser, 1 x Rubber eraser & 6 x Black strip wheels.



SM135



-  Ref 1. Adaptor for Rubber Eraser or Brush SM135RH
-  Ref 2. Water Based Paint Rubber Eraser SM135RWW
-  Ref 3. Rubber Eraser SM135RW
-  Ref 4. 6 Pieces Black Strip Wheels SM135BW
-  Ref 5. Adaptor for Double Black Wheels SM135BHD
-  Ref 6. Adaptor for Single Black Wheel SM135BHS
-  Ref 7/9. 11 / 23mm Coarse Wire Brushes SM135WW711 / SM135WW723
-  Ref 8/10. 11 / 23mm Fine Wire Brushes SM135WW511 / SM135WW523

## ACCESSORIES FOR SM135

SM135RH-SM135WW511

Code	Description	Ref
SM135RH	Adaptor for Rubber Eraser or Brush	1
SM135RWW	Water Based Paint Rubber Eraser	2
SM135RW	Rubber Eraser	3
SM135BW	6 Pieces Black Strip Wheels	4
SM135BHD	Adaptor for Double Black Wheels	5
SM135BHS	Adaptor for Single Black Wheel	6
SM135WW723	23mm Coarse Wire Brushes	7
SM135WW523	23mm Fine Wire Brushes	8
SM135WW711	11mm Coarse Wire Brushes	9
SM135WW511	11mm Fine Wire Brushes	10



**METAL SHEARS**

SM204

Code	Description	Cutting Capacity	Speed (RPM)	Decibel (dBA)	Air Pressure
SM204	Air Metal Shears	18 Gauge	2,600	82	90 PSI
Air Inlet Thread (NPT)	Air Hose Size (ID)	CFM	LPM	Weight (kg)	Length (mm)
1/4"	3/8"	4	115	2.3	206

Heavy-duty shear head provides long life and reliable cutting. Ergonomic grip for comfort and stability. Applications: shears aluminium, plastic, tin and steel up to 18 gauge.



SM204

**CUT-OFF TOOL**

SG0516

Code	Description	Cutting Capacity	Speed (RPM)	Decibel (dBA)	Air Pressure
SG0516	Cut-off Tool	25mm	20,000	98	90 PSI
Air Inlet Thread (NPT)	Air Hose Size (ID)	CFM	LPM	Weight (kg)	Length (mm)
1/4"	3/8"	4	115	0.9	200

Use for cutting through sheet metal, fibreglass, bolts, muffler clamps and hangers.



SG0516

**AIR NIBBLER**

SM213

Code	Description	Cutting Capacity	Speed (RPM)	Decibel (dBA)	Air Pressure	
SM213	Air Nibbler	1.2mm	2,600	91	90 PSI	
Air Inlet Thread (NPT)	Air Hose Size (ID)	Cutting Speed (mpm)	CFM	LPM	Weight (kg)	Length (mm)
1/4"	3/8"	2.6	4	115	0.9	175

"Pull" type. Cuts on the upward stroke to increase die life.



SM213

**AIR PUNCH & FLANGE TOOL**

SG0692

Code	Description	Punch (mm)	Decibel (dBA)	Air Pressure		
SG0692	Air Punch & Flange	5.0	70	90 PSI		
Capacity (mm)	Steel (mm)	Air Hose Size (ID)	CFM	LPM	Weight (kg)	Length (mm)
0.8 - 1.4		3/8"	4	115	1.9	255

Ideal for auto body work. Punch holes for riveting and welding or for creating flanges for joining sheet metal.



SG0692

# 14. Air Tools



SG9907

## AIR CAULKING GUN

SG9907

Code	Description	Bore Size (mm)	Tube Length (mm)	CFM	LPM
SG9907	Air Caulking Gun	50	215	12	340
Air Pressure	Air Inlet Thread (NPT)	Air Hose Size (ID)	Weight (kg)	Decibel (dBA)	
30-60 PSI	1/4"	3/8"	1.1	82	

Suitable for the automotive workshop. Accepts standard size 215 x 50mm cartridges.



SG0822

## AIR BODY SAW

SG0822

Code	Description	Cutting Capacity	Speed (RPM)	Decibel (dBA)	Air Pressure
SG0822	Air Body Saw	16 Gauge	9,000	87	90 PSI
Air Inlet Thread (NPT)	Air Hose Size (ID)	CFM	LPM	Weight (kg)	Length (mm)
1/4"	3/8"	4	115	0.5	231

Code	SG0822A	SG0822B
Description	24TPI Blade	32TPI Blade

The convenient paddle switch with lock off prevents accidental start up. The rubberised cushion grip allowing for maximum comfort. Blades available: 24 teeth and 32 teeth metal blade. This unit is perfect for metal or wood cutting.



SG0315

## FLUX CHIPPER

SG0315

Code	Description	Speed (RPM)	Decibel (dBA)	Air Pressure	
SG0315	Flux Chipper	4,000	90.3	90 PSI	
Air Inlet Thread (NPT)	Air Hose Size (ID)	CFM	LPM	Weight (kg)	Length (mm)
1/4"	3/8"	4	115	1.5	400

Tool for weld flux removal and light chipping.



SG0315NS

## NEEDLE SCALER

SG0315NS

Code	Description	Needles	Speed (RPM)	Decibel (dBA)	Air Pressure
SG0315NS	Needle Scaler	19	4,000	90.3	90 PSI
Air Inlet Thread (NPT)	Air Hose Size (ID)	CFM	LPM	Weight (kg)	Length (mm)
1/4"	3/8"	4	115	2.6	410

Pneumatic needle scalers provide a thorough and effective method of removing coatings, corrosion and other materials. Scaler will work on almost any surface.



SG2110NS

## NEEDLE SCALER

SG2110NS

Code	Description	Needles	Speed (RPM)	Decibel (dBA)	Air Pressure
SG2110NS	Needle Scaler	19	3,000	97	90 PSI
Air Inlet Thread (NPT)	Air Hose Size (ID)	CFM	LPM	Weight (kg)	Length (mm)
1/4"	3/8"	4	115	2.5	370

Pneumatic needle scalers provide a thorough and effective method of removing coatings, corrosion and other materials. Scaler will work on almost any surface.

### AIR GREASE GUN KIT

SG843K

Code	Description	Air Inlet Thread (NPT)	Air Hose Size (ID)	Weight (kg)
SG843K	Air Grease Gun Kit	1/4"	1/4"	2.28

Air is directed into the gun by a hose and the air pressure forces the grease through the tip (nozzle). Usually a thicker or heavier grease is used. Includes hand type lever grease gun and flex nozzle. Accepts standard size 215 x 50mm cartridges.



SG843K

### ENGINE CLEANING GUN

SG1057

Code	Description	Cup Capacity	Fluid tip Size (ID)	Air Pressure
SG1057	Engine Cleaning Gun	0.7L	1.8mm	50 - 70 PSI

Air inlet thread (NPT)	Fluid Inlet	CFM	LPM	Weight (kg)	Height (mm)
1/4"	3/8"	4	115	0.7	216

Polished base. Use this heavy duty engine cleaning gun for fast and easy cleaning of motors, engines, motorbikes, farm equipment and other items. Can be used with a variety of solvents or cleaners. Cleaning agents not included.



SG1057

### AIR DUSTERS

SG1072-SG1072XL

Code	Description	Air Inlet Thread (NPT)	Weight (kg)	Length (mm)
SG1072	Air Duster	1/4"	.2	100
SG1072L	Long Nose	1/4"	.26	325
SG1072XL	Extra Long Nose	1/4"	.3	500

Lever action air duster makes cleaning and dusting easy. A fast way to air clean tools, parts, equipment and machinery using high pressure air.



SG1072-SG1072XL

### ABRASIVE BLASTER KIT

SG1068

Code	Description	Air Hose Size (ID)	Air Inlet Thread (NPT)	CFM	LPM	Weight (kg)
SG1068	Blaster Kit	1/4"	1/4"	3.6	102	1.25

Complete set designed for fast efficient sand blasting of parts and surfaces. Sandblast medium not included.



SG1068

### TWO WAY GUN

SG1222-SG1222N

Code	Description	Air Pressure	Air Inlet Thread (NPT)	CFM	LPM	Weight (kg)
SG1222	Two Way Gun	90 PSI	1/4"	3.6	102	0.35
SG1222N	Gun Only	90 PSI	1/4"	3.6	102	0.25

Vacuum/suction, cleaning/blowing dust from work benches, parts and all types of machinery and tools. Vacuum anywhere around the workshop, shed, farm, boat, etc.



SG1222-SG1222N



# 14. Air Tools



SA0101S

## SPRING RETAINER

SA0101S

Code	Description
SA0101S	Standard Spring Retainer



SB2021-1-SB2041-1

## AIR FILTER REGULATORS

SB2021-1-SB2041-1

Code	NPT	Operating Air pressure	Max. Operating Air pressure
SB2021-1	1/4"	5-6 Kg-cm <sup>2</sup> / 70-85 PSI	10 Kg-cm <sup>2</sup> / 142 PSI
SB2031-1	3/8"	5-6 Kg-cm <sup>2</sup> / 70-85 PSI	10 Kg-cm <sup>2</sup> / 142 PSI
SB2041-1	1/2"	5-6 Kg-cm <sup>2</sup> / 70-85 PSI	10 Kg-cm <sup>2</sup> / 142 PSI

Can filter particles up to 40 um.



SM911

## DOUBLE SUCTION CUP

SM911

Code	Description	Weight (kg)	Lifting Capacity
SM911	Double Action Suction Cup	1.0	108kg / 240lbs

Plastic cups. Double suction pads for secure grip can be used on glass, plastic, steel, aluminium.



G301

## MINI OILER

G301

Code	Description	Air Inlet	Air Outlet
G301	Mini Brass Oiler	1/4"	1/4"



SA12-SA38

## SWIVEL JOINT

SA12-SA38

Code	Description	Joint Size
SA12	Swivel Joint	1/2" x 1/2"
SA14	Swivel Joint	1/4" x 1/4"
SA38	Swivel Joint	3/8" x 3/8"



SA225-SA350

## AIR RECOIL HOSE

SA225-SA350

Code	Description	Thread Size (inch)	Length (m)
SA225	Air Recoil Hose	1/4	7.6
SA250	Air Recoil Hose	1/4	15.2
SA325	Air Recoil Hose	3/8	7.6
SA350	Air Recoil Hose	3/8	15.2

Made of PVC. Swivel head.

**PVC AIR HOSE WITH COUPLINGS**

AHC15-AHC30

Code	Description	Coupling Size (inch)	Length (m)
AHC15	Air Hose	3/8	15
AHC30	Air Hose	3/8	30



AHC15-AHC30

## OPERATION & MAINTENANCE

**AIR REGULATORS:**

Clean, dry and lubricated air at the correct pressure is the most important requirement for perfect operation of air tools. KC Tools range of air tools are designed to operate at 90 P.S.I. unless otherwise specified.

**MOISTURE SEPARATORS:**

On installations where the piping system does not provide clean, dry air the use of filters at hose connections points is recommended.

**STRAINERS/FILTERS:**

Many tools are provided with air strainers or filters. To eliminate air restriction these strainers must be kept clean and free of obstructions. Strainers or filters should be used at each hose outlet.

**LUBRICATION:**

Many pneumatic tools, due to weight and space limitations do not contain built-in lubricators. Air line lubricators are recommended with all air tools.

**MOISTURE ELIMINATION:**

The amount of moisture carried by compressed air varies with the temperature. As the temperature drops after compression, water is precipitated. To eliminate as much water as possible, compressors should be equipped with intercoolers, after coolers and full size receivers. These should be kept drained and in good working condition.

**COMPRESSOR AIR INTAKE:**

Locate the air intake to obtain the coolest, driest and cleanest air possible. Intakes should be of ample size and as direct as possible. Avoid dusty or wet locations.

**PIPING SYSTEM:**

Air mains and lines should be large enough to avoid excessive pressure loss under heavy working conditions. Pipe lines should be provided with drains for trapping water before it reaches the hose outlet. The 'pitch' of the mains line should be in the direction of the air flow so that gravity and air flow will carry the water to traps located at regular intervals. Provision for quick and positive inspection of operation for leakage should be made when traps are installed. Taps in the drains are usually provided for draining and inspection of water collected. To prevent moisture from reaching the tools, down pipes or hose connections should never be taken directly from the bottom of air pipes or mains. Connections should be made at the top of the a main line. Valves and hose connections should be large enough to pass the maximum amount of air required by the tool or tools on the line.

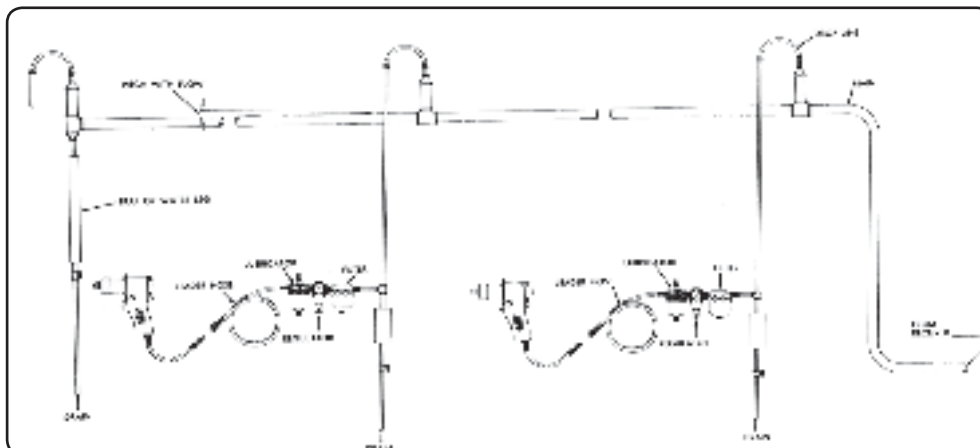

# 15. Automotive & Speciality

**Get those  
wheels  
rolling.**





Set up shop with the full range of KC Tools quality speciality and automotive tools, designed to get you down and dirty with your car. We've got the tools for general maintenance, minor repairs and weekender nip and tucks so you can be fully equipped to take on any ding that gets thrown your way. If you're a bit of an expert on your car we can equip you with bearing separators, oil filter removers and tyre gauges to get your car in tip-top shape.

Our range of automotive and specialty tools will keep you well equipped to deal with all your automotive mishaps.



# 15. Automotive & Speciality



08412

## SWITCH REMOVER

08412

Code	Description	Drive (inch)	Spanner Size (inch)
08412	Switch Remover	3/8"	1-1/16

Handy socket for removing and installing most oil pressure and stop light switches.



10455

## BATTERY HYDROMETER

10455

Code	Description	Length (mm)	Weight (grams)
10455	Battery Hydrometer	308	140

Hydrometers are used to test the charge state of lead-acid batteries. Simply draw battery acid up into the hydrometer by squeezing and releasing the rubber bulb. The hydrometer has an easy to read scale which indicates the state of charge of the cell being tested. Squeeze the bulb again to empty the acid back into the cell. Then flush the hydrometer with clean water.



10457

## BATTERY TERMINAL CLEANER

10457

Code	Description	Weight (grams)
10457	Battery Terminal Cleaner	158

This battery terminal cleaner features two accurately shaped tools to scrape at the correct taper, both positive and negative battery posts. It also has a tapered reamer to ream out at the correct taper of the battery terminals so as to ensure maximum contact between battery terminals and battery posts.



10458

## BATTERY CLEANER - BRUSH

10458

Code	Description	Weight (grams)
10458	Metal Battery Brush	69

Similar usage as part 10457 but for less corroded posts and terminals. Features both internal and external wire brushes set at the correct taper for cleaning battery posts and terminals.



10425

## CIRCUIT TESTER - COMPUTER SAFE

10425

Code	Length (mm)	Width (mm)	Weight (grams)	System	Lead Length (m)
10425	200	24	200	3 to 15v	1.22

Used to safely check standard primary automotive circuitry and on-board computer controlled electrical systems whilst preventing damage to the microprocessor.

**CIRCUIT TESTER**

10426

Code	Description	System	Lead Length (m)
10426	Circuit Tester	6 and 12v	1.22

This circuit tester is handy for checking for continuity in 6 volt and 12 volt circuitry.



10426

**NEEDLE PROBE CIRCUIT TESTER**

10427

Code	Length (mm)	Width (mm)	Weight (grams)	Volts (v)	Lead Length (mm)
10427	108	9	70	12	900

Solid brass body with a very sharp stainless steel probe. 100mm long including the brass screw-on protective cover. Earth crocodile clamp at end of cable.



10427

**CIRCUIT TESTER**

10428

Code	Description	Volts (v)	Lead Length (m)
10428	Circuit Tester	6, 12 & 24	1.53

Heavy duty.



10428

**POWER TIMING LIGHTS**

10820-10825

Code	Description	System	Lead Length (mm)
10820	Inductive Pickup	12v	610 - 860
10825	Inductive Pickup With Advanced Check	12v	610 - 860

This timing light operates on all 12 volt electric systems, at all speeds up to maximum of 8000 rpm. It has a detachable clamp-on inductive pick-up for easy and safe hookup. A check light indicates incorrect hook up or faulty flash. Has a replaceable xenon flash tube.



10820 - 10825

**DIGITAL MULTIMETER**

08430

Code	Description	Lead Length (mm)
08430	Digital Multimeter	750

Shock resistant and workshop tough. AC/DC voltage. Resistance to 20M ohm, DC current up to 200mA with battery test. Has a fold out stand to hold the multimeter vertical when in use.



08430



# 15. Automotive & Speciality



10321

## ANGLE DOLLY

10321

Code	Length (mm)	Width (mm)	Depth (mm)	Weight (kg)
10321	115	56	23	.2

Fully polished and treated with anti-rust oil. Made from 1055C medium carbon.



10322

## THIN TOE DOLLY

10322

Code	Length (mm)	Width (mm)	Depth (mm)	Weight (kg)
10322	111	60	12	.6

A flat dolly of metal thinned down at one end and with a curved surface. Useful for getting into awkward and narrow corners. Fully polished and treated with anti-rust oil. Made from 1055C medium carbon.



10323

## DOUBLE HAND END DOLLY

10323

Code	Length (mm)	Width (mm)	Depth (mm)	Weight (kg)
10323	76	62	26	1.2

Fully polished and treated with anti-rust oil. Made from 1055C medium carbon.



10324

## CURVED DOLLY

10324

Code	Length (mm)	Width (mm)	Depth (mm)	Weight (kg)
10324	135	62	45	1.4

Medium weight curved dolly suitable for raising a low spot on a panel. The edge can be used to restore the shape of a roof. Fully polished and treated with anti-rust oil. Made from 1055C medium carbon.



10325

## HEEL DOLLY

10325

Code	Length (mm)	Width (mm)	Depth (mm)	Weight (kg)
10325	90	66	35	1.2

A dolly in the form of a heel of a foot to shape and straighten dented panels. Suitable for reshaping rounded and contoured panels, raising low spots and general panel beating. Fully polished and treated with anti-rust oil. Made from 1055C medium carbon.



10326

## TOE DOLLY

10326

Code	Length (mm)	Width (mm)	Depth (mm)	Weight (kg)
10326	120	60	28	1.3

A flat dolly of metal thinned down at one end and with a curved surface. Useful for getting into awkward and narrow corners. Fully polished and treated with anti-rust oil. Made from 1055C medium carbon.

**PICK AND FINISHING HAMMER**

10305

Code	Description	Handle	Length (mm)	Weight (grams)
10305	Pick and Finishing Hammer	Hickory	325	365

Most popular body shop hammer. Designed to provide excellent balance for close-in work and finishing. Made from 1055C medium carbon.



10305

**LIGHT SHRINKING HAMMER**

10311

Code	Description	Handle	Length (mm)	Weight (grams)
10311	Light Shrinking Hammer	Hickory	325	423

A special hammer with faces shaped to allow for correction of locally stretched sheet metal. When shrinking metal, the panel is beaten into the recesses of the grid, which help stretching. Made from 1055C medium carbon.



10311

**CURVED PEIN FINISH HAMMER**

10312

Code	Description	Handle	Length (mm)	Weight (grams)
10312	Curved Pein & Finishing Hammer	Hickory	325	395

High crowned radius surface and short head for close work on concave and recessed panels. Polished head and hammer cheeks. Made from 1055C medium carbon.



10312

**STRAIGHT PEIN FINISH HAMMER**

10313

Code	Description	Handle	Length (mm)	Weight (grams)
10313	Straight Pein & Finishing Hammer	Hickory	325	393

Crowned face with cross pein end for crease working. Polished head and hammer cheeks. Made from 1055C medium carbon.



10313

**REVERSE CURVE HAMMER**

10314

Code	Description	Handle	Length (mm)	Weight (grams)
10314	Reverse Curve Hammer	Hickory	325	361

High crowned radius surfaces and short head for close work on concave panels. Made from 1055C medium carbon.



10314

# 15. Automotive & Speciality



08419

## GAS SOLDERING IRON TORCH

08419

Code	Description	Watts (w)	Sizes (mm)
08419	Gas Soldering Iron Torch	30 - 125	236 x 32 x 37

Flame temperature 1300°C. Operation time at mid setting is 60mins.

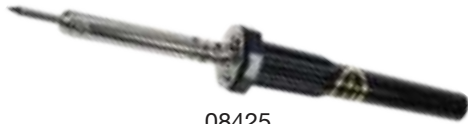

08425

## SOLDERING IRON

08425

Code	Description	Watts (w)	Tip (mm)	Lead Length (m)
08425	Soldering Iron	30	4	1.42



08427

## SOLDERING IRON

08427

Code	Description	Watts (w)	Tip (mm)	Lead Length (m)
08427	Soldering Iron	60	6	1.42



08429

## SOLDERING IRON

08429

Code	Description	Watts (w)	Tip (mm)	Lead Length (m)
08429	Soldering Iron	100	10	1.42





**DOOR HANDLE REMOVER**

08000

Code	Description	Parts	Length (mm)
08000	3 in 1 Door Handle Remover	1	223

A useful tool enabling easy removal of vehicle doors, body clips and headlight lamp springs.



08000

**DOOR HANDLE TOOL**

08001

Code	Description	Parts	Length (mm)
08001	Door Handle Tool	1	178

This tool enables easy removal of the retaining clips holding most vehicle door handles. It has no sharp edges to damage upholstery, and is a comfortable tool to work with.



08001

**UNIVERSAL TRIM TOOL**

08002

Code	Description	Parts	Length (mm)
08002	Universal Trim Tool	1	248

This 10-function trim tool is a multi purpose tool enabling the following: mould and decal removal, door clip removal and insertion, door handle clip removal, door trim clip removal, windscreen clip removal, headlight spring removal, weather strip clip removal and a 13mm wiper nut remover.



08002

**WINDSCREEN REMOVING**

08020

Code	Description	Parts	Length (mm)
08020	Windscreen Removing Tool	1	228

This tool is used to remove windscreens, back lights and bonded back lights. The sealant around the windows is cut by a specially designed tempered steel blade.



08020

**ROTARY SPOT WELD CUTTER**

08030

Code	Description	Size (inch)	Arbor (inch)	Length (mm)
08030	Rotary Spot Weld Cutter	3/8	1/4	75

This spot weld cutter quickly and easily cuts round spot welds on sheet metal. It can also be used to cut small access holes. It has a double ended 3/8" blade, 1/4" arbor and spring loaded pilot point.



08030

# 15. Automotive & Speciality



08028

## LOCKOUT TOOL SET

08028

Code	Description	Parts
08028	Universal Lockout Tool Set	9

A set of lockout tools with a comprehensive set of instructions and diagrams to cover most applications. Set includes a thin bar, wide bar, wire form s-hook, slide lock tool, wonder tool, plastic coat hanger, 2 wedges and a gas cap tool.



08010

## BODY FILLER APPLICATORS

08010

Code	Description	Sizes (mm)
08010	4 Piece Body Filler Applicator Set	25, 50, 75 & 100

Set of four spring steel body filler applicators enabling accurate application of filler whilst minimising wastage.



09200-09202

## WIRE BRUSHES

09200-09202

Code	Description	Wire	Handle
09200	Hand Wire Brush Red Handle	0.3mm Crimped Steel	Plastic
09201	Hand Wire Brush Green Handle	0.3mm Crimped Stainless Steel	Plastic
09202	Hand Wire Brush Yellow Handle	0.3mm Crimped Brass	Plastic



09203

## WIRE BRUSH

09203

Code	Description	Wire	Length (mm)
09203	Hand Wire Brush - 3 Row	Brass, wire & nylon	225



09206

## WIRE BRUSH

09206

Code	Description	Wire	Length (mm)
09206	Hand Wire Brush - 4 Row	Stainless steel	225



09207-09208

## WIRE BRUSH

09207-09208

Code	Description	Wire	Length (mm)
09207	Hand Brush - 3 Row	Steel	350
09208	Hand Wire Brush - 3 Row	Brass, wire & nylon	175

**TWIST KNOT CUP BRUSHES**

09210-09212

Code	Nut Diameter (mm)	Brush Diameter (mm)	Thread
09210	20	65	M10 x 1.25mm
09211	20	65	M10 x 1.5mm
09212	20	65	M14 x 2mm

0.5mm tempered steel wire for use on angle grinders.  
Maximum 12,500 rpm, 65mm Diameter x 20mm.



09210-09212

**CRIMPED STEEL CUP BRUSHES**

09213-09215

Code	Nut Diameter (mm)	Brush Diameter (mm)	Thread
09213	27	75	M10 x 1.25mm
09214	27	75	M10 x 1.5mm
09215	27	75	M14 x 2mm

Brass coated crimped steel wire 0.3mm diameter. Maximum 12,500 rpm, 75mm Dia x 27mm.



09213-09215

**TWIST KNOT BRUSHES**

09240-09242

Code	Nut Diameter (mm)	Brush Diameter (mm)	Thread
09240	13mm	100mm	M10 x 1.25mm
09241	13mm	100mm	M10 x 1.5mm
09242	13mm	100mm	M14 x 2mm

0.5mm tempered steel wire ideal for hard to reach places. Maximum 12,500 rpm, 100mm dia x 13mm.



09240-09242

**BENCH GRINDER BRUSH**

09246

Code	Width (mm)	Diameter (mm)	Arbor Hole (mm)
09246	25	150	32 - 50.8

0.3mm diameter. wire. Brass coated crimped steel wire.  
Maximum 6,000 rpm.



09246-09248

**BENCH GRINDER BRUSH**

09248

Code	Width (mm)	Diameter (mm)	Arbor Hole (mm)
09248	25	200	32 - 50.8

0.3mm diameter. wire. Brass coated crimped steel wire.  
Maximum 4,500 rpm.

**SPRAY GUN**

30203

Code	Description	Nozzle (mm)	Capacity (ml/min)
30203	Spray Gun	1.5 & 2	120 / 180

Produces a high quality spray finish with high speed application and flow rate. Comfortable hand grip.



30203



# 15. Automotive & Speciality



08550

## BRASS CHUCK

08550

Code	Description	Parts	Size
08550	Clip-On Brass Chuck	1	1/4" BSP

This brass airline chuck with a 1/4" BSP fitting clips onto tyre valves.



08552

## STRAIGHT BRASS CHUCK

08552

Code	Description	Parts	Size
08552	Clip-On Brass Chuck	1	1/4"

Straight clip-on type. This brass airline chuck suits a 1/4" diameter rubber airline and clips fast to tyre valves.



08553

## STRAIGHT BRASS CHUCK

08553

Code	Description	Parts	Size
08553	Clip-On Brass Chuck	1	1/4"

Straight clip-on type. This brass airline chuck suits a 1/4" diameter rubber airline and clips fast to tyre valves.



08554

## 45° BRASS CHUCK

08554

Code	Description	Parts	Size
08554	45° Brass Chuck	1	1/4" BSP

This chuck with 1/4" BSP fitting is angled at 45° for easy access to tyre valves. CR-V



08558

## DUAL TYRE CHUCK

08558

Code	Description	Parts	Length (mm)
08558	Dual Tyre Chuck	1	156

Extension arm tyre inflator with angled head for easy access to tyre valve.



10450

## 4 IN 1 TYRE VALVE TOOL

10450

Code	Description	Parts
10450	Tyre Valve Tool 4 in 1	1

4 way tyre valve tool. Removes and installs valve cores.

**DUAL SCALE INFLATOR**

08575

Code	Description	Weight (grams)	PSI	kg/cm <sup>2</sup>
08575	Tyre Inflator	520	0 - 170	0 - 12

Dual scale tyre inflator, lever operated, indicating pressure in PSI and kg/cm<sup>2</sup>.



08575

**QUAD SCALE INFLATOR/DEFLATOR**

08576

Code	Weight (grams)	PSI	kg/cm <sup>2</sup>	Bar	KPa
08576	410	0 - 220	0 - 15	0 - 15	0 - 1500

Quad scale tyre inflator, lever operated, rotary gauge with rubber protector, indicating pressure in psi, kg/cm<sup>2</sup>, bar and KPa.



08576

**SMALL PENCIL TYRE GAUGE**

08566

Code	Description	Parts	PSI	kg/cm <sup>2</sup>
08566	Tyre Gauge	1	0 - 100	0 - 700

Small pencil type tyre gauge with pocket clip, indicates pressure in psi and KPa. Tyre gauges should be used often to maintain optimum tyre pressure which ensures improved vehicle handling and tyre wear. Metal head and body. Chrome finish.



08566

**SMALL PENCIL TYRE GAUGE**

08568

Code	Description	Parts	PSI
08568	Tyre Gauge	1	0 - 50

Small pencil type tyre gauge with pocket clip, indicates pressure in psi. Tyre gauges should be used often to maintain optimum tyre pressure which ensures improved vehicle handling and tyre wear. Metal head and body. Satin finish.



08568

**SMALL DELUXE TYRE GAUGE**

08570

Code	Description	Parts	PSI	kg/cm <sup>2</sup>
08570	Tyre Gauge	1	0 - 100	0 - 4.5

This small deluxe type tyre pressure gauge measures tyre pressure in psi and kg/cm<sup>2</sup> (bar).



08570

**SMALL STANDARD DIAL TYRE GAUGE**

08572

Code	Description	Parts	PSI	kg/cm <sup>2</sup>
08572	Tyre Gauge	1	0 - 65	0 - 4.5

This small standard dial type tyre pressure gauge measures tyre pressure in psi and kg/cm<sup>2</sup> (bar).



08572

# 15. Automotive & Speciality



## MAGNETIC PICK-UP TOOLS

08310-08311

Code	Description	Length (mm)
08310	Magnetic Pick-Up Tool - Telescopic	426 - 680
08311	Magnetic Pick-Up Tool - Telescopic	170 - 620

Double ball joint head swivels to all positions. High power "Alnico" magnet.

## MAGNETIC PICK-UP TOOL

08312

Code	Description	Length (mm)	Weight (grams)
08312	Magnetic Pick-Up Tool - Telescopic	125 - 645	38

Pocket clip. High power "Neodymium Iron Boron" magnet. Made from brass.



## 3 IN 1 MAGNET TOOL SET

08313

Code	Description	Pieces	Pick Up (kg)
08313	3 in 1 Magnetic Pick-Up Set	2	1.6

Includes mirror and magnet with flexible shaft and light. Magnetic pick up to 1.6kg and 450mm long shaft.



## MAGNETIC PICK-UP TOOL

08314

Code	Description	Length (mm)	Pick Up (kg)
08314	Magnetic Pick-Up Tool - Telescopic	170 - 880	1.6

Non-magnetic cover to pick up parts from deep recesses. PVC grip with pocket clip. Pick up objects up to 1.6kg in weight.

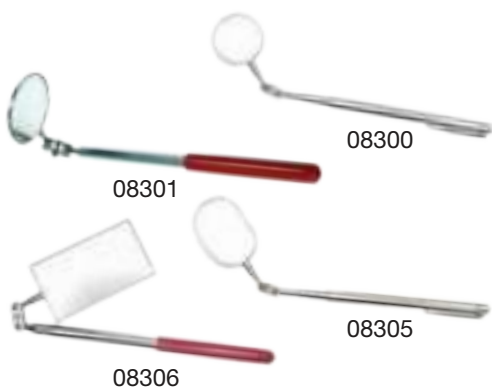

## MIRROR TOOLS

08300-08306

Code	Description	Length (mm)	Mirror Diameter (mm)
08300	Telescopic Mirror Tool	165 - 480	32
08301	Telescopic Mirror Tool	229 - 356	57
08305	Telescopic Mirror Tool	185 - 500	25 x 51
08306	Telescopic Mirror Tool	286 - 387	54 x 89

Double ball joint head swivels to all positions. Oval shape mirror. 58 - 62 HRC.

## MIRROR & MAGNET TOOL SET

08308

Code	Description	Pieces
08308	Telescopic Mirror & Magnet Tool Set	4

The mechanics friend. 4 popular inspection and pick up tools tackle the most common needs of today's mechanic. Set includes 08301, 08300, 08312 & 08310.

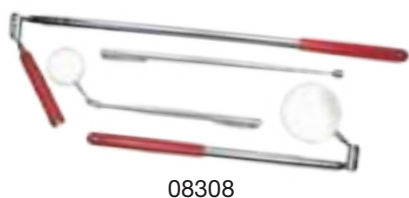



**CLAW TYPE PICK UP TOOL**

19639

Code	Description	Length (mm)
19639	Claw Type Pick Up Tool	600

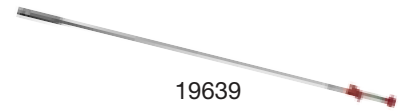

19639

**ENGINEERS STETHOSCOPE**

10412

Code	Description	Parts
10412	Engineers Stethoscope	1

Engineers stethoscopes are useful for locating the source of engine noise. Identify piston slap, worn gears and bearings, faulty valves, water pump failure etc. Trace the sounds of flowing water, oil, gas or steam to identify damaged gaskets etc. Handle is shockproof.



10412

**PARTS CLEANING BRUSH**

08350

Code	Overall Size (mm)	Bristle Length (mm)	Diameter (mm)
08350	285	75	30

Robust parts cleaning brush with stiff HDPE bristles and a plastic handle.



08350

**MAGNETIC PARTS DISH**

08415

Code	Description	Size (mm)	Depth (inch)
08415	Magnetic Parts Dish - Round	150	1-1/8

This magnetic parts dish is made from quality stainless steel and is useful for keeping small parts, hardware and tools exactly where you want them. They can be used in any position, right side up or upside down.



08415

**MAGNETIC PARTS DISH**

08416

Code	Description	Size (mm)	Depth (inch)
08416	Magnetic Parts Dish - Rectangle	240 x 140	1-1/8

This magnetic parts dish is made from quality stainless steel and is useful for keeping small parts, hardware and tools exactly where you want them. They can be used in any position, right side up or upside down. Dual magnets.



08416

**MAGNETIC PARTS DISH**

08417

Code	Description	Size (mm)	Depth (inch)
08417	Magnetic Parts Dish - Rectangle	330 x 250	1-1/8

This magnetic parts dish is made from quality stainless steel and is useful for keeping small parts, hardware and tools exactly where you want them. They can be used in any position, right side up or upside down. Four magnets.



08417

# 15. Automotive & Speciality



## HYDRAULIC PULLER KIT

10702-10703

Code	Description	Piece	Capacity (tonne)	Weight (kg)
10702	Hydraulic Puller Kit	21	10	16
10703	Hydraulic & Manual Puller Kit	22	10	17













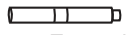

10702 contains a highly versatile 10 tonne capacity hydraulic puller, both 2 & 3 leg pulling in 3 lengths: 100, 150 & 200mm. The kit also contains a large bearing separator (90-105mm) and 2 sets of extension legs giving a reach of 225mm and 450mm.

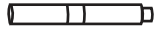
The hydraulic ram extensions have running centres. Made from chrome Molybdenum HRC 40. Puller set is suitable for many automotive, agricultural and industrial pulling applications. Stored in a blow molded case. Please Note; Grease suitable for 10702A Ram; Product No. LA68100, Part No. LPS100, Viscosity ISO100, Using for 2000-3000psi, DIN 51524 part1 & part2, Cincinnati Milacron P-68, Denison HF-O

10703 puller kit contains all the same parts as 10702 but with an additional manual forcing screw (10702S) with running centre and adaptor collar. Made from chrome Molybdenum HRC 40. Stored in a steel case.

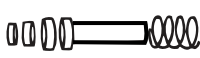
## PARTS FOR 10702

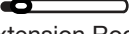
10702A-10708

Code	Pieces	Description	Code	Pieces	Description	Code	Pieces	Description
10702A	1	 Hydraulic Ram	10702F	1	 Triple Head	10702K	1	 Centre Pop
10702B	3	 100mm Legs	10702G	1	 50mm Extension Rod	10702L	1	 Beam
10702C	3	 150mm Legs	10702H	1	 100mm Extension Rod	10702M	1	 Collar
10702D	3	 200mm Legs	10702I	2	 Main Rod 235mm Reach	10702N	1	 Ram Ring
10702E	1	 Twin Head	10702J	2	 Extension Rods 185mm Reach	10708	1	 Bearing Separator



## BEARING SEPARATOR

10705

Code	Description	Capacity (mm)
10705	Bearing Separator	90 - 150

This bearing separator is ideal for removing bearings, gears, collars etc. It comes complete with 2 sets of extension legs giving a reach of 185mm to 435mm. The forcing screw has a running centre to prevent damage to the shaft. To assist with removing press fitted bushes, bearings ball and taper. Includes bearing separator 10708.

## BEARING SEPARATORS

10706-10709

Code	Capacity (mm)	Bolt Diameter	Thread Sizes
10706	30 - 50	3/8" x 24T x L120mm	3/8" x 16 TPI
10707	50 - 75	1/2" x 20T x 135mm	3/8" x 16 TPI
10708	90 - 105	5/8" x 18T x L165mm	12mm x 1.75 pitch
10709	105 - 150	3/4" x 16T x L260mm	5/8" x 11 TPI

All components are interchangeable with 10702. Hardened 42 - 45 HRC. To assist with removing press fitted bushes, bearings balls and taper. Press the sharp edges of the separator behind the bearing attach puller 10705; apply pressure on the centre bolt until bearing is released by turning the centre screw. 10708 Plated and joining bolts, fit onto the bearing.



**BEARING PULLER - MICRO**

10704

Code	Hex Drive	Maximum Capacity	Spread (mm)	Reach (mm)	Weight (kg)
10704	13mm	1 Tonne	19 - 45	73	1.6

This bearing puller is ideally suited to removing small bearings from shafts quickly and easily. Can be driven with a 14mm socket/spanner but in most cases the tommy bar drive is adequate. Fast fit micro puller.



10704

**BEARING PULLER - PILOT**

08110

Code	Description	Range (mm)	Weight (grams)
08110	Pilot Bearing Puller	12 - 38	850

Suitable for most automotive flywheel pilot bearings. Also suitable as bearing and bush puller for generators and starters. Can be used in confined areas. Tommy bar drive is adequate for most applications. Extra force can be applied using a 21mm open end spanner on the collar.



08110

**HUB & DENT PULLER KIT**

10701

Code	Description	Weight (kg)	Storage case
10701	Slide Hammer Hub Puller and Dent Puller	7.1	Steel

Slide hammer kit, plus large and small flange with 2 hub adaptors, European and American flange. This is a multi function slide hammer kit suitable for 2 and 3 leg internal and external pulling applications. Can be used as a bearing puller, pilot bearing puller, bush and oil seal puller and as a dent puller. The hammer is 2.25kg (5lb). Made from Carbon steel. Presented in a heavy duty steel case.



10701

**DENT PULLER KIT**

10720

Code	Description	Parts	Weight (kg)
10720	Dent Puller Kit	10	8.5

A valuable workshop tool with a slide hammer and various hooks to pull dented doors, bumpers, and other sheet metal panels back into place. After drilling a hole in the deepest part of the dent, the hook or screw tip is inserted to pull out the dent by means of slide hammer impact. For use in garage, workshop and by panel beaters. A multi-purpose tool with a variety of uses on auto body repair problems. Presented in a sturdy steel case.



10720



# 15. Automotive & Speciality



10770-10778



**SUPERSEDED**  
Page No. 292

## 2 LEG PULLERS

10770-10778

Code	Size (mm)	Leg Depth (mm)	Capacity (tonne)	Bolt Diameter (mm)	Weight (grams)
10770	75	60	1.5	14	423
10772	100	-	4	17	765
10774	150	-	6	19	1800
10776	200	175	8	22	3700
10777	250	190	10	26	5300
10778	300	215	13	32	8300

Internal and external, long and short reach. Drop forged alloy steel. Use for gears, bearings, pulleys, etc. Made from CR-V 40 - 45 HRC.



10790-10796



**SUPERSEDED**  
Page No. 293

## 2 LEG PULLERS SLIDING ARM TYPE

10790-10796

Code	Size (mm)	Leg Depth (mm)	Capacity (tonne)	Bolt Diameter (mm)	Weight (grams)
10790	80	90	4	17	1050
10792	120	90	4	17	1130
10794	160	140	6	23	2300
10796	200	140	6	23	2600

Internal and external. Drop forged alloy steel. Use for gears, bearings, pulleys, etc. Made from CR-V 40 - 45 HRC.



10780-10789



**SUPERSEDED**  
Page No. 292

## 3 LEG PULLERS

10780-10789

Code	Size (mm)	Leg Depth (mm)	Capacity (tonne)	Bolt Diameter (mm)	Weight (grams)
10780	75	60	2	14	565
10782	100	70	5	17	1000
10784	150	125	7	20	2700
10786	200	175	12	23	5300
10788	250	190	15	26	7700
10789	300	215	18	32	10500

Internal and external, long and short reach. Drop forged alloy steel. Use for gears, pulleys, bearings, etc. Made from CR-V 40 - 45 HRC.



10712

## BALANCER PULLER

10712

Code	Description
10712	Universal Harmonic Balancer Puller

A universal harmonic balancer puller which having both 2 and 3 bolt configuration, fits most popular cars. Made from forged alloy steel and is complete with bolts.



10432

## TIE ROD END LIFTER

10432

Code	Length (mm)	Bolt Length (mm)	Bolt Diameter (mm)	Shaft Diameter (mm)	Weight (grams)
10432	140	65	19	13	920

Screw type. Separates tie rod ends and ball joints from suspension components. Powerful lever action breaks loose most stubborn joints. Works on most tie rod ends and ball joints.

**3 FUNCTION KIT**

10433

Code	Description	Pieces
10433	Tie Rod, Ball Joint & Pitman Arm Tool Kit	5

Tool Kit contains: Tie rod spreader 11/16" wedge opening, Ball joint separator 15/16" jaw opening, Pitman arm wedge 1-1/8" opening, 8" knurled handle to use with hammer and a 0.401" Shank to use with an impact gun.



10433

**SEPARATORS**

10430-10431

Code	Description	Length (mm)	Opening
10430	Ball Joint Separator	300	15/16"
10431	Tie Rod End Separator	405	16.5mm

10430: Drop forged steel construction. Knurled handle for extra grip. Made from heat treated steel to withstand rough usage. Placed between ball joint and steering knuckle and given a few sharp blows with a hammer this tool separates these stubborn parts with ease.

10431: This powerful wedging tool allows fast dismantling of steering linkages. Manufactured from a single piece of alloy steel, precision drop forged and heat treated to withstand professional use.



10430-10431

**COIL SPRING COMPRESSORS**

10409

Code	Description	Size	Pieces
10409	Coil Spring Compressors	1/2" Drive	2

4 jaw type, suits most cars. Set of 2 compressors maintain spring balance. Drop forged steel. Chrome plated compressor jaws. Quick and safe removal or installation of springs while repairing struts.



**SUPERSEDED**  
Page No. 291



10409

**SUMP PLUG REMOVER SET 12PC**

A16002

Code	Description	Weight (grams)
A16002	12 Piece Sump & Differential Plug Remover Set	1180
Hex Sump Plug Removers:		Square Sump Plug Removers:
	8mm	8mm (5/16")
	9mm	11mm
	10mm	13mm
	12mm	17mm
	14mm	3/8"
	3/8"	3/8" T Bar

Made of CR-V to a hardness of 42 - 45 HRC.



A16002

**CLUTCH ALIGNING TOOL**

08111

Code	Description	Rod Length (mm)	Range (mm)	Weight (grams)
08111	Clutch Aligning Tool Metric	1219	12 - 20	377

Includes 7 pilot bush sizes, 2 clutch plates sizes plus a universal taper cone. Aligns clutch plates and pilot bearings.



08111

**CLUTCH ALIGNING TOOL**

08112

Code	Description
08112	Clutch Aligning Tool AF

Includes 10 pilot bush sizes, 12 clutch plates sizes plus a universal taper cone. Aligns clutch plates and pilot bearings.



08112

# 15. Automotive & Speciality



08115

## BEARING & SEAL INSTALLER

08115

Code	Description	Pieces	Sizes	Weight (grams)
08115	Bearing And Seal Installer	7	1 to 6	714

Small to medium. Insert bearings race quickly and straight on first go. Helps to reduce damage to both race and axle housing.



08116

## BEARING & SEAL INSTALLER

08116

Code	Description	Pieces	Sizes	Weight (grams)
08116	Bearing And Seal Installer	10	1 to 9	1900

Small to large. Insert bearings race quickly and straight on first go. Helps to reduce damage to both race and axle housing. Set includes nine disc sizes to fit most standard wheel bearings. Turn the discs over to drive seal.



08334

## SEAL PULLER

08334

Code	Description	Length (mm)	Weight (grams)
08334	Seal Puller	314	380

2 hook sizes to handle most seal sizes. Comfortable moulded handle. For levering stuck seals out of position.



10423

## SEAL PULLER

10423

Code	Description	Length (mm)	Weight (grams)
10423	2 Piece "O" Ring / Oil Pick Set	166 & 180	12

Gets stubborn "O" rings or oil seals out of their seats.



08200

## BEARING PACKER

08200

Code	Working Height Between Cones	Minimum Bearing Capacity (I.D.)	Maximum Bearing Capacity (O.D.)	Weight (grams)
08200	0 - 50mm (0 - 2")	10mm (25/64")	127mm (5-5/16")	390

Operated by air or hand powered grease gun. Zinc plated metal cones. Fast and efficient way to force out old grease and inject fresh grease. Simply place the bearing between the cones, tighten and apply grease through the fitting on the end of the threaded shaft. Use as portable or bench mount. Suits roller and ball bearings.



10460

## PISTON RING COMPRESSOR

10460

Code	Description	Size (mm)	Includes
10460	Piston Ring Compressor	53 - 125	"L" Wrench Tool

Twin band ratchet type. Use compressor to install pistons. To compress piston ring into grooves, slip the tool over the piston and tighten with "L" shaped wrench tool. Insert piston into cylinder and tap to install. Enlarged crimped edge prevents compressor from falling into cylinder.



**WHEEL CYLINDER HONES**

10416-10417A

Code	Description	Legs	Range (mm)
10416	Wheel Cylinder Hone	2	20 - 56
10416A	Wheel Cylinder Hone - Stone Set	2	20 - 56
10417	Wheel Cylinder Hone	3	20 - 56
10417A	Wheel Cylinder Hone - Stone Set	3	20 - 56



10416-10417A

**3 LEG ENGINE CYLINDER HONE**

10418-10418C

Code	Description	Stone Set	Length (mm)
10418	3 Leg Engine Cylinder Hone Stones 50-175mm	Supplied with 10418A	300
10418A	3 Leg Engine Cylinder Hone Stones	Fine	102
10418B	3 Leg Engine Cylinder Hone Stones	Medium	102
10418C	3 Leg Engine Cylinder Hone Stones	Coarse	102



10418-10418C

Adjustable size from 51mm to 177mm. Smooth honing at all speeds. Adjustable spring tension for positive cutting action. Spread limiter permits easy insertion into cylinder.

**VALVE SPRING COMPRESSOR**

08100

Code	Length (mm)	Bolt Diameter (mm)	Arm Length (mm)	Weight (grams)
08100	126	12	100	265

Allows you to remove valve springs without removing the cylinder head. Use in conjunction with 08101 valve holder. Offset jaws grip spring in parallel compression and fit on high performance engines. Hex head allows use of ratchet for confined areas.

Instructions:

- Place jaws under bottom area of valve spring.
- Compress valve spring by turning handle and remove valve keeper.
- Reverse above procedure for installation.

Caution: be sure to use air hold to keep valve in place while working on valve springs.



08100

**VALVE SPRING COMPRESSOR**

08114

Code	Capacity (mm)	Length (mm)	Throat Clearance	Weight (grams)
08114	80 - 135	300	150	1200

Car type.



08114

**VALVE SPRING COMPRESSOR**

08117

Code	Capacity (mm)	Throat Clearance	Weight (grams)
08117	55 - 175	165	2300

Suitable for general use on a wide range of OHC, OHV and CHV engines. Universal model with unique dual cam-action, parallel lift and automatic locking. Reversible jaw/adaptor. Suits multi valve petrol and diesel engines with deep seated valves. Twin lever, twin screw. Collet release adaptors: Restricted access adaptor, 25mm and 30mm.



08117

# 15. Automotive & Speciality



08119

## VALVE SPRING COMPRESSOR

08119

Code	Description	Length (mm)	Throat Clearance	Weight (grams)
08119	Valve Spring Compressor	405	230	2500

Suits large petrol and diesel engines. Jaw opening 35mm minimum to 200mm maximum. Features collet release adaptors.



08122

## COMPRESSION TESTER

08122

Code	Description	Range (PSI)	Hose Length (mm)	Weight (grams)
08122	Compression Tester	0 - 300	315	145

Full 62mm dial. Colour coded quadruple calibrations with 0-300 psi, 21kg/cm<sup>2</sup>, 21 bar and 2100kpa. A long heavy duty flexible hose with a 14mm/18mm adaptor. Convenient pressure holding, side release valve.



08120

## VACUUM & FUEL PUMP TESTER

08120

Code	Description	Hose Length (mm)	Weight (grams)
08120	Vacuum and Fuel Pump Tester	760	153

Full 62mm dial with colour coded scales. A long, flexible heavy duty hose and a universal nose cone adaptor included. Locates leaks in fuel line, vacuum chokes, heating leaks and can highlight valve trouble.



**COMPRESSION TESTER**

08128

Code	Description	Overall Length (mm)	
08128	Diesel Engine - Cars	580	
Gauge Diameter (mm)	Scale	Hose Length (mm)	Weight (grams)
100	0 - 70 Bar 0 - 1000 LB/IN2	355	2500

Comprehensive test kit for both direct and indirect diesel injected engines. Checks engine compression under cranking conditions. Small profile, quick coupling adaptors for speed and security. Built in pressure relief valve enables repeat tests without dismantling. Flexible hose gives access to restricted plug and injector parts. Set includes: 5 glow plug adaptor 52, 72, 73.5, 114.5 and 119mm, 3 dummy injectors 64, 78 and 114mm, stanadyne dummy 112mm, replacement seal and washer set, 90° elbow and a clamp plate 63.5mm.



08128

**OIL PRESSURE TESTER**

08124

Code	Overall Length (mm)	Gauge Diameter (mm)	Scale	Hose Length (mm)
08124	1300	80	0 - 10 Bar	1200

Helps to diagnose worn oil pumps and engines, faulty oil pressure switches and warning indicators. Large clear dual scale gauge. Quick coupling adaptors with shut-off valve for speed and security. Permanently oil primed including a long flexible hose. Set includes: R1/8" DIN 2999, 1/8" x 27NPT, 1/4" x 18NPT, 3/8" x 20UNF, 1/2" x 20UNF, M10 x 10, M12 x 1.5, M14 x 1.5, M16 x 1.5, M18 x 1.5 and a 90° elbow.



08124

**OIL FILTER REMOVER**

08133-08134

Code	Range (mm)	Handle Length (mm)	Weight (grams)
08133	72 - 81	192	257
08134	87 - 97	195	265

Swivel head. Fits most popular car filters.



08133-08134

**UNIVERSAL OIL FILTER REMOVER**

08136

Code	Jaw Capacity (mm)	Drive (inch)	Weight (grams)
08136	Ø62.5 - 99	3/8	246

3 leg flat type. Fits most popular cars and light trucks. Wrench adjusts to fit all spin on type filters. Great for confined areas. Uses soft tips to help grip onto filter. Made of carbon steel with a hardness of HRC 45 degree.



08136



# 15. Automotive & Speciality



08137

## UNIVERSAL OIL FILTER WRENCH

08137

Code	Strap Length (mm)	Handle Length (mm)	Drive (inch)	Weight (grams)
08137	210	150	3/8	325

Fits most filters up to 3-3/4" diameter for most cars and light duty trucks. Nylon strap grips firmly. 3/8" Drive for use with ratchet.



08139

## OIL FILTER REMOVER STRAP WRENCH

08139

Code	Description	Length (mm)	Width (mm)	Weight (grams)
08139	Oil Filter Remover Strap Wrench	150	19	230

Chrome plated steel with a matt finish.



10421-10422

## OIL FILTER REMOVER

10421

Code	Range (mm)	Bolt Diameter (mm)	Drive (inch)	Weight (grams)
10421	45 - 75	21	1/2	600

3 legs. Small to medium type. Can be driven with a 21mm socket/spanner or alternatively using a 1/2" drive ratchet with or without an extension. For use when access to filter is only from the end. Knurled faced legs grip filter firmly.

## OIL FILTER REMOVER

10422

Code	Range (mm)	Bolt Diameter (mm)	Drive (inch)	Weight (grams)
10422	65 - 100	21	1/2	566

3 legs. Medium to large type. Can be driven with a 21mm socket/spanner or alternatively using a 1/2" drive ratchet with or without an extension.



08138

## OIL FILTER REMOVER

08138

Code	Description	Range (mm)	Length (mm)	Weight (grams)
08138	Oil Filter Remover	53 - 118	240	460

"Locks" on to filter. Also grips other irregular shaped items. CR-V jaws.



15110

## STRAP WRENCH

15110

Code	Description	Handle (mm)	Strap (mm)	Weight (grams)
15110	Strap Wrench	300	825	320

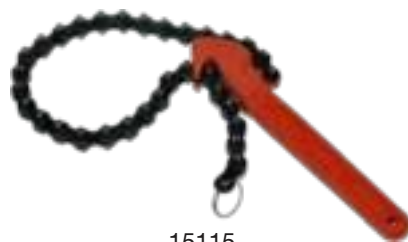

15115

## CHAIN WRENCH

15115

Code	Description	Handle (mm)	Chain (mm)	Weight (grams)
15115	Chain Wrench	150	400	388

Chain has 32 links.

**MINI TUBE CUTTER**

08328

Code	Description	Range (mm)
08328	Mini Tube Cutter	3 - 16

For copper and light alloy pipes. With guide rollers for a smoother more accurate cut.



08328

**TUBE CUTTER**

08329

Code	Description	Range (mm)
08329	Tube Cutter	8 - 28

For copper and light alloy pipes.



08329

**LARGE TUBE CUTTER**

08225

Code	Description	Range (mm)
08225	Large Tube Cutter	6 - 50

For copper and light alloy pipes. Unique ratchet action for fast sizing. Fold out de-burring tool.



08225

**TUBE BENDER**

10435

Code	Description	Range
10435	Tube Bender	6mm (1/4"), 8mm (5/16") & 10mm (3/8")



10435

**4 IN 1 TUBE BENDER**

10436

Code	Description	Range
10436	4 In 1 Tube Bender	4mm (3/16"), 6mm (1/4"), 8mm (5/16") & 10mm (3/8")

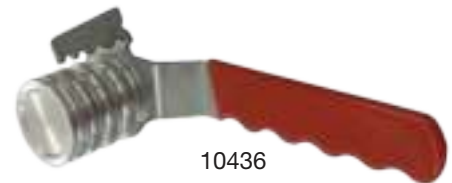

10436

**DOUBLE FLARING TOOL SET**

08220

Code	Description	Capacity (inch)	Weight (grams)
08220	Double Flaring Tool Set	1/8 - 1/2	1700

Includes an 08225 pipe cutter.



08220

# 15. Automotive & Speciality



08205

## BRAKE HOSE CLAMP

08205

Code	Description	Length (mm)	Weight (grams)
08205	Brake Hose Clamp	166	13

Seals flexible brake and fuel lines. Smooth rounded edges to ensure no damage to the internal reinforcement of hydraulic brake lines.



08206

## BRAKE HOSE CLAMP SET 3PC

08206

Code	Description	Pieces	Sizes (mm)
08206	Flexible Line Clamp Set	3	150, 180 & 250

Seals brake hose, fuel hose, heater hose, etc.



08165

## HOSE PINCHERS 2PC

08165

Code	Description
08165	2 Piece Vacuum Line, Fuel Line and Hose Pinchers

Pinch off vacuum lines, fuel lines and hoses. Prevents leakage, will not damage hoses and are easy to use.



08207

## ONE MAN BRAKE BLEEDER

08207

Code	Description	Tube Length (mm)
08207	One Man Brake Bleeder	166 & 488

Handles both master, slave and wheel cylinders. Tapered plugs suit all bleed screw fittings. Magnet holds bottle above cylinder for positive sealing with no air re-entry.



40024-40026

## BRAKE ADJUSTING TOOLS

40024-40026

Code	Sizes (mm)	Length (mm)	Weight (grams)
40024	13	197	70
40026	8	122	30

45 Carbon steel 35-45 HRC.



08203

## BRAKE SPRING TOOL

08203

Code	Description	Length (mm)	Weight (grams)
08203	Brake Spring Tool	235	150

For easy brake re-assembly.



08202

## BRAKE SPRING COMPRESSOR 3PC

08202

Code	Head Lengths (mm)	Handle Length (mm)	Overall Length (mm)	Weight (grams)
08202	93 & 110	90	234	166

Zinc plated to resist corrosion. Tough, easy grip with aluminium handle. Removes and installs backing plates, springs, cups and pins.



**DISC BRAKE SPREADER**

08209

Code	Description	Range (mm)	Length (mm)	Weight (grams)
08209	Disc Brake Spreader	18 - 114	140	233

Durable, heavy duty construction compresses inner pad and resets piston for easy pad replacement.

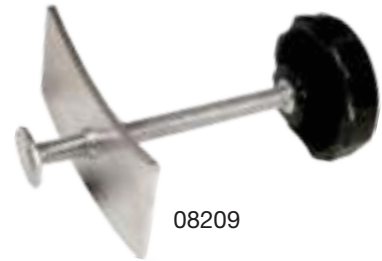

08209

**BREAK PISTON SEPARATOR TOOL**

08214

Code	Description
08214	Break Piston Separator Tool

Fits in break caliper to push back pistons for new brake pad installation. An essential tool for retraction to brake piston to allow insertion of new brake pad. Suitable for most callipers



08214

**RADIATOR FIN STRAIGHTENING TOOL**

10451

Code	Description
10451	Radiator Fin Straightening Tool

Cleans and straightens condenser and evaporator fins. Six sided head for 8, 9, 10, 12, 14 and 15 fins per inch applications.



10451

**SAFETY GLASSES**

08320

Code	Description
08320	Safety Glasses



08320



# 16. Garage & Workshop Equipment



**Fully  
equipped  
for any  
workshop.**



KC Tools garage and workshop equipment feature a wide range of quality designed garage equipment and specialised tools aimed at reducing your work time and getting the job done efficiently. We've got creepers, trolleys, drill presses, vices, tap and die sets and torches. We guarantee quality products that not only help you get the job done, but make the job easier! Our garage equipment tools carry our 'Hassle Free" warranty against any failure due to faulty workmanship or materials. So get started!

Our complete range of garage and workshop equipment ensures you are fully equipped to tackle any job, keeping all your tools right within reach.





# 16. Garage & Workshop Equipment



JS2000-JS6000

## AXLE STAND

JS2000-JS6000

Standards:		AS2538:2004			
Code	Capacity (kg)	Min Height (mm)	Max Height (mm)	Weight (kg)	
JS2000	2000	288	430	7	
JS4000	4000	390	608	14	
JS6000	6000	460	720	28	

Ratchet type axle stands, High quality steel construction. An absolute necessity when working under a vehicle raised by a floor jack. Quality, strength and dependability.



BJ2000W-BJ20000W

## BOTTLE JACKS

BJ2000W-BJ20000W

Standards:		AS/NZS2693:2007			
Code	Capacity (kg)	Min Height (mm)	Max Height (mm)	Adjusting Height (mm)	Weight (kg)
BJ2000W	2000	190	368	60	3
BJ4000W	4000	210	407	70	5
BJ6000W	6000	225	440	80	5
BJ8000W	8000	230	465	80	7
BJ10000W	10000	230	460	80	8
BJ15000W	15000	240	450	60	11
BJ20000W	20000	260	420	-	18

Industrial series jacks feature high quality steel construction. Have an "easy to carry" handle.



SQBJ12000-SQBJ20000

## SQUAT BOTTLE JACKS

SQBJ12000-SQBJ20000

Standards:		AS/NZS2693:2007			
Code	Capacity (kg)	Min Height (mm)	Lifting Height (mm)	Adjusting Height (mm)	Weight (kg)
SQBJ12000	12000	191	296	70	8
SQBJ20000	20000	191	306	70	10

Industrial series jacks feature high quality steel construction. Have an "easy to carry" handle.



FJ1

## FARM JACK

FJ1

Standards:		AS/NZS2693:2007			
Code	Capacity (kg)	Min Height (mm)	Max Height (mm)	Sizes (mm)	Weight (kg)
FJ1	1250	154	1070	1235x245x140	14

Can be used for such applications as lifting, winching, clamping, pushing and pulling. It is this versatility, along with the long travel it offers, and its relative portability which makes the farm jack popular with off road drivers. Mitsu 48"/120cm High lift jack.

**TROLLEY JACK**

TJ1550

Standards:		AS/NZS2615:2004		
Code	Capacity (kg)	Min Height (mm)	Lifting Height (mm)	Weight (kg)
TJ1550	1550	130	390	17

Rapid lift, heavy duty cast iron pump and flared side rotating saddle. Detachable handle for easy storage.



TJ1550

**TROLLEY JACK**

TJ2250

Standards:		AS/NZS2615:2004		
Code	Capacity (kg)	Min Height (mm)	Lifting Height (mm)	Weight (kg)
TJ2250	2000	145	500	38

Rapid lift, heavy duty cast iron pump and flared side rotating saddle. Detachable handle for easy storage. Easy to use foot pump.



TJ2250

**LOW PROFILE STEEL JACK**

TJ2000

Code	Capacity (kg)	Min Height (mm)	Max Height (mm)	Weight (kg)
TJ2000	2000	82	455	34

Low profile steel jack for use on lowered vehicles. detachable handle for easy storage.



TJ2000

**LOW PROFILE RACING JACK**

TJ2000A

Code	Capacity (kg)	Min Height (mm)	Max Height (mm)	Weight (kg)
TJ2000A	2000	100	460	27

Rapid lift with dual pump, low profile Jack for use on lowered Vehicles. detachable handle for easy storage.



TJ2000A

**TRANSMISSION JACK**

TJF01

Code	Capacity (kg)	Min Height (mm)	Max Height (mm)	Weight (kg)
TJF01	500	220	575	35.5

Professional quality. Low profile floor type. Universal saddle brackets and chain slings which are adjustable to fit transmissions, clutches and differentials in varying sizes. Rugged construction allows jack and load to be moved around workshop easily and safely in the lowered position.



TJF01

# 16. Garage & Workshop Equipment



TJV01

## TRANSMISSION JACK

TJV01

Code	Capacity (kg)	Min Height (mm)	Max Height (mm)	Weight (kg)
TJV01	500	1260	1745	32.5

Professional quality. Tall vertical type. Universal saddle brackets and chain slings which are adjustable to fit transmissions, clutches and differentials in varying sizes. Rugged construction allows jack and load to be moved around workshop easily and safely in the lowered position.



LL01

## LOAD LEVELLER

LL01

Code	Capacity (kg)	Adjustment Range Of Threaded Rod (mm)	Weight (kg)
LL01	680	250	5.5

Attachment is capable of being adjusted to change the angle of the load being lifted. Threaded adjuster rod with crank alters the lifting centre to change the angle or weight balance.



PB01

## HYDRAULIC PIPE BENDERS

PB01-PB02

Code	Capacity (tonne)	Ram Stroke	Shoe Sizes	Bending Dies	Weight (kg)
PB01	12	150mm	15 - 50mm	1/2", 3/4", 1", 1-1/4" & 1-1/2"	39
PB02	15	150mm	15 - 75mm	1/2", 3/4", 1", 1-1/4", 1-1/2", 2", 2-1/2" & 3"	57.5

Return spring on ram. Works in both vertical and horizontal positions. Maximum 5mm pipe thickness, Max. Diameter is 75mm. Ideal for pipe benders and general engineering applications.



PB02



**SHOP PRESSES**

SP12-SP20

Code	Capacity (tonne)	Stroke (mm)	Working Area	Bed Width (mm)	Weight (kg)
SP12	12	150	170 x 410	410	43
SP20	20	160	200 x 450	620	102

Various working positions. Designed for automotive, truck and industrial repair shop work such as bending, straightening, folding and punching. Ideal for the removal and installation of bolts, bearings, gears, etc.



SP12-SP20

SP40

**SHOP PRESS**

SP40

Code	Capacity (tonne)	Stroke (mm)	Working Area	Bed Width (mm)	Weight (kg)
SP40	40	180	600 x 325	655	216

Hydraulic and pneumatic. Air pressure 120-200PSI. Various working positions. Designed for automotive, truck and industrial repair shop work such as bending, straightening, folding and punching. Ideal for the removal and installation of bolts, bearings, gears, etc.

**RETRACTABLE AIR HOSE REEL**

AH12

Code	Description	Capacity (PSI)	NPT (inch)	Length (ft)
AH12	Retractable Air Hose Reel	300	1/2	50

The reel assembly is made of heavy gauge steel and has a heavy duty 1/2" / 13mm internal diameter rubber air hose. 8 position ratchet gearing, locks reel at desired hose length. Has a slotted mounting base to easily fix onto ceilings, walls, work benches or vehicles. 5 position adjustable roller. Outlet arm. Not for use with welding, motor oil or chassis grease service.



AH12

**SWIVEL BRACKET**

AH12B

Code	Description	Size (mm)
AH12B	Swivel Bracket suited for AH12	100 x 60

Black swivel bracket to suite AH12, Retractable Air Hose Reel.



AH12B

**PARTS WASHER**

PW01

Code	Capacity (litre / gallon)	Pcs/ctn (mm)	Pump Output (LPM)
PW01	75.7 / 20	750 x 520 x 270	9.45

Work Pressure (MPA)	Weight (kg)
0,45-0,65	25

240v Pump. Parts washer has a wide range of applications for washing and cleaning various parts. Flexible snake-tube that will adjust to a variety of positions. Large cleaning volume. Holds up to 70% liquid. Only use water based liquids. Do not use solvents.



PW01

PW02

**PARTS WASHER**

PW02

Code	Capacity (litre / gallon)	Pcs/ctn (mm)	Pump Output (LPM)	Weight (kg)
PW02	151.4 / 40	1000 x 1000 x 6000	5 - 8	40

240v Pump. Parts washer has a wide range of applications for washing and cleaning various parts. Flexible snake-tube that will adjust to a variety of positions. Large cleaning volume. Holds up to 70% liquid. Only use water based liquids. Do not use solvents.

# 16. Garage & Workshop Equipment



SBC03

## SANDBLAST CABINET

SBC03

Code	Description	Sizes (mm)	Working Space (mm)
SBC03	Sandblast Cabinet Bench Type	630 x 530 x 480	560 x 460 x 280
Weight (kg)	Air Pressure	Abrasive Capacity	
30	100 PSI	23kg	

Removes paint, surface rust and oxidation. Perspex viewing panel. Inbuilt 220v light to improve visibility during operation. Grit not included.



SB10G

## SANDBLAST UNIT

SB10G

Code	Capacity (litre / gallon)	Tank Sizes (mm)	Overall Sizes (mm)	
SB10G	37.85 / 10	300 x 500	830 x 480 x 330	
Hose Length (m)	Work Pressure	Weight (kg)	CFM	Nozzles sizes (mm)
2.5	60 -125 PSI	19	6-25	2.5, 3, 3.5 & 4

Pressurised design for 30% more blasting power than siphon units. Provides more abrasive when you need a more efficient performance. Equipped with a ceramic nozzle and shut-off valve, pressure gauge, 2.5 metre hose, filling funnel, water trap, 6" wheels and a canvas hood. Grit not included.

## CERAMIC NOZZLE

SB10GN

Code	Description	Size (mm)
SB10GN	Ceramic Nozzle to Suite SB10G	730 x 425 x 540

SB10GN



DT100

## OIL DRAIN TANK

DT100

Code	Capacity (litre / gallons)	Overall size (mm)	Weight (kg)
DT100	75.7 / 20	730 x 425 x 540	21

Air operated to drain storage tank. Has 4 wheels for easy manoeuvrability around the workshop.



GC01

## CREEPER

GC01

Code	Description	Overall Size (mm)	Weight (kg)
GC01	Metal Profile	1030 x 440 x 105	6.5

Heavy duty low profile design. Shoulder cut out. Features 6 casters, vinyl covered body and padded headrest.



10835

## CREEPER

10835

Code	Description	Casters	Length (mm)	Width (mm)
10835	Plastic Profile	6 x Heavy Duty, 2 Fasteners	1010	490

Incorporates 2 tool storage recesses on sides and heavy duty caster wheels. Padded headrest.

**ROUND ADJUSTABLE CREEPER SEAT** 10829

Code	Description	Casters	Height (mm)	Weight (kg)
10829	Creeper Seat	5	575	5.7

Contains a tool storage area underneath seat for work tools. Easy to manoeuvre around work area. Padded top. 5 casters. Made from carbon steel.



10829



10830

**STEEL CREEPER SEAT** 10830

Code	Description	Casters	Size (mm)	Weight Capacity (kg)
10830	Steel Creeper Seat	4 x 63.5mm	440 x 360 x 360	113

High impact PVC pan for tool storage. Durable steel frame. Ideal for long jobs under the vehicle.

**TOOL TROLLEY** TT01

Code	Description	Height (mm)	Width (mm)
TT01	Tool Trolley	800	370

Multi-use tool trolley with 3 trays. Lockable casters. Easy to manoeuvre around the workshop. Trolley comes flat packed and is easy to assemble.



TT01

**TOOL TROLLEY** TT03

Code	Description	Height (mm)	Width (mm)
TT03	Tool Trolley	800	380

Tool trolley with 2 trays, 1 drawer and a flat top. Lockable 100mm casters. Easy to manoeuvre around the workshop. Trolley comes flat packed and is easy to assemble.



TT03

**TOOL TROLLEY** TT04

Code	Description	Height (mm)	Width (mm)
TT04	Tool Trolley	710	370

Tool trolley with 1 trays, 2 drawer and a moving top. Lockable 100mm casters. Easy to manoeuvre around the workshop. Trolley comes flat packed and is easy to assemble.



TT04



# 16. Garage & Workshop Equipment



DP1F

## DRILL PRESS, FLOOR TYPE

DP1F

Code	Description	Sizes (mm)	Table Size (mm)	Spindle Speeds
DP1F	Drill Press Floor Type 3/4HP, 16 Speed	755 x 355 x 1655	340	200-2600
Weight (kg)	Max. Drilling Capacity (mm)	Working Height With Table (mm)	Chuck Size (mm)	Morse Taper Shank Size
98	800	210	25	#2

An essential tool for drilling precisely spaced holes or boring to exact depths. With the right setup you can bore at almost any angle without fear of the drill bit moving or reaming the hole 'out of round'. A drill press is an excellent investment for any workshop. Angled working plate.



BG200

## BENCH GRINDER

BG200

Code	Capacity (mm)	Stone (grit)	Grinding wheels (mm)	Hole size (mm)	Motor size (hp)	Weight (kg)
BG200	200	1 Fine & 1 Coarse	20 x 200	16	1	6

Heavy duty grinder. Low maintenance induction motor. Adjustable tool rests. Cast iron housing. Protective steel covers. Eye guards.



08680-08686

## STEEL VICE

08680-08686

Code	Description	Size (inch)
08680	Steel Vice	4
08682	Steel Vice	6
08684	Steel Vice	8
08686	Steel Vice	10

Swivel base.



15230-15232

## DRILL VICE

15230-15232

Code	Description	Size (mm)
15230	Drill Vice	75
15232	Drill Vice	100

**OIL SYRINGE**

10295

Code	Description	Capacity (cc)
10295	Oil Syringe	500

Ideal for topping up and draining gearboxes, differentials etc.



10295

**GREASE GUN**

10485

Code	Description	Capacity (cc)
10485	Lever Type Grease Gun	500

Takes a standard 16oz cartridge. Pressure or bulk fill.



10485

**CORDLESS GREASE GUN**

10490

Code	Description	Capacity (cc)
10490	Cordless Grease Gun	500

Takes a standard 16oz cartridge. Pressure or bulk fill.



10490

**DRUM PUMP**

10470

Code	Capacity (litre)	Drum size (litre / gallons)	Bung Size (mm)
10470	1 per 3 Revs	56.7L / 15Gal, 113.5L / 30Gal, 208.1L / 55Gal	50

This drum pump has a cast iron body with steel inlet and discharge tubes. It is used for pumping non-corrosive petroleum based fluids such as diesel, kerosene, transmission fluids, machine oils, lubrication oils and the like. It is not suitable for petrol, water based fluids organic solvents, strong acids or alkalis. Ideally suited for industrial, agricultural and automotive applications, it fits neatly on standard drums, and is self priming. Not suitable for petrol.



10470

**DRUM PUMP**

10473

Code	Capacity (litre)	Drum size (litre / gallons)	Bung Size (mm)
10473	1 per 3 Revs	56.7L / 15Gal, 113.5L / 30Gal, 208.1L / 55Gal	50

This pump is excellent for transferring low viscosity and non-corrosive petroleum based fluids such as petrol, kerosene, lubrication oils, fuel and machine oils, etc. Clockwise and anti-clockwise operation for ease of use. Vertical transfer distance up to 15 metres, horizontal transfer up to 50 metres. Suitable for petrol.



10473

**DRUM PUMP**

10478

Code	Capacity (litre)	Drum size (litres / gallons)
10478	1 per 3 Revs	200 / 52.8

This pump suits oils, diesel etc. 6 month lifetime for petrol. Suitable for petrol.



10478

# 16. Garage & Workshop Equipment



10370

## BODY REPAIR KIT

10370

Code	Description	Capacity (tonne)
10370	Body Repair Kit	10

For use in the garage, workshop and panel beaters. This multi-purpose hydraulic kit manufactured from high quality steel contains all you need for lifting, pulling, bending, pushing and straightening.

All components are specifically designed to make such tasks easy and to achieve precision results.

Contents: 1 x 10 Tonne pump, 1 x hose, 1 x ram, 1 x wedge ram, 4 x extensions, 1 x extension joiner,

7 x ends to suit a variety of positions and applications.

Components are manufactured from high quality steel.

Presented in a strong steel case.



10371

## 10 TONNE PUMP

10371

Code	Description
10371	10 Tonne Pump (to suit 10370)



10372

## RAM

10372

Code	Description
10372	Ram (to suit 10370)



10373

## SPREADER RAM

10373

Code	Description
10373	Spreader Ram (to suit 10370)



10374-10375

## 10 TONNE PUMP, HOSE & RAM

10374-10375

Code	Description
10374	Spreader Ram (to suit 10370)
10375	Spare Hose (to suit 10370)



10376

## HOSE COUPLER RAM END

10376

Code	Description
10376	Hose Coupler Ram End (to suit 10370)



10377

## HALF COUPLER HOSE END

10377

Code	Description
10377	Half Coupler Hose End (to suit 10370)

## RELEASE VALVE STEM

10378

Code	Description
10378	Release Valve Stem (to suit 10370)

## REPAIR KIT

10379

Code	Description
10379	Repair Kit (to suit 10370)



**PORTA POWER**

C057

Code	Capacity (tonne)	Minimum Ram Height (mm)	Ram lifting Height (mm)	Weight (kg)
C057	10	460	150	51

2 - stage piston, solid blow moulded case with wheels. Complete kit contains all you need for lifting, pushing, bending, pulling, straightening, and spreading. Multitude of uses in construction, repair and auto works. Contains: Spreader wedge, 4 extension bars, serrated cap, ram toe, plunger toe, cleft toe, v base, base plate and a big rubber head.



C057

**HAND RIVETER KIT**

10631

Code	Description	Length (mm)	Die Sizes (mm)
10631	Hand Riveter Kit	260	2.4, 3, 4 & 5

Complete kit with aluminium rivets. For aluminium rivets only.



10631

**HAND RIVETER**

10632

Code	Description	Length (mm)	Die Sizes (mm)
10632	Heavy Duty Hand Riveter	250	3.2, 4 & 4.8

Sturdy construction. CR-V operating lever. Works with aluminium rivets. For aluminium rivets only.



10632

**HAND RIVETER**

10633

Code	Description	Length (mm)	Handle (mm)	Die Sizes (mm)
10633	Lever Type Hand Riveter	245	385	3.2, 4, 4.8 & 6.4

Compound action and spring return make this an easy to use riveter. Can take aluminium & SS rivets.

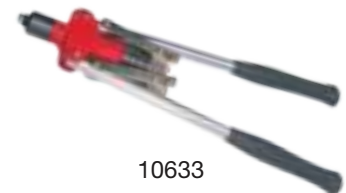

10633

**LAZY TONG HAND RIVETER**

10634

Code	Description	Length Open	Length Closed	Die Sizes (mm)
10634	Lazy Tong Hand Riveter	830	310	3.2, 4, 4.8, 6 & 6.4

Suitable for heavy duty and repetitive type riveting. Works with aluminium rivets. For aluminium rivets only.

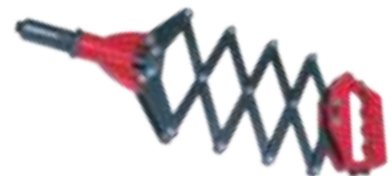

10634

# 16. Garage & Workshop Equipment

## THREAD FORM SYMBOLS

Symbol	Metric Drill
ACME-C	Acme Thread-Centralizing
ACME-G	Acme Thread-General Purpose
AMO	American Standard Microscope Objective Thread
ANPT	Aeronautical National Form Taper Pipe Thread(Ground thread tap marked NPT)
BA	British Association Standard Thread
BSF	British Standard Fine Thread Series
BSPP	British Standard Pipe (Parallel) Thread
BSPT	British Standard Taper Pipe Thread
M	Metric Screw Thread Series
N	American National 8, 12 and 16 Thread Series (8N, 12N, 16N)
N BUTT	American Buttress Screw Thread
NC	American National Coarse Thread Series
NEF	American National Extra Fine Thread Series
NF	American National Fine Thread Series
NGO	National Gas Outlet Thread
NGT	National Gas Taper Thread (see "SGT")
NH	American National Hose Coupling and Fire Hose Coupling Threads
NPS	For tap marking only (See NPSC, NPSM)
NPSC	American National Standard Straight Pipe Thread in Pipe Couplings (Tap marked NPS)
NPSF	Dry seal American National Standard Fuel Internal Straight Pipe Thread
NPSH	American National Standard Straight Pipe Thread for Hose Couplings
NPSI	Dry seal American National Standard Intermediate Internal Straight Pipe Thread
NPSL	American National Standard Straight Pipe Thread for Loose Fitting Mechanical Joints with Locknuts
NPT	American National Standard Taper Pipe Thread (See ANPT, NPTR)
NPTF	Dryseal American National Standard Taper Pipe Thread
UN	Unified Constant Pitch Thread Series
UNC	Unified Coarse Thread Series
UNF	Unified Fine Thread Series
UNJ	Unified Thread Series with a 0.15011P to 0.18042P Controlled Root Radius on External Thread only.
UNJC	Unified Coarse Thread Series with a 0.15011P to 0.18042P Controlled Root Radius on External Thread only.
UNR	Unified Constant Pitch Thread Series with a 0.108P to 0.144P Controlled Root Radius; Ext. thread only.
V	A 60; "V" thread with Truncated Crest and Root. The theoretical "V" Form is usually flatted to the user's specifications.



**TAP & DIE SET 110PC**

PT52



Tap Sizes Ø	Die Sizes	Die Diameter Ø	Pitch	Tapping Length	Drill Size
<b>Metric Sizes:</b>					
6mm Starter	-	-	1.0mm	24mm	5.0mm
6mm Finisher	6mm	25mm	1.0mm	24mm	5.0mm
8mm Starter	-	-	1.25mm	30mm	6.8mm
8mm Finisher	8mm	25mm	1.25mm	30mm	6.8mm
10mm Starter	-	-	1.5mm	32mm	8.0mm
10mm Finisher	10mm	25mm	1.5mm	32mm	8.0mm
10mm Starter	-	-	1.75mm	32mm	8.5mm
10mm Finisher	10mm	25mm	1.75mm	32mm	8.5mm
11mm Starter	-	-	1.75mm	36mm	9.3mm
11mm Finisher	11mm	25mm	1.75mm	36mm	9.3mm
12mm Starter	-	-	1.75mm	38mm	10.3mm
12mm Finisher	12mm	32mm	1.75mm	38mm	10.3mm
12mm Starter	-	-	1.25mm	38mm	10.2mm
12mm Finisher	12mm	32mm	1.25mm	38mm	10.2mm
14mm Starter	-	-	1.25mm	39mm	12.0mm
14mm Finisher	14mm	32mm	1.25mm	39mm	12.0mm
18mm Starter	-	-	1.5mm	41mm	15.5mm
18mm Finisher	18mm	32mm	1.5mm	41mm	15.5mm
<b>UNC Sizes:</b>					
1/4" Starter	-	-	20 TPI	24mm	#7 5.1mm
1/4" Finisher	1/4"	25mm	20 TPI	24mm	#7 5.1mm
5/16" Starter	-	-	18 TPI	30mm	17/64" 6.5mm
5/16" Finisher	5/16"	25mm	18 TPI	30mm	17/64" 6.5mm
3/8" Starter	-	-	16 TPI	35mm	5/16" 7.9mm
3/8" Finisher	3/8"	25mm	16 TPI	35mm	5/16" 7.9mm
7/16" Starter	-	-	14 TPI	38mm	3/8" 9.4mm
7/16" Finisher	7/16"	25mm	14 TPI	38mm	3/8" 9.4mm
1/2" Starter	-	-	13 TPI	42mm	27/64" 10.7mm
1/2" Finisher	1/2"	32mm	13 TPI	42mm	27/64" 10.7mm
9/16" Starter	-	-	12 TPI	42mm	31/64" 12.2mm
9/16" Finisher	9/16"	32mm	12 TPI	42mm	31/64" 12.2mm
5/8" Starter	-	-	11 TPI	42mm	17/32" 13.5mm
5/8" Finisher	5/8"	32mm	11 TPI	42mm	17/32" 13.5mm
3/4" Starter	-	-	10 TPI	50mm	21/32" 16.5mm
3/4" Finisher	3/4"	32mm	10 TPI	50mm	21/32" 16.5mm
#4 Starter	-	-	40 TPI	16mm	#43 2.3mm
#4 Finisher	#4	25mm	40 TPI	16mm	#43 2.3mm
#6 Starter	-	-	32 TPI	18mm	#36 2.7mm
#6 Finisher	#6	25mm	32 TPI	18mm	#36 2.7mm
#8 Starter	-	-	32 TPI	20mm	#29 3.45mm
#8 Finisher	#8	25mm	32 TPI	20mm	#29 3.45mm
#10 Starter	-	-	24 TPI	22mm	#25 3.8mm
#10 Finisher	#10	25mm	24 TPI	22mm	#25 3.8mm
#12 Starter	-	-	24 TPI	22mm	#16 4.5mm
#12 Finisher	#12	25mm	24 TPI	22mm	#16 4.5mm
<b>UNF Sizes:</b>					
1/4" Starter	-	-	28 TPI	24mm	#3 5.4mm
1/4" Finisher	1/4"	25mm	28 TPI	24mm	#3 5.4mm
5/16" Starter	-	-	24 TPI	30mm	17/64" 6.9mm
5/16" Finisher	5/16"	25mm	24 TPI	30mm	17/64" 6.9mm
3/8" Starter	-	-	24 TPI	35mm	21/64" 8.4mm
3/8" Finisher	3/8"	25mm	24 TPI	35mm	21/64" 8.4mm
7/16" Starter	-	-	20 TPI	38mm	25/64" 9.9mm
7/16" Finisher	7/16"	25mm	20 TPI	38mm	25/64" 9.9mm
1/2" Starter	-	-	20 TPI	42mm	29/64" 11.5mm
1/2" Finisher	1/2"	32mm	20 TPI	42mm	29/64" 11.5mm
9/16" Starter	-	-	18 TPI	42mm	33/64" 12.8mm
9/16" Finisher	9/16"	32mm	18 TPI	42mm	33/64" 12.8mm
5/8" Starter	-	-	18 TPI	42mm	37/64" 14.5mm
5/8" Finisher	5/8"	32mm	18 TPI	42mm	37/64" 14.5mm
3/4" Starter	-	-	16 TPI	51mm	11/64" 17.5mm
3/4" Finisher	3/4"	32mm	16 TPI	51mm	11/64" 17.5mm
#10 Starter	-	-	32 TPI	22mm	#21 4mm
#10 Finisher	#10	25mm	32 TPI	22mm	#21 4mm
<b>UNS Sizes:</b>					
1/4" Starter	-	-	24 TPI	28mm	5.3mm
1/4" Finisher	1/4"	25mm	24 TPI	28mm	5.3mm
1/4" Starter	-	-	40 TPI	26mm	5.6mm
1/4" Finisher	1/4"	25mm	40 TPI	26mm	5.6mm
<b>NPT Sizes:</b>					
1/8" Starter	-	-	27 TPI	55mm	8.7mm
1/8" Finisher	1/8"	25mm	27 TPI	55mm	8.7mm
1/4" Starter	-	-	18 TPI	27mm	11mm
1/4" Finisher	1/4"	25mm	18 TPI	27mm	11mm



PT52



# 16. Garage & Workshop Equipment

## TAP & DIE SET 110PC

PT52M



PT52M

Tap Sizes Ø	Die Sizes	Pitch	Tapping Length	Drill Size
<b>Metric Sizes:</b>				
2mm Starter	-	0.4	19mm	1.6mm
2mm Finisher	2mm	0.4	19mm	1.6mm
3mm Starter	-	0.5	20mm	2.5mm
3mm Finisher	3mm	0.5	20mm	2.5mm
4mm Starter	-	0.7	22mm	3.3mm
4mm Finisher	4mm	0.7	22mm	3.3mm
5mm Starter	-	0.8	24mm	4.2mm
5mm Finisher	5mm	0.8	24mm	4.2mm
6mm Starter	-	0.75	29mm	5.3mm
6mm Finisher	6mm	0.75	29mm	5.3mm
6mm Starter	-	1.0	29mm	5.0mm
6mm Finisher	6mm	1.0	29mm	5.0mm
7mm Starter	-	0.75	26mm	6.3mm
7mm Finisher	7mm	0.75	26mm	6.3mm
7mm Starter	-	0.1	26mm	6.0mm
7mm Starter	7mm	0.1	26mm	6.0mm
8mm Starter	-	0.75	25mm	7.3mm
8mm Finisher	8mm	0.75	25mm	7.3mm
8mm Starter	-	1.0	30mm	7.0mm
8mm Finisher	8mm	1.0	30mm	7.0mm
8mm Starter	-	1.25	30mm	6.7mm
8mm Finisher	8mm	1.25	30mm	6.7mm
9mm Starter	-	0.75	25mm	8.3mm
9mm Finisher	9mm	0.75	25mm	8.3mm
9mm starter	-	1.0	30mm	8.0mm
9mm Finisher	9mm	1.0	30mm	8.0mm
9mm Starter	-	1.25	30mm	7.7mm
9mm Finisher	9mm	1.25	30mm	7.7mm
10mm Starter	-	0.75	25mm	9.3mm
10mm Finisher	10mm	0.75	25mm	9.3mm
10mm Starter	-	1.0	30mm	9.0mm
10mm Finisher	10mm	1.0	30mm	9.0mm
10mm Starter	-	1.25	35mm	8.7mm
10mm Finisher	10mm	1.25	35mm	8.7mm
10mm Starter	-	1.5	35mm	8.5mm
10mm Finisher	10mm	1.5	35mm	8.5mm
11mm Starter	-	0.75	25mm	10.3mm
11mm Finisher	11mm	0.75	25mm	10.3mm
11mm Starter	-	1.0	30mm	10.0mm
11mm Finisher	11mm	1.0	30mm	10.0mm
11mm Starter	-	1.25	38mm	9.7mm
11mm Finisher	11mm	1.25	38mm	9.7mm
11mm Starter	-	1.5	38mm	9.5mm
11mm Finisher	11mm	1.5	38mm	9.5mm
12mm Starter	-	0.75	30mm	11.3mm
12mm Finisher	12mm	0.75	30mm	11.3mm
12mm Starter	-	1.0	30mm	11.0mm
12mm Finisher	12mm	1.0	30mm	11.0mm
12mm Starter	-	1.25	38mm	10.7mm
12mm Finisher	12mm	1.25	38mm	10.7mm
12mm Starter	-	1.5	38mm	10.5mm
12mm Finisher	12mm	1.5	38mm	10.5mm
12mm Starter	-	1.75	38mm	10.3mm
12mm Finisher	12mm	1.75	38mm	10.3mm
14mm Starter	-	1.0	30mm	13.0mm
14mm Finisher	14mm	1.0	30mm	13.0mm
14mm Starter	-	1.25	40mm	12.7mm
14mm Finisher	14mm	1.25	40mm	12.7mm
14mm Starter	-	1.5	40mm	12.5mm
14mm Finisher	14mm	1.5	40mm	12.5mm
14mm Starter	-	2.0	40mm	12.0mm
14mm Finisher	14mm	2.0	40mm	12.0mm
16mm Starter	-	1.0	30mm	15.0mm
16mm Finisher	16mm	1.0	30mm	15.0mm
16mm Starter	-	1.5	42mm	14.5mm
16mm Finisher	16mm	1.5	42mm	14.5mm
16mm Starter	-	2.0	42mm	14.0mm
16mm Finisher	16mm	2.0	42mm	14.0mm
18mm Starter	-	1.5	43mm	16.7mm
18mm Finisher	18mm	1.5	43mm	16.7mm
<b>Accessories:</b>				
Bar Type Tap Wrench 3 - 12mm Capacity				
T Type Tap Wrench 6mm Capacity				
1"OD Die Handle				
Screw Pitch Gauge				
Screwdriver				

**TAP & DIE SET 20PC**

12004

Die Diameter $\varnothing$ (mm)		25		
Tap Sizes $\varnothing$ (mm)	Die Sizes (mm)	Pitch (mm)	Length (mm)	Drill Size (mm)
3	3	0.5	18	2.5
4	4	0.7	20	3.3
5	5	0.8	22	4.2
6	6	1	24	5
7	7	1	26	6
8	8	1.25	30	6.8
9	9	1.25	30	7.8
10	10	1.5	32	8
12	12	1.75	36	10.3

Accessories:  
 Bar Type Tap Wrench  
 1" OD Die Holder

Metric set. Covers the basic requirements in each of the above threads and sizes. All taps and dies are made of alloy steel. All dies are solid type. Packaged in a vacuum formed insert in a metal case.



12004

**TAP & DIE SET 39PC**

12006

Die Diameter $\varnothing$ (mm)		25		
Tap Sizes $\varnothing$	Die Sizes	Pitch	Length	Drill Size
<b>Metric Sizes:</b>				
3mm	3mm	0.5mm	18mm	2.5mm
3mm	3mm	0.6mm	18mm	2.5mm
4mm	4mm	0.7mm	20mm	3.3mm
4mm	4mm	0.75mm	20mm	3.3mm
5mm	5mm	0.8mm	22mm	4.2mm
5mm	5mm	0.9mm	22mm	4.2mm
6mm	6mm	1.0mm	24mm	5.0mm
6mm	6mm	0.75mm	24mm	5.3mm
7mm	7mm	0.75mm	26mm	6.3mm
7mm	7mm	1.0mm	26mm	6.0mm
8mm	8mm	1.25mm	30mm	6.8mm
8mm	8mm	1.0mm	30mm	7.0mm
10mm	10mm	1.25mm	32mm	8.8mm
10mm	10mm	1.5mm	32mm	8.5mm
12mm	12mm	1.75mm	38mm	10.3mm
12mm	12mm	1.5mm	38mm	10.6mm

NPT Size:  
 1/8" 1/8" 27 TPI 55mm 8.7mm

Accessories:  
 Bar Type Tap Wrench 3 - 12mm Capacity  
 T Type Tap Wrench 6mm Capacity  
 1" OD Die Handle  
 Screw Pitch Gauge  
 Screwdriver

Metric and NPT set. Covers small to mid range sizes in the above threads and sizes. All taps and dies are made of alloy steel. All dies are solid type. BSP - British Standard Pipe



12006

# 16. Garage & Workshop Equipment



12009

## TAP & DIE SET 60PC

12009



Die Diameter $\varnothing$ (mm)		25			
Tap Sizes $\varnothing$	Die Sizes	Pitch	Length	Drill Size	
<b>Metric Sizes:</b>					
3mm	3mm	0.5mm	18mm	2.5mm	
4mm	4mm	0.7mm	20mm	3.3mm	
5mm	5mm	0.8mm	22mm	4.2mm	
6mm	6mm	1.0mm	24mm	5.0mm	
7mm	7mm	1.0mm	26mm	6.0mm	
8mm	8mm	1.25mm	30mm	6.8mm	
9mm	9mm	1.25mm	30mm	7.8mm	
10mm	10mm	1.5mm	32mm	8.0mm	
10mm	10mm	1.0mm	32mm	9.0mm	
12mm	12mm	1.75mm	36mm	10.3mm	
<b>UNC Sizes:</b>					
#4	#4	40 TPI	16mm	#43	2.3mm
#6	#6	32 TPI	18mm	#36	2.7mm
#8	#8	32 TPI	20mm	#29	3.45mm
#10	#10	24 TPI	22mm	#25	3.8mm
#12	#12	24 TPI	22mm	#16	4.5mm
1/4"	1/4"	20 TPI	24mm	#7	5.1mm
5/16"	5/16"	18 TPI	30mm	17/64"	6.5mm
3/8"	3/8"	16 TPI	35mm	5/16"	7.9mm
7/16"	7/16"	14 TPI	38mm	3/8"	9.4mm
1/2"	1/2"	13 TPI	42mm	27/64"	10.7mm
<b>UNF Sizes:</b>					
#10	#10	32 TPI	22mm	#21	4.0mm
1/4"	1/4"	28 TPI	24mm	#3	5.4mm
5/16"	5/16"	24 TPI	30mm	17/64"	6.9mm
3/8"	3/8"	24 TPI	35mm	21/64"	8.4mm
7/16"	7/16"	20 TPI	38mm	25/64"	9.9mm
1/2"	1/2"	20 TPI	42mm	29/64"	11.5mm
<b>NPT Size:</b>					
1/8"	1/8	27 TPI	55mm	8.7mm	
<b>Accessories:</b>					
Bar Type Tap Wrench 1/2" Capacity					
T Type Tap Wrench 1/4" Capacity					
2 Screw Pitch Gauges					
1" OD Die Handle					
Screwdriver					

Metric, UNC, UNF and NPT set.



WDS13M-WDS25M

## DRILL BIT SETS

WDS13M-WDS25M

Code	Description / Pieces	Steel Type
WDS13M	13PC Drill Bit Set Metric: 1.5, 2, 2.5, 3, 3.2, 3.5, 4, 4.5, 4.8, 5, 5.5, 6 & 6.5mm	HSS-G
WDS19M	19PC Drill Bit Set Metric: 1, 1.5, 2, 2.5, 3, 3.5, 4, 4.5, 5, 5.5, 6, 6.5, 7, 7.5, 8, 8.5, 9, 9.5 & 10mm	HSS-G
WDS25M	25PC Drill Bit Set Metric: 1, 1.5, 2, 2.5, 3, 3.5, 4, 4.5, 5, 5.5, 6, 6.5, 7, 7.5, 8, 8.5, 9, 9.5, 10, 10.5, 11, 11.5, 12, 12.5 & 13mm	HSS-G

High speed steel drill sets in a metal storage case.



**FILE SET 5PC**

A15002

Code	Description
A15002	5 Piece File Set

Set includes 8" round file, 8" half round file, 8" flat (bastard) file, 6" mill file and a 10" mill file. Made of high carbon steel SK-2. Packaged in a canvas wallet.



A15002

**STUD PULLER WRENCH SET 7PC**

10444

Size (mm)	Size (mm)	Size (mm)
5	8	12
6	10	14
7	-	-

Packaged in a blow moulded case. 1/2" drive.



10444

**STUD REMOVER**

10445

Code	Range	Description	Capacity (mm)	Weight (grams)
10445	1/2" Drive	Stud Remover	6 - 19	595

For inserting and removing studs.



10445

**NUT SPLITTER**

08345

Code	Description	Capacity (mm)	Weight (grams)
08345	Heavy Duty Nut Splitter	11 - 20	354

Heavy duty self centring tip.



08345

**THREAD FILES**

08610-08615

Code	Description	Pitches
08610	Metric Pitch Thread File	0.75, 1, 1.25, 1.5, 1.75, 2, 2.5 & 3mm
08611	SAE Pitch Thread File	11, 12, 13, 14, 16, 18, 20 & 24TPI
08612	SAE Pitch Thread File	9, 10, 12, 16, 20, 27, 28 & 32TPI
08614	Metric Pitch Thread File With Chaser	0.8, 1, 1.25, 1.5, 1.75, 2 & 3mm
08615	SAE Pitch Thread File With Chaser	10, 11, 12, 14, 16, 17, 20 & 24TPI

For renewing damaged thread on any diameter bolt, stud, axle or shaft. Files both right and left hand threads.



08610-08615

# 16. Garage & Workshop Equipment



12601

## SCREW EXTRACTOR SET 5PC

12601

Code	Description
12601	5 Piece Screw Extractor Set

No. 1 to No. 5. Spiral flute type. Remove broken studs, bolts etc by drilling pilot hole, insert the screw extractor and turn anti-clockwise.



10440

## SCREW EXTRACTOR SET 5PC

10440

Code	Range	Pieces	Weight (grams)	Length (mm)
10440	No. 1 - 5	5	129	53, 60, 68, 76 & 84

No. 1 to No. 5. Spiral flute type. Remove broken studs, bolts etc by drilling pilot hole, insert the screw extractor and turn anti-clockwise. Drill size stamped on each extractor for easy use.



10441

## SCREW EXTRACTOR SET 5PC

10441

Code	Range	Pieces	Weight (grams)	Length (mm)
10441	No. 1 - 5	5	129	63, 72, 79, 84 & 88

Chrome Molybdenum construction and heat treated. No. 1 to No. 5. Straight flute type. Remove broken studs, bolts etc by drilling pilot hole, drive the screw extractor in and turn anti-clockwise. Drill size stamped on each extractor for easy use.



136573

## MULTI FUNCTION LED HEAD LIGHT

136573

Code	Description	Brightness (lm)	Discharge Time (hours)
136573	3W LED Multi Function Head Light	8	2.5

CREE XRE Bulb. Sensormatic operation button. IR sensors. 100,000 hours LED life. Adjustable head strap. Takes 3 x AAA batteries.



137408

## ALUMINIUM TORCH 1 WATT

137408

Code	Description	Brightness (lm)	Discharge Time (hours)
137408	1W CREE LED Aluminium Torch	55 - 125	4.5

CREE XRE Bulb. Focus control system. Power output: 70lm. Visible distance: 25mm. Takes 3 x AAA batteries.



136878

## RECHARGEABLE MAGNETIC WORK LIGHT

136878

Code	Description	LED Life (hours)	Discharge Time (hours)
136878	27+6 LED Rechargeable Magnetic Work Light	100,000	4.5

Tap mounted hooks swivel 360°. Rechargeable battery. Rubber coated body. Magnetic so ideal to attach to vehicles, tool boxes etc.

# ALL THE SHOW YOU'LL EVER NEED

Our professional KC Tools sales team will be happy to discuss the many display options and ranges we have available with you and plan a layout that suits your store. We have shadow boards and display stands to show off our ranges and make your store look amazeballs.





# 17. Shadow Boards



SHAD01

## SHADOW BOARD

SHAD01

Code	Description	Size
SHAD01	Generic Shadow Board	600 x 900



SHAD4

## 1/2" DR SOCKETS SHADOWBOARD

SHAD4

Code	Description	Size
SHAD4	1/2" Dr Sockets Shadowboard	600 x 900
Code	Description	Capacity
AKC238-AKC262	1/2" Dr Standard Sockets Metric: 8, 9, 10, 11, 12, 13, 14, 15, 16, 17, 18, 19, 20, 21, 22, 23, 24, 25, 26, 27, 28, 29, 30 & 32mm	2 Each
AKC212-AKC230	1/2" Dr Standard Sockets AF: 3/8, 7/16, 1/2, 9/16, 5/8, 11/16, 3/4, 13/16, 7/8, 15/16, 1, 1-1/16, 1-1/8, 1-3/16 & 1-1/4"	2 Each
A13808-A13822	1/2" Dr Deep Sockets Metric: 8, 9, 10, 11, 12, 13, 14, 15, 16, 17, 18, 19, 21 & 22mm	2 Each
A13789-A13807	1/2" Dr Deep Sockets AF: 3/8, 7/16, 1/2, 9/16, 5/8, 11/16, 3/4, 13/16, 7/8 & 15/16"	2 Each
13680-13689	1/2" Dr In-Hex Sockets Metric: 4, 5, 6, 7, 8, 10, 12, 14, 17 & 19mm	2 Each

## 1/2" DR ACCESSORIES SHADOWBOARD

SHAD6



SHAD6

Code	Description	Size
SHAD6	1/2" Dr Socket Accessories Shadowboard	600 x 900
Code	Description	Capacity
AZDA23-AZDA210	1/2" Dr Extension Bars: 75, 125 & 250mm	2 Each
WB32-WB36	1/2" Dr Wobble Extension Bars: 125, 250 & 500mm	2 Each
ZDA16-ZDA20	1/2" Dr Hex Head Extension Bars: 50, 125, 250, 375 & 500mm	2 Each
AZDA10	1/2" Dr Universal Joint	1 Each
ZDA410	250mm 1/2" Dr Sliding T Bar	2 Each
NH13	1/2" Dr 72 Teeth Banjo Ratchet	2 Each
NH9	1/2" Dr 45 Teeth Banjo Ratchet	2 Each
NH11	1/2" Dr Flex Head Banjo Ratchet	2 Each
NH10	1/2" Dr Flex Head Stubby Banjo Ratchet	2 Each
AZDA315	375mm 1/2" Dr Flex Head Handle	3 Each
AKC1238	1/2" Female To 3/8" Male Adaptor	3 Each
KC1234	1/2" Female To 3/4" Male Adaptor	3 Each

**3/4" DR SOCKETS SHADOWBOARD**

SHAD8

Code	Description	Size
SHAD8	3/4" Dr Sockets Shadowboard	600 x 900
Code	Description	Capacity
AKC139-AKC150	3/4" Dr Standard Sockets Metric: 19, 21, 22, 23, 24, 25, 26, 27, 28, 29 & 30mm	2 Each
AKC156-AKC177	3/4" Dr Standard Sockets Metric: 32, 33, 35, 36, 38, 41, 46, 50, 55 & 60mm	1 Each
AKC110-AKC118	3/4" Dr Standard Sockets AF: 3/4, 13/16, 7/8, 15/16, 1, 1-1/16, 1-1/8, 1-3/16 & 1-1/4"	2 Each
AKC119- AKC138	3/4" Dr Standard Sockets AF: 1-5/16, 1-3/8, 1-7/16, 1-1/2, 1-9/16, 1-5/8, 1-11/16, 1-3/4, 1-13/16, 1-7/8, 1-15/16, 2, 2-1/16, 2-1/8, 2-3/16, 2-1/4, 2-5/16, 2-3/8, 2-7/16 & 2-1/2"	1 Each



SHAD8

**3/4" DR ACCESSORIES SHADOWBOARD**

SHAD10

Code	Description	Size
SHAD10	3/4" Dr Socket Accessories Shadowboard	600 x 600
Code	Description	Capacity
KC106	400mm 3/4" Dr Extension Bar	2 Each
KC105	200mm 3/4" Dr Extension Bar	2 Each
KC104	125mm 3/4" Dr Extension Bar	2 Each
KC103	100mm 3/4" Dr Extension Bar	2 Each
KC100	460mm 3/4" Dr Sliding T Bar	2 Each
KC101	475mm 3/4" Dr Flex Head Handle	2 Each
H34	500mm 3/4" Dr Banjo Ratchet	1 Each
KC108	110mm 3/4" Dr Universal Joint	2 Each
KC102	450mm 3/4" Dr L Handle	2 Each



SHAD10

**COMBINATION SPANNER SHADOWBOARD**

SHAD2

Code	Description	Size
SHAD2	Combination Spanners Shadowboard	600 x 900
Code	Description	Capacity
ACM07-ACM24	7, 8, 9, 10, 11, 12, 13, 14, 15, 16, 17, 18, 19, 20, 21, 22, 23 & 24mm	3 Each
AC8-AC32	1/4, 5/16, 3/8, 7/16, 1/2, 9/16, 5/8, 11/16, 3/4, 13/16, 7/8, 15/16 & 1"	3 Each



SHAD2

**RING SPANNER LONG SHADOWBOARD**

SHAD24

Code	Description	Size
SHAD24	Extra Long Ring Spanners Shadowboard	600 x 600
Code	Description	Capacity
A13150-A13156	8x10, 10x12, 12x14, 13x15, 14x17, 16x18, 17x19, 22x24mm	1 Each
A1316-A13166	5/16x3/8, 3/8x7/16, 1/2x9/16, 5/8x11/16, 11/16x3/4, 7/8x15/16"	1 Each



SHAD24

# 17. Shadow Boards



SHAD12

## SHADOWBOARD

SHAD12

Code	Description	Size
SHAD12	1/2" Dr Impact Sockets Shadowboard	600 x 900
Code	Description	Capacity
11338 - 11362	8, 10, 11, 12, 13, 14, 15, 16, 17, 18, 19, 20, 21, 22, 23, 24, 25, 26, 27, 28, 29, 30, 31 & 32mm	1 Each
11370 - 11385	5/16, 3/8, 7/16, 1/2, 9/16, 5/8, 11/16, 3/4, 13/16, 7/8, 15/16, 1, 1-1/16, 1-1/8, 1-3/16 & 1-1/4"	1 Each
11438 - 11462	8, 10, 11, 12, 13, 14, 15, 16, 17, 18, 19, 20, 21, 22, 24, 27, 28, 29, 30 & 32mm	2 Each
11470 - 11485	5/16, 3/8, 7/16, 1/2, 9/16, 5/8, 11/16, 3/4, 13/16, 7/8, 15/16, 1, 1-1/16, 1-1/8, 1-3/16 & 1-1/4"	2 Each



SHAD14

## SHADOWBOARD

SHAD14

Code	Description	Size
SHAD14	Pliers Shadowboard	600 x 900
Code	Description	Capacity
17350 - 27352	150, 180 & 200mm Long Nose Pliers	3 Each
17370 - 17372	150, 180 & 200mm Diagonal Cutting Pliers	3 Each
17360 - 17361	150 & 200mm Long Nose Pliers	3 Each
17390	200mm Bent Nose Pliers	2 Each
17380	250mm Curved Jaw Multi-Grip Pliers	2 Each
17381	300mm Curved Jaw Multi-Grip Pliers	2 Each
17372H	200mm Heavy Duty Diagonal Cutting Pliers	2 Each
17361H	200mm Heavy Duty Longnose Pliers	2 Each
17352H	200mm Heavy Duty Combination Pliers	2 Each
17373	200mm End Cutting Pliers	2 Each
17670	180mm Internal Straight Circlip Pliers	2 Each
17672	180mm Internal Bent Circlip Pliers	2 Each
17671	180mm External Straight Circlip Pliers	2 Each
17673	180mm External Bent Circlip Pliers	2 Each



SHAD18

## SHADOWBOARD

SHAD18

Code	Description	Size (mm)
SHAD18	Adjustable Wrenches Shadowboard	600 x 600
Code	Description	Capacity
A13035 - A13037	150, 200, 250 & 300mm	3 Each
A13020 - A13027	100, 150, 200, 250 & 300mm	3 Each



**SHADOWBOARD**

SHAD16

Code	Description	Size
SHAD16	Anti-Slip Screwdrivers Shadowboard	600 x 900
Code	Description	Capacity
Blade: 16327 - 16321	6.5 x 25, 3 x 75, 3 x 100, 4 x 100, 4 x 100, 5.5 x 125, 6.5 x 150, 8 x 150, 6.5 x 150, 8 x 150, 10 x 200, 5 x 300 & 6 x 300mm	2 Each
Phillips: 16349 - 16352	No.1 x 25, No.2 x 25, No.0 x 60, No.1 x 80, No.2 x 100, No.2 x 100, No.3 x 150, No.3 x 150, No.1 x 200, No.2 x 200, No.1 x 300 & No.2 x 300mm	2 Each



SHAD16

**SHADOWBOARD**

SHAD20

Code	Description	Size (mm)
SHAD20	Industrial, Pin & Centre Punches Shadowboard	600 x 900
Code	Description	Capacity
A7233 - A7235	No.6, No.6, No.10	2 Each
A7201 - A7208	2.5mm, 3mm, 4mm, 5mm, 6mm, 6.5mm, 8mm, 10mm	2 Each
A7211 - A7217	2mm, 2.5mm, 3mm, 4mm, 5mm, 6mm, 6.5mm	2 Each
A7221 - A7255	No.2, No.2.5, No.3, No.4, No.5	2 Each



SHAD20

**SHADOWBOARD**

SHAD22

Code	Description	Size (mm)
SHAD22	Starter Drift Punches & Chisels Shadowboard	600 x 600
Code	Description	Capacity
A7241 - A7246	2mm, 3mm, 5mm, 6.5mm, 8mm, 10mm	2 Each
A7251 - A7256	10mm, 12mm, 16mm, 19mm, 22mm, 25mm	2 Each



SHAD22

## YOUR COMPLETE TOOL SOLUTION





Established in 1979, AOK is a company concentrating on the Professional Automotive and Industrial markets with its headquarters in Taiwan. AOK is proud to be a global supplier of top quality innovative 'Made-In-Taiwan' professional tools.

AOK has many satisfied customers all over the world including the USA, Canada, Europe, Mexico, Middle East, India, China and Australia. Having accumulated decades of OEM experience, AOK has developed itself a strong and respected private brand.

AOK prides itself on working closely with its industry leading customers and innovative suppliers. AOK applies professional users' feedback to the development of new and better products that provide their customers with uniqueness in their market.

With the belief in quality, customer orientated Research & Development and complete customized solutions, AOK applies not only a broad and innovative product line to support its industry leading customers but also builds strategic partnership with them to add value to products and services that exceed customers expectations.

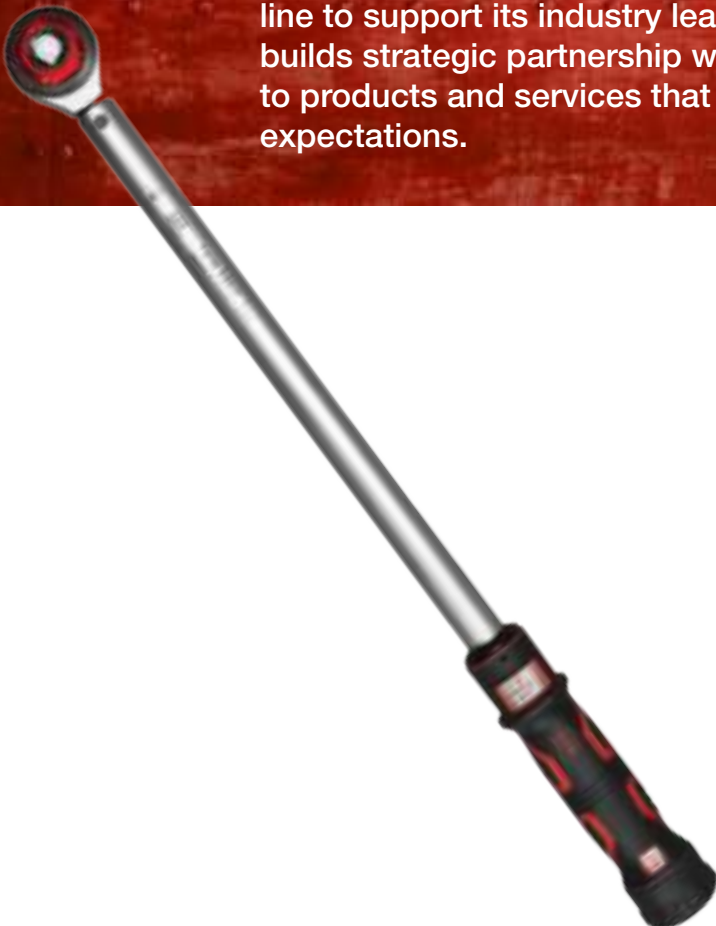



# 18. A.O.K

**TWW** **TORQUE** **4 TIMES ACCURACY LIFE**

## Adjustable Window Torque Wrenches

AOK Item No.	KC Equivalent	Square Driver	Range	Length (mm)
TWW60N	H48	3/8"	10 - 60 Nm	427
TWW100N	H49	3/8"	20 - 200 Nm	462
TWW200N	H50	1/2"	40 - 200 Nm	517
TWW320N	H51	1/2"	60 - 320 Nm	586



Side-to-side compact ratchet head provides both 60 and 120 teeth options



AOK Item No.	KC Equivalent	Square Driver	Range	Length (mm)
TWW15N	-	1/4"	3 - 15 Nm	193
TWW30	H47	1/4"	6 - 30 Nm	300

AOK Item No.	KC Equivalent	Square Driver	Range	Length (mm)
TWW500N-3	H52	3/4"	100 - 500 Nm	820
TWW800N-3	-	3/4"	100 - 800 Nm	1111
TWW1000N-3	H53	3/4"	200 - 1000 Nm	1335
TWW10000N8-3	H54	1"	200 - 1000 Nm	1335
TWW15000N8-3	H55	1"	300 - 1500 Nm	1702
TWW2000N-3	-	1"	400 - 2000 Nm	2150



- Each wrench is calibrated to +/- 4% accuracy tolerance according to DIN ISO 6789:2003
- Each wrench is laser-etched the torque setting range, precision direction and a traceable serial number
- Chromed matt finish gives high corrosion protection
- The wrench actuates with a tactile impulse and audible signal when the pre-set torque is reached
- For all wrenches with maximal setting range bigger than 500Nm, there are three units including Nm, ft.lb and kg.m
- Works on both clockwise and counter clockwise
- 4 Times the accuracy life of TWG and TWO ranges, ideal for high frequency users

# Adjustable Torque Wrenches

- Each wrench is calibrated to +/- 4% accuracy tolerance according to DIN EN 6789:2003
- Each wrench is laser-etched the torque setting range, precision direction and a traceable serial number
- The wrench actuates with a tactile impulse and audible signal when the pre-set torque is reached
- Only works on clockwise direction

AOK Item No.	KC Equivalent	Square Driver	Range	Length (mm)
TWO210N	-	1/2"	42 - 210 Nm	470
TWO350N	-	1/2"	70 - 350 Nm	633

## Adjustable Torque Wrenches

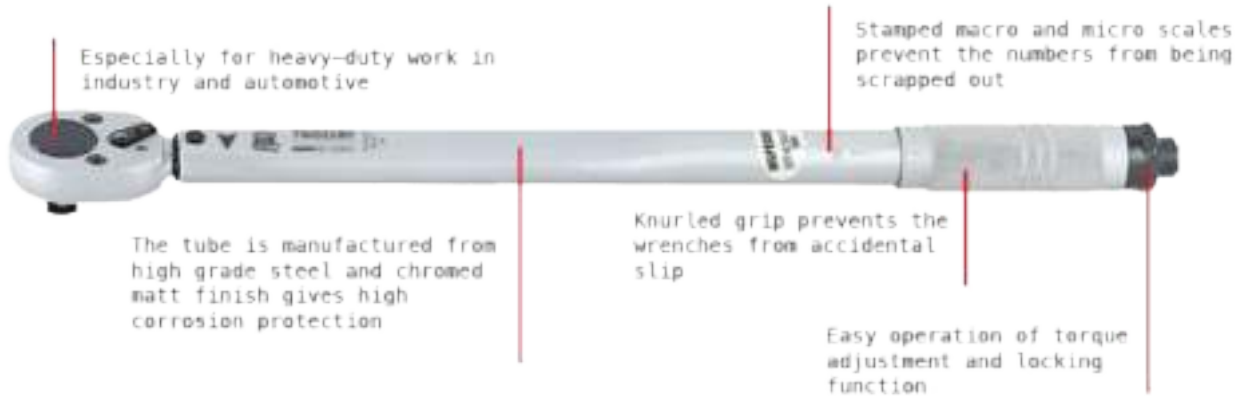

18.A.0.K

### TIW100N-12K

TIW100N-12K (KC - H60)

1pc TIW100N torque wrench: 20 - 100 Nm

10pc 9x12mm open ended inserts: 10, 11, 12, 14, 15, 16, 17, 18, 19mm

1pc 9x12mm 3/8" drive ratchet head



### TIW200N-11K

TIW200N-11K (KC - H70)

1pc TIW200N torque wrench: 40 - 200 Nm

10pc 14x18mm open ended inserts: 13, 14, 15, 17, 19, 22, 24, 27, 30mm

1pc 14x18mm 1/2" drive ratchet head



# 18. A.O.K

**TWR**



4 TIMES ACCURACY LIFE

## Adjustable Torque Wrenches

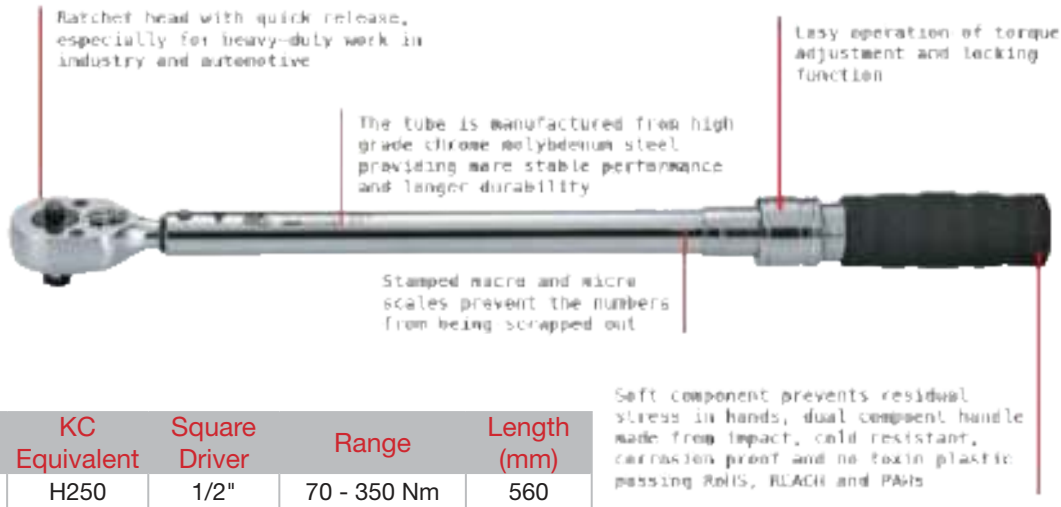

AOK Item No.	KC Equivalent	Square Driver	Range	Length (mm)
TWR350N	H250	1/2"	70 - 350 Nm	560

- Each wrench is calibrated to +/- 4% accuracy tolerance according to DIN ISO 6789:2003
- Each wrench is laser-etched the torque setting range, percision direction and a traceable serial number
- Chromed matt finish gives high corrosion protection
- The wrench actuates with a tactile impulse and audible signal when the pre-set torque is reached
- For all wrenches with maximal setting range bigger than 500Nm, there are three units including Nm, ft.lb and kg.m
- Works on both clockwise and counter clockwise
- 4 Times the accuracy life of TWG and TWO ranges, ideal for high frequency users

**TWG**



## Adjustable Torque Wrenches

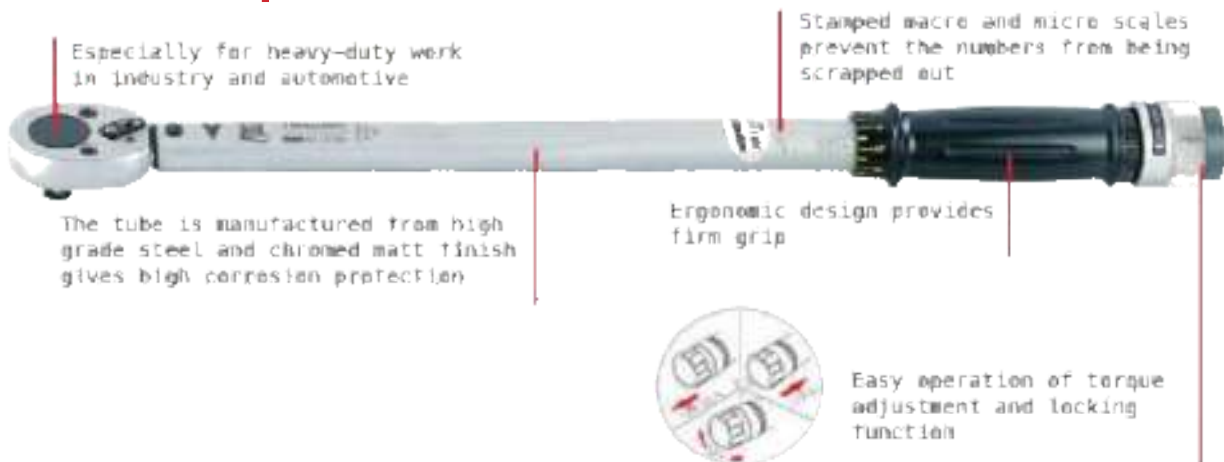

AOK Item No.	KC Equivalent	Square Driver	Range	Length (mm)
TWG110N	H49	3/8"	20 - 110 Nm	385
TWG210N	H50	1/2"	40 - 210 Nm	535
TWG350	H51	1/2"	70 - 350 Nm	645

- Each wrench is calibrated to +/- 4% accuracy tolerance according to DIN ISO 6789:2003
- Each wrench is laser-etched the torque setting range, percision direction and a traceable serial number
- Chromed matt finish gives high corrosion protection
- The wrench actuates with a tactile impulse and audible signal when the pre-set torque is reached
- Works on clockwise direction



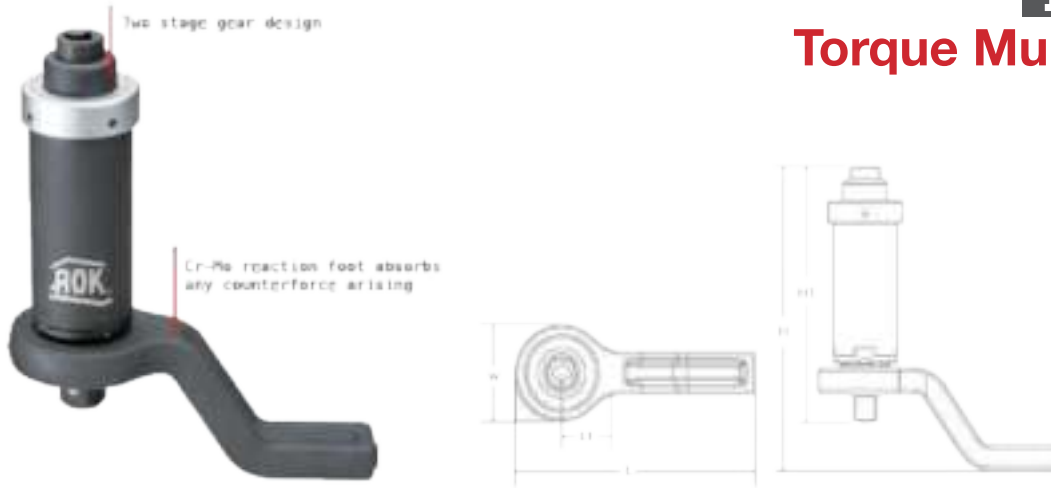

TM10-400N	
Input Range (Max)	400 Nm / 290 ft.lb
Output Range (Max)	4000 / 2900 ft.lb
Ratio	1 : 10
Input Square	1/2"
Output Square	1"
W (mm)	108
H (mm)	254
H1 (mm)	228
L (mm)	263
L1 (mm)	50

- Each wrench is calibrated to +/- 6% accuracy tolerance of the transmission ratio 1 : 10
- The whole torque multiplier is made from high grade chrome-molybdenum providing longer durability and higher torque capacity
- Each multiplier is laser-etched the torque setting range, precision direction and a traceable serial number
- Torque multiplier with maximal output torque higher than or equal to 4000 Nm has the reactionless ratchet mechanism which provides safety during operation

**Adjustable Angular Digital Torque Wrenches**



Adjustable Angular Digital Torque Wrenches		
Item No.	DTWA-135N	DTWA4-340N
Torque Accuracy	CW: ± 2%, CWW: ± 3%	
Angle Accuracy	± 2% rotating 90° at speed of 30°	
Torque & Angle Measure Range	6.8~135 Nm / 0°~360°	17~340 Nm / 0°~360°
Pre-Setting No.	9 Sets	
Operation Mode	Peak hold / Track	
Unit Selection	N-m, in-lb, ft-lb, kg-cm, Angle	
Square Drive	3/8"	1/2"
Gear Teeth	36	
Data Memory Size	50	
Communication	No	
Operating Temperature	-10°C ~ 60°C	
Storage Temperature	-20°C ~ 70°C	
Humidity	up to 90% non-condensing	



# 18. A.O.K

## THPR

For TWW, TWR and TWRP Type



AOK Item No.	Driver	Teeth	Suitable For
THPR110	3/8"	32	TWR110N
THPR210	1/2"	32	TWR210N
THPR350	1/2"	32	TWR350N
THPR450	3/4"	32	TWW500N-3
THPR800	3/4"	32	TWW800N-3
THPR1500	3/4"	32	TWW1000N-3
THPR1501	1"	32	TWW1000N8-3 & TWW1500N8-3

## THPG

For TWO, TWG Type



AOK Item No.	Driver	Teeth	Suitable For
THPR60S	3/8"	24	TWO25N
THPG80	3/8"	24	TWO100N & TWG110N
THPG150	1/2"	24	TWO210N & TWG210N
THPG250	1/2"	24	TWO350N & TWG350N

## THPW

For TWW Type



AOK Item No.	Driver	Teeth	Suitable For
THPW30	1/4"	43	TWW5N, TWW15N & TWW30N
THPW30A	3/8"	43	TWW30N3

## THPWS

For TWW Type



AOK Item No.	Driver	Teeth	Suitable For
THPWS603	3/8"	60 & 120	TWW60N & TWW100N
THPWS604	1/2"	60 & 120	TWW200N & TWW320N

**DSK2-09I**

**1/4" DR Deep Socket Set 9pc**

CONTENTS
9pc Deep Sockets:
3/16", 7/32", 1/4", 9/32", 5/16" 11/32", 3/8", 7/16", 1/2"



**DSK2-12**

**1/4" DR Deep Socket Set 12pc**

CONTENTS
12pc Deep Sockets:
4, 4.5, 5, 5.5, 6, 7, 8, 9, 10, 11, 12, 13



**SDHK2-11I**

**1/4" DR Double Hex Socket Set 11pc**

CONTENTS
11pc Double Hex Sockets:
5/32", 3/16", 7/32", 1/4", 9/32", 5/16" 11/32", 3/8", 7/16", 1/2", 9/16"



**BSK2-07**

**1/4" DR Metric In-Hex Socket Set 7pc**

CONTENTS
7pc In-Hex Sockets:
H3, H4, H5, H6, H7, H8, H10



**DSK3-08**

**3/8" DR Deep Socket Set 8pc**

CONTENTS
8pc Deep Sockets:
8, 10, 12, 13, 14, 16, 17, 19





# 18. A.O.K

## SDHK3-12

### 3/8" DR Metric Double Hex Socket Set 12pc



#### CONTENTS

12pc Double Hex Sockets:

8, 9, 10, 11, 12, 13, 14, 15,  
16, 17, 18, 19

## SDDK3-12

### 3/8" DR Metric Double Hex Deep Socket Set 12pc



#### CONTENTS

12pc Double Hex Deep Sockets:

8, 9, 10, 11, 12, 13, 14, 15,  
16, 17, 18, 19

## SDDK3-10I

### 3/8" DR Imperial Double Hex Deep Socket Set 10pc



#### CONTENTS

10pc Double Hex Deep Sockets:

5/16", 3/8", 7/16", 1/2", 9/16", 5/8",  
11/16", 3/4", 13/16", 7/8"

## SSK3-08E

### 3/8" DR Star Socket Set 8pc



#### CONTENTS

8pc Star Sockets:

E6, E7, E8, E10, E11, E12, E14, E16

**BSK3-07**

**3/8" DR Metric In-Hex Bit Socket Set 7pc**

**CONTENTS**

7pc In-Hex Sockets:

3, 4, 5, 6, 7, 8, 10



**BSK3-07I**

**3/8" DR Imperial In-Hex Bit Socket Set 7pc**

**CONTENTS**

7pc In-Hex Sockets:

1/8", 5/32", 3/16", 7/32", 1/4"  
5/16", 3/8"



**BSK3-11TT**

**3/8" DR Tamperproof Bit Socket Set 11pc**

**CONTENTS**

11pc Tamperproof Sockets:

T10, T15, T20, T25, T27, T30, T40  
T45, T50, T55, T60



# 18. A.O.K

## SSK4-37

### 1/2" DR Socket Set 37pc



#### CONTENTS

##### 20pc Hex Sockets:

10, 11, 12, 13, 14, 15, 16, 17, 18, 19  
20, 21, 22, 23, 24, 26, 27, 28, 30, 32

6pc Deep Hex Sockets: 13, 14, 15, 16, 22, 24

3pc Thin Wall Deep Sockets: 17, 19, 21

2pc Extension Bar: 125, 250

2pc Spark Plug Socket: 16, 21

1pc Ratchet Handle

1pc Sliding T Bar

1pc Universal Joint

1pc Swivel Handle: 15" (375mm)

## SDHK4-12

### 1/2" DR Double Hex Socket Set 12pc



#### CONTENTS

##### 12pc Double Hex Sockets:

10, 11, 12, 13, 14, 15, 16, 17, 19  
21, 22, 24

## SDDK4-12

### 1/2" DR Double Hex Deep Socket Set 12pc



#### CONTENTS

##### 12pc Double Hex Deep Sockets:

10, 11, 12, 13, 14, 15, 16, 17, 19  
21, 22, 24



**SSK4-09E**

**1/2" DR Star Socket Set 9pc**



**CONTENTS**

9pc Star Sockets:

E10, E11, E12, E14, E16, E20, E22, E24

**BSK4-16T**

**3/8" DR Star Socket Set 9pc**



**CONTENTS**

7pc In-Star Bit Sockets:

T30, T40, T45, T50, T55, T60, T70

9pc Star Sockets:

E10, E11, E12, E14, E16, E18,  
E20, E22, E24

# 18. A.O.K

## IIK46-08M

### 1/2" & 3/4" DR In-Spline Impact Socket Set 8pc



#### CONTENTS

Length 45mm: M14, M16, M18

Length 77mm: M14, M16, M18

4mm Hex Key

3/4" DR 22mm Hex Impact Holder

## IIK46-18T

### 1/2" & 3/4" DR In-Star Impact Socket Set 8pc



#### CONTENTS

Length 45mm: T80, T90, T100

Length 77mm: T80, T90, T100

4mm Hex Key

3/4" DR 22mm Hex Impact Holder

# SHH234-46

## PLASTIC SOCKET TRAY METRIC SET 3pc



### CONTENTS

1/4" Socket Holder - 4, 4.5, 5, 5.5, 6, 7, 8, 9, 10, 11, 12, 13, 14, 15mm

3/8" Socket Holder - 6, 7, 8, 9, 10, 11, 12, 13, 14, 15, 16, 17, 18, 19, 20mm

1/2" Socket Holder - 10, 11, 12, 13, 14, 15, 16, 17, 18, 19, 20, 21, 22, 23, 24, 25, 27mm

\*\*Fits Standard and Deep Sockets

# SHH234-46I

## PLASTIC SOCKET TRAY IMPERIAL SET 3pc



### CONTENTS

1/4" Socket Holder - 1/8, 5/32, 3/16, 7/32, 1/4, 9/32, 5/16, 11/32, 3/8, 7/16, 1/2, 9/16, 5/8"

3/8" Socket Holder - 1/4, 5/16, 3/8, 7/16, 1/2, 9/16, 5/8, 11/16, 3/4, 13/16, 7/8, 15/16, 1"

1/2" Socket Holder - 3/8, 7/16, 1/2, 9/16, 5/8, 11/16, 3/4, 13/16, 7/8, 15/16, 1, 1-1/16, 1-1/8, 1-1/4"

\*\*Fits Standard and Deep Sockets

# TBK-55175

## 1/2" DR Torsion Bar Kit 7pc



### CONTENTS

Part No.	Ft-Lbs	Length
TRB55F	55	200
TRB65F	65	200
TRB80F	80	200
TRB100F	100	200
TRB120F	120	200
TRB140F	140	200
TRB175F	175	200



# 18. A.O.K

## AIW-10306X

### 3/8" DR Side-to-Side Composite Impact Wrench



#### AIW-10306X

Net Weight: 1.24Kg
Mechanism: Twin Hammer
Square Drive: 3/8"
Free Speed: 13,500 RPM
Working Torque: 400 ft-lb / 542Nm (in 5 seconds)
Maximum Torque: 580 ft-lb / 786Nm
Average Air Consumption: 5.9CFM @90PSI
Material: Aluminium Alloy + Composite handle

## AIW-10406X

### 1/2" DR Side-to-Side Composite Impact Wrench



#### AIW-10406X

Net Weight: 1.24Kg
Mechanism: Twin Hammer
Square Drive: 1/2"
Free Speed: 13,500 RPM
Working Torque: 430 ft-lb / 583Nm (in 5 seconds)
Maximum Torque: 580 ft-lb / 786Nm
Average Air Consumption: 5.9CFM @90PSI
Material: Aluminium Alloy + Composite handle

# AIW-10410X

## 1/2" DR Side-to-Side Composite Impact Wrench

### AIW-10410X

Net Weight: 1.88Kg
Mechanism: Twin Hammer
Square Drive: 1/2"
Free Speed: 8,500 RPM
Working Torque: 750 ft-lb / 1017Nm (in 5 seconds)
Maximum Torque: 1100 ft-lb / 1491Nm
Average Air Consumption: 6.9CFM @90PSI
Material: Aluminium Alloy + Composite handle



18.A.O.K



# AIW-10410MT

## 1/2" DR Side-to-Side Composite Impact Wrench

### AIW-10410MT

Net Weight: 1.88Kg
Mechanism: Twin Hammer
Square Drive: 1/2"
Free Speed: 5,500 RPM
Working Torque: 80 ft-lb / 108Nm (in 5 seconds)
Maximum Torque: 880 ft-lb / 1085Nm
Average Air Consumption: 6.7CFM @90PSI
Material: Aluminium Alloy + Composite handle
**Forward torque is limited by 80 ft-lb



# 18. A.O.K

## AIW-00404

### 1/2" DR Air Impact Wrench



AIW-00404

Net Weight: 2.6Kg

Mechanism: Twin Hammer

Square Drive: 1/2"

Free Speed: 8,000 RPM

Working Torque: 450 ft-lb / 610Nm (in 5 seconds)

Maximum Torque: 500 ft-lb / 678Nm

Average Air Consumption: 35CFM @90PSI (4.9CFM)

Material: Aluminium Alloy

- **Twin hammer mechanism provides strong and stable torque**
- **The strengthened structure offers amazing durability**





## AIR-3407

### 1/2" DR Air Ratchet

#### AIR-3407

Net Weight: 1.2Kg
Square Drive: 1/2"
Free Speed: 160 RPM
Maximum Torque: 51 ft-lb / 70Nm
Air Inlet: 1/4"
Overall Length: 230mm
Average Air Consumption: 7.1CFM
Clutch Mechanism: Triple Gear
Exhaust System: Rear
Suggested Air Pressure: 90PSI

- Composite body reduces weight and provides better grip
- Strengthened gears provide longer durability
- Reduces Vibrations
- Continuous Regulation



## ADG-2322

### 1/2HP High Speed Air Die Grinder

#### ADG-2322

Net Weight: 0.6KG
Collect Size: 1/8" - 1/4" (3-6mm)
Free Speed: 22,000 RPM
Air Inlet: 1/4"
Overall Length: 175mm
Average Air Consumption: 12.3CFM
Exhaust System: Rear
Suggested Air Pressure: 90PSI

- Composite body reduces weight and provides better grip
- Safety lever to prevent accidental start-up
- Reduces Vibrations
- Continuous Regulation



## ADG-2322A

### 1/2 High Speed Angle Die Grinder

#### ADG-2322A

Net Weight: 0.6KG
Collect Size: 1/8" - 1/4" (3-6mm)
Free Speed: 18,000 RPM
Air Inlet: 1/4"
Overall Length: 175mm
Average Air Consumption: 12.3CFM
Exhaust System: Rear
Suggested Air Pressure: 90PSI

- Composite body reduces weight and provides better grip
- Safety lever to prevent accidental start-up
- Reduces Vibrations
- Continuous Regulation



# 18. A.O.K

## ADI-3219A

### 1/2 HP Low Speed Angle Air Drill



#### ADI-3219A

Net Weight: 0.96KG
Chuck Size: 10mm (3/8")
Free Speed: 1,900 RPM
Air Inlet: 1/4"
Length x Height: 190 x 110mm
Average Air Consumption: 10CFM
Exhaust System: Rear
Suggested Air Pressure: 90PSI

- Ideal for abrasive job requiring low speed
- Compact angle head allows users to access in confined spaces
- Composite body reduces weight and provides better grip
- Safety lever to prevent accidental start-up

## ACO-3320

### Air Cut-off Tool



#### ACO-3320

Net Weight: 0.8KG
Disk Size: 3"
Free Speed: 20,000 RPM
Air Inlet: 1/4"
Overall Height: 190mm
Average Air Consumption: 12.3CFM
Exhaust System: Rear
Suggested Air Pressure: 90PSI

- Ideal for cutting through composite, sheet metal, etc.
- Composite body reduces weight and provides better grip
- Safety lever to prevent accidental start-up
- Strengthened gears provide longer durability

## ATB-1240

### Low Speed Tyre Buffer



#### ATB-1240

Net Weight: 0.8KG
Quick Change: Hex 11.11
Free Speed: 4,000 RPM
Air Inlet: 1/4"
Overall Length: 225mm
Average Air Consumption: 11CFM
Exhaust System: Rear
Suggested Air Pressure: 90PSI

- Ideal for abrasive job requiring low speed such as tyre buffing
- Quick and fast change of buffing wheels or carbide cutters
- Safety lever to prevent accidental start-up

## AHM-1050

### Short Barrel Air Hammer

#### AHM-1050

Net Weight: 1.2KG
Round Shank Diameter: 10mm
Piston Diameter: 35mm
Piston Stroke: 19mm
Blow Frequency: 5000BPM
Overall Length: 133mm
Average Air Consumption: 10CFM
Air Inlet: 1/4" NPT
Hose Inner Diameter: 10mm
Suggested Input Pressure: 90PSI

- Ideal for tire service
- Stubby handle reduces the weight and allows the use in confined spaces



18.A.0.K





# 18. A.O.K

## AHM-93210

### Pneumatic Bits and Chisels

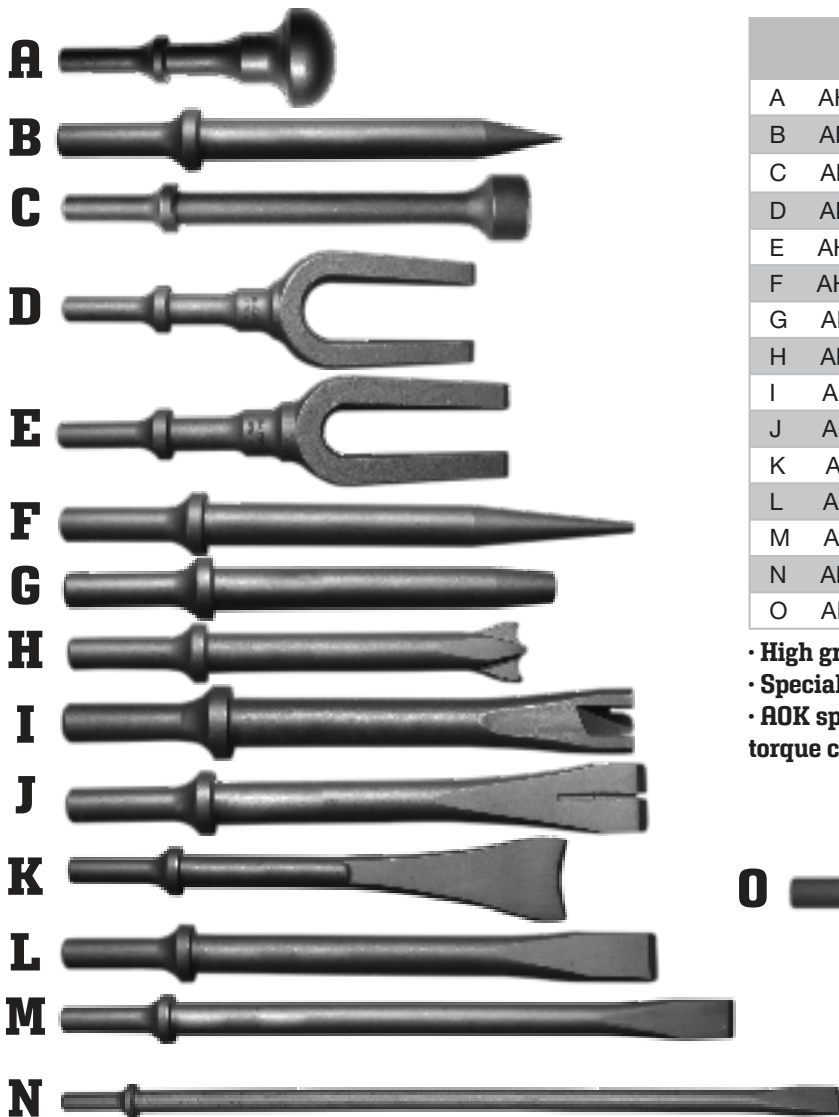

#### AHM-93210

A	AHM-932101	Round head 110mm
B	AHM-932102	Taper punch sharp point 165mm
C	AHM-932103	Long Hammer 112mm
D	AHM-932104	Tie rod separator 178mm
E	AHM-932105	Ball joint separator 178mm
F	AHM-932106	1/8" taper punch 178mm
G	AHM-932107	9.5mm taper punch 152mm
H	AHM-932108	Double cut body ripper 152mm
I	AHM-932109	Sheet metal trimmer 152mm
J	AHM-932110	Rivet and bolt cutter 178mm
K	AHM-932111	Tail pipe cut-off 190mm
L	AHM932112	Cold Chisel 165mm
M	AHM-932113	Cold Chisel 267mm
N	AHM-932114	Cold Chisel 457mm
O	AHM-932115	Scraper with 34mm, 180mm Lenght

- High grade chrome vanadium steel
- Specially designed for air hammer
- AOK special heat treatment techniques ensure higher torque capacity and longer durability



## AHMK-4

### 4pc 10mm Round Shank Pneumatic Bit Set



#### Contents

1pc	178mm long hammer
1pc	152mm slotted panel cutter
1pc	165mm cold chisel
1pc	178 scraper with 35mm tip

**Breaking Torque Test**

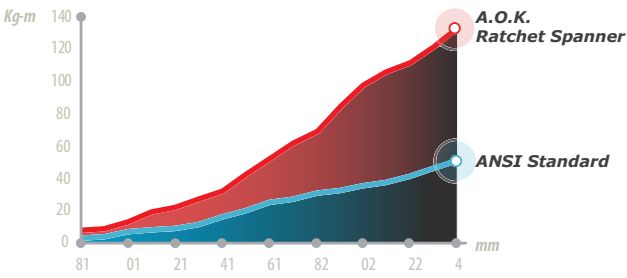

**New 72 teeth ratchet technology provides more contact area, therefore, higher torque performance**

**Hard stamped arrows indicate the direction to apply torque**

**Use environmentally friendly plating technology meeting RoHS standards**

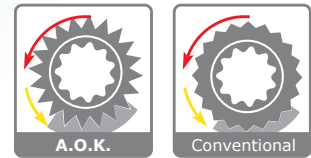

**15 degree open end angle**

**Better contact**



- Uniform distribution of the force on the screw head flanks. Prevent the corners of screw head from being stripped off
- More contact area results in less residual stress

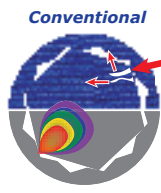

- Sharp point contact breaks the screw head easily
- High residual stress strips off the corners of the screw head. The rounded screw head might cause dangerous slipping while operation and cannot be unscrewed

# 18. A.O.K

## RS

### Ratchet Combination Wrenches



#### Metric

A.O.K Item No.	Size	Length
RS-08	8	150
RS-09	9	165
RS-10	10	180
RS-11	11	195
RS-12	12	207
RS-13	13	220
RS-14	14	135
RS-15	15	250
RS-16	16	260
RS-17	17	275
RS-18	18	290
RS-19	19	305
RS-21	21	330
RS-22	22	330
RS-24	24	355

- High grade chrome vanadium steel
- AOK special heat treatment techniques ensure higher torque capacity and longer durability
- 15° open end angle
- Hard stamped arrows indicate the direction to apply torque
- Use environmentally friendly plating technology meeting RoHS standards
- Exceed DIN 899 and proof torque in ANSI/ASME B107.6

#### AF

A.O.K Item No.	Size	Length
RS-05I	5/46"	136
RS-06I	3/8"	160
RS-7I	7/16"	168
RS-8I	1/2"	180
RS-9I	9/16"	193
RS-10I	5/8"	216
RS-11I	11/16"	233
RS-12I	3/4"	250

## RSS

### Stubby Ratchet Combination Wrenches



#### Metric

A.O.K Item No.	Size	Length
RSS-08	8	88
RSS-09	9	96
RSS-10	10	96
RSS-11	11	100
RSS-12	12	104
RSS-13	13	108
RSS-14	14	114
RSS-15	15	118
RSS-16	16	122
RSS-17	17	128
RSS-18	18	132
RSS-19	19	138

- High grade chrome vanadium steel
- AOK special heat treatment techniques ensure higher torque capacity and longer durability
- 15° open end angle
- Extra short body allows the use in confined space
- Hard stamped arrows indicate the direction to apply torque
- Use environmentally friendly plating technology meeting RoHS standards
- Exceed DIN 899 and proof torque in ANSI/ASME B107.6



**Extra Long Double Box Ratchet Wrenches**



**Metric**

- High grade chrome vanadium steel
- AOK special heat treatment techniques ensure higher torque capacity and longer durability
- 15° open end angle
- Extra long body and fix box end allows users to apply strong torque
- Laser-etched arrows indicate the direction to apply torque
- Use environmentally friendly plating technology meeting RoHS standards
- Exceed DIN 899

**Function Introduction**

Flat offset box end & one side without chamfer



Box end without chamfer fits all types of corrupted nuts

A.O.K Item No.	Size	Length
RSLD-08	8	222
RSLD-09	9	227
RSLD-10	10	242
RSLD-11	11	252
RSLD-12	12	268
RSLD-13	13	286
RSLD-14	14	306
RSLD-15	15	324
RSLD-16	16	349
RSLD-17	17	374
RSLD-18	18	385
RSLD-19	19	397

18.A.O.K

**Reversible Ratchet Wrenches**



**Metric**

- High grade chrome vanadium steel
- AOK special heat treatment techniques ensure higher torque capacity and longer durability
- 15° open end angle
- 15° box end offset from shaft
- Laser-etched arrows indicate the direction to apply torque
- Use environmentally friendly plating technology meeting RoHS standards
- Exceed DIN 899 and proof torque in ANSI/ASME B107.6

A.O.K Item No.	Size	Length
RSR-08	8	135
RSR-09	9	142
RSR-10	10	158
RSR-11	11	167
RSR-12	12	173
RSR-13	13	179
RSR-14	14	189
RSR-15	15	199
RSR-16	16	215
RSR-17	17	232
RSR-18	18	238
RSR-19	19	247

# 18. A.O.K

## RSK-8

### Ratchet Wrench Metric Set 8pc



#### CONTENTS

8, 10, 11, 12, 13, 14, 17, 19mm

## RSK-8I

### Ratchet Wrench AF Set 8pc



#### CONTENTS

5/16", 3/8", 7/16", 1/2", 9/16", 5/8", 11/16", 3/4"

## RSK-12

### Ratchet Wrench Metric Set 12pc



#### CONTENTS

8, 9, 10, 11, 12, 13, 14, 15, 16, 17, 18, 19mm

## RSRK-12

### Reversible Ratchet Wrench Metric Set 12pc

#### CONTENTS

8, 9, 10, 11, 12, 13, 14, 15, 16, 17, 18, 19mm



18.A.O.K

## RSLDK-8

### Extra Long Double Box End Ratchet Wrench Set 8pc

#### Metric

#### CONTENTS (RSLDK-8)

8, 10, 11, 12, 13, 14, 17, 19mm

#### AF

#### CONTENTS (RSLDK-8I)

5/16", 3/8", 7/16", 1/2", 9/16", 5/8", 11/16", 3/4"



## RSL

### Extra Long Ring Spanner



#### Metric

- High grade chrome vanadium steel
- AOK special heat treatment techniques ensure higher torque capacity and longer durability
- Metric spanners: satin finish, DIN899-A

A.O.K Item No.	Size	Length
RSL-0810	8 x 10	235
RSL-1012	10 x 12	290
RSL-1214	12 x 14	328
RSL-1315	13 x 15	368
RSL-1417	14 x 17	388
RSL-1618	16 x 18	388
RSL-1719	17 x 19	408
RSL-2224	22 x 24	430



# 18. A.O.K

## RSLK4

### Long Ring Spanner Set 4pc



#### CONTENTS

8 x 10, 12 x 14, 17 x 19, 22 x 24



**DRS****Double End Socket Ratchet Wrenches**

- High grade chrome vanadium steel
- AOK special heat treatment techniques ensure higher torque capacity and longer durability
- Go-trough design can take long screw bolts
- Similar to DIN896, Form A, ISO 2236, ISO 1085

A.O.K Item No.	Size	Lenght	Torque (kgf-m)
DRS1113	11 x 13	240	8-9
DRS1417	14 x 17	280	14-16
DRS1719	17 x 19	315	52-60
DRS1721	17 x 21	315	52-60
DRS1921	19 x 21	315	52-60
DRS1922	19 x 22	315	52-60
DRS1824	18 x 24	315	52-60
DRS2427	24 x 27	360	73-80
DRS2430	24 x 30	450	160-170
DRS2730	27 x 30	450	160-170
DRS2632	26 x 32	450	160-170
DRS2732	27 x 32	450	160-170

**18.A.O.K****HOS****Open End Slogging Spanners**

- Chrome Molybdenum alloy steel
- AOK special heat treatment techniques ensure higher torque capacity and longer durability
- Suitable for all kinds of heavy duty work
- For use with a sledge hammer

**Metric**

A.O.K Item No.	Size	Lenght
HOS32	32	200
HOS35	35	200
HOS36	36	200
HOS38	38	230
HOS41	41	230
HOS46	46	270
HOS50	50	270

# 18. A.O.K

## VG CJ

### Curved Jaw Locking Pliers With Wire Cutter



A.O.K Item No.	KC Equivalent	Size	Jaw Capacity
VG CJ05	17018	5" (140mm)	29mm
VG CJ10	17024	10" (250mm)	48mm

- High grade chrome-molybdenum steel
- AOK special heat treatment techniques
- With wire cutter, adjustment screw and release lever
- Special spring provides steady pressure to ensure the firm clamp
- Forged curved jaw for round material

## VGLN

### Long Nose Locking Pliers



A.O.K Item No.	KC Equivalent	Size	Jaw Capacity
VGLN06	17027	6" (160mm)	51mm
VGLN09	17026	9" (230mm)	70mm

- High grade chrome-molybdenum steel
- AOK special heat treatment techniques
- With wire cutter, adjustment screw and release lever
- Special spring provides steady pressure to ensure the firm clamp
- Forged long narrow jaws allow the use in confined space
- Ideal for clamping, tightening, twisting and turning

## VGWC

### Welding Clamp



A.O.K Item No.	KC Equivalent	Size	Jaw Capacity
VGWC09	17046	9" (230mm)	43mm

- High grade chrome-molybdenum steel
- AOK special heat treatment techniques
- Special spring provides steady pressure to ensure the firm clamp
- Ideal for clamping strips and profile sections when welding
- U-shaped jaws provide more visibility and work space

**VGCL**

**C-Clamp Locking Pliers**

A.O.K Item No.	KC Equivalent	Size	Jaw Capacity
VGCL11	17036	11" (280mm)	100mm

- High grade chrome-molybdenum steel
- AOK special heat treatment techniques
- Special spring provides steady pressure to ensure the firm clamp
- Ideal for clamping strips and profile sections when welding
- C-shaped wide jaws provide more visibility and work space



**HMBP**

**Ball Pein Hammer**



- Head is made from drop forged fine grain carbon steel
- AOK special heat treatment techniques
- The tapered collar bonds the head to the handle into one unit
- ASME B107.400
- ISO 15601

A.O.K Item No.	KC Equivalent	Length	Head Weight
HMBP300	14090	300	8oz / 226g
HMBP301	14091	300	12oz / 340g
HMBP350	14092	350	16oz / 453g
HMBP400	14093	400	24oz / 680g
HMBP401	14094	400	32oz / 907g
HMBP410	14095	410	48oz / 1360g

**VI-06207**

**Spring Compressor**

- Capacity: 300MM long

**HEAVY DUTY COIL SPRING CLAMP**  
Easily removes and installs automotive coil springs with solid alloy steel hooks and 5/8" acme rod and nuts for secure safe operation

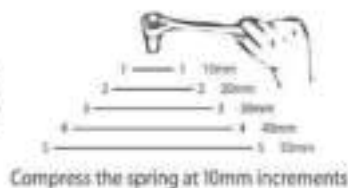
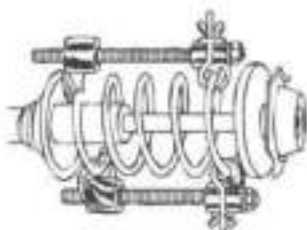

(KC No. 10409)



# 18. A.O.K

## PUG02

### 2 Jaw Gear Puller



A.O.K Item No.	KC Equivalent	Size	Range (mm)
PUG0203	10770	3"	40-76
PUG0204	10772	4"	50-102
PUG0206	10774	6"	60-152
PUG0208	10776	8"	80-203
PUG0212	10777	10"	110-250

- High grade chrome vanadium alloy steel
- AOK special heat treatment techniques
- Interchangeable tip with a retaining ball
- Double joint legs grip automatically
- can be used as an internal or external puller by simply reversing the spindle

## PUG03

### 3 Jaw Gear Puller



A.O.K Item No.	KC Equivalent	Size	Range (mm)
PUG0303	10780	3"	40-76
PUG0304	10782	4"	50-102
PUG0306	10784	6"	60-152
PUG0308	10786	8"	80-203

- High grade chrome vanadium alloy steel
- AOK special heat treatment techniques
- Interchangeable tip with a retaining ball
- Double joint legs grip automatically
- Can be used as an internal or external puller by simply reversing the spindle

## PUG12

### 2 Leg Sliding Gear Puller

A.O.K Item No.	KC Equivalent	Size	Range (mm)
PUG12080	10790	80	30-80
PUG12120	10792	120	30-120
PUG12200	10796	200	40-200

- High grade chrome vanadium alloy steel
- AOK special heat treatment techniques
- can be used as an internal or external puller by simply reversing the spindle



18.A.O.K

## PUG23

### 3-in-1 Gear Puller

A.O.K Item No.	KC Equivalent	Size	Range (mm)
PUG2304	-	4"	76-102
PUG2307	-	7"	76-178

- High grade chrome vanadium alloy steel
- AOK special heat treatment techniques
- Interchangeable tip with a retaining ball
- Spring locking mechanism provides easy operations of switching functions
- Can be used as an internal or external puller by flipping the jaws
- Can be used as a 2 jaw or 3 jaw gear puller



# 18. A.O.K

## DEWK10

### Double End Socket Wrench Set 10pc



#### CONTENTS

6 x 7, 8 x 9, 10 x 11, 12 x 13, 14 x 15, 16 x 17, 18 x 19, 20 x 22mm

Bar 220mm, Bar 300mm

## SDVK-7

### Slotted and Phillips Insulated Screwdriver Set 7pc



#### CONTENTS

4pc Slotted screwdriver, size: SL2.5, SL3.5, SL5.5, SL6.5

2pc Phillips screwdriver, size: PH1, PH2

1pc Voltage tester, size: SL3.0

## BTHK2-8T

### 1/4" Shank Tamperproof Star Bit Set 8pc



#### CONTENTS

7pc Tamperproof STar Bits: T10, T15, T20, T25, T27, T30, T40

1pc Offset Bit Holder

**HKK**

## L Handle Ball Point Hex Key Wrench Set 9pc

**Metric**

CONTENTS (HKK-9)  
(KC No. A13084)

1.5, 2, 2.5, 3, 4, 5, 6, 8, 10mm

**AF**

CONTENTS (HKK-9I)  
(KC No. A13082)

1/16", 5/64", 3/32", 1/8", 5/32", 3/16", 1/4", 5/16", 3/8"



18.A.O.K

**HAC-12I**

## 12" High Tension Hacksaw



(KC No. 12262)

**UKF-12404**

## Safety Retractable Knife



(KC No. 12404)





# KC Tools 'Hassle-Free' Warranties

The "Hassle-Free" warranties referred to below are provided by KC Tools.

Subject to the exclusions set out in these terms, the below products sold and marketed by KC Tools are warrantied against faulty workmanship and materials on terms set out below.

KC Tools provides a range of "Hassle-Free" warranty periods for the KC Tools products it supplies, including but not limited to the following:

For **KC Tools Quality Tools**, you can make a claim under KC Tools "Hassle-Free" warranty for the replacement or repair of products which have faulty workmanship or materials for the 'lifetime' of the product. 'Lifetime' of the product may vary from product to product.

For **KC Impact Tools** products you can make a claim under KC Tools "Hassle-Free" warranty for the replacement or repair of products which have faulty workmanship or materials for the 'lifetime' of the product. Universal Joints are covered by a limited 12 month warranty effective from the date of purchase.

For **KC Air Tools** products you can make a claim under KC Tools "Hassle-Free" warranty for the replacement or repair of products which have faulty workmanship or materials for 24 months from the date of purchase. Pneumatic tools require daily oiling with KC TOOLS recommended air tool oil. Failure to comply with tool maintenance may void warranty.

For **KC Specialty Tools** products you can make a claim under KC Tools "Hassle-Free" warranty for the replacement or repair of products which have faulty workmanship or materials for 12 months from the date of purchase.

For **KC Automotive Tools** products you can make a claim under KC Tools "Hassle-Free" warranty for the replacement or repair of products which have faulty workmanship or materials for 12 months from the date of purchase.

For **KC Garage Equipment** products you can make a claim under KC Tools "Hassle-Free" warranty for the replacement or repair of products which have faulty workmanship or materials for 24 months from the date of purchase.

For **ProAm Tools** products you can make a claim under KC Tools "Hassle-Free" warranty for the replacement or repair of products which have faulty workmanship or materials for the 'lifetime' of the product. 'Lifetime' of the product may vary from product to product.

The benefits conferred by these warranties are in addition to any other rights and remedies you may have under the Australian Consumer Law and/or other applicable laws.

## WARRANTY EXCLUSIONS

Each KC Tools Product is designed and manufactured for a specific purpose. KC Tool warranties do not cover products that have been used for purposes other than for its intended use, or that is misused, abused or subjected to normal wear and tear, or products which have not been correctly maintained.

## KC Tools warranties also do not apply to the following products:

- Sockets used on impact guns (not including impact sockets)
- Screwdrivers used as chisels or tyre levers
- Ratchets that have been affected by normal wear and tear or that have been dented, grooved and broken
- Circlip Plier Tips
- Extension Bars and Flex Handles that have had pipe applied for extra leverage or have been struck with a hammer
- Storage (except where specified)
- Taps and Dies
- Hexagon Keys / TORX\* Keys
- Power Driving Bits and Impact Driver Bits
- Cold Chisels & Punches
- Screw Extractors
- Drill Bits
- Hexagon / Torx\* Bits
- Consumable products (including but not exclusive to: knife blades, hack saw blades, drill bits, augers, grinding wheels, tyres, vacuum bags, nozzles, globes, LED's, batteries, fittings, springs, blades, chucks, chisels, pads or any other such attachments
- Serviceable parts (including but not exclusive to: bearings, seals, filters, spark plugs, globes, belts, batteries, fluids, fittings, springs)
- Castor wheels / Creeper wheels
- Bolt Cutter Jaws

KC Tools "Hassle-Free" warranties also do not cover damage to or loss of items stored in any KC Tools storage boxes (such as tool boxes or vehicle storage boxes).

## WARRANTY CLAIMS

If you make a claim under the KC Tools "Hassle-Free" warranty and none of the exclusions set out above apply, KC Tools will at its election, repair or replace the KC Tools product under warranty and return the repaired or replacement product to the purchaser at KC Tool's cost.

All repairs conducted on KC Tools products under this "Hassle-Free" warranty must be carried out by an authorised KC Tools repair agent.

## CONSUMER WARRANTIES

KC Tools products come with warranties that cannot be excluded under the Australian Consumer Law. You are entitled to a replacement or refund for a major failure and compensation for any other reasonably foreseeable loss or damage. You are also entitled to have the goods repaired or replaced if the goods fail to be of acceptable quality and the failure does not amount to a major failure.

If you have any queries, please contact KC Tools in your local state for further information.

# Conversion Table

Fraction	Decimal	mm	Fraction	Decimal	mm	Fraction	Decimal	mm
1/64	0.0156	0.3969	11/16	0.6875	17.4625	1 23/64	1.3594	34.5281
1/32	0.0313	0.7938	45/64	0.7031	17.8594	1 3/8	1.375	34.925
3/64	0.0469	1.1906	23/32	0.7188	18.2563	1 25/64	1.3906	35.3219
1/16	0.0625	1.5875	47/64	0.7344	18.6531	1 13/32	1.4063	35.7188
5/64	0.0781	1.9844	3/4	0.75	19.05	1 27/64	1.4219	36.1156
3/32	0.0938	2.3813	49/64	0.7656	19.4469	1 7/16	1.4375	36.5125
7/64	0.1094	2.7781	25/32	0.7813	19.8438	1 29/64	1.4531	36.9094
1/8	0.125	3.175	51/64	0.7969	20.2406	1 15/32	1.4688	37.3063
9/64	0.1406	3.5719	13/16	0.8125	20.6375	1 31/64	1.4844	37.7031
5/32	0.1563	3.9688	53/64	0.8281	21.0344	1 1/2	1.5	38.1
11/64	0.1719	4.3656	27/32	0.8438	21.4313	1 33/64	1.5156	38.4969
3/16	0.1875	4.7625	55/64	0.8594	21.8281	1 17/32	1.5313	38.8938
13/64	0.2031	5.1594	7/8	0.875	22.225	1 35/64	1.5469	39.2906
7/32	0.2188	5.5563	57/64	0.8906	22.6219	1 9/16	1.5625	39.6875
15/64	0.2344	5.9531	29/32	0.9063	23.0188	1 37/64	1.5781	40.0844
1/4	0.25	6.35	59/64	0.9219	23.4156	1 19/32	1.5938	40.4813
17/64	0.2656	6.7469	15/16	0.9375	23.8125	1 39/64	1.6094	40.8781
9/32	0.2813	7.1438	61/64	0.9531	24.2094	1 5/8	1.625	41.275
19/64	0.2969	7.5406	31/32	0.9688	24.6063	1 41/64	1.6406	41.6719
5/16	0.3125	7.9375	63/64	0.9844	25.0031	1 21/32	1.6563	42.0688
21/64	0.3281	8.3344	1	1	25.4	1 43/64	1.6719	42.4656
11/32	0.3438	8.7313	1 1/64	1.0156	25.7969	1 11/16	1.6875	42.8625
23/64	0.3594	9.1281	1 1/32	1.0313	26.1938	1 45/64	1.7031	43.2594
3/8	0.375	9.525	1 3/64	1.0469	26.5906	1 23/32	1.7188	43.6563
25/64	0.3906	9.9219	1 1/16	1.0625	26.9875	1 47/64	1.7344	44.0531
13/32	0.4063	10.3188	1 5/64	1.0781	27.3844	1 3/4	1.75	44.45
27/64	0.4219	10.7156	1 3/32	1.0938	27.7813	1 49/64	1.7656	44.8469
7/16	0.4375	11.1125	1 7/64	1.1094	28.1781	1 25/32	1.7813	45.2438
29/64	0.4531	11.5094	1 1/8	1.125	28.575	1 51/64	1.7969	45.6406
15/32	0.4688	11.9063	1 9/64	1.1406	28.9719	1 13/16	1.8125	46.0375
31/64	0.4844	12.3031	1 5/32	1.1563	29.3688	1 53/64	1.8281	46.4344
1/2	0.5	12.7	1 11/64	1.1719	29.7656	1 27/32	1.8438	46.8313
33/64	0.5156	13.0969	1 3/16	1.1875	30.1625	1 55/64	1.8594	47.2281
17/32	0.5313	13.4938	1 13/64	1.2031	30.5594	1 7/8	1.875	47.625
35/64	0.5469	13.8906	1 7/32	1.2188	30.9563	1 57/64	1.8906	48.0219
9/16	0.5625	14.2875	1 15/64	1.2344	31.3531	1 29/32	1.9063	48.4188
37/64	0.5781	14.6844	1 1/4	1.25	31.75	1 59/64	1.9219	48.8156
19/32	0.5938	15.0813	1 17/64	1.2656	32.1469	1 15/16	1.9375	49.2125
39/64	0.6094	15.4781	1 9/32	1.2813	32.5438	1 61/64	1.9531	49.6094
5/8	0.625	15.875	1 19/64	1.2969	32.9406	1 31/32	1.9688	50.0063
41/64	0.6406	16.2719	1 5/16	1.3125	33.3375	1 63/64	1.9844	50.4031
21/32	0.6563	16.6688	1 21/64	1.3281	33.7344	2	2	50.8
43/64	0.6719	17.0656	1 11/32	1.3438	34.1313			

Ft. Lbs.	Nm	Ft. Lbs.	Nm	Ft. Lbs.	Nm	Ft. Lbs.	Nm
1	1.36	31	42	61	82.7	91	123.4
2	2.7	32	43.4	62	84.1	92	125
3	4.1	33	44.8	63	85.4	93	126.1
4	5.4	34	46.1	64	86.8	94	127.5
5	6.8	35	47.5	65	88.1	95	129
6	8.1	36	48.8	66	90	96	130.2
7	9.5	37	50.2	67	90.9	97	131.5
8	10.9	38	52	68	92.2	98	133
9	12.2	39	52.9	69	93.6	99	134.2
10	13.6	40	54.2	70	94.9	100	135.6
11	14.9	41	55.6	71	96.3	110	149.2
12	16.3	42	57	72	97.6	115	156
13	17.6	43	58.3	73	99	120	163
14	19	44	60	74	100.3	125	170
15	20.3	45	61	75	102	130	176.3
16	21.7	46	62.4	76	103.1	135	183.1
17	23.1	47	63.7	77	104.4	140	190
18	24.4	48	65.1	78	105.8	145	197
19	25.8	49	66.4	79	107.1	150	203.4
20	27.1	50	67.8	80	108.5	155	210.2
21	28.5	51	69.2	81	110	160	217
22	29.8	52	70.5	82	111.2	165	224
23	31.2	53	71.9	83	112.6	170	231
24	32.5	54	73.2	84	114	175	237.3
25	33.9	55	74.6	85	115.3	180	244.1
26	35.3	56	75.9	86	117	185	251
27	36.6	57	77.3	87	118	190	258
28	38	58	78.7	88	119.3	195	264.4
29	39.3	59	800	89	121	200	271.2
30	40.7	60	81.4	90	122	225	305.1

TO CONVERT	INTO	MULTIPLY BY
Inch Pounds	Foot Pounds	0.0835
Inch Pounds	Newton Meters	0.113
Inch Pounds	Kg Meters	0.0115
Inch Pounds	Kg Centimeters	1.1519
Foot Pounds	Inch Pounds	12
Foot Pounds	Newton Meters	1.356
Foot Pounds	Kg Meters	0.1382
Foot Pounds	Kg Centimeters	13.824
Newton Meters	Inch Pounds	8.844
Newton Meters	Foot Pounds	0.737
Newton Meters	Kg Meters	0.102
Newton Meters	Kg Centimeters	10.2
Kg Meters	Inch Pounds	86.81
Kg Meters	Foot Pounds	7.234
Kg Meters	Newton Meters	9.804
Kg Centimeters	Inch Pounds	0.8681
Kg Centimeters	Foot Pounds	0.0723
Kg Centimeters	Newton Meters	0.098



# Alphabetical Index

Page No.	Category	Page No.	Category	Page No.	Category
145	1000V Combination Plier	208	Air - Riveter	128	Budd Socket - Impacta - 3/4" Dr
145	1000V Diagonal Cutter	204-206	Air - Sander	153-154	C Clamp Locking Plier
145	1000V Long Nose Plier	209	Air - Shears Metal	246	Cabinet - Sandblast
145	1000V Side Cutter	211	Air - Two Way Gun	191	Caliper - Digital
148	4 Point Gripping Plier	204	Angle Grinder - Air	192	Caliper - Inside & Outside
211	Abrasive Blaster Kit - Air	242	Axle Stand	190	Caliper - Vernier
208, 212	Accessories - Air	230	Balancer Puller	57	Cantilever - Toolbox
250	Accessories - Body Repair Kit	176	Ball Pein Hammer	30, 35	Cantilever - Toolkit
51	Accessories - Toolbox	84	Banjo Ratchet - 1" Dr	210	Caulking Gun - Air
46	Adapter - Insert Tray	76, 86	Banjo Ratchet - 1/2" Dr	180	Centre Punch
84	Adaptor - 1" Dr	64, 85	Banjo Ratchet - 1/4" Dr	179	Centre Punch Set
78	Adaptor - 1/2" Dr	81, 87	Banjo Ratchet - 3/4" Dr	236	Chain Wrench
65	Adaptor - 1/4" Dr	69, 85	Banjo Ratchet - 3/8" Dr	39	Chisel - Insert Tray
82	Adaptor - 3/4" Dr	216	Battery - Cleaner Brush	178, 184	Chisel & Punch Set
70	Adaptor - 3/8" Dr	216	Battery - Hydrometer	224	Chuckes
172	Adaptor - Bit	216	Battery - Terminal Cleaner	40	Circlip Plier (mini) - Insert Tray
137	Adaptor - Impacta - 1" Dr	232	Bearing & Seal Installer	151-152	Circlip Plier Set
123	Adaptor - Impacta - 1/2" Dr	232	Bearing Packer	150	Circlip Plier Set - 140mm
137	Adaptor - Impacta - 1-1/2" Dr	228	Bearing Separator	155	Circlip Plier Set - 175mm
130	Adaptor - Impacta - 3/4" Dr	248	Bench Grinder	151	Circlip Plier Set - 180mm
116	Adaptor - Impacta - 3/8" Dr	223	Bench Grinder Brush	151, 155	Circlip Plier Set - 230mm
70	Adaptor - Ratchet - 1/2" Dr	244	Benders - Hydraulic Pipe	149	Circlip Plier Set - Mini
70	Adaptor - Ratchet - 3/8" Dr	237	Benders - Tube	217	Circuit Tester
130	Adaptor Set - Impacta - 3/4" Dr	144	Bent Nose Plier	216	Circuit Tester - Computer Safe
71	Adaptor Set - Power Tool	146	Bent Nose Plier - Mini	45	Circuit Tester - Insert Tray
158, 159	Adjustable Wrench	170	Bit - Hex	217	Circuit Tester - Needle Probe
158	Adjustable Wrench - Hammer	171	Bit - Spline	238	Clamps - Brake Hose
45, 47	Adjustable Wrench - Insert Tray	171	Bit - Star	227	Claw Type Pick Up Tool
159	Adjustable Wrench Set	171	Bit - Tamperproof	176	Club Hammer
211	Air - Abrasive Blaster Kit	172	Bit Adaptor	231	Clutch Aligning Tools
206, 210	Air - Accessories	169, 172	Bit Set	231	Coil Spring Compressor
204, 281-282	Air - Angle Grinder	172, 295	Bit Set - Tamperproof	181	Cold Chisel
210	Air - Body Saw	256	Bit Sets - Drill	179	Cold Chisel Punch Set
210	Air - Caulking Gun	163	Blade Screwdriver	192	Combination - Square
209, 282	Air - Cut Off Tool	250	Body Repair Kit & Accessories	144, 154	Combination Plier
202-203	Air - Die Grinder	210	Body Saw - Air	145	Combination Plier - 1000V
207	Air - Drill	188	Bolt Cutter & Jaws	144	Combination Plier - Heavy Grip
208	Air - Driver Kit	242	Bottle & Squat Bottle Jacks	146	Combination Pliers - Mini
211	Air - Dusters	103, 296	Box Tube Spanner Set	41, 47	Combination Spanner - Insert Tray
211	Air - Engine Cleaning Gun	245	Bracket - Swivel - Air Hose	90, 96	Combination Spanner - Short
212	Air - Filter Regulator	238	Brake - Adjusting Tool	90-92, 104-106	Combination Spanner Set
210	Air - Flux Chipper	238	Brake - Spring Compressor	234-235	Compression Tester
211	Air - Grease Gun Kit	238	Brake - Spring Tool	238	Compressor - Brake Spring
207, 283	Air - Hammer	238	Brake Bleeder - One Man	231	Compressor - Coil Spring
245	Air - Hose Reel Retractable	238	Brake Hose Clamps	232	Compressor - Piston Ring
212-213	Air - Hoses	239	Brake Spreaders	233	Compressor - Valve Spring
196-200	Air - Impact Wrench	181	Brass Punch	177	Copper Hammer
210	Air - Needle Scaler	182	Brass Punch Set	246-247	Creepers
209	Air - Nibbler	76	Breaker Bar - 1/2" Dr	149	Crimping Plier
212	Air - Oiler Mini	216	Brush - Battery Cleaner	149	Crimping Tool & Stripper
204-205	Air - Palm Sander	223	Brush - Bench Grinder	148	Crimping Tool Kit
206	Air - Polisher	227	Brush - Cleaning Parts	140-141	Crows Foot - Impacta - 1/2" Dr
209	Air - Punch & Flange Tool	223	Brush - Crimped Steel Cup	140	Crows Foot - Impacta - 3/8" Dr
201-202	Air - Ratchet Wrench	223	Brush - Twist Knot	44	Crows Foot - Insert Tray
		223	Brush - Twist Knot Cup	103	Crows Foot Set - 3/8" Dr
		223	Brush - Wire		

139	Crows Foot Set - Impacta - 1/2" Dr
139	Crows Foot Set - Impacta - 3/8" Dr
209	Cut Off Tool - Air
221	Cutter - Rotary Spot Weld
237	Cutters - Tube
188	Cutting Tin Snips
233	Cylinder Hones - 2 & 3 Leg
177	Dead Blow Mallet
144, 154	Diagonal Cutter
145	Diagonal Cutter - 1000V
145	Diagonal Cutter - Heavy Grip
146	Diagonal Cutting Plier - Mini
191	Dial Indicator
202-203	Die Grinder - Air
191	Digital Caliper
192	Divider
218	Dolly - Panel Beating
221	Door Handle Remover
237	Double Flaring Tool Set
212	Double Suction Cup
246	Drain Tank - Oil
207	Drill - Air
256	Drill - Bit Sets
248	Drill Press - Floor Type
249	Drill Vice
208	Driver Kit - Air
249	Drum Pumps
211	Dusters - Air
75	E Socket - 1/2" Dr
46	E Socket - Insert Tray
75	E Socket Set - 1/2" Dr
71, 274	E Socket Set - 1/4" Dr
68, 71, 275, 277	E Socket Set - 3/8" Dr
68, 71, 275, 277	E Socket Set - Tamperproof - 3/8" Dr
71, 274	E Socket Set - Tamperproof- 1/4" Dr
102	E Type Spanner
145	End Cutting Plier
147	End Cutting Plier - Mini
211	Engine Cleaning Gun - Air
227	Engineers Stethoscope
70	Extension - Hex Head - 3/8" Dr
77, 86	Extension - Wobble - 1/2" Dr
65, 86	Extension - Wobble - 1/4" Dr
70, 85-86	Extension - Wobble - 3/8" Dr
84	Extension Bar - 1" Dr
77	Extension Bar - 1/2" Dr
65	Extension Bar - 1/4" Dr
81, 87	Extension Bar - 3/4" Dr
69-70	Extension Bar - 3/8" Dr
137	Extension Bar - Impacta - 1" Dr
124	Extension Bar - Impacta - 1/2" Dr
130	Extension Bar - Impacta - 3/4" Dr
116	Extension Bar - Impacta - 3/8" Dr
45	Extension Bar - Insert Tray
124	Extension Bar - Rotary - Impacta - 1/2" Dr

130	Extension Bar - Rotary - Impacta - 3/4" Dr
77	Extension Bar Set - 1/2" Dr
70	Extension Bar Set - 3/8" Dr
166	Extra Long Ball Point Hex Key Set
166	Extra Long Hex Key Set
258	Extractor Set - Screw
242	Farm Jack
193	Feeler Gauge
34, 38	Feeler Gauge - Insert Tray
149	Fencing Plier
257	File - Thread
257	File Set
212	Filter Regulator - Air
95-96, 102	Flare Nut Spanner Set
237	Flaring Tool Set - Double
146	Flat Nose Plier - Mini
84	Flex Head Bar - 1" Dr
76	Flex Head Bar - 1/2" Dr
64	Flex Head Bar - 1/4" Dr
81	Flex Head Bar - 3/4" Dr
69	Flex Head Bar - 3/8" Dr
65	Flexible Bar 1/4" Dr
210	Flux Chipper - Air
187	Gasket Scraper Set
193	Gauge - Feeler
191	Gauge Set - Telescopic
92-94, 98-100, 105	Gear Ratchet Spanner Set
249	Grease Gun
211	Grease Gun Kit - Air
248	Grinder - Bench
155	Grip Set
187, 297	Hacksaw
207, 283	Hammer - Air
176, 293	Hammer - Ball Pein
176	Hammer - Club
177	Hammer - Copper
219	Hammer - Curved Pein Finish
47	Hammer - Insert Tray
219	Hammer - Light Shrinking
219	Hammer - Pick and Finishing
219	Hammer - Reverse Curve
176	Hammer - Sledge
177	Hammer - Soft Blow
219	Hammer - Straight Pein Finish
251	Hand Riveters
39, 47	Hex & Star - Insert Tray
170	Hex Bit
164	Hex Bolster Screwdriver Set
70	Hex Head Extension - 3/8" Dr
168	Hex Key
40, 43	Hex Key - Insert Tray
168	Hex Key - T-Handle Ball End
166-167, 173	Hex Key Set
166	Hex Key Set - Extra Long
166	Hex Key Set - Extra Long - Ball Point
166	Hex Key Set - Tamper Star

167	Hex Key Set - T-Handle
167	Hex Key Set - T-Handle Ball Point
40	Hollow Punch - Insert Tray
182	Hollow Punch Set
165, 173	Hook & Pick Set
45	Hook & Pick Set - Insert Tray
159	Hook Wrench Set
238	Hose Pinchers
148	Hose Plier
245	Hose Reel - Retractable Air
212-213	Hoses - Air
244	Hydraulic Pipe Benders
228	Hydraulic Puller Kit
216	Hydrometer Battery
165	Impact Driver Kit 8mm Shank
196-200	Impact Wrench - Air
137	Impacta - Adaptor - 1" Dr
137	Impacta - Adaptor - 1-1/12" Dr
130	Impacta - Adaptor - 3/4" Dr
128	Impacta - Budd Socket - 3/4" Dr
140-141	Impacta - Crows Foot - 1/2" Dr
140	Impacta - Crows Foot - 3/8" Dr
141	Impacta - Crows Foot Set - 1/2" Dr
139	Impacta - Crows Foot Set - 3/8" Dr
137	Impacta - Extension Bar - 1" Dr
130	Impacta - Extension Bar - 3/4" Dr
136	Impacta - In-Hex - Socket - 1" Dr
129	Impacta - In-Hex - Socket - 3/4" Dr
129	Impacta - In-Hex - Socket Set - 3/4" Dr
137	Impacta - Pins & "O" Rings - 1" Dr
124	Impacta - Pins & "O" Rings - 1/2" Dr
130	Impacta - Pins & "O" Rings - 3/4" Dr
124	Impacta - Rotary Extension Bar - 1/2" Dr
130	Impacta - Rotary Extension Bar - 3/4" Dr
132-135	Impacta - Socket - 1" Dr
137-137	Impacta - Socket - 1-1/2" Dr
131	Impacta - Socket Set - 1" Dr
136	Impacta - Square Socket - 1" Dr
128	Impacta - Square Socket - 3/4" Dr
123	Impacta - Star Bit Set - 1/2" Dr
124	Impacta - Torsion Bar - 1/2" Dr
124	Impacta - Torsion Bar Set - 1/2" Dr
136	Impacta - Universal Joint - 1" Dr
130	Impacta - Universal Joint - 3/4" Dr
123	Impacta Adaptor - 1/2" Dr
116	Impacta Adaptor - 3/8" Dr
130	Impacta Adaptor Set - 3/4" Dr
124	Impacta Extension Bar - 1/2" Dr
116	Impacta Extension Bar - 3/8" Dr
119-120	Impacta Socket - 1/2" Dr
126-128	Impacta Socket - 3/4" Dr
115	Impacta Socket - 3/8" Dr

# Alphabetical Index

122	Impacta Socket - In-Hex - 1/2" Dr
43	Impacta Socket - Insert Tray
120	Impacta Socket Flip - 1/2" Dr
116-118	Impacta Socket Set - 1/2" Dr
125	Impacta Socket Set - 3/4" Dr
114	Impacta Socket Set - 3/8" Dr
121-122	Impacta Socket Set - In-Hex - 1/2" Dr
123	Impacta Universal Joint - 1/2" Dr
116	Impacta Universal Joint - 3/8" Dr
180	Industrial Centre Punch
179	Industrial Centre Punch Set
225	Inflator/Deflators
136	In-Hex - Socket - Impacta - 1" Dr
129	In-Hex - Socket - Impacta - 3/4" Dr
129	In-Hex - Socket Set - Impacta - 3/4" Dr
74-75	In-Hex Socket - 1/2" Dr
68, 27	In-Hex Socket - 3/8" Dr
122	In-Hex Socket - Impacta - 1/2" Dr
74	In-Hex Socket Set - 1/2" Dr
68	In-Hex Socket Set - 3/8" Dr
121-122	In-Hex Socket Set - Impacta - 1/2" Dr
37	Insert Tray - Drawer
35-48	Insert Trays - Foam
47-48	Inserts Trays - Plastic
232	Installer - Bearing & Seal
242	Jack - Bottle & Squat
242	Jack - Farm
243	Jack - Low Profile
243-244	Jack - Transmission
243	Jack - Trolley
164	Jumbo Screwdriver Set
167	Key Set - T-Handle
186, 297	Knives
81	L Handle Bar - 3/4" Dr
230	Leg Pullers
182	Letter & Number Punch Set
230	Lifter - Tie Rod End
244	Load Leveller
152	Lock Ring Plier
152-153, 155, 292-293	Locking Plier
222	Lockout Tool Set
153	Long Nose - Locking Plier
144, 154	Long Nose Plier
147	Long Nose Plier - 45° Bent
147	Long Nose Plier - 90° Bent
144	Long Nose Plier - Heavy Grip
146	Long Nose Plier - Mini
147	Long Nose Plier - Straight
145	Long Nose Pliers - 1000V
45	Long Ring Spanner - Insert Tray
94, 100, 291	Long Ring Spanner Set
243	Low Profile Jacks

227	Magnetic Parts Dishes
226	Magnetic Pick Up Tools
192	Magnetic Stand
177	Mallet - Dead Blow
177	Mallet - Rubber
45	Measuring - Insert Tray
191	Micrometer Set
149	Mig Welding Plier
212	Mini Oiler - Air
226	Mirror Tools
45	Mirrors - Insert Tray
34, 38, 44	Multigrip - Insert Tray
147	Multigrip Plier - Curved Jaw
147, 155	Multigrip Plier - Straight Jaw
217	Multimeter - Digital
71, 85, 274-275	Multiple Drive Sets
210	Needle Scaler - Air
209	Nibbler - Air
246	Nozzle - Sandblast Ceramic
182	Number & Letter Punch Set
257	Nut Splitter
102, 106, 292	Obstruction Spanner
95, 101	Offset 45° Ring - Spanner
165	Offset Screwdriver
109	Offset Single Podger Spanner
246	Oil Drain Tank
235-236	Oil Filter Removers
236	Oil Filter Wrench
235	Oil Pressure Tester
249	Oil Syringe
43	Open End Spanner - Insert Tray
95, 101	Open End Spanner Set
204-205	Palm Sander - Air
245	Part Washers
227	Parts - Cleaning Brush
227	Parts - Magnetic Dishes
163	Phillips Screwdriver
165, 173	Pick & Hook Set
227	Pick Up Tools - Claw Type
226	Pick Up Tools - Magnetic
180	Pin Punch - Long & Short Series
178	Pin Punch Set - Long & Short Series
137	Pins & "O" Rings - Impacta - 1" Dr
124	Pins & "O" Rings - Impacta - 1/2" Dr
130	Pins & "O" Rings - Impacta - 3/4" Dr
244	Pipe Benders - Hydraulic
158	Pipe Wrench - Aluminium
158	Pipe Wrench - Steel
232	Piston Ring Compressor
148	Plier - 4 Point Gripping
144	Plier - Bent Nose
146	Plier - Bent Nose - Mini
151-152	Plier - Circlip Set

150	Plier - Circlip Set - 140mm
155	Plier - Circlip Set - 175mm
151	Plier - Circlip Set - 180mm
151, 155	Plier - Circlip Set - 230mm
149	Plier - Circlip Set - Mini
144, 154	Plier - Combination
145	Plier - Combination - 1000V
146	Plier - Combination - Mini
149	Plier - Crimping
144, 154	Plier - Diagonal Cutter
145	Plier - Diagonal Cutter - 1000V
146	Plier - Diagonal Cutting - Mini
145	Plier - End Cutting
147	Plier - End Cutting - Mini
149	Plier - Fencing
146	Plier - Flat Nose - Mini
144	Plier - Heavy Grip - Combination
145	Plier - Heavy Grip - Diagonal Cutter
144	Plier - Heavy Grip - Long Nose
148	Plier - Hose
34, 38, 43, 47	Plier - Insert Tray
152	Plier - Lock Ring
152-153, 155	Plier - Locking
153-154	Plier - Locking - C Clamp
154	Plier - Locking - Sheet Metal
153	Plier - Locking - Long Nose
154	Plier - Locking - Welding Clamp
144, 154	Plier - Long Nose
145	Plier - Long Nose - 1000V
147	Plier - Long Nose - 45° Bent
147	Plier - Long Nose - 90° Bent
146	Plier - Long Nose - Mini
147	Plier - Long Nose - Straight
149	Plier - Mig Welding
147	Plier - Multigrip - Curved Jaw
147, 155	Plier - Multigrip - Straight Jaw
145	Plier - Side Cutter - 1000V
148	Plier - Trimming
148	Plier - Wheel Balancing
148	Plier - Wire Rope Cutting
148	Plier - Wire Twisting
155	Plier Set
152	Plier Set - Snap Ring
44	Podger - Insert Tray
109	Podger Spanner - Single Offset
108	Podger Spanner - Socket
206	Polisher - Air
251	Porta Power
71	Power Tool - Adaptor Set
164, 173	Precision Screwdriver Set
245	Press - Shop
183	Pry Bar
183	Pry Bar Set
230, 294	Puller - 2 Leg
230, 294-295	Puller - 3 Leg

230	Puller - Balancer
232	Puller - Seal
257	Puller - Stud
229	Puller Kit - Bearing
229	Puller Kit - Dent
229	Puller Kit - Hub & Dent
228	Puller Kit - Hydraulic
234	Pump Tester - Vacuum & Fuel
249	Pumps - Drum
181	Punch - Brass
180	Punch - Centre
180	Punch - Industrial Centre
39, 47	Punch - Insert Tray
180	Punch - Long & Short Series Pin
181	Punch - Roofing
178, 184	Punch & Chisel Set
209	Punch & Flange Tool - Air
182	Punch Set - Brass
179	Punch Set - Centre
179	Punch Set - Cold Chisel
182	Punch Set - Hollow
179	Punch Set - Industrial Centre
182	Punch Set - Letter & Number
178	Punch Set - Long & Short Series Pin
179	Punch Set - Starter Drift & Tamper
239	Radiator Fin Straightening Tool
78	Ratchet - Adaptor - 1/2" Dr
84	Ratchet - Banjo - 1" Dr
76, 86	Ratchet - Banjo - 1/2" Dr
64, 85	Ratchet - Banjo - 1/4" Dr
81, 87	Ratchet - Banjo - 3/4" Dr
69, 85	Ratchet - Banjo - 3/8" Dr
70	Ratchet Adaptor - 3/8" Dr
45	Ratchet Handle - Insert Tray
92-94, 98-100, 105	Ratchet Spanner - Gear
34	Ratchet Spanner - Insert Tray
201-202, 281	Ratchet Wrench - Air
221	Remover - Door Handle
235-236	Remover - Oil Filters
257	Remover - Stud
221	Remover - Windscreen
231	Remover Set - Sump Plug
95, 101	Ring Spanner - 45° Offset
42	Ring Spanner - Insert Tray
94, 100, 291	Ring Spanner - Long
208	Riveter - Air
251	Riveter - Hand
52, 55	Roll Cabinet - 11 Drawer
51	Roll Cabinet - 13 Drawer
51, 56	Roll Cabinet - 7 Drawer
11-24, 33	Roll Cabinets - Toolkit
181	Roofing Punch
124	Rotary Extension Bar - Impacta - 1/2" Dr
130	Rotary Extension Bar - Impacta - 3/4" Dr
221	Rotary Spot Weld Cutter
177	Rubber Mallet

190	Ruler
239	Safety Glasses
246	Sandblast Cabinet
246	Sandblast Unit
204-205	Sander - Air
187	Scissor - Multi-purpose Gasket
44	Scraper - Insert Tray
187	Scraper Set - Gasket
258	Screw Extractor Sets
163	Screwdriver - Blade
34, 38, 42, 47	Screwdriver - Insert Tray
165	Screwdriver - Offset
163	Screwdriver - Phillips
163	Screwdriver - Star
163	Screwdriver - Tamperproof
162, 172, 296	Screwdriver Set
164	Screwdriver Set - Hex Bolster
164	Screwdriver Set - Jumbo
164, 173	Screwdriver Set - Precision
162, 165	Screwdriver Set - Star
162	Screwdriver Set - Tamperproof
190	Scribber Double Pointed
232	Seal & Bearing Installer
232	Seal Puller
231	Separator - 3 Function Kit
228	Separator - Bearing
231	Separators
260-263	Shadowboard
209	Shears Metal - Air
154	Sheet Metal Locking Plier
245	Shop Press
145	Side Cutter - 1000V
176	Sledge Hammer
84	Sliding T-Handle - 1" Dr
76	Sliding T-Handle - 1/2" Dr
64	Sliding T-Handle - 1/4" Dr
81, 87	Sliding T-Handle - 3/4" Dr
69	Sliding T-Handle - 3/8" Dr
108-109, 291	Slogging Spanner
152	Snap Ring Plier Set
83-84	Socket - 1" Dr
73-74, 274-275	Socket - 1/2" Dr
63, 271	Socket - 1/4" Dr
80	Socket - 3/4" Dr
66-67, 271, 272, 275	Socket - 3/8" Dr
128	Socket - Budd - Impacta - 3/4" Dr
75	Socket - E - 1/2" Dr
132-135	Socket - Impacta - 1" Dr
119-121	Socket - Impacta - 1/2" Dr
119-120	Socket - Impacta - 1/2" Dr
137-138	Socket - Impacta - 1-1/2" Dr
126-128	Socket - Impacta - 3/4" Dr
115	Socket - Impacta - 3/8" Dr
43	Socket - Impacta - Insert Tray
74-75	Socket - In-Hex - 1/2" Dr
68	Socket - In-Hex - 3/8" Dr
136	Socket - In-Hex - Impacta - 1" Dr
122	Socket - In-Hex - Impacta - 1/2" Dr

129	Socket - In-Hex - Impacta - 3/4" Dr
40-41, 43-44, 46, 47-48	Socket - Insert Tray
78	Socket - Spark Plug - 1/2" Dr
70	Socket - Spark Plug - 3/8" Dr
136	Socket - Square - Impacta - 1" Dr
128	Socket - Square - Impacta - 3/4" Dr
64	Socket - Star Bit - 1/4" Dr
46	Socket E - Insert Tray
120	Socket Flip - Impacta - 1/2" Dr
78	Socket Holder
78	Socket Holder Set
108, 291	Socket Podger Spanner
83	Socket Set - 1" Dr
72, 85	Socket Set - 1/2" Dr
62, 71, 85	Socket Set - 1/4" Dr
79, 86	Socket Set - 3/4" Dr
66, 68, 71, 85	Socket Set - 3/8" Dr
75	Socket Set - E - 1/2" Dr
131	Socket Set - Impacta - 1" Dr
116-118	Socket Set - Impacta - 1/2" Dr
116-118	Socket Set - Impacta - 1/2" Dr
125	Socket Set - Impacta - 3/4" Dr
114	Socket Set - Impacta - 3/8" Dr
74	Socket Set - In-Hex - 1/2" Dr
68	Socket Set - In-Hex - 3/8" Dr
129	Socket Set - In-Hex - Impacta - 3/4" Dr
121-122	Socket Set - In-Hex - Impacta - 1/2" Dr
121	Socket Set - Thin Wall - 1/2" Dr
121	Socket -Thin Wall - 1/2" Dr
82	Socket -Truck Wheel Locknut
82	Socket Wrench - T-Handle
177	Soft Blow Hammer
220	Soldering Irons
90-92, 97, 104-106	Spanner - Combination
41, 47	Spanner - Combination Insert Tray
90, 96,	Spanner - Combination Short
102	Spanner - E Type
95-96, 102	Spanner - Flare Nut
92-94, 98-100, 104	Spanner - Gear Ratchet
41, 42	Spanner - Insert Tray
94, 100, 291	Spanner - Long Ring
45	Spanner - Long Ring - Insert Tray
95, 101	Spanner - Open End
45	Spanner - Open End - Insert Tray
34	Spanner - Ratchet Insert Tray
94-95, 100-101, 291	Spanner - Ring
44	Spanner - Ring - Insert Tray
95, 101	Spanner - Ring 45° Offset
109	Spanner - Single Offset Podger
108-109	Spanner - Slogging
108	Spanner - Socket Podger
103, 296	Spanner Set - Box Tube
102, 106, 292	Spanner Set - Obstruction



# Alphabetical Index

78	Spark Plug Socket - 1/2" Dr
70	Spark Plug Socket - 3/8" Dr
76	Speed Brace - 1/2" Dr
64	Spinner Handle 1/4" Dr
171	Spline Bit
221	Spot Weld Cutter - Rotary
223	Spray Gun
239	Spreaders - Brake
136	Square Socket - Impacta - 1" Dr
128	Square Socket - Impacta - 3/4" Dr
242	Squat Bottle Jacks
162	Star - Screwdriver Set
168	Star & Tamperproof Key
171	Star Bit
71, 275	Star Bit Set - 1/4" Dr
68, 71, 275, 277	Star Bit Set - 3/8" Dr
123	Star Bit Set - Impacta - 1/2" Dr
71, 275	Star Bit Set - Tamperproof - 1/4" Dr
68, 71, 275, 277	Star Bit Set - Tamperproof - 3/8" Dr
163	Star Screwdriver
180	Starter Drift & Tamper Punch
179	Starter Drift & Tamper Punch Set
249	Steel Vice
227	Stethoscope - Engineers
239	Straightening Tool - Radiator Fin
236	Strap Wrench
149	Stripper & Crimping Tool
149	Stripper Wire - Automatic
257	Stud Remover & Puller
212	Suction Cup - Double
231	Sump Plug Remover Set
216	Switch Remover
245	Swivel Bracket - Air Hose
212	Swivel Joint - Air
180	Tamper & Starter Drift Punch
179	Tamper & Starter Drift Punch Set
166	Tamper Star Hex Key Set
162	Tamperproof - Screwdriver Set
168	Tamperproof & Star Key
171	Tamperproof Bit
172, 295	Tamperproof Bit Set
163	Tamperproof Screwdriver
253-256	Tap & Die Sets
190	Tape Measure
191	Telescopic Set - Gauge
216	Terminal Battery Cleaner
234-235	Tester - Compression
235	Tester - Oil Pressure
234	Tester - Vacuum & Fuel Pump
168	T-Handle Ball End Hex Key
167	T-Handle Ball Point Hex Key Set
167	T-Handle Hex Key Set
167	T-Handle Key Set
82	T-Handle Socket Wrench
121	Thin Wall Socket - 1/2" Dr

121	Thin Wall Socket Set - 1/2" Dr
257	Thread Files
252	Thread Form Symbols
230	Tie Rod End Lifter
217	Timing Light - Power
188	Tin Snips - Cutting
44	Tinsnip - Insert Tray
231	Tool Kit - Separator - 3 Function
222	Tool Set - Lockout
247	Tool Trolley
50, 55	Toolbox - 10 Drawer
57	Toolbox - 2 Drawer
52	Toolbox - 3 Drawer
50	Toolbox - 5 Drawer
56	Toolbox - 6 Drawer
50, 52	Toolbox - 7 Drawer
56	Toolbox - 9 Drawer
51	Toolbox - Accessories
30, 35	Toolbox - Cantilever Toolkit
57	Toolbox - Handyman
58	Toolbox - Steel Truck Wheel
7-17, 20, 24-27, 31-34	Toolbox - Toolkit
7-35	Toolkits
258	Torches
266-271, 266-269	Torque Wrench
124	Torsion Bar - Impacta - 1/2" Dr
124, 277	Torsion Bar Set
243-244	Transmission Jacks
221	Trim Tool Universal
148	Trimming Plier
247	Trolley - Tools
243	Trolley Jacks
58	Truck Wheel Boxes - Steel
82	Truck Wheel Locknut Socket
237	Tube Benders
237	Tube Cutters
211	Two Way Gun - Air
225	Tyre Gauges
183	Tyre Lever
77	Universal Joint - 1/2" Dr
65	Universal Joint - 1/4" Dr
82	Universal Joint - 3/4" Dr
70	Universal Joint - 3/8" Dr
136	Universal Joint - Impacta - 1" Dr
123	Universal Joint - Impacta - 1/2" Dr
130	Universal Joint - Impacta - 3/4" Dr
116	Universal Joint - Impacta - 3/8" Dr
221	Universal Trim Tool
28-29	Ute Box Toolkits
58-59	Ute Boxes
233-234	Valve Spring Compressor
224	Valve Tool - 4 in 1
190	Vernier Caliper
249	Vices - Steel & Drill
57	Wall Cabinet - Box

30	Wall Cabinet - Toolkit
154	Welding Clamp Locking Plier
148	Wheel Balancing Plier
158	Wide Opening Wrench
221	Windscreen Remover
222	Wire Brushes
148	Wire Rope Cutting Plier
149	Wire Stripper - Automatic
148	Wire Twisting Plier
77, 86	Wobble Extension - 1/2" Dr
65, 86	Wobble Extension - 1/4" Dr
70, 85-86	Wobble Extension - 3/8" Dr
258	Work Lights
159	Wrench - Hook Set
158, 159	Wrench - Adjustable
45	Wrench - Adjustable - Insert Tray
158	Wrench - Adjustable Hammer
159	Wrench - Adjustable Set
236	Wrench - Chain
236	Wrench - Oil Filter
158	Wrench - Pipe - Aluminium
158	Wrench - Pipe - Steel
236	Wrench - Strap
257	Wrench - Stud Puller
266-271, 266-269	Wrench - Torque
158	Wrench - Wide Opening

# Numerical Index

Part No.	Page No.
07020	178
07026	182
07027	181
07028	181
07118	183
07119	183
07121	183
07125	183
07126	183
08000	221
08001	221
08002	221
08010	222
08020	221
08028	222
08030	221
08050	182
08100	233
08103	187
08110	229
08111	231
08112	231
08114	233
08115	232
08116	232
08117	233
08119	234
08120	234
08122	234
08124	235
08128	235
08133	235
08134	235
08136	235
08137	236
08138	236
08139	236
08165	238
08200	232
08202	238
08203	238
08203	222
08205	238
08206	238
08206	222
08207	238
08209	239
08214	239
08220	237
08225	237
08234	149
08300	226
08301	226
08305	226
08306	226

08308	226
08310	226
08311	226
08312	226
08313	226
08314	226
08319	190
08320	239
08328	237
08329	237
08330	183
08331	183
08334	232
08345	257
08350	227
08412	216
08415	227
08416	227
08417	227
08419	220
08425	220
08427	220
08429	220
08550	224
08552	224
08553	224
08554	224
08558	224
08566	225
08568	225
08570	225
08572	225
08575	225
08576	225
08610	257
08611	257
08612	257
08614	257
08615	257
08680	248
08682	248
08684	248
08686	248
09200	222
09201	222
09202	222
09207	222
09208	222
09210	223
09211	223
09212	223
09213	223
09214	223
09215	223
09240	223
09241	223

09242	223
09246	223
09248	223
10013	164
10027	173
10070	182
10071	182
10072	182
10073	182
10074	182
10075	182
10076	182
10077	182
101TK	34
10100	85
10120	85
10150	85
10155	85
10160	85
10162	70
10162A	70
10162B	70
10162C	70
10162D	70
10166	77
10166A	77
10166B	77
10166C	77
10166D	77
10170	85
10175	85
10179	85
10181	65
10187	103
10188	103
10190	68
10191	68
10195	78
10196	78
10197	78
10198	78
10250	108
10251	108
10252	108
10253	108
10254	108
10255	108
10256	108
10257	108
10258	108
10259	108
10261	108
10262	108
10263	108
10264	108
10265	108
10266	108

10267	108
10268	108
10269	108
10280	108
10290	165
10295	249
103TK	32
10305	219
10311	219
10312	219
10313	219
10314	219
10315	177
10316	177
10317	177
10318	177
10319	177
10321	218
10322	218
10323	218
10324	218
10325	218
10326	218
10355	71
10370	250
10371	250
10372	250
10373	250
10374	250
10375	250
10376	250
10377	250
10378	250
10379	250
10395	190
10398	190
10398CP	190
10400	190
10409	231
10412	227
10416	233
10416A	233
10417	233
10417A	233
10418	233
10418A	233
10418B	233
10418C	233
10419	173
10421	236
10422	236
10423	232
10425	216
10426	217
10427	217
10428	217

# Numerical Index

10430	231
10431	231
10432	230
10433	231
10435	237
10436	237
10440	258
10441	258
10444	257
10445	257
10450	224
10451	239
10455	216
10457	216
10458	216
10460	232
10470	249
10473	249
10478	249
10485	249
10490	249
105TK	33
10517	159
10518	159
10519	159
10576	159
10576	159
10578	159
10578	159
10580	159
10582	159
10582	159
106TK	31
10600	173
10601	155
10602	155
10603	155
10604	155
10613	166
10615	166
10616	166
10617	166
10618	155
10619	166
10621	155
10622	155
10623	155
10624	155
10626	151
10629	152
10630	152
10631	251
10632	251
10633	251
10634	251
10635	149

10636	148
10638	149
10639	149
10649	71
10650	71
10664	172
10670	82
10670	165
10696	183
10696	183
10697	183
10697	183
10698	183
10699	183
10701	229
10702	228
10702A	228
10702B	228
10702C	228
10702D	228
10702E	228
10702F	228
10702G	228
10702H	228
10702I	228
10702J	228
10702K	228
10702L	228
10702M	228
10702N	228
10702S	228
10703	228
10704	229
10706	228
10707	228
10708	228
10708	228
10709	228
10712	230
10720	229
10770	230
10772	230
10774	230
10776	230
10777	230
10778	230
10780	230
10782	230
10784	230
10786	230
10788	230
10790	230
10790	230
10792	230
10794	230
10796	230

10820	217
10825	217
10829	247
10830	247
10835	246
10910	82
10911	82
10912	82
10913	82
10914	82
10966	82
10968	82
10972	82
10974	82
10976	82
10978	82
10980	82
10982	82
10984	82
10986	82
10988	82
10990	82
10992	82
10994	82
10996	82
110TK	35
111000	138
111005	138
111010	138
111015	138
111020	138
111025	138
111030	138
111035	138
111040	138
111045	138
111050	138
111055	138
111060	138
111065	138
111070	138
111075	138
111080	138
111085	138
111090	138
111095	138
111100	138
111105	138
111110	138
111115	138
111120	138
111125	138
111130	138
111135	138
111140	138
111145	138

111150	138
111155	138
111160	138
111170	138
111180	138
111190	138
111200	138
111210	138
111220	138
111225	138
111230	138
111235	138
111240	138
111245	138
11200	114
11203	114
112030	137
112032	137
112038	137
112041	137
112046	137
112050	137
112055	137
11206	114
112060	137
112065	137
112070	137
112075	137
112080	137
112085	137
11209	114
112090	137
112095	137
112100	137
112105	137
112110	137
112115	137
112120	137
112125	137
112130	137
112135	137
11214	116
112140	137
112145	137
11215	116
112150	137
112155	137
11216	116
11218	116
11219	116
11220	139
112201	140
112202	140
112203	140
112204	140
112205	140

112206	140
112207	140
112208	140
112209	140
11221	139
112210	140
112211	140
112212	140
112213	140
112214	140
112215	140
112216	140
112217	140
112218	140
112219	140
112220	140
112221	140
112222	140
112223	140
112224	140
112225	140
112226	140
112227	140
112228	140
112229	140
112230	140
112231	140
112232	140
112233	140
112234	140
112235	140
112236	140
112237	140
112238	141
112239	141
112240	141
112241	141
112242	141
112243	141
112244	141
112245	141
112246	141
112247	141
112248	141
112249	141
112250	141
112251	141
112252	141
112253	141
112254	141
112255	141
11226	115
11227	115
11228	115
11229	115
11230	115
112305	138
11231	115
112310	138

112315	138
11232	115
11233	115
11234	115
11235	115
11236	115
11237	115
11238	115
11239	115
11240	115
11241	115
11242	115
11255	115
11256	115
11257	115
11258	115
11259	115
11260	115
11261	115
11262	115
11263	115
11264	115
11266	115
11267	115
11268	115
11269	115
11270	115
11271	115
11272	115
11273	115
11274	115
11275	115
11276	115
11277	115
11278	115
11279	115
11280	115
11281	115
11282	115
11285	115
11286	115
11287	115
11288	115
11289	115
11290	115
11291	115
11292	115
11293	115
11294	115
11300A	117
11300M	117
11301	116
11305	116
11306	121
11307	121
11308	121
113080	138
11309	121
11310	121

113100	138
11311	117
113115	138
11312	121
11314	118
11315-2	117
11316	121
11317	139
11318	139
11320	118
11321	118
11322	121
11323	121
11324A	122
11324M	122
11325	123
11326	123
11327	123
11328	124
11329	124
11330	124
113300	124
113301	124
113302	124
113302	124
113303	124
113304	124
113305	124
113306	124
113307	124
11331	123
11333	120
11334	120
11335	124
11336	124
11338	119
11339	119
11340	119
113400	123
113401	123
113402	123
113403	123
113404	123
113405	123
113406	123
113407	123
113408	123
113409	123
11341	119
113410	123
113411	123
113412	123
11342	119
11343	119
11344	119
11345	119
11346	119
11347	119
11348	119

11349	119
11349	119
11350	119
11351	119
11352	119
11353	119
11354	119
11355	119
11356	119
11357	119
11358	119
11359	119
11360	119
11361	119
11362	119
11363	122
11364	122
11367	124
11370	120
11371	120
11372	120
11373	120
11374	120
11375	120
11376	120
11377	120
11378	120
11379	120
11380	120
11381	120
11382	120
11383	120
11384	120
11385	120
11386	122
11387	122
11388	122
11389	122
11390	122
11391	122
11392	122
11393	122
11394	122
11395	122
11396	122
11397	122
11398	122
11399	122
11400	122
11401	122
11438	119
11440	119
11441	119
11442	119
11443	119
11444	119
11445	119
11446	119



# Numerical Index

11447	119
11448	119
11449	119
11450	119
11451	119
11452	119
11453	119
11454	119
11455	119
11456	119
11457	119
11458	119
11459	119
11460	119
11461	119
11462	119
11463	119
11464	119
11466	119
11470	120
11471	120
11472	120
11473	120
11474	120
11475	120
11476	120
11477	120
11478	120
11479	120
11480	120
11481	120
11482	120
11483	120
11484	120
11485	120
11487	122
11488	122
11489	122
11490	122
11491	122
11492	122
11493	122
11494	122
11495	122
11496	122
11497	122
11498	122
11499	122
11500	126
11501	126
11502	126
11503	126
11504	126
11505	126
11506	126
11507	126

11508	126
11509	126
11510	126
11511	126
11512	126
11513	126
11514	126
11515	126
11516	126
11517	126
11518	126
11519	126
11520	126
11521	126
11522	126
11523	126
11524	126
11525	126
11526	126
11527	126
11528	126
11529	126
11530	126
11531	126
11532	126
11533	126
11534	126
11535	126
11536	126
11537	126
11538	126
11539	126
11540	126
11541	126
11542	126
11543	126
11544	126
11545	126
11546	126
11547	126
11548	127
11549	127
11550	127
11551	127
11552	127
11553	127
11554	127
11555	127
11556	127
11557	127
11558	127
11559	127
11560	127
11561	127
11562	127
11563	127

11564	127
11565	127
11566	127
11567	127
11568	127
11569	127
11570	127
11571	127
11572	127
11573	127
11574	127
11575	127
11576	127
11577	127
11578	127
11579	127
11600	127
11601	127
11602	127
11603	127
11604	127
11605	127
11606	127
11607	127
11608	127
11609	127
11610	127
11611	127
11612	127
11613	127
11614	127
11615	127
11616	127
11617	127
11618	127
11619	127
11620	127
11621	127
11622	127
11623	127
11624	127
11625	127
11626	127
11627	127
11628	127
11630	128
11631	128
11632	128
11633	128
11634	128
11635	128
11636	128
11637	128
11638	128
11639	128
11640	128

11641	128
11642	128
11643	128
11644	128
11645	128
11646	128
11647	128
11648	128
11649	128
11650	128
11651	128
116520	129
116521	129
116522	129
116523	129
116524	129
116525	129
116527	129
116528	129
116529	129
116530	129
116531	129
116532	129
116533	129
116538	129
116540	129
116541	129
116544	129
116546	129
116547	129
116548	129
116549	129
116550	129
116553	129
116555	129
116556	129
116560	129
11670	130
11672	130
11673	130
11675	130
11676	130
11679	130
11680	130
11681	130
11682	130
11683	130
11684	130
11685	130
11689	128
11690	128
11691	128
11692	128
11693	128
11694	128
11695	128

11700	125
11701	125
11704	125
11705	125
11709	125
11711	130
11713	128
11715	128
11717	132
11719	132
11721	132
11722	132
11723	132
11724	132
11725	132
11726	132
11727	132
11728	132
11729	132
11730	132
11731	132
11732	132
11733	132
11734	132
11735	132
11736	132
11737	132
11738	132
11739	132
11740	132
11741	132
11742	132
11743	132
11744	132
11746	132
11747	132
11748	132
11749	132
11750	132
11751	132
11752	132
11753	132
11754	132
11755	132
11756	132
11757	132
11758	132
11759	132
11760	132
11762	132
11763	132
11765	132
11767	132
11768	132
11770	132
11773	132
11775	132
11776	132
11778	132

11780	132
11785	132
11789	132
11790	132
11792	132
11795	132
11800	131
11801	131
118019	136
11802	131
118022	136
118024	136
118027	136
11803	131
118030	136
118075	136
11808	136
118080	136
118085	136
11809	137
11810	137
11811	137
11812	137
11815	137
11817	137
11820	137
11821	137
11822	137
11823	137
11824	136
11825	136
11826	136
11827	136
11829	136
11830	134
11831	134
11832	134
11833	134
11834	134
11835	134
11836	134
11837	134
118387	134
11839	134
11840	134
11841	134
11842	134
11843	134
11844	134
11845	134
11846	134
11847	134
11848	134
11849	134
11850	134
11851	134
11852	134
11853	134
11854	134

11855	134
11856	134
11857	134
11858	134
11859	134
11860	134
11861	134
11862	134
11863	134
11864	134
11865	134
11866	134
11867	134
11868	134
11869	134
11870	134
11871	134
11872	134
11873	134
11874	134
11881	133
11883	133
11885	133
11886	133
11887	133
11889	133
11890	133
11891	133
11892	133
118928	136
11893	133
11894	133
11895	133
11896	133
11897	133
11898	133
11899	133
11900	133
11901	133
11902	133
11903	133
119032	136
11904	133
11905	133
11906	133
11907	133
11908	133
11909	133
11910	133
11911	133
11912	133
11913	133
11914	133
11915	133
11916	133
11917	133
11918	133
11919	133
11920	133

11921	133
11922	133
11923	133
11924	133
11925	133
11926	133
11927	133
11928	133
11929	133
11950	135
11951	135
11952	135
11953	135
11954	135
11955	135
11956	135
11957	135
11958	135
11959	135
11960	135
11961	135
11962	135
11963	135
11964	135
11965	135
11966	135
11967	135
11968	135
11969	135
11970	135
11971	135
11972	135
11973	135
11974	135
11975	135
11976	135
11977	135
11978	135
11979	135
11980	135
11981	135
11982	135
11983	135
11984	135
11985	135
11986	135
12004	255
12006	255
12009	256
12114	186
12135	186
12262	187
12265	187
12270	187
12404	186
12404-1	186
12406	186
12410	186

# Numerical Index

12416	186
12420	75
12420	186
12601	258
13421	75
13422	75
13423	75
13424	75
13425	75
13426	75
13427	75
13428	75
13429	75
13504	68
13505	68
13506	68
13507	68
13508	68
13510	68
13512	68
13514	68
13516	68
13518	68
13520	68
13522	68
136573	258
13668	74
13669	74
13670	75
13671	75
13672	75
13673	75
13674	75
13675	75
13676	75
13677	75
13678	75
13679	75
13680	74
13681	74
13682	74
13683	74
13684	74
13685	74
13686	74
13687	74
136878	258
13688	74
13689	74
13700	170
13701	170
13702	170
13703	170
13704	170
13706	170
13708	170

13710	170
13712	170
13713	170
13714	170
13715	170
13716	170
13717	170
13718	170
13719	170
13720	170
13722	170
13723	170
13724	170
13725	170
13726	170
13728	170
13730	170
13732	170
13735	170
13736	170
13737	170
13738	170
13739	170
13740	170
137408	258
13741	170
13742	170
13743	170
13745	171
13746	171
13747	171
13748	171
13749	171
13750	171
13751	171
13752	171
13753	171
13754	171
13755	171
13756	171
13757	171
13758	171
13759	171
13760	171
13761	171
13762	171
13763	171
13764	171
13765	171
13766	171
13767	171
13768	171
13769	171
13770	171
13771	171
13772	171

13773	171
13775	171
13776	171
13777	171
13778	171
13779	171
13780	171
13781	171
13782	171
13783	171
13784	171
13788	172
13790	172
13792	172
14090	176
14091	176
14092	176
14093	176
14094	176
14095	176
15010	176
15011	176
15012	176
15013	176
15020	176
15022	176
15025	176
15026	176
15028	176
15029	176
15030	176
15044	177
15052	158
15060	177
15061	177
15062	177
15063	177
15070	177
15070A	177
15070N	177
15070R	177
15100	188
15100J	188
15102	188
15102J	188
15104	188
15104J	188
15106	188
15106J	188
15108	188
15110	236
15115	236
15120	158
15122	158
15124	158
15126	158

15128	158
15130	158
15132	158
15134	158
15136	158
15138	158
15230	248
15232	248
155TK	29
15610	154
15612	154
15614	154
15616	155
15625	155
15860	104
15862	104
15864	104
16240	164
16245	164
16250	165
16300	162
16302	162
16305	162
16306	162
16310	163
16311	163
16312	163
16313	163
16314	163
16315	163
16316	163
16319	163
16321	163
16323	163
16325	163
16326	163
16327	163
16340	163
16341	163
16342	163
16343	163
16344	163
16345	163
16347	163
16348	163
16349	163
16350	163
16351	163
16352	163
16360	163
16361	163
16362	163
16363	163
16364	163
16365	163
16366	163

16367	163
16370	163
16371	163
16372	163
16373	163
16374	163
16375	163
16376	163
16377	163
16390	165
17018	152
17019	152
17024	152
17026	153
17027	153
17031	153
17033	153
17036	153
17037	153
17038	153
17040	154
17044	154
17046	154
17100	152
17105	152
17150	149
17250	188
17251	188
17252	188
17255	187
17350	144
17350H	144
17351	144
17351H	144
17352	144
17352H	144
17360	144
17360H	144
17361	144
17361H	144
17370	144
17370H	145
17371	144
17371H	145
17372	144
17372H	145
17373	145
17380	147
17385	147
17386	147
17387	147
17388	147
17391	144
17400	146
17401	146
17402	146
17403	146
17404	146
17405	147

17450	148
17451	148
17470	148
17500	147
17501	147
17502	147
17503	147
17504	147
17505	147
17511	148
17520	148
17550	148
17600	148
17601	149
17602	149
17610	145
17612	145
17614	145
17616	145
17650	150
17651	150
17652	150
17653	150
17654	150
17655	150
17656	150
17657	150
17658	150
17659	150
17670	151
17671	151
17672	151
17673	151
17674	151
17690	151
17691	151
17692	151
17693	151
17694	151
19009	173
19011	164
19013	184
19015	184
19344	85
19384	86
19385	86
19386	86
19387	86
19639	227
19809	106
19810	106
19827	104
19828	104
19829	105
19830	105
19835	105
19836	105
19837	105
19838	105

19839	105
19840	105
19841	105
19842	105
19843	105
19844	105
19845	105
19846	105
19847	105
19848	105
19849	105
19850	105
19851	105
19852	105
19853	105
19854	105
19855	105
19856	105
19857	105
19858	105
19858	105
19859	105
19860	105
19876	106
19877	106
19878	106
19879	106
19880	106
19881	106
19882	106
19883	106
19884	106
19885	106
19886	106
19887	106
19888	106
19889	106
19890	106
19891	106
19892	106
19893	106
19894	106
19895	106
19896	106
19897	106
19898	106
19900	106
19901	106
19902	106
19903	106
19905	106
19906	106
19908	106
19911	106
19913	106
19914	106
19916	106
19918	106
19921	106

19955	106
19957	106
19960	106
19965	106
19970	106
19975	106
19980	106
19985	106
19990	105
19991	105
30203	223
30300	104
30302	105
30303	105
30304	105
40024	238
40026	238
40030	193
40032	193
40034	193
40038	193
40040	193
50170	190
50171	190
50175	192
50176	192
50178	192
80000	38
80002	39
80004	39
80005	38
80010	38
80020	39
80025	39
80028	40
80070	40
80080	43
80082	43
80084	42
80086	42
80094	41
80100	42
80105	42
80106	41
80121	41
80135	40
80135A	41
80155	44
80160	43
80196	43
80400	44
80402	44
80404	44
80406	44
80408	45
80410	45
80414	45
80420	45



# Numerical Index

80430	46
80434	40
80436	46
80500	46
80610	46
80702	47
80704	46
80706	47
80708	47
80710	47
80712	47
80800D	37
80800D-1	37
80800D-10	36
80800D-2	36
80800D-3	36
80800D-4	36
80800D-5	37
80800D-6	37
90000	48
90100	109
90101	109
90102	109
90103	109
90104	109
90105	109
90106	109
90107	109
90108	109
90109	109
90110	109
90111	109
90112	109
90112	109
90114	109
90115	109
90116	109
90117	109
90118	109
90119	109
90500	48
91017	108
91019	108
91022	108
91024	108
91027	108
91030	108
91032	108
91036	108
91041	108
91046	108
91050	108
91055	108
91060	108
91065	108
91070	108

91075	108
91080	108
91080	108
91085	108
91095	108
91100	108
91105	108
91110	108
91115	108
91120	108
91125	108
91130	108
91135	108
91140	108
91145	108
91150	108
91155	108
91160	108
A10052R	56
A10053R	57
A10059R	56
A10065R	56
A12100	53
A12102	54
A12107B	54
A12111B	54
A12115	54
A12170	55
A12171	55
A12180	57
A12182	57
A13027	158
A13028	158
A13029	158
A13030	158
A13031	158
A13032	158
A13033	158
A13035	158
A13036	158
A13037	158
A13044	159
A13045	159
A13046	159
A13047	159
A13060	166
A13070	167
A13071	168
A13072	168
A13073	168
A13074	168
A13075	168
A13076	168
A13078	168
A13079	168
A13080	167

A130801	168
A130802	168
A130803	168
A130804	168
A130805	168
A130806	168
A130807	168
A130808	168
A130809	168
A13082	167
A130821	168
A130822	168
A130823	168
A130824	168
A130825	168
A130826	168
A130827	168
A130828	168
A130829	168
A13084	167
A130841	168
A130842	168
A130843	168
A130844	168
A130845	168
A130846	168
A130847	168
A130848	168
A130849	168
A13140	95
A13145	95
A13150	100
A131500	100
A131501	100
A131502	100
A131503	100
A131504	100
A131505	100
A131506	100
A131507	100
A131508	100
A131509	100
A13151	100
A131510	100
A131511	100
A13152	100
A13153	100
A13154	100
A13155	100
A13156	100
A13157	100
A13158	94
A13160	94
A13161	100
A13162	100
A13163	100

A13164	100
A13165	100
A13166	100
A13167	94
A13170	72
A13173	72
A13220	102
A13225	62
A13258	66
A13285	95
A13290	95
A13315	66
A13316	66
A13328	92
A13330	71
A13334	91
A13336	91
A13337	91
A13338	90
A13339	90
A13340	92
A13342	91
A13344	92
A13355	62
A13356	62
A13362	79
A13363	79
A13365	79
A13366	83
A13367	83
A13377	78
A13378	70
A13379	76
A13390	169
A13395	169
A13400	101
A13402	101
A13404	101
A13406	101
A13408	101
A13411	101
A13413	101
A13415	101
A13428	101
A13429	101
A13430	101
A13433	101
A13434	101
A13435	101
A13437	101
A13439	101
A13441	101
A13467	101
A13469	101
A13472	101
A13474	101

A13479	101
A13480	101
A13494	101
A13495	101
A13496	101
A13497	101
A13498	101
A13499	101
A13500	90
A13501	90
A13502	90
A13510	96
A13511	96
A13512	96
A13513	96
A13514	96
A13515	96
A13516	96
A13520	96
A13521	96
A13522	96
A13523	96
A13524	96
A13525	96
A13526	96
A13527	96
A13528	96
A13529	96
A13536	95
A13537	96
A13541	95
A13542	96
A13550	93
A13551	99
A13552	99
A13553	99
A13554	99
A13555	99
A13556	99
A13557	99
A13558	99
A13560	93
A13561	99
A13562	99
A13563	99
A13564	99
A13565	99
A13566	99
A13567	99
A13568	99
A13569	99
A135706	102
A135716	102
A135726	102
A135736	102
A135746	102
A135756	102
A13576	99
A13577	99

A13578	99
A135806	102
A135816	102
A135826	102
A135836	102
A135846	102
A135856	102
A13600	93
A13608	98
A13609	98
A13610	98
A13611	98
A13612	98
A13613	98
A13614	98
A13615	98
A13616	98
A13617	98
A13618	98
A13619	98
A13694	72
A13695	72
A13700	92
A13708	98
A13709	98
A13710	98
A13711	98
A13712	98
A13713	98
A13714	98
A13715	98
A13716	98
A13717	98
A13718	98
A13719	98
A13750	93
A13751	98
A13752	98
A13753	98
A13754	98
A13755	98
A13756	98
A13757	98
A13758	98
A13760	93
A13780	94
A13781	99
A13782	99
A13783	99
A13784	99
A13785	99
A13786	99
A13787	99
A13790	94
A13791	100
A13792	100
A13793	100
A13794	100
A13795	100

A13796	100
A13797	100
A13798	74
A13799	74
A13800	74
A13801	74
A13802	74
A13803	74
A13804	74
A13805	74
A13806	74
A13807	74
A13808	73
A13809	73
A13810	73
A13811	73
A13812	73
A13813	73
A13814	73
A13815	73
A13816	73
A13817	73
A13818	73
A13819	73
A13821	73
A13822	73
A14323	69
A14330	67
A14331	67
A14332	67
A14333	67
A14334	67
A14335	67
A14336	67
A14337	67
A14338	67
A14339	67
A14340	67
A14346	66
A14347	66
A14348	66
A14349	66
A14350	66
A14351	66
A14352	66
A14353	66
A14354	66
A14355	66
A14356	66
A14357	66
A14358	66
A14359	66
A14360	66
A14361	66
A14362	66
A14401	64
A14402	64
A14403	64

A14404	64
A14405	64
A14406	64
A14410	63
A14410-5	63
A14411	63
A14411-5	63
A14412	63
A14412-5	63
A14413	63
A14414	63
A14415	63
A14420	63
A14421	63
A14422	63
A14423	63
A14424	63
A14425	63
A14426	63
A14427	63
A14428	63
A14429	63
A14430	63
A14431	63
A14432	63
A14435	67
A14435	67
A14436	67
A14437	67
A14438	67
A14439	67
A14440	67
A14441	67
A14442	67
A14448	67
A14449	67
A14450	67
A14451	67
A14452	67
A14453	67
A14454	67
A14455	67
A14456	67
A14457	67
A14458	67
A14459	67
A14460	67
A14461	67
A14462	67
A14465	63
A14466	63
A14467	63
A14468	63
A14469	63
A14470	63
A14471	63
A14472	63
A14475	63

# Numerical Index

A14476	63
A14477	63
A14478	63
A14479	63
A14480	63
A14481	63
A14482	63
A14483	63
A14484	63
A14721	64
A15002	257
A22000	51
A22001	51
A22002	51
A22104	50
A22105	51
A22110	53
A22112	53
A22114	50
A22150	50
A7100	178
A7200	178
A7201	180
A7202	180
A7203	180
A7204	180
A7205	180
A7206	180
A7207	180
A7208	180
A7210	178
A7211	180
A7212	180
A7213	180
A7214	180
A7215	180
A7216	180
A7217	180
A7220	179
A7221	180
A7222	180
A7223	180
A7224	180
A7225	180
A7229	181
A7230	179
A7233	180
A7234	180
A7235	180
A7240	179
A7241	180
A7242	180
A7243	180
A7244	180
A7245	180
A7246	180

A7250	179
A7251	181
A7252	181
A7253	181
A7254	181
A7255	181
A7256	181
A7260	178
A92002	109
A92003	109
A92004	109
A92005	109
A92010	109
A92015	109
A92020	109
A92025	109
A92030	109
A92035	109
A92040	109
A92045	109
A92050	109
A92055	109
A92060	109
A92065	109
A92070	109
A92075	109
A92076	109
A92080	109
A92081	109
A92085	109
A92090	109
A92095	109
A92100	109
A92105	109
A92110	109
A92115	109
A92120	109
A92125	109
A92130	109
A92135	109
A92140	109
A92145	109
A92146	109
A92150	109
A92151	109
A92152	109
A92155	109
AC10	97
AC12	97
AC14	97
AC16	97
AC18	97
AC20	97
AC22	97
AC24	97
AC26	97

AC28	97
AC30	97
AC32	97
AC34	97
AC36	97
AC40	97
AC42	97
AC44	97
AC46	97
AC48	97
AC50	97
AC52	97
AC54	97
AC56	97
AC8	97
ACM07TS	97
ACM08TS	97
ACM09TS	97
ACM10TS	97
ACM11TS	97
ACM12TS	97
ACM13TS	97
ACM14TS	97
ACM15TS	97
ACM16TS	97
ACM17TS	97
ACM18TS	97
ACM19TS	97
ACM20TS	97
ACM21TS	97
ACM22	97
ACM23	97
ACM24	97
ACM25	97
ACM26	97
ACM27	97
ACM30	97
ACM32	97
ACM36	97
ACM41	97
ACM42	97
ACM43	97
ACM44	97
ACM46	97
ACM48	97
ACM50	97
ACO-3320	282
ADG-2322	281
ADG-2322A	281
ADI-3219A	282
AH12	245
AH12B	245
AH18	84
AHC15	213
AHC30	213
AHM-1050	283

AHM-93210	284
AHM-932101	284
AHM-932102	284
AHM-932103	284
AHM-932104	284
AHM-932105	284
AHM-932106	284
AHM-932107	284
AHM-932108	284
AHM-932109	284
AHM-932110	284
AHM-932111	284
AHM-932112	284
AHM-932113	284
AHM-932114	284
AHM-932115	284
AHMK-4	284
AIR-3407	281
AIW-00404	280
AIW-10306X	278
AIW-10406X	278
AIW-10410MT	279
AIW-10410X	279
AKC110	80
AKC111	80
AKC112	80
AKC113	80
AKC114	80
AKC115	80
AKC116	80
AKC117	80
AKC118	80
AKC119	80
AKC120	80
AKC121	80
AKC122	80
AKC123	80
AKC1238	78
AKC124	80
AKC125	80
AKC127	80
AKC128	80
AKC129	80
AKC130	80
AKC131	80
AKC132	80
AKC133	80
AKC134	80
AKC135	80
AKC136	80
AKC137	80
AKC138	80
AKC139	80
AKC141	80
AKC142	80
AKC143	80

AKC144	80
AKC145	80
AKC146	80
AKC147	80
AKC148	80
AKC149	80
AKC150	80
AKC152	80
AKC153	80
AKC155	80
AKC156	80
AKC157	80
AKC161	80
AKC164	80
AKC168	80
AKC172	80
AKC177	80
AKC212	73
AKC213	73
AKC214	73
AKC215	73
AKC217	73
AKC219	73
AKC220	73
AKC222	73
AKC223	73
AKC224	73
AKC226	73
AKC227	73
AKC228	73
AKC229	73
AKC230	73
AKC239	73
AKC240	73
AKC241	73
AKC242	73
AKC243	73
AKC244	73
AKC245	73
AKC246	73
AKC247	73
AKC248	73
AKC249	73
AKC250	73
AKC251	73
AKC252	73
AKC253	73
AKC254	73
AKC255	73
AKC256	73
AKC257	73
AKC258	73
AKC259	73
AKC260	73
AKC262	73
AKC300	70
AKC302	69
AKC303	70
AKC304	70

AKC305	69
AKC326R	69
AKC328	73
AKC3812	70
AKC3814	70
AKC402	64
AKC403	65
AKC404	65
AKC405	64
AKC406	65
AKC501	84
AKC502	84
AKC504	84
AKC505	84
AKC506	84
AKC507	84
AKC508	84
AKC509	84
AKC510	84
AKC511	84
AKC512	84
AKC513	84
AKC514	84
AKC515	84
AKC516	84
AKC517	84
AKC518	84
AKC519	83
AKC520	83
AKC522	83
AKC523	83
AKC523	83
AKC524	83
AKC525	83
AKC526	83
AKC527	83
AKC528	83
AKC529	83
AKC530	83
AKC531	83
AKC532	83
AKC533	83
AKC534	83
AKC535	83
AKC536	83
AKC540	84
AKC541	84
AKC542	84
ATB-1240	282
ATK115	30
ATK158BB	7
ATK18D	20
ATK218BB	8
ATK322	11
ATK322BB	12
ATK322TB	12
ATK338BB	13
ATK409BB	14
ATK42BB	22

ATK50	30
ATK523DBB	16
ATK532RBB	18
ATK610D	10
ATK703U	28
ATK79BB	9
ATK900D	24
ATK920	25
ATK95BB	26
ATK960	27
AZDA10	77
AZDA114	65
AZDA210	77
AZDA23	77
AZDA25	77
AZDA26	78
AZDA26D	78
AZDA315	76
AZDA317	76
BG200	248
BJ10000W	242
BJ15000W	242
BJ20000W	242
BJ2000W	242
BJ4000W	242
BJ6000W	242
BJ8000W	242
BSK2-07	271
BSK3-07I	273
BSK3-07I	273
BSK3-11TT	273
BSK4-16T	275
BTHK2-8T	296
C057	251
DEWK10	296
DEWK10	296
DP1F	248
DRS1113	291
DRS1417	291
DRS1719	291
DRS1721	291
DRS1824	291
DRS1921	291
DRS1922	291
DRS2427	291
DRS2430	291
DRS2632	291
DRS2730	291
DRS2732	291
DSK2-09I	271
DSK2-12	271
DSK3-08	271
DT100	246
DTWA-135N	269
DTWA-340N	269
FJ1	242
G301	212
GC01	246

H250	268
H34	81
H47	266
H48	266
H49	268
H49	266
H50	268
H50	266
H51	268
H51	266
H52	266
H53	266
H54	266
H55	266
HAC-12I	297
HKK-9	297
HKK-9I	297
HMBP300	293
HMBP301	293
HMBP350	293
HMBP400	293
HMBP401	293
HMBP410	293
HOS32	291
HOS35	291
HOS36	291
HOS38	291
HOS41	291
HOS46	291
HOS50	291
IHK46-08M	276
IHK46-18T	276
ISK4-810M	277
ISK4-810MP	277
JS2000	242
JS4000	242
JS6000	242
KC100	81
KC1000	81
KC101	81
KC102	81
KC103	81
KC1034	84
KC104	81
KC105	81
KC106	81
KC108	82
KC1234	78
KC1410	82
KC1438	65
KC310	70
KC315	70
KC320	70
KC322	70
KC323	70
KC326	70
KC3412	82
KC406	65



# Numerical Index

KC407	65
KC800	84
LL01	244
M1000	192
M1100	191
M1150	191
M1200	191
M1300	191
M3075	191
M3200	190
M3400	190
M4025	191
M6400	191
M7150	190
M7200	190
M8080	192
NH10	76
NH11	76
NH13	76
NH14	64
NH15	64
NH16	64
NH36	69
NH37	69
NH38	69
NH40	69
NH9	76
PB01	244
PB02	244
PR13004	155
PR13006	155
PT52	253
PT52M	254
PUG0203	294
PUG0204	294
PUG0206	294
PUG0208	294
PUG0212	294
PUG0303	294
PUG0304	294
PUG0306	294
PUG0308	294
PUG12080	295
PUG12120	295
PUG12200	295
PUG2304	295
PUG2307	295
PW01	245
PW02	245
RS-05I	286
RS-06I	286
RS-07I	286
RS-08	286
RS-08I	286
RS-09	286
RS-09I	286

RS-10	286
RS-10I	286
RS-11	286
RS-11I	286
RS-12	286
RS-12I	286
RS-13	286
RS-14	286
RS-15	286
RS-16	286
RS-17	286
RS-18	286
RS-19	286
RS-21	286
RS-22	286
RS-24	286
RSK-12	288
RSK-8I	288
RSK-8I	288
RSL-0810	289
RSL-1012	289
RSL-1214	289
RSL-1315	289
RSL-1417	289
RSL-1618	289
RSL-1719	289
RSL-2224	289
RSLD-08	287
RSLD-09	287
RSLD-10	287
RSLD-11	287
RSLD-12	287
RSLD-13	287
RSLD-14	287
RSLD-15	287
RSLD-16	287
RSLD-17	287
RSLD-18	287
RSLD-19	287
RSLDK-8	289
RSLDK-9I	289
RSLK4	290
RSMK-4	292
RSMK-4	290
RSR-08	287
RSR-09	287
RSR-10	287
RSR-11	287
RSR-12	287
RSR-13	287
RSR-14	287
RSR-15	287
RSR-16	287
RSR-17	287
RSR-18	287
RSR-19	287

RSRK-12	289
RSS-08	286
RSS-09	286
RSS-10	286
RSS-11	286
RSS-12	286
RSS-13	286
RSS-14	286
RSS-15	286
RSS-16	286
RSS-17	286
RSS-18	286
RSS-19	286
SA0101S	212
SA12	212
SA14	212
SA225	212
SA250	212
SA325	212
SA350	212
SA38	212
SB10G	246
SB10GN	246
SB2021-1	212
SB2031-1	212
SB2041-1	212
SBC03	246
SD13	172
SDDK3-10I	272
SDDK3-12	272
SDDK4-12	274
SDHK2-11I	271
SDHK3-12	272
SDHK4-12	274
SDVK-7	296
SG0101R	207
SG0204PSR	207
SG0315	210
SG0420	204
SG0430	205
SG0516	209
SG0519	204
SG0692	209
SG0719	201
SG0720	201
SG0735	202
SG0750	198
SG0750L	199
SG0756	199
SG0810	208
SG0814	208
SG0822	210
SG1057	211
SG1068	211
SG1072	211
SG1072L	211

SG1072XL	211
SG1222	211
SG1222N	211
SG2110NS	210
SG315NS	210
SG843K	211
SG9907	210
SHAD01	260
SHAD10	261
SHAD12	262
SHAD14	262
SHAD16	263
SHAD18	262
SHAD2	261
SHAD20	263
SHAD22	263
SHAD24	261
SHAD4	260
SHAD6	260
SHAD8	261
SM015	206
SM030	198
SM030L	198
SM055	203
SM065	204
SM070	204
SM085	205
SM090	206
SM095	205
SM100	205
SM135	208
SM135BHD	208
SM135BHS	208
SM135BW	208
SM135RH	208
SM135RW	208
SM135RWW	208
SM135WW511	208
SM135WW523	208
SM135WW711	208
SM135WW723	208
SM204	209
SM213	209
SM30	201
SM31	201
SM401	196
SM403	197
SM41	196
SM41-4017G	196
SM43	196
SM43-4002	197
SM43-4037G	197
SM43-4037L	198
SM43-4134	197
SM454	199
SM45-4057G	199



# KC TOOLS®

**JOB  
DONE**

## CONTACT US:

### QLD/NT/SA

34 Granite Street  
Geebung, QLD 4034

**P:** 07 3216 2022

**F:** 07 3216 2033

**E:** sales@kctoolsqld.com.au

### VIC/TAS/WA

34 Garden Drive  
Tullamarine, VIC 3043

**P:** 03 9335 1122

**F:** 03 9338 0748

**E:** vicadmin@kctools.com.au

### New South Wales

11 Amax Avenue  
Girraween, NSW 2145

**P:** 02 9896 4933

**F:** 02 9896 4338

**E:** joe@kcnsw.com.au

### New Zealand

Wayco Equipment Ltd  
6 Tironui Road, Papakura  
Auckland 2112

**P:** 09 2962 264

**F:** 09 2962 237

**E:** wayco@xtra.co.nz

### Norway

Fosen Tools AS  
Industrigata 1, 7130 Brekstad,  
Norway

**P:** 047 7251 5120

**F:** 047 7251 5129

**E:** post@fosen-tools.no



[WWW.KCTOOLS.COM.AU](http://WWW.KCTOOLS.COM.AU)