

truMedic® INSTASHIATSU+®
Products to Live Life Better® Your Personal Masseuse

Massage Chair | MC-1000

Instruction Manual



MC-1000 Massage Chair Operation Manual

Experience the latest in high-tech luxury with the truMedic® InstaShiatsu+ MC-1000 Massage Chair. We've combined the benefits of an ergonomic design with a soothing full body massage to give you a spa experience in the comfort of your own home. The MC-1000 Massage Chair includes the following features:

- **Several Massage Techniques:** A combination of kneading, shiatsu, pressing, knocking, and tapping sensations bring relief to every area of your body.
- **Acupressure Functionality:** This massage function targets pressure points throughout your body to relieve tension and ease stress.
- **Custom Adjustment Capabilities:** Shift the seat, backrest, and leg rest in increments to find the perfect position or relax in a zero gravity position and experience the feeling of weightlessness. The custom adjustment function caters to your individual preference.
- **Forward sliding functionality:** Move the seat 4 inches from the wall before starting your massage session. This allows you to store your massage chair in a more compact space without sacrificing the ability to enjoy a full body massage.
- **Rolling and Pressurized Foot Massage Functionality:** Initiate a foot massage that will provide relief to your whole body by targeting specific pressure points throughout your feet.
- **Proprietary Airbag Pressure-Massage Functionality:** Strategically located airbags grip, twist, and gently stretch your muscles. Sit back and relax as airbags in the seat provide additional relief to your waist and hips.
- **Custom Height Adjustment Capabilities:** The leg rests extend and retract within a range of 8 inches to accommodate users of all heights.
- **High-Quality Remote Control:** The MC-1000 uses a variable frequency drive LCD remote control that features a new, cutting-edge design.

TABLE OF CONTENTS

Before Using the MC-1000 Massage Chair	1
Warnings and Notes of Caution	2
Getting to Know the Parts of Your Chair	6
Installation Guide	11
Adjusting Your MC-1000 Massage Chair	16
MC-1000 Remote Control Usage Guide	19
Operating Your MC-1000 Massage Chair	24
Cleaning and Maintaining the MC-1000	28
Troubleshooting the MC-1000	30
Technical Specifications	32

A Quick Note from truMedic®

As you install and begin to use your new massage chair, keep the following recommendations in mind:

- Read the operation manual in full before you attempt to install or use your massage chair.
- Store your operation manual in a convenient place for quick reference.
- Carefully read all warnings and cautionary notes provided in your manual.

truMedic® reserves the right to change the design specifications of the MC-1000 without notice. Use the images provided here as a guide and not an exact replica of your chair. Always refer to your massage chair as you read through the instructions.

1 SAFETY INSTRUCTIONS

Before Using the MC-1000 Massage Chair

Please note all symbols and signs outlined in this operation manual and follow the instructions listed for an effective and safe operating experience. Throughout this manual, we will use several symbols to indicate important areas:

	<p><i>If you see this symbol, the accompanying language will describe a warning for serious bodily injury or death.</i></p>		<p><i>The caution symbol denotes something that may cause an injury or property damage.</i></p>
	<p><i>Avoid engaging in the listed behaviors associated with this symbol.</i></p>		<p><i>Do not disassemble any part on your chair featuring this symbol. Doing so may increase the risk of harm or void any accompanying warranty.</i></p>
	<p><i>You must adhere to these guidelines when operating your new massage chair.</i></p>		<p><i>This symbol will provide directions on how to use a particular cable during assembly and use.</i></p>
	<p><i>This chair is not waterproof, avoid contact with any liquids.</i></p>		<p><i>This symbol denotes any fire or environmental hazards.</i></p>

Warnings and Notes of Caution



WARNING

People Who Should Not Use the MC-1000

- Those with osteoporosis.
- Those who have a pacemaker implant or other electrical medical implant.
- Those who are pregnant or in poor health should discuss use with a physician.
- Children under the age of 12.
- Anyone under the influence of alcohol or recreational drugs.
- Anyone who may fall asleep while using the chair (this chair is not meant for sleeping).

Accident and injury warnings

- Do not allow children, pets, or any objects in or around the chair while it is in an adjusted position or in operation.
- Immediately discontinue use and speak with a medical professional if you experience any strange symptoms while using your massage chair.
- Do not sleep in the chair.
- Do not sit or stand on the armrests.
- Avoid excessively targeting any one area of the body to reduce the risk of injury.
- Closely monitor any user who suffers from mobility difficulties.

Fire and electrocution warnings

- Always insert the plug into an appropriate power outlet.
- Never leave a plug sticking partly out of an outlet.
- Always turn off and unplug the chair when it is not in use.

Fire and electrocution avoidance

- Do not use a plug, cord, or outlet if you identify a poor or broken contact.
- Only use power sources that support the recommended voltage to reduce the risk of fire or electric shock.
- Do not use any damaged, twisted, knotted, or constricted power cords.

Accident avoidance

- Do not fold massage chair cushions if you plan to store the chair.
- Do not run this massage chair for long, uninterrupted periods. Follow all run-time recommendations listed in this manual.



WARNING (CONT.)



Notes on User disassembly and Maintenance

- Contact a professional if your chair experiences water damage or begins to function improperly. Do not modify, disassemble, or perform unspecified maintenance.
- Do not attempt to repair or replace a damaged power cord or plug. Contact the service team at truMedic® or a professional dealer to receive a replacement.
- Do not remove or open any part of the chair for any reason.
- Contact a professional for repair if you notice any irregularities or damage in the cloth and leather coverings on your massage chair.



CAUTION



Avoiding Falls

- Always operate your chair on a flat and even surface.

Preventing Wall and Chair Damage

- Always place the chair at least 4 inches from all walls to allow for proper positioning.

Avoiding Injuries Associated With Excessive Use

- The maximum recommended massage time is 20 minutes. Try to change massage settings and positions every 5 minutes for best results. Failing to change positions frequently could result in discomfort.

Avoiding Accidents and Injuries

- Check the power switch before plugging the massage chair into the outlet. The power switch should sit in the OFF position any time you unplug or plug in the chair.
- Fully insert the plug into the outlet before turning the chair ON.
- Turn off all controls and switches before unplugging the chair.

Avoiding Electrocutation

- Look for cord and wire damage before using the massage chair.
- Follow all instructions for proper ground wire connectivity. The wire should not have any irregularities.



Avoiding Accidents and Injuries

- Do not press into or step on the massage heads.
- Do not place your hands or feet in between gaps in the massage heads.
- Do not put your hands or feet in between spaces in mechanical components.
- Do not drop or purposefully insert objects into the massage chair slot.
- Do not sit, stand, or place heavy objects on chair components, including the armrests, leg rests, and backrests.
- Never stand on the chair.
- Do not attempt to move a chair while it's operating.
- Do not use massage areas for unintended body parts (e.g., do not put your head in the leg rest).
- Do not put unusual amounts of pressure on the backrest while the chair is reclined.
- Avoid using the chair with exposed skin or while wearing sheer fabrics. Using the chair with improper clothing could lead to skin irritation.
- Empty your pockets before sitting in the chair.



Avoiding Chair Damage, Discoloration, and Deterioration

- Do not place the chair in humid or wet environments, around sharp things, or near heat sources, including stoves.
- Never use an electric heating pad, blanket, or other heated device while using the chair.
- Do not use the chair in high-temperature areas.
- Do not use the chair in an outdoor environment.



Avoiding Leaks and The Potential for Electrocutation Injuries

- Do not use or store your chair in a wet, humid, or exposed environment such as a swimming pool area or bathroom.
- Both the chair and the accompanying remote control must remain dry at all times.
- Do not sit in the chair with wet or damp clothes.



Avoiding electrocutation Injuries

- Follow all directions for installing the ground wire or contact a professional electrician for assistance.
- Never use a plug adapter. Contact a professional electrician if you do not have the appropriate outlet for installation.



Avoiding Electrocutation Injuries or Fire

- Unplug the chair before cleaning.
- Unplug the chair if you notice any power damage or the potential for power-related damage (i.e., during thunderstorms).
- To unplug the chair, firmly grasp the plug (not the cord) to release the prongs from the outlet.



CAUTION (CONT.)



Avoid accidents:

- Avoid power-related damage:
- Always turn the switch to the OFF position and unplug your chair during electrical outages.

Special Notes

Grounding Note

- This chair features a cord with a grounding conductor. Only use the appropriate outlet to power your massage chair.

Fuse Replacement Note

- If a fuse burns out in your chair, turn the switch to the OFF position and unplug the chair. Locate the switch box and identify the dysfunctional fuse. Only replace a burned out fuse with a matching fuse. Contact a professional electrician for further assistance if needed.

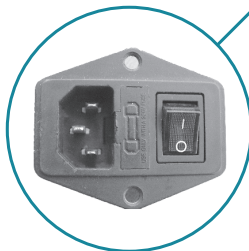
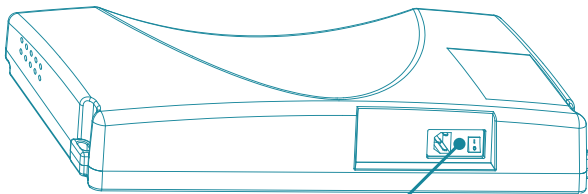

Fuse Location



Ground Wire Placement Warning

Do not place the ground wire near a gas pipe, phone wire, lightning rod, or water pipe. These areas present high risks for fire, electric shock, and damage.

Getting to Know the Parts of Your Chair

Take the time to review the graphics available in this section and familiarize yourself with the distinctive parts of your new massage chair. Throughout this operation manual, you will notice that we use these terms to help you through the installation process. We have outlined the exterior and interior parts you will need to know to install and maintain your chair.

As soon as you unbox your massage chair, use the components listing to verify that you have all necessary parts. Contact truMedic® at service@truMedic.com if you are missing any pieces.

External Structure

1. Remote Control
2. Right Armrest
3. Seat Cushion
4. Leg Rest
5. Footrest
6. Head Padding
7. Back Padding
8. Shoulder Massager
9. Left Armrest
10. LED Light
11. Castor



External Structure (Cont.)

1. Backrest
2. Power Case
3. Power Cord Socket
4. Fuse Socket
5. Power Switch

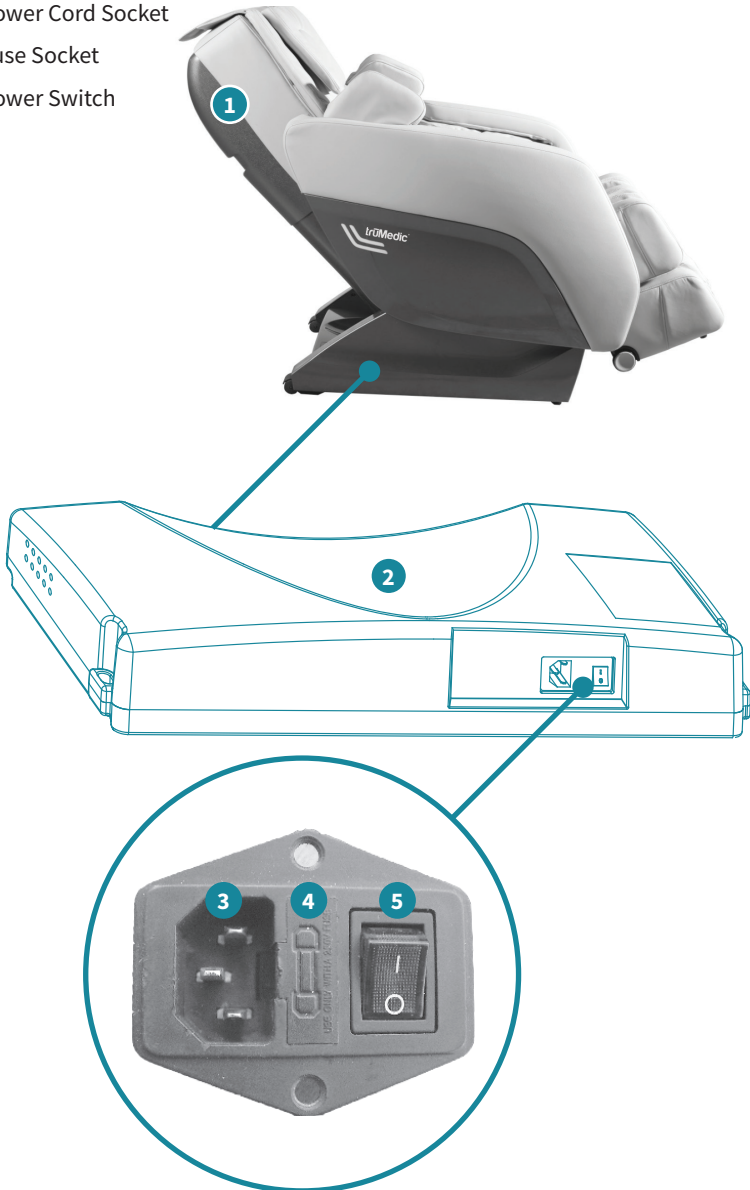

Internal Structure

1. Massage Heads (Under Cushion)
2. Shoulder Airbags
3. Lower Back Airbags
4. Armrest Airbags
5. Side Seat Airbags
6. Leg Airbags
7. Calf Airbags
8. Foot Airbags
9. Shiatsu Foot Rollers

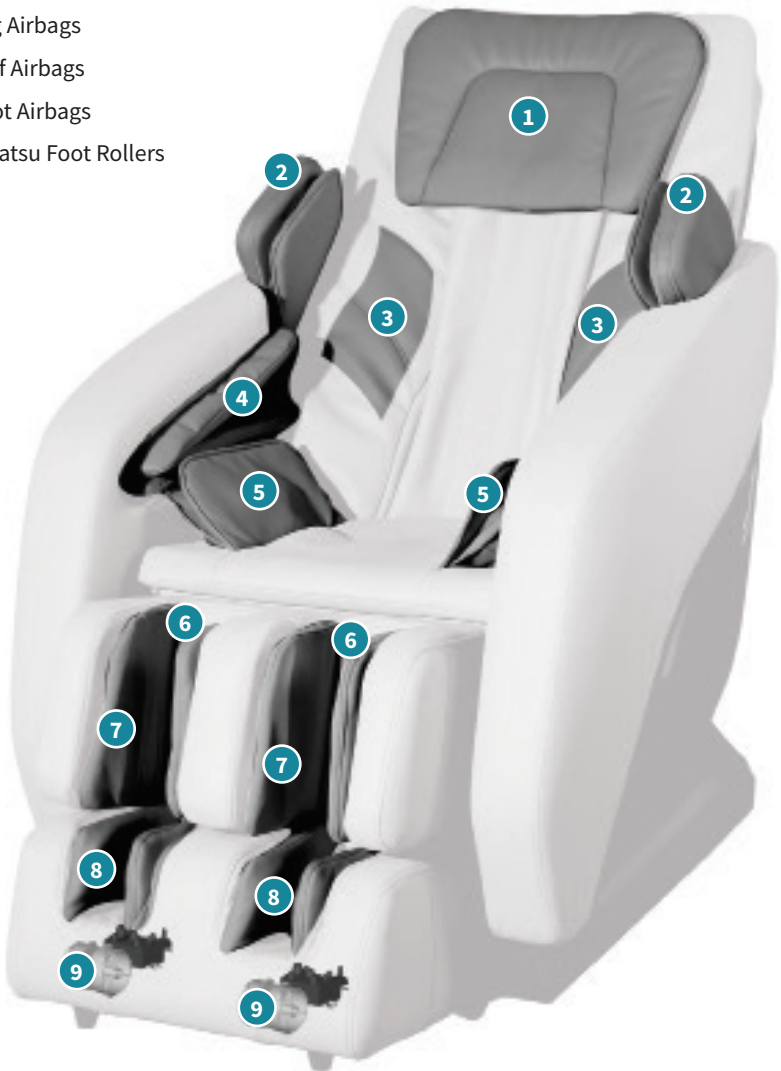

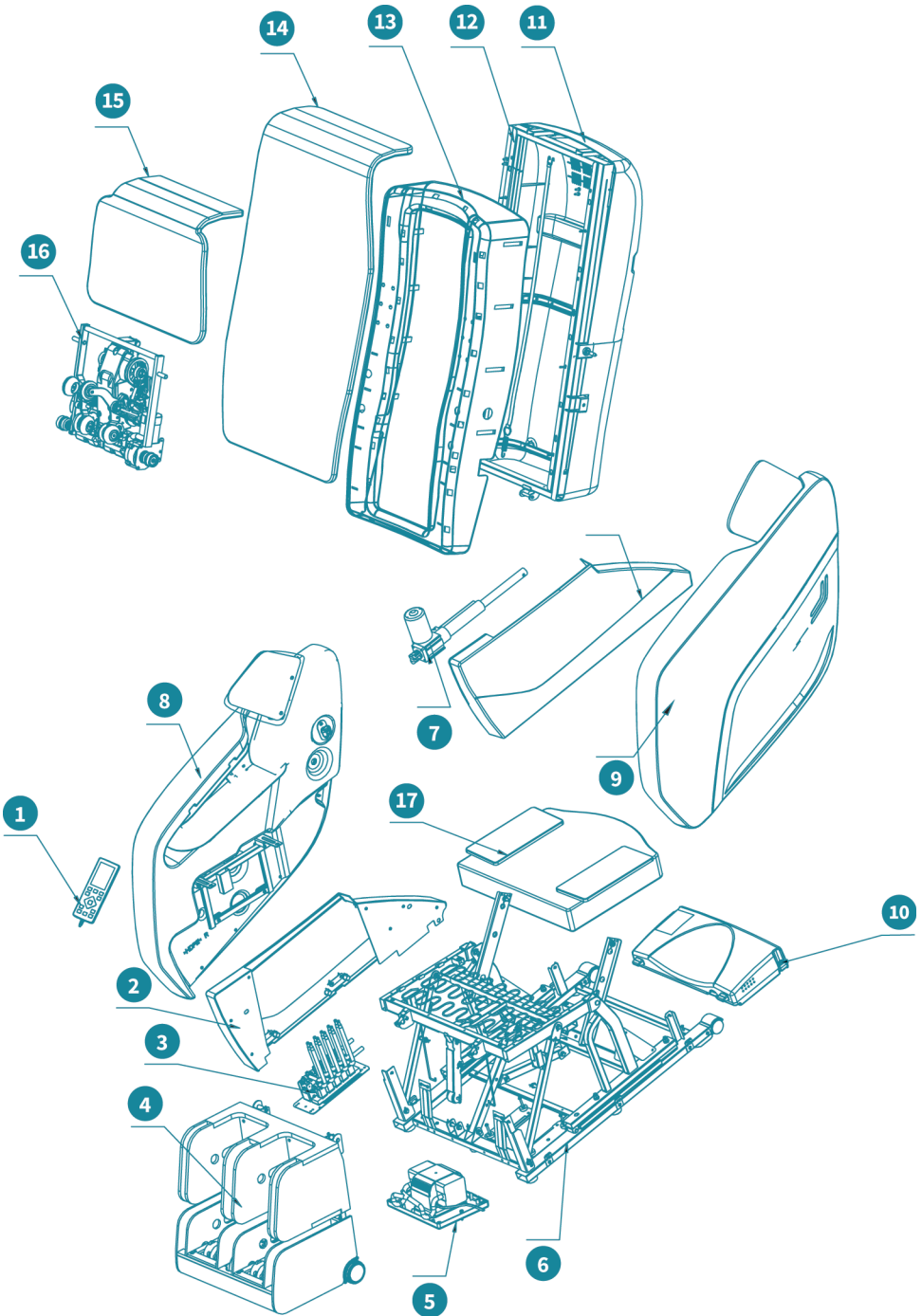

Mechanical Components List

#	Name	Qty
1.	Remote Control	1
2.	Right Side Fender	1
3.	Electric Magnetic Valve	1
4.	Leg Rest & Footrest	1
5.	Air Pump Case	1
6.	Seat Frame	1
7.	Electric Actuator	1
8.	Left Side Fender	1
9.	Left Armrest Assembly	1
10.	Power Case Assembly	1
11.	Back Cover Assembly	1
12.	Back Frame Assembly	1
13.	Plastic Front Cover	1
14.	Back Cushion	1
15.	Pillow	1
16.	Massage Machine	1
17.	Seat Cushion	1
18.	Right Armrest Assembly	1

Installation Guide

You now have all the knowledge you need to start assembling your new massage chair. This section features a step-by-step guide to unboxing and setting up your chair. Follow the instructions closely, as this product contains several important components.

1. Unbox the Chair:

- A. Ask someone to help you lift the main body of the chair out of the box. Grab the metal frame on the left and right sides of the body and lift. Set the main body of the chair aside as you unbox the remaining pieces. Remove the head pad, back cushion, seat cushion, and power cord.
- B. **NOTE:** Keep the foam piece located between the backrest and seat in place during this part of the installation, removing it could scratch the leather.

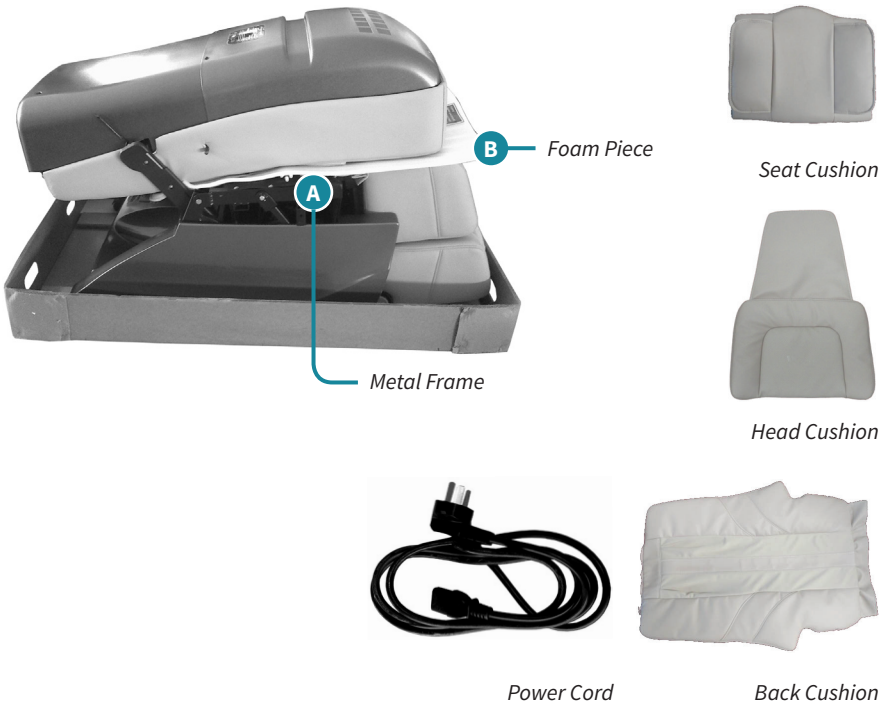

- C. Remove the armrests from their box. Each one is positioned upside down. Grab each armrest with one hand on each side and lift gently. Set the armrests on a flat surface for now.

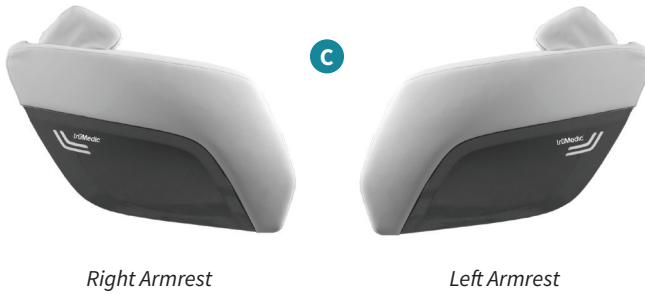

2. Position the backrest:

- D. Lift the back of the chair up 120 degrees. You should hear a click when the backrest is in the appropriate position. Remove the foam insert before you move on to the next step.

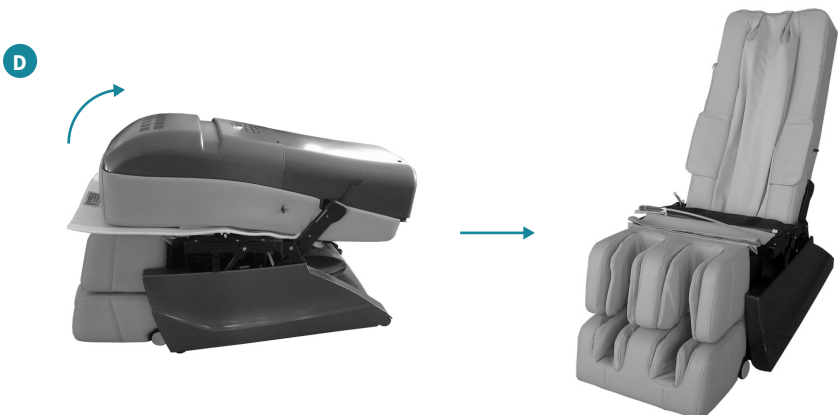

13 INSTALLATION

3. Attach the Armrests:

! Before you install the armrests, locate the remote control in the middle of the leg rest.

- E. Locate and unscrew the M6 bolts on the main seat frame using a Phillips head screwdriver. Set aside. Locate the fixed hole on the back interior of the armrest. Press the button located on the hole and insert it into the fixed bolt located on the backrest.
- F. Connect the square metal tube into the corresponding piece on the seat frame.
- G. Align the armrest with the bolt hole on the interior of the main seat frame and screw the M6 bolts you set aside into the holes. You should screw in 2 bolts for each corner (4 bolts total).
- H. Connect the armrest air hose to the main seat frame air hose and make sure the connection is secure.
- I. Connect the LED wire located on the armrest to the main seat frame LED wire.

Note: Do not compress air hoses or LED wires during assembly.

Note on Disassembly: If you need to disassemble the armrests for any reason, remove the shoulder device and the airbags located on the seat first. Then, reverse the assembly process outlined above starting with detaching the seat, air hose and LED wire.

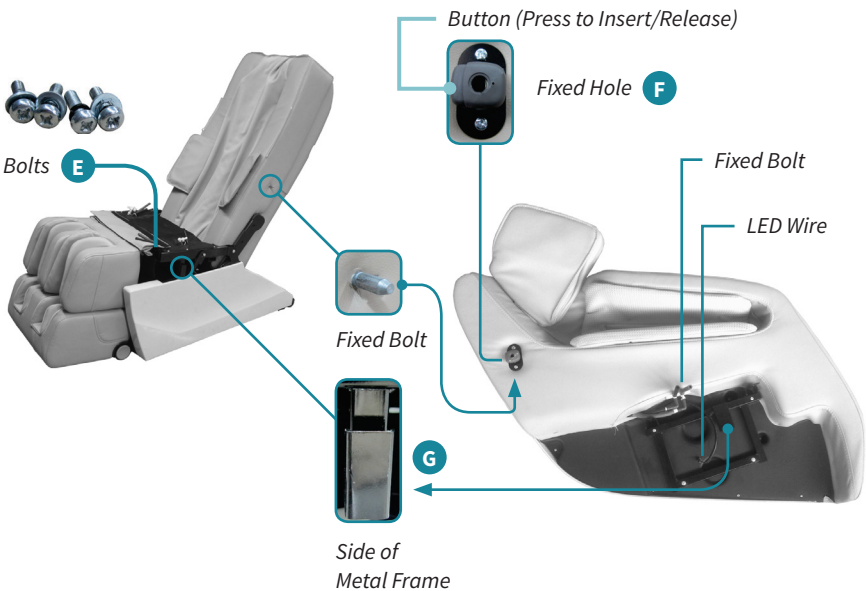

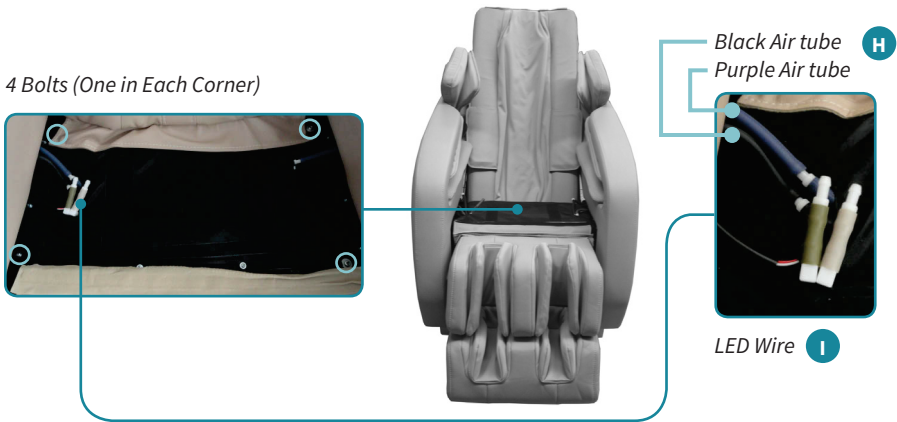

4. Attach the Head Pad and Back Cushion:

- J. The back cushion attaches to the backrest with a zipper. The head pad attaches to the backrest with Velcro.



Massage Setup Tip: Your massage chair features a body test function designed to customize massage settings to your needs. For precise measurement, sit in the chair and make sure the edge of the head pad aligns with your ears before you zipper the pad into place.

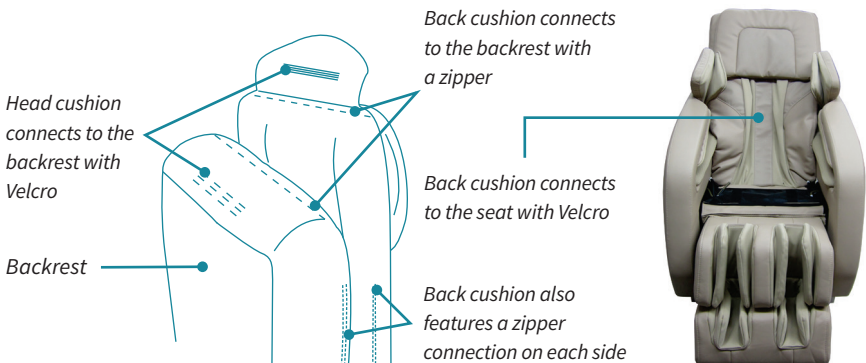

15 INSTALLATION

5. Connect Seat Air Tubes:

For the air pressure massage features, connect each color-coded air tube to the corresponding tubes on the main body of the chair. After you connect the air tubes, Velcro the seat cushion into place.

The Seat Area

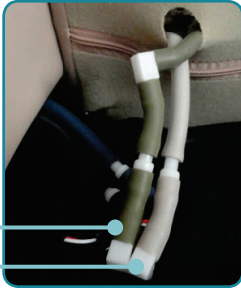

Gray Air Tube
Dark Brown Air Tube



Seat Cushion

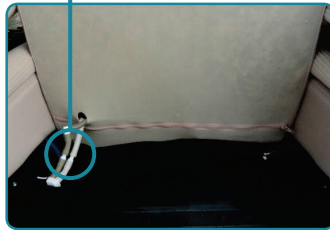

6. Turning On Your Chair for the First Time:

- Insert the power cord into hole “a,” located on the power box.
- Insert the other end of the power cord into a power source, such as an electrical outlet.
- Press the “1” switch to turn on the power to the chair.
- Grab your remote control and enjoy your first at-home luxury massage.



Always double-check the switch and make sure the power is OFF before you plug or unplug the chair from your power source.

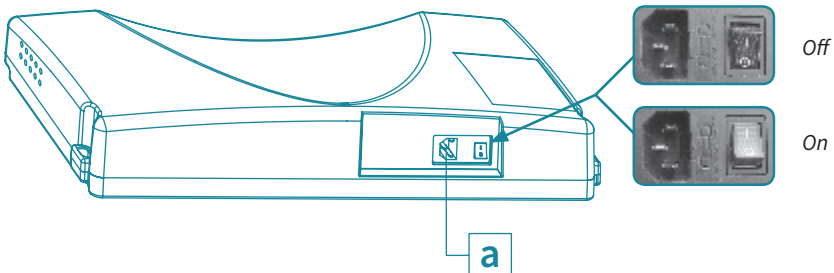

Adjusting Your MC-1000 Massage Chair



	<p>Do not place your chair near any areas that may suffer from moisture or wetness.</p>
	<p>Avoid placing your chair in direct sunlight or near heating appliances.</p>
	<p>Always place your chair on an even and supported surface to avoid accidents and injuries.</p>

Placing Your Massage Chair

What to Do Before Using Your Chair:

- Check the clearance by fully extending your chair in all directions. Make sure there are no obstacles in your way such as pets, children or side tables.
- Monitor the power plug and source. Clean the plug and cord routinely to avoid dust buildup. Make sure the plug rests comfortably and protected between the power source and the chair. The cord should never sit under a heavy object or appear to have kinks, stretching or knots.
- Place the chair away from walls. The chair should sit out at least 4 inches from the wall starting from the backrest and at least 12 inches from the front of the leg rest.



Distance from Wall (Front and Back)



Do not move your chair when the power is ON or the chair is plugged in.

Tips for moving your massage chair

Moving Your Chair to the Right Place Easily and Successfully

- Wrap and place all cables in the seat of your chair to keep them out of the way and free from damage.
- Avoid trying to plump up the cushions of the chair during use or when you try to move it.
- Do not slide the chair on its castors it may damage the floor. Instead, ask someone to help you lift or move it.
- Keep the power off and the plug/power cord away from the floor until you are ready to plug the chair back into an outlet. Leave the chair standing in a safe position to prevent the back from falling to the floor.



Movement Examples

- Example: One person can lift up from behind the leg rest until the chair falls onto its castor. Once in position, the individual may push the chair to a new position and set it back down. Never allow the chair to fall down to the floor on the backrest, as this may result in damage. Use the diagram above as an example of how you should move the chair.

Helpful Tip

To protect your floors, consider placing a mat or rug under the chair before moving it to a new location.

Adjusting Your Chair for Maximum Relaxation

Improving Your Massaging Experience

- Check the placement of the massage head to keep it from hitting you in the head during use.
- If the massage head cannot accurately detect your position during the test sequence, the chair will revert to and use its default settings in the middle position.
- In the correct position, your head should comfortably rest on the pillow and your back should rest easily against the backrest. During the test cycle, the massage roller will move around and adjust to your body. When the acupressure tracking system finishes its detection test cycle, it will beep. From there, you may adjust the seat manually according to your preference.







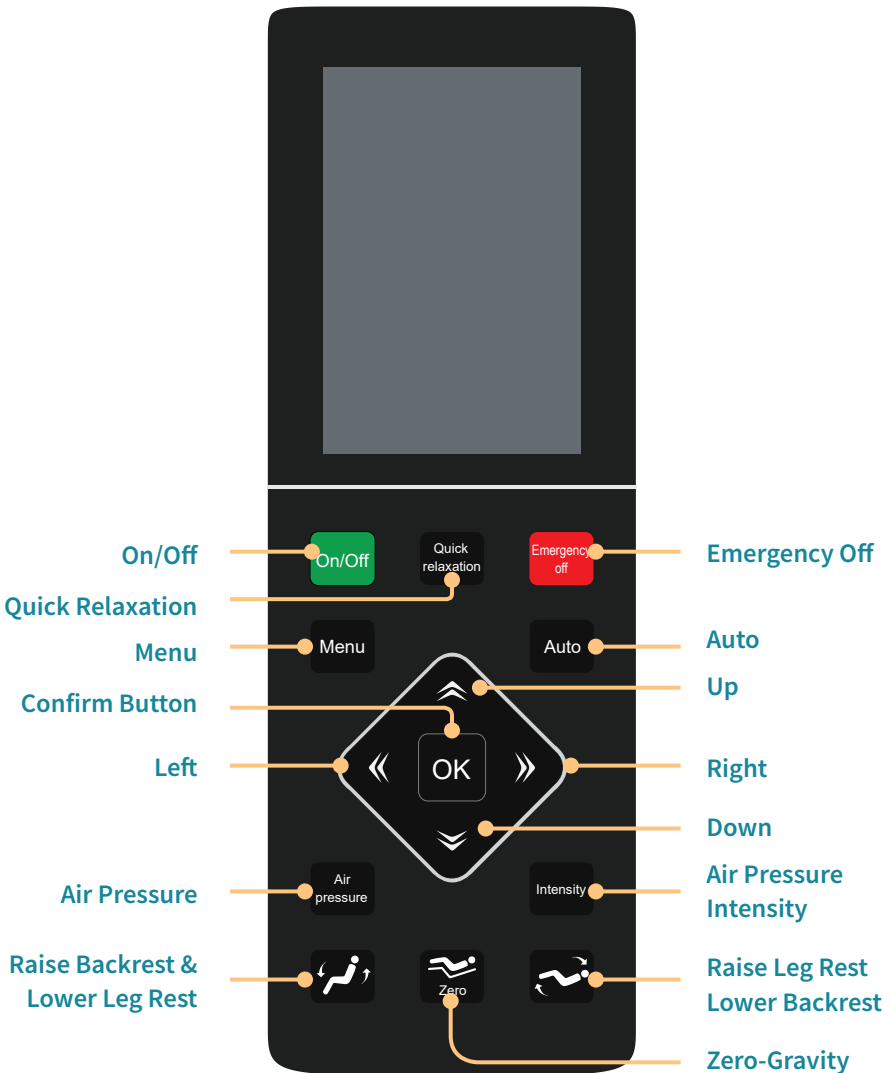

If needed, you may remove the pillow or cushion to increase the intensity level of the massage and improve your results.



MC-1000 Remote Control Usage Guide

The remote control that comes with your MC-1000 massage chair features a user-friendly interface and a colorful and crisp LCD screen. To help you learn the numerous functions available through your new massage chair, we've compiled this helpful guide. Return to this section as needed to learn more about the many ways you can customize your daily massage:





	1. On/Off. Press this button to start actively using your chair. Make sure the chair is plugged in, and press the ON switch on the chair to begin your massage session. If you press this button while the chair is functioning, it will return to its default position and turn off. The remote will also turn off within three to five seconds.
	2. Quick relaxation. Use this button to initiate an automatic eight-minute program focused on relaxation.
	3. Emergency off. This button will stop all massage functions, and the chair will return to its default position and turn off. To return to your massage, restart the remote control using the On/Off button.
	4. Menu. Press this button to explore the numerous functions available. To exit the menu, press the button once more.
	5. Auto. The MC-1000 is equipped with six automatic programs available through this button. With each subsequent push, you can switch the current program. Automatic programs are “Recovery,” “Pain Relief,” “Stretch,” “Rocking Relax,” “Overall,” and “Health Care.” Look at the LCD screen to see the program currently running.
	6. Air pressure. Use the air pressure button to choose an air pressure position and change air pressure settings as indicated on the display.
	7. Intensity. Press this button to adjust the level of intensity available during air pressure massages. This massage chair features 3 levels of intensity, as indicated on the display.
	8. The direction pad. Use the four buttons on the direction pad to move up, down, left, or right on any menu screen. Additionally, you can touch up or down to select the menu and left or right to go to the previous or next menu screen. During point massages and after the acupuncture-point tracking detection test, you may also use the pad to adjust the massage experience.
	9. OK. Use this key to select a menu choice and enter the next screen.
	10. Raise backrest and lower leg rest. Hold this button continually to move the backrest toward a seated position and to lower the leg rest. Release the button to lock your position of choice.
	11. Lower backrest and raise leg rest. Hold this button to recline the backrest and raise the leg rest. Release the button to lock your position of choice.
	12. Zero. Press this button to initiate the zero-gravity position. Your chair will adjust itself and then stop. If you wish to return to the default position, simply press the Zero button once more.

Getting to Know Your LCD Display Screen

Main Interface





 Kneading

 Tapping

 Knocking

 Pressing

 Massage

 Time Left

 Massage Position

 Speed (Massage) - Slow, Medium, Fast

 Width (Massage) - Narrow, Medium, Wide

 Intensity (Air) - Weak, Medium, Strong

Main Interface

Press the On/Off key on your remote control to turn on the compact LCD display screen. You should hear the remote beep once to indicate power. Within two to three seconds, you should see the main interface. If you do not press a button shortly after powering up the device, it will go into standby mode.

The main interface depicts information about your current massage session, including the chair's position, the type of massage, time, and more. The information on the screen will automatically update every time you choose a new function or change your massage settings.

Menu

 Auto	Recovery
 Manual	Pain relief
 Air	Stretch
 Roller	Overall
 Timing	Rock relax
 Language	Health care
 Stop	
 Exit	

😊 Select by the navigation keys

Menu Interface

Press the Menu button on your remote control to enter the menu interface and choose customized massage chair settings. If you are ready to get back to the main screen, press the Menu button again at any time.

System Menu Options



Auto Massage

The first setting available in the menu gives you access to 6 automated massage sessions. Press OK and use the directional arrows to explore each massage session from the menu screen. Press OK again to initiate a session.

NOTE

Each of the subsequent settings inside the menu works in a similar fashion. When you finish exploring the menu, hit the Menu button to leave the menu screen or touch the left directional button to return to a previous setting screen.



Manual Massage

On the main menu screen, navigate down to the Manual item. Inside this setting, you can adjust four aspects of your massage: the mode, width of massaging components, position, and speed. Choose the function of your choice, and navigate to the setting you would like to change.

During a manual massage session, use the up and down directional buttons to adjust your massage position as needed.

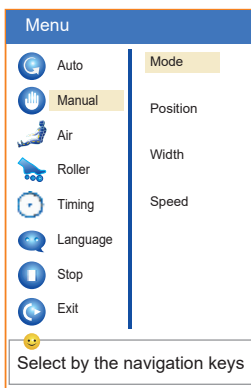

Side Menu Options

<i>Mode</i>	<i>Position</i>	<i>Width</i>	<i>Speed</i>
<i>Knead</i>	<i>Overall</i>	<i>Narrow</i>	<i>Low</i>
<i>Tap</i>	<i>Back Shoulder</i>	<i>Medium</i>	<i>Medium</i>
<i>Knock</i>	<i>Back Waist</i>	<i>Wide</i>	<i>High</i>
<i>Knead & Tap</i>	<i>Fixed Point</i>		
<i>Shiatsu</i>			

23 THE LCD SCREEN



Air

The third menu item controls the air pressure in the airbags. Adjust the position of the pressure and the intensity to create a massage sensation that matches your needs. Press OK to initiate your changes.

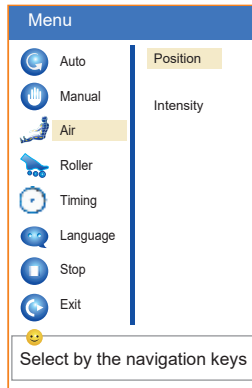

Side Menu Options

<i>Position</i>	<i>Intensity</i>
<i>Overall</i>	<i>Low</i>
<i>Upper</i>	<i>Medium</i>
<i>Middle</i>	<i>High</i>
<i>Lower</i>	



Roller

This menu item allows users to control the foot massage rollers in the footrest. From this screen, choose the mode you prefer: soft, quick, or stop.



Timing

Select Timing to set the duration of your massage session. You have the option to set your massage for 10, 20, or 30 minutes. The chair's default session duration is 20 minutes. When the massage time concludes, the chair will automatically turn off.



Language

Choose the language of your choice from this screen.



Stop

To stop your current massage and return to the main display screen, press this button.



Exit

Press the Menu button to move back to the main interface, or move back to the main setting screen and select OK on Exit.

Auto Recovery Program

The first time you use the auto program on the massage chair, it will initiate its acupuncture-point position-detection test to locate the proper positioning for your body. If you do not like the recommended position, use the directional arrows to adjust the settings when you see the phrase “acupuncture point adjusting” on the screen. When the test finishes, a buzzer will sound five times.

Operating Your MC-1000 Massage Chair

Turn On Your Chair

- The plug at one end of the power cord goes into hole “a.”
- Attach the plug at the other end of the power cord into the wall outlet.
- Press the “1” on the power switch to provide the chair with electricity.
- Press the green On/Off button on the remote control. You should hear a short beep, and the main screen will appear.

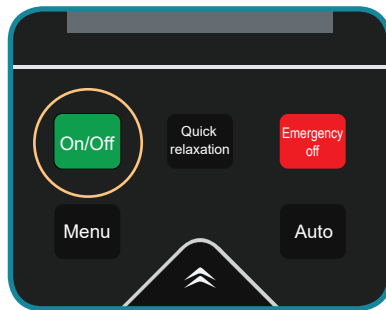
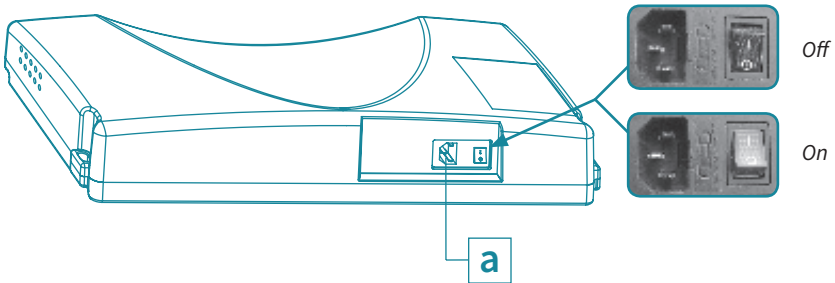

Starting and Ending Your Massage

- Choose your massage setting. Refer to the Remote Control Usage Guide for more information.
- After a massage session ends, the chair will return to its default position and then shut down. The remote control will read “shutting down” and will power off after two to three seconds.

Turning off Your Chair.

- A. If the chair is still on when you decide to end your session, press the On/Off button on your remote control. The chair will return to its default position, and the remote control will shut down.
- B. After the chair and the remote control shut down, locate the power switch near the bottom of the chair's back. Press the "O" toggle to shut off power to the chair.
- C. Unplug the chair from the power outlet.



Always check behind the head pillow and back cushion. Avoid using the chair and call a professional repair technician if you notice any tears or broken PU material. Plug your chair only into an outlet supporting the proper voltage and connection.



Before you sit down in the chair, check moving areas for foreign objects. Remove anything that may inhibit the chair's movement. Do not sit in the chair to begin a session unless and until it moves back into its default position. Never stand on the chair.

Function Cheat Sheet

Raise the Leg Rest and Recline the Backrest

Achieve a fully reclined position when you press this button. The chair will lock into position when you release the button.



Raise the backrest and Lower the Leg Rest

Return to a seated position when you press this button. The chair will lock into position when you release the button.

Zero Gravity

This button automatically reclines the backrest and raises the leg rest to a certain level. If you want to pause during the positioning process, press the button once more. The angle of your chair will not affect the massage modes.



Extend and Retract the Leg Rest

Adjust the seat to your preferences with this setting. The MC-1000 has the ability to move in and out 8 inches.

Initiate arm massage

Place your arms between the arm airbags, and select your desired air pressure massage functionality. The airbags use compression techniques to relieve tension and soothe sore muscles during a massage.



Initiate Shoulder Massage

Use the remote control to select an air pressure shoulder massage mode and feel a compression massage on either side of your shoulders. This massage setting works well to soothe fatigue and shoulder tension.

Initiate a foot roller massage

Select the appropriate level of intensity for your foot roller massage and/or air pressure massage. Allow your feet to rest comfortably in the chair. Foot massage settings are designed to target reflex areas and improve overall body wellness.



Function Cheat Sheet Cont.



Always check for children, pets, and other obstacles before initiating a massage sequence. Keep the gap between the backrest and armrest clear as you adjust chair settings. Do not attempt to leave or put pressure on the chair if the leg rest is in motion. This kind of activity may damage the chair. For more information on using the remote control to guide your massage experience, refer to the Remote Control Usage Guide.

What to Do After Your Massage

1. Look around the chair for any potential hazards including pets and children.
2. Use the manual operation buttons or the On/Off button to return the chair to its default position. If the remote control is still on, turn it off.
3. Place the remote control in the inner area of the right armrest.



4. Place the pillow pad in its original position.
5. Turn off the power to the chair. By pressing “o” on the switch in the back.
6. Unplug the power cord from its external power source. Hold the plug instead of the cord when you do this.
7. Wipe down the chair as necessary.



After a massage session, remember to press the On/Off key on the remote control. Always turn off and unplug the chair to avoid electricity-related accidents. Keep the chair away from moisture, dirt, and direct sunlight.

Cleaning and Maintaining the MC-1000

Follow these instructions as needed to keep your chair clean and well maintained

Cleaning the Synthetic Leather Surfaces

General Cleaning

- Wipe down your chair regularly with a dry, soft, clean cloth.
- Do not use chemical or medical-grade cleaners on synthetic surfaces.

For Deep Cleaning

- Use a water-based solution containing 3–5% natural detergent and a soft cleaning cloth. Squeeze excess liquid from the cloth before cleaning your chair.
- Wipe down PU leather surfaces with this solution.
- Remove excess moisture with a dry cloth.
- Allow your chair to dry fully before using. Do not use a hair dryer or other blower implement to dry your chair.

Cleaning the Cloth Surfaces:

- Use the same weak, natural solution you used to wipe down PU leather surfaces. Wring out your cloth or brush before applying it to the surface of the chair. Note: do not use harsh chemicals or substances such as gas, diluent, or alcohol.
- Gently use brushing movements to clean the surface. Note: using excessive pressure may weaken or damage the cloth.
- Wipe down the surface with a clean damp cloth and then a clean dry cloth.
- Allow the surface to fully dry before using.

Cleaning and Maintaining the MC-1000 Cont.

Follow these instructions as needed to keep your chair clean and well maintained

Cleaning Plastic Components:

- Use a weak, natural solution to clean plastic components. Always wring out your cleaning cloth before applying to dirty parts.
- Wipe down the part with a clean, damp cloth to remove any remaining cleaning solution.
- Allow the part to dry.

Cleaning the Remote Control

- Use an electronics cleaning cloth to wipe any dust from the surface. If the surface requires deep cleaning, use a soft, damp cloth.
- Allow the control to dry completely before using. Note: Do not use alcohol, diluent, or propellant to clean the surface.



A Note on Cleaning: Always take the time to unplug your chair from the wall outlet with dry hands before engaging in any cleaning activities. Only use dry hands to reconnect the plug after cleaning. Failing to take the appropriate measures during cleaning activities could lead to electrocution or burn injuries.

Troubleshooting the MC-1000

If you experience difficulties while using your chair, refer to this section of the operation manual. Contact truMedic® if this section does not address the problem you experience.

Problem	Solution
My massage chair does not work when plugged in and turned on.	The remote control may not be turned ON. Locate and press the ON switch on your remote control.
	You may not have chosen a massage function yet. Press any massage function to initiate the massage experience.
	The chair is not receiving the right amount of electricity. Check the chair and wall outlet connections for contact.
	The chair has a burned out fuse. Replace it with the appropriate fuse.
	The problem is within the inner circuit. Contact an authorized maintenance professional to repair your chair.
Beeping noises inside the chair during massage sessions.	You are probably hearing the air pump, mechanical parts, and motor. This is completely normal.
Difference in Left/Right motors. One is sometimes higher than the other is.	The massage rollers do not always run symmetrically. This is completely normal.
The sound I was hearing inside the chair is much louder now.	You may have used the chair continually for too long. Power down the chair for at least 30 minutes, and then see if you still notice the sound.
	Over time, the internal parts can wear down with consistent use. Some wear and tear is normal. Contact an authorized maintenance professional for repairs.
My massage unexpectedly stopped during a session.	The chair may have lost electricity. Check the power cord for a secure connection.
	You may have used the chair continually for too long. Allow the chair to rest for at least 30 minutes before restarting it.
I cannot move the backrest or leg rest as intended.	Check the surrounding area for clearance. Remove any obstacles that may inhibit the chair from moving adequately.
	The chair may have automatically stopped. Turn off the power to the chair and wait for at least 30 minutes before restarting it.

Problem	Solution
I cannot get the chair to return to its default position.	This may happen if you use the chair continuously for too long or if the massage time frame has ended. If you cannot get the chair to return to its normal position after waiting for 30 minutes, contact an authorized maintenance professional for further guidance.
The electric wires and/or plugs are really hot.	This can occur if you use the chair continuously for too long. Turn off all power, and allow the chair to rest for at least 30 minutes.
	If you notice significant heat during any kind of chair usage, stop using the chair immediately and contact a maintenance professional.



If you notice any problems not listed in this short guide, stop using your chair immediately. Turn off all power and cut the electricity. Contact truMedic® for more information on repair and maintenance at 888-264-1766 or service@trumedic.com

Technical Specifications

Name	MC-1000 Massage Chair
Model	MC-1000
Input Voltage	AC120V - 60Hz AC220V - 50/60Hz AC240V - 50Hz
Safety Design	Class I
Power	200W
NW/GW	Main Body: 82/95kg, Armrest: 16.6/24.5kg
Packing Size (L × W × H)	Main Body: 1380mm × 760mm × 855mm Armrest: 1130mm × 420mm × 795mm

truMedic[®]

TRUCORE DISTRIBUTORS, INC.

LOCATION 252 Indian Head Rd. Kings Park, NY 11754

TEL (888) 264-1766

E-MAIL service@truMedic.com

WEBSITE www.truMedic.com



@truMedicMassage