



12-PACK SOLAR PATHWAY LIGHTS

MODEL # : 10232-8-12BZ(BRONZE) 10232-8-12GM(GUNMETAL)
10232-8-12SS(STAINLESS STEEL)10232-8-12BK(BLACK)
10232-8-12CO(COPPER) 10232-8-12ST(STONE WHITE)

ASSEMBLY AND CARE INSTRUCTIONS
IMPORTANT: Retain for future reference. Read carefully.

CARE AND USE INSTRUCTIONS

For assistance with assembly or installation, parts and customer service, please call

1-800-711-1585

Monday thru Friday
9:00 AM to 5:00 PM (PST)

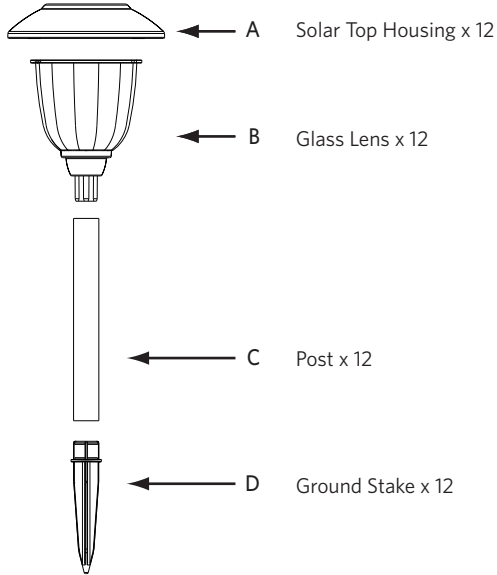

Choosing the Right Location

Your solar lights should be installed in an area that gets DIRECT SUNLIGHT. Your solar lights will produce more hours of operation when installed in an area which is free from cover, shade or shadowing.

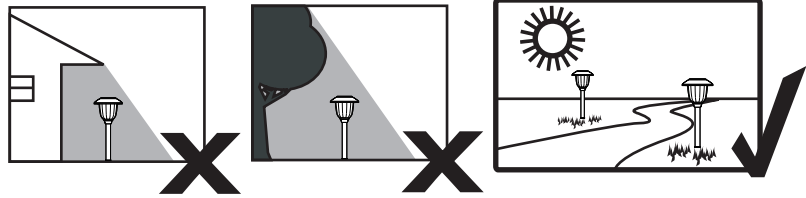

NOTE: If the ground is hard and packed, moisten the ground with water before inserting the stake to avoid breakage.

How Solar Lights Work

Solar lights have a solar cell that converts sunlight into electricity. This electricity is used to recharge the built-in battery each day. Since the solar lights are powered entirely by the sunlight they receive each day, operating time will vary by specific location, daily weather conditions, and season.

Assembly

1 Attaching the post to the ground stake

- Remove inverted ground stake stored inside the post.
- Attach the post (C) to the ground stake (D) by pushing the post (C) onto the top of the ground stake (D).
- Push the post-stake assembly into the ground.

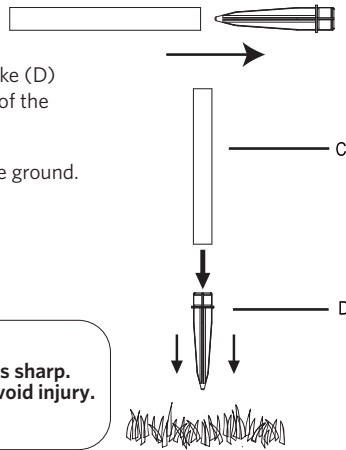

CAUTION: The ground stake is sharp. Be careful when handling to avoid injury.

2 Removing the battery tab

- If light is packaged with the solar top housing (A) attached to the glass lens (B), remove using a counter-clockwise turning motion. If the solar top housing is separate, proceed below.
- Remove the battery tab from the battery compartment on the solar top housing (A).

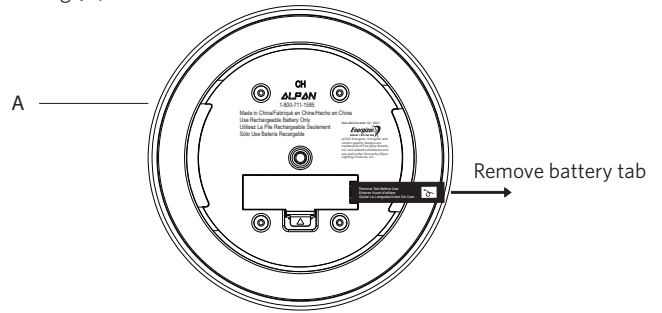

3 Attaching the solar housing

- Attach the solar top housing (A) on top of the glass lens (B) using a clockwise twisting motion.

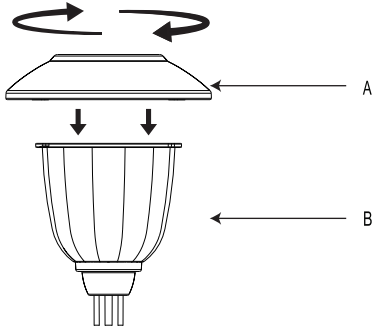

4 Inserting the solar light assembly

- Insert the solar light assembly on top of the post (C).



NOTE: Do not use a hammer. If the ground is hard, use water to soften.



IMPORTANT: Do not press down on the solar panel on top of the solar top housing (A). This can damage the light.

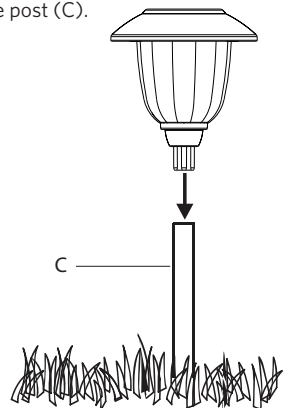

Care & Cleaning

- Clean the solar panel with a damp cloth. Do not use any chemicals or abrasives.
- Keep the solar panel free of snow and debris to allow the battery to charge properly.

Battery Warnings

- Do not use alkaline, standard (carbon-zinc) or Ni-Cd (nickel cadmium) batteries in our solar lights.
- Only use Nickel Metal Hydride rechargeable batteries (includes 12 rechargeable batteries).
- Do not mix battery types. Only use Ni-MH (nickel metal hydride) batteries.
- Adverse conditions of cold, extreme cold, extreme heat plus humidity and dampness may affect battery performance.
- Do not open, short circuit or mutilate batteries as injury may occur.
- Batteries must be recycled or disposed of properly.
- Always purchase the correct size and grade of battery most suitable for the intended use.
- Clean the battery contacts and also those of the device prior to battery installation.
- Ensure the batteries are installed correctly with regard to polarity (+ and -).
- Remove batteries from equipment that will not be used for an extended period of time.
- Remove used batteries promptly.

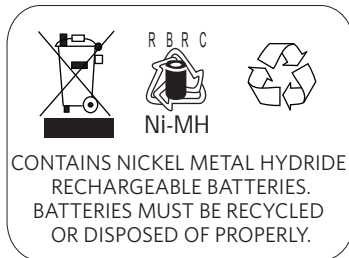

CAUTION: Do not dispose of battery in fire.

Maintenance

Replacing the battery

- Remove the solar light assembly from the post by gently pulling upwards.
- Remove the solar top housing (A) from the glass lens (B) using a counter-clockwise twisting motion.
- Remove the battery cover on the bottom of the solar top housing (A) and replace the battery.
- Re-assemble the unit.

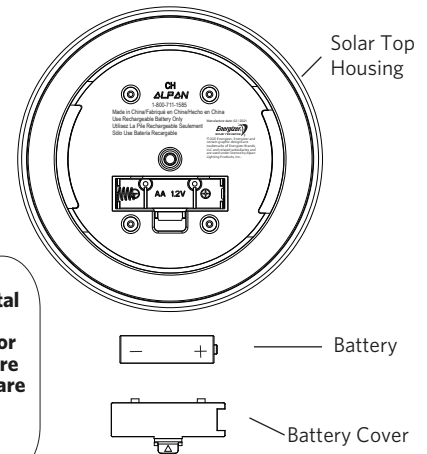
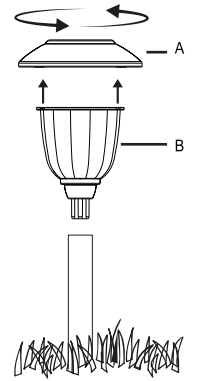

IMPORTANT: Use only AA 700mAh Nickel Metal Hydride (Ni-MH) rechargeable batteries for the solar lights. These are available at most hardware stores or through Alpan Lighting Products at 1-800-711-1585.



IMPORTANT: Dispose of the battery in accordance with local, state and federal regulations.

Troubleshooting

Problem	Solution
Light stops working after period of working properly.	<ul style="list-style-type: none"> □ The battery is not adequately charged. Place the unit in direct sunlight for three sunny days. □ The units are not getting sufficient sunlight. If the sunlight is blocked by a tree, house, or other objects, move the units to a sunnier location. Note that lighting time will be shorter on overcast days. □ The light level is too high for the solar lights to turn on. The solar lights are designed to turn on when it is dark outside. Make sure the solar top housing is not under any direct light source when testing. □ The battery may be weak or can no longer produce a charge. Replace the battery.
The lights only operate for a short duration in the evening.	<ul style="list-style-type: none"> □ The units are not getting sufficient sunlight. If the sunlight is blocked by a tree, house, or other objects, move the units to a sunnier location. Note that lighting time will be shorter on overcast days. □ The battery may be weak or can no longer produce a charge. Replace the battery.

One Year Limited Warranty

Alpan Lighting Products, Inc. warrants this product to be free for one (1) year against any defects that are due to faulty materials or workmanship. Alpan Lighting Products, Inc. shall promptly correct such defects by repair or replacement, at its option. This warranty covers only product defects and shall expire one year after the date of purchase by the original purchaser. Proof of Purchase (Sales Receipt) is required.

This warranty does not apply to (1) bulbs and batteries or (2) defects caused by and resulting from misuse, neglect, accident or improper operation, maintenance, storage, transportation handling of the product. The warranty does not cover any transportation costs for return of the product or for reshipment of any repaired or replaced product, or cost associated with installation, removal or reinstallation of the product. This warranty extends to the original purchaser only and is not transferable or assignable to subsequent purchasers. This warranty does not cover surface scratches, weathering, or natural aging to the patina of fixture finishes as this is considered normal wear.

Alpan Lighting Products, Inc. shall have no responsibility for damage to persons or property or other loss or injury resulting from a defect in the product or from improper use or installation. UNDER NO CIRCUMSTANCES SHALL ALPAN BE LIABLE SPECIAL OR CONSEQUENTIAL DAMAGES. ANY WARRANTIES IMPLIED BY LAW, INCLUDING THOSE OF MERCHANTABILITY AND FITNESS FOR A PARTICULAR PURPOSE, ARE LIMITED IN DURATION TO TWO YEARS AFTER THE DATE OF THE ORIGINAL PURCHASE. In no event shall Alpan Lighting Product, Inc.'s liability under this warranty exceed the cost of repair or replacing such defective product, and Alpan's maximum liability under any warranty is in lieu of all other warranties expressed or implied.

Some states do not allow the exclusion or limitation of special or consequential damages or allow limitations on how long an implied warranty lasts, so the above limitation may not apply to you. This warranty gives you specific legal rights, and you may have rights that vary from state to state. If you feel you have a claim under this warranty, contact consumer service for advice on handling the claim. Written notice of any defects must be given to Alpan Lighting Products, Inc. upon discovery.