

# WYNDHAM COLLECTION

Exterior Size - 59"L x 29-1/2"W x 22-5/8"H  
Interior Size - 56"L x 26-7/8"W x 18"H  
Depth at Drain - 18-1/2"  
Drain To Overflow - 15"  
Maximum Fill - 79 Gallons  
Note - All Measurements are  $\pm 1/2$ "

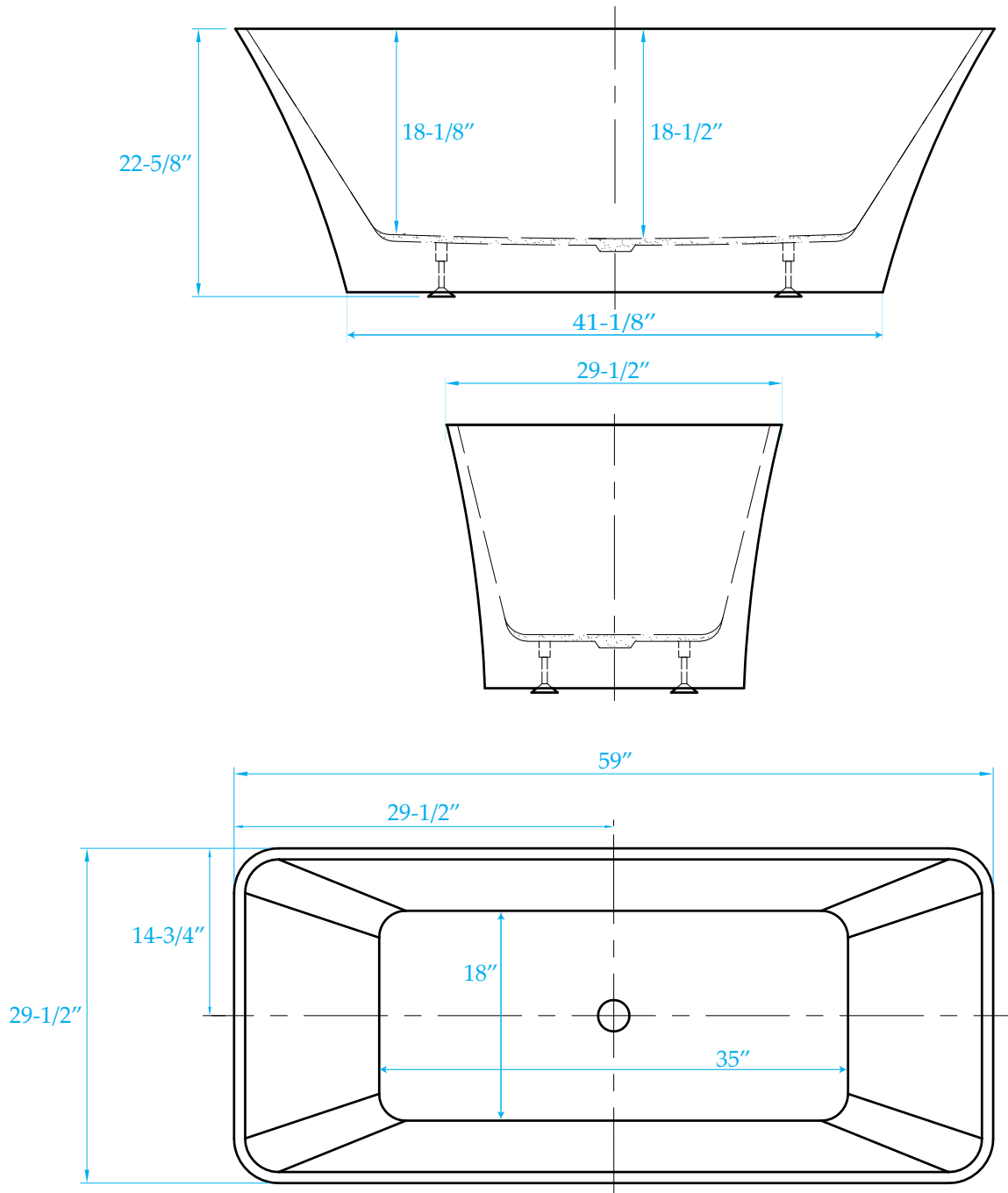

WC-BTK1504-59