



* Assembly Guide & Warranty Card Included

ES700 & ES900 ELLIPTICAL OWNER'S MANUAL



ES700 & ES900 ELLIPTICAL OWNERS MANUAL

IMPORTANT:

All Products shown are prototype. Actual product delivered may vary.
Product specifications, features & software are subject to change without notice.
For the most up to date owner's manual please visit www.truefitness.com.
For documents in additional languages please visit www.truefitness.com/document-library/29/international-manuals

IMPORTANTE:

Todos los productos mostrados son prototipos. La realidad el producto suministrado puede diferir.
Especificaciones de productos, características y software están sujetas a cambios sin previo aviso.
Para la más actualizada de este manual del propietario, por favor visite www.truefitness.com
Para los documentos en otros idiomas, por favor visite www.truefitness.com/document-library/29/international-manuals

IMPORTANT:

Tous les produits présentés sont prototype. Le produit réel livré peut varier.
Spécifications du produit, caractéristiques et logiciels sont sujettes à modification sans préavis.
Pour la plus à jour le manuel du propriétaire s'il vous plaît visitez www.truefitness.com.
Pour documents dans des langues supplémentaires, veuillez www.truefitness.com/document-library/29/international-manuals de visite

重要提示：

显示所有产品的原型。实际交付的产品可能有所不同
产品规格，功能和软件如有更改，恕不另行通知
迄今为止对于大多数的使用说明书，请访问www.truefitness.com
对于其他语言的文档，请访问www.truefitness.com/document-library/29/international-manuals

هام:

جميع المنتجات المعروضة هي النموذج. قد تختلف المنتج الفعلي تسليمها.
مواصفات المنتج، والميزات والبرامج قابلة للتغيير دون إشعار.
www.truefitness.com ما يصل حتى الآن دليل المالك يرجى زيارة
www.truefitness.com/document-library/29/international-manuals للمستندات في لغات إضافية، يرجى زيارة

WICHTIG:

Alle hier gezeigten Produkte sind Prototypen. Das tatsächliche Produkt ausgeliefert wird, kann variieren.
Produkt-Spezifikationen, Funktionen und Software können sich ohne vorherige Ankündigung ändern.
In den meisten Fällen bis zu Bedienungsanleitung Bisher besuchen Sie bitte www.truefitness.com.
Für Dokumente in weiteren Sprachen finden Sie unter www.truefitness.com/document-library/29/international-manuals

BELANGRIJK:

Alle getoonde producten zijn prototype. Daadwerkelijke product geleverd kan verschillen.
Product specificaties, eigenschappen & software zijn onderhevig aan verandering zonder kennisgeving.
Voor de meest actuele handleiding van de eigenaar kunt u terecht www.truefitness.com.
Voor documenten in andere talen kunt u terecht op www.truefitness.com/document-library/29/international-manuals

ВАЖНО:

Все товары указаны прототипа. Фактический продукт, поставляемый могут отличаться.
Технические характеристики, особенности и программного обеспечения могут быть изменены без предварительного уведомления.
Для получения самой последней на сегодняшний день руководство по эксплуатации пожалуйста, посетите www.truefitness.com
Для документов на другие языки, пожалуйста, посетите www.truefitness.com/document-library/29/international-manuals

ES700 & ES900 ELLIPTICAL OWNERS MANUAL

Frank Trulaske, founder and CEO of TRUE, has had the same simple philosophy of delivering superior products, service and support for over 30 years. Today, TRUE is the global leader in premium cardio equipment for the commercial and residential markets. Our goal is to be the leader in technology, innovation, performance, safety and style. TRUE has received many awards for its commercial and retail product over the years and remains the benchmark for the industry. Fitness facilities and consumers invest in TRUE products for their durable commercial platforms used in all its cardio products, both commercial and residential alike.

The proud manufacturing tradition of quality and the culture of innovation at TRUE have given rise to a full line of truly extraordinary treadmills, indoor cycles and elliptical cross-trainers. As a result, people all over the world are benefiting from the TRUE experience. Innovation across the full product line has made TRUE successful and is a trademark of the TRUE heritage. TRUE's patented Heart Rate Control® technology is just one of the remarkable ways we deliver simple and superior performance every user can enjoy, and most importantly, use to achieve personal health and fitness goals.

TRUE strives to perfect biomechanically correct and orthopedically comfortable, functional products. Whether it be the mesh seat in the recumbent bike, the Soft Step® in the elliptical cross-trainers or the Soft System® in our treadmills, we deliver the best.

At the heart of our success is the relentless and systematic life testing of both our products and their components. We have dedicated employees who understand our philosophy is to deliver the best products in the world.

Our goal is not to sell the most cardio products in the world, but to deliver the world's best premium equipment for our customers' health and fitness solutions.

To own a TRUE machine is to be part of an exclusive fitness community that delivers results – your results.

Thank you for becoming a part of the TRUE experience.

TRANSCEND ALL OTHERS!

ES700 & ES900 ELLIPTICAL OWNERS MANUAL

TABLE OF CONTENTS:

Chapter 1: Safety Instructions

Safety Instructions.....	1
Space Requirements.....	3
Grounding Instructions.....	4
Power Requirements.....	5
Warning Decals.....	6
Compliances.....	6

Chapter 2: Assembly Instructions

Pre-Assembly Checklist.....	7
Assembly Steps:.....	8

Chapter 3: Product Overview

Elliptical Overview.....	18
--------------------------	----

Chapter 4: Programming & Operation

Heart Rate Monitoring.....	21
Heart Rate Control.....	21
Program Descriptions.....	23

Chapter 4A: Escalate⁹ Operation

Escalate ⁹ Overview.....	26
Console Navigation.....	28
Advanced Console Functions.....	35

Chapter 4B: Emerge Operation

Emerge Overview.....	40
Console Navigation.....	43
Advanced Console Functions.....	45

Chapter 5: Care & Maintenance

Care & Maintenance.....	46
Cleaning the Equipment.....	46
Leveling the Unit.....	47
Other Scheduled Preventive Maintenance.....	47
Long Term Storage.....	47

Chapter 6: Customer Service

Contacting Service.....	48
Contacting Sales.....	48
Reporting Freight Claims or Parts Damage.....	49



Chapter 7: Additional Information

Troubleshooting Guide.....	50
ES700 Specification Sheet.....	53
ES700 Warranty Registration.....	55
ES900 Specification Sheet.....	58
ES900 Warranty Registration.....	60









CHAPTER 1: SAFETY INSTRUCTIONS

IMPORTANT SAFETY INSTRUCTIONS SAVE THESE SAFETY INSTRUCTIONS

This elliptical is intended for in-home use only; do not use this elliptical in a commercial or institutional setting. Doing so may void the expressed warranty.

-  WARNING: All EXERCISERS MUST READ ALL INSTRUCTIONS BEFORE USING THE ELLIPTICAL.
-  WARNING: Heart rate monitoring systems may be inaccurate for some individuals. Over-exercising may result in serious injury or death. If you feel faint, stop exercising immediately.
-  WARNING: Equipment should be immediately taken out of use if it fails to work properly or when a warning is presented electronically.

TRUE STRONGLY recommends seeing a physician for a complete medical exam before undertaking an exercise program, particularly if the user has a family history of high blood pressure or heart disease, is over the age of 45, smokes, has high cholesterol, is obese or has not exercised regularly in the past year. Additionally, TRUE recommends consulting a fitness professional on the correct use of this product. If at any time while exercising the user experiences faintness, dizziness, pain or shortness of breath, he or she must stop immediately.

-  WARNING: To reduce the risk of electrical shock, always unplug this TRUE product before cleaning or attempting any maintenance activity. Do not handle the plug with wet hands.
-  WARNING: To reduce the risk of burns, fire, electric shock or injury, it is imperative to connect each product to a properly grounded 110V electrical outlet. A risk of electrical shock may result from improper connection of the equipment's grounding conductor. Check with a qualified electrician if you are unsure about proper grounding techniques. Do not modify the plug provided with this product. If it will not fit an electrical outlet, have a proper outlet installed by a qualified electrician. Your TRUE Fitness product must be properly grounded to reduce risk of shock if the elliptical malfunctions. Your elliptical may be equipped with an electrical cord, which includes an equipment grounding conductor and a grounding plug. The plug must be inserted into an outlet that has been properly installed and grounded in accordance with all local codes and ordinances. A temporary adapter cannot be used to connect this plug to a two-pole receptacle in North America. If a properly grounded 15 amp outlet is not available, a qualified electrician must install one.
-  WARNING: Do not move the equipment by lifting the console. Do not use the console as a handlebar during a workout.
-  WARNING: This product contains chemicals known to the state of California to cause cancer and birth defects or other reproductive harm.
-  WARNING: Keep equipment stable on flat ground.
-  WARNING: Replace warning labels that may be worn, damaged or missing
-  WARNING: Replace any non-working or damaged components; remove the unit from service until repair is performed.
-  WARNING: To reduce the risk of burns, fire and electric shock or injury to persons, follow these instructions:
 - This appliance should never be left unattended when plugged in.
 - Do not use any type of extension cord with this product.
 - Unplug it from the outlet when not in use and before any servicing.

CHAPTER 1: SAFETY INSTRUCTIONS

- Do not operate the equipment while being covered with a blanket, plastic, or anything that insulates or stops airflow.

 **WARNING:** Risk of personal injury-crushing hazard when elliptical is in operation - Keep feet, hands, and fingers away from moving parts.

CAUTION:

- Health related injuries may result from incorrect or excessive use of exercise equipment.
- Do not use typing or web surfing features at excessive speeds. Always stabilize yourself by holding a stationary handle when using typing or web surfing features. (Varies by console option)
- Do not use the contact heart rate grips as a handlebar during a workout.
- Any changes or modifications to this equipment could void the product warranty.
- To avoid injury stand on the side rails before starting the elliptical.
- To disconnect, turn power OFF at the ON/OFF switch if applicable, then remove plug from electrical outlet.
- Never operate a TRUE product if it has a damaged power cord or electrical plug, or if it has been dropped, damaged, or even partially immersed in water. Contact TRUE Customer Service.
- Power adapter requirements for the elliptical are 110V AC input and 24V DC 7.5Amp output.
*Note the plug configuration for the power adapter may vary by country.
- Use a TRUE AC power cord or AC/DC adapter only
- Note the plug configuration for the power adapter may vary by country.
- Position this product so the power cord plug is accessible to the user.
- Keep the power cord away from heated surfaces. Do not pull the equipment by the power cord or use the cord as a handle. Do not run the power cord along the side or under the equipment.
- If the electrical supply cord is damaged it must be replaced by the manufacturer, an authorized service agent, or a similarly qualified person to avoid a hazard.
- Do not use this product in areas where aerosol spray products are being used or where oxygen is being administered. Such substances create the danger of combustion and explosion.
- Always follow the console instructions for proper operation. Close supervision is necessary when used near children under the age of 15, or disabled persons.
- Do not use this product outdoors, near water, while wet, or in areas of high humidity including extreme temperature changes
- Never operate a TRUE product with the air openings blocked. Keep air openings free of lint, hair or any obstructing material.
- Never insert objects into any openings in this product. If an object should drop inside, turn off the power, unplug the power cord from the outlet and carefully retrieve it. If the item cannot be reached, contact TRUE Customer Service.
- Never place liquids of any type directly on the unit except in the accessory tray or bottle holders. Containers with lids are recommended.
- Wear shoes with rubber or high traction soles. Do not use shoes with heels, leather soles, cleats or spikes. Make sure no stones are embedded in the soles. Do not use this product in bare feet. Keep all loose clothing, shoelaces and towels away from moving parts.
- Do not reach into or underneath the unit, or tip it on its side during operation.
- Use correct ergonomic positioning while operating the elliptical.
- Do not allow animals on or near the equipment while in operation.

CHAPTER 1: SAFETY INSTRUCTIONS

- Use the side rails or upper exercise arms whenever additional stability is required. In case of emergency, the side rails should be grabbed and the user should place his/her feet on the side platforms. The side rails should be used to grasp the heart rate sensors or to rest the hand on while operating the activity zone keys.
- Do not exceed maximum user weight of 350 lbs. (158kg).
- Avoid exiting elliptical while the foot skate is still in motion
- Do not use if you have a cold or fever.
- When using this exercise machine, basic precautions should always be followed.
- Use this elliptical only for its intended use as described in this manual.
- Do not use attachments not recommended by the manufacturer.
- Allow only trained personnel to service this equipment.
- Avoid the possibility of bystanders being struck or caught between moving parts by making sure that they are out of reach of the elliptical while it is in motion.
- Allow only one person at a time on the elliptical while it's operating.
- It is the sole responsibility of the owner/operator to ensure regular and scheduled maintenance is performed.
- This appliance can be used by children aged from 8 years and above and persons with reduced physical, sensory or mental capabilities or lack of experience and knowledge if they have been given supervision or instruction concerning use of the appliance in a safe way and understand the hazards involved.
- Children shall not play with the appliance.
- Cleaning and user maintenance shall not be made by children without supervision.
- Avoid placing hands on the upper side rail covers while elliptical is in operation. (See Fig 2)

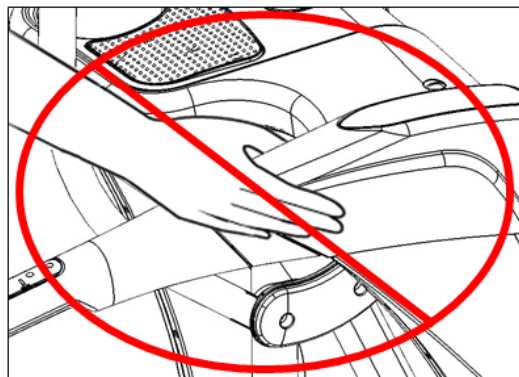
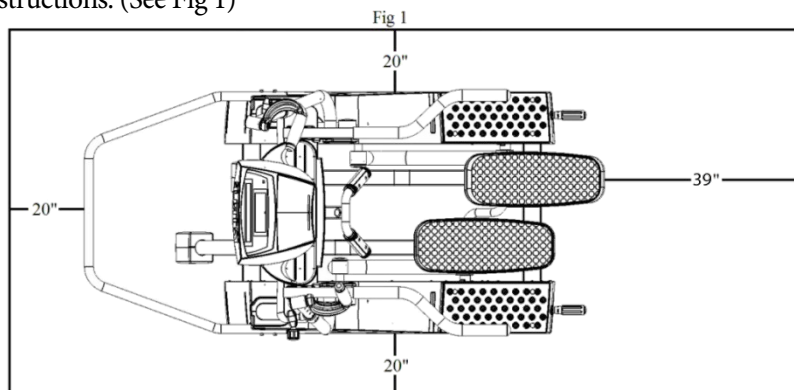

Fig 2

SPACE REQUIREMENTS:

- TRUE's recommendation is to leave a 39" safety zone at rear of elliptical. The sides of the unit should be at least 20" away from the wall or obstructions. (See Fig 1)



CHAPTER 1: SAFETY INSTRUCTIONS

GROUNDING INSTRUCTIONS:

This product must be grounded, if it should malfunction or breakdown, grounding provides a path of least resistance for electric current to reduce the risk of electric shock. This product is equipped with a cord having an equipment-grounding conductor and a grounding plug. The plug must be plugged into an appropriate outlet that is properly installed and grounded in accordance with all local codes and ordinances.

DANGER:

- Improper connection of the equipment-grounding conductor can result in a risk of electric shock.
- Check with a qualified electrician or serviceman if you are in doubt as to whether the product is properly grounded. Do not modify the plug provided with the product. If it will not fit the outlet, have a proper outlet installed by a qualified electrician.
- Do not remove the motor cover or you may risk injury due to electric shock.
- The 120-V model is for use on a nominal 120-V circuit and has a grounding plug that looks like the plug illustrated in figure A. Make sure the product is connected to an outlet having the same configuration as the plug. No adaptor should be used with this product.
- The 230-V model is for use on a circuit having a nominal rating more than 120-V and is factory-equipped with a specific electric cord and has a grounding plug that looks like the plug illustrated in figure B. Make sure that the product is connected to an outlet having the same configuration as the plug in Figure B. No adapter should be used with this product. If the product must be reconnected for use on a different type of electric circuit, the reconnection should be made by qualified service personnel.

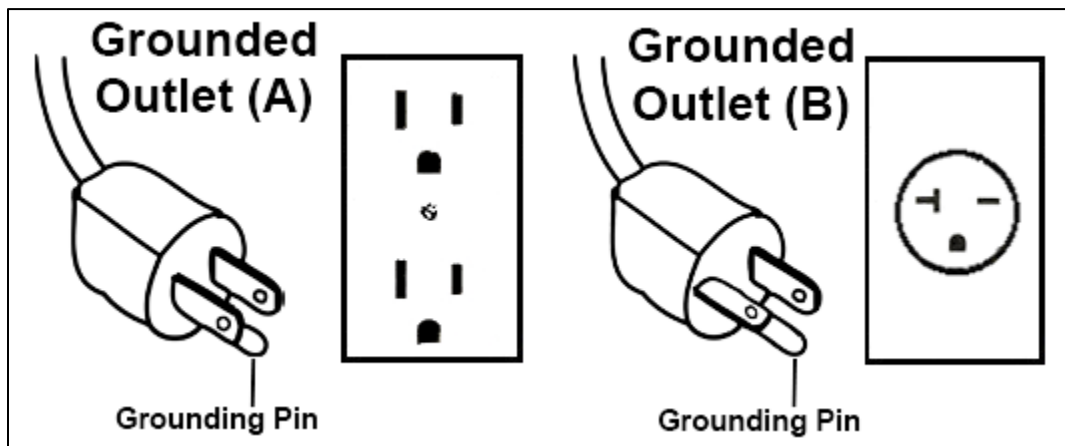

CHAPTER 1: SAFETY INSTRUCTIONS

POWER REQUIREMENTS FOR **TRUE** PRODUCTS

Information Sheet 2010

NOTE: Read and understand all instructions on this sheet and in the Owner's manual before plugging any TRUE power cord into an electrical outlet. This information sheet will help you identify the voltage and cords you need where you live and will outline requirements for:

- Grounded, dedicated lines
- Voltage
- Power cords
- Power adapters
- Extension cords

!DANGER: Improper connection of the equipment-grounding conductor can result in risk of electric shock. Check with a qualified electrician or service provider if you are in doubt as to whether the equipment is properly grounded or installed on a dedicated line. Seek a qualified electrician to perform any modifications to the cord or plug. TRUE is not responsible for injuries or damages as a result of cord or plug modification.

!CAUTION: Place cords away from heat (such as baseboards). Use care to arrange any cord so it doesn't become an obstacle.

Extension Cords

Do not use an extension cord to supply power to any TRUE product.

Grounded, Dedicated Line

TRUE equipment must be grounded. If it should malfunction or break down, grounding provides a path of least resistance for electric current to reduce the risk of electric shock. TRUE cords (except for cycle adapters) have an equipment-grounding conductor and a grounding plug. The plug must be plugged into an appropriate outlet that is properly installed and grounded in accordance with all local codes and ordinances where you live. Do not use a ground plug adapter to adapt the power cord to a non-grounded outlet. Do not use a GFCI outlet or GFCI circuit breaker. A dedicated line will assure that adequate power is available for safe operation over the life of your TRUE Product.

Voltage

Voltage required for your unit is located on the serial number decal (usually on the front of the unit). Depending on where you live voltage requirements differ.

For example, in the United States some TRUE treadmills require a circuit rated 115 VAC, 60 Hz and 20 amps. See Figure 1. However, a home typically has 15 amp outlets. In this case, contact an electrician to install a 20 amp dedicated line prior to use. See Figure 2.

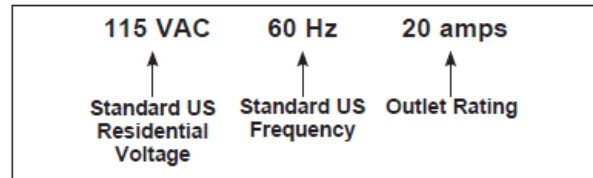

Figure 1

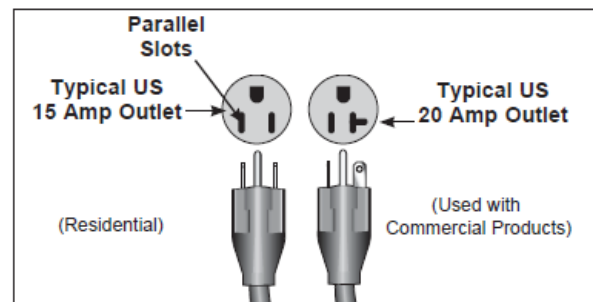

Figure 2

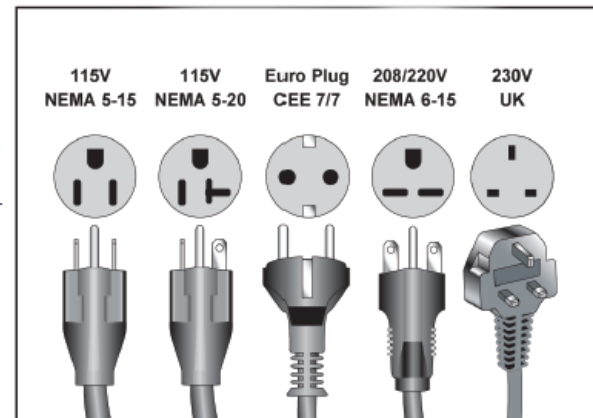



Figure 3

CHAPTER 1: SAFETY INSTRUCTIONS

WARNING DECALS:

 **WARNING:** Replace warning labels that may be worn, damaged or missing.

*To replace any worn or missing warning decals contact TRUE FITNESS by one of the following: www.truefitness.com or contact customer service at 800-883-8783.

**WARNING!**

Read and understand all instructions and warnings prior to use.

All exercise equipment is potentially hazardous. If attention is not paid to the conditions of the equipment usage, death or serious injury could occur.

⚠ CAUTION!

Before exercising, ensure knob has been pulled and fully rotated counter-clockwise to unlock.

TRUE FITNESS TECHNOLOGY, INC.
ST LOUIS, MISSOURI 63366

Model No.
XES700-4

CONFORMS TO ANSI/UL
STD. 1647
CERTIFIED TO CAN/CSA
STD. C22.2 NO.68

Serial No./Date Code
12-XES700001A

Intertek
3110024

Rating:
100-240VAC 50/60Hz 50W

Intertek Testing Services Taiwan Ltd.

MADE IN TAIWAN

TRUE FITNESS TECHNOLOGY, INC.
ST LOUIS, MISSOURI 63366

Model No.
XES900-4

CONFORMS TO ANSI/UL
STD. 1647
CERTIFIED TO CAN/CSA
STD. C22.2 NO.68

Serial No./Date Code
12-XES900001A

Intertek
3110024

Rating:
100-240VAC 50/60Hz 50W

Intertek Testing Services Taiwan Ltd.

MADE IN TAIWAN

COMPLIANCES:

This equipment complies with all applicable codes and regulations. For a complete list of compliances, please visit www.truefitness.com

CHAPTER 2: ASSEMBLY INSTRUCTIONS

IMPORTANT SAFETY INSTRUCTIONS

- **Read and understand all instructions and warnings prior to use.**
- Obtain a medical exam before beginning any exercise program. If at any time during exercise you feel faint, dizzy, or experience pain, stop and consult your physician.
- Obtain proper instruction prior to use.
- Read, understand, and test the emergency stop procedures before use.
- Inspect the elliptical for incorrect, worn, or loose components and do not use until corrected, replaced, or tightened prior to use.
- Do not wear loose or dangling clothing while using elliptical.
- Care should be used when mounting or dismounting elliptical.
- Disconnect all power (if applicable) before servicing elliptical.
- Do not exceed maximum user weight of 350 lbs.
- Keep children and animals away.
- Do not operate an electrically powered elliptical in damp or wet locations.
- All exercise equipment is potentially hazardous. If attention is not paid to the conditions of equipment usage, death, or serious injury could occur.
- Keep the top side of the moving surface clean and dry.
- This machine is intended for residential use only.
- All exercise equipment is potentially hazardous. If attention is not paid to the conditions of the equipment usage, death or serious injury could occur.

*Should you need technical assistance in assembly of your TRUE Fitness product, contact TRUE Fitness Technical Support at 1-800-883-8783.

PRE-ASSEMBLY CHECK LIST:

Tools Required:

- 10mm hex key (Included)
- 8mm hex key (Included)
- 6mm hex key (Included)
- #2 Phillips Screwdriver

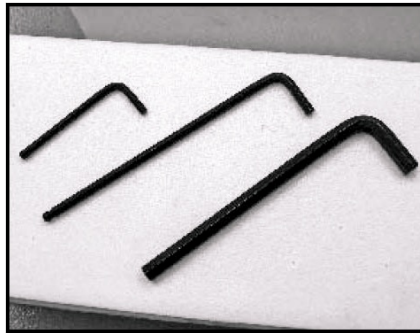

Hardware:

Hardware is packaged in numbered plastic bags that correspond to the step with which they are used. Not all steps require hardware.

CHAPTER 2: ASSEMBLY INSTRUCTIONS

ELLIPTICAL ASSEMBLY STEPS:

⚠ CAUTION:

- It is recommended that two people unpack and assemble elliptical.
- Remove bands from packaging and pull top from pallet.
- Remove all parts from packaging. Leave machine on pallet.
- For each step use hardware in the corresponding bag.

Parts Identification:

Use this page to identify the parts used in each step

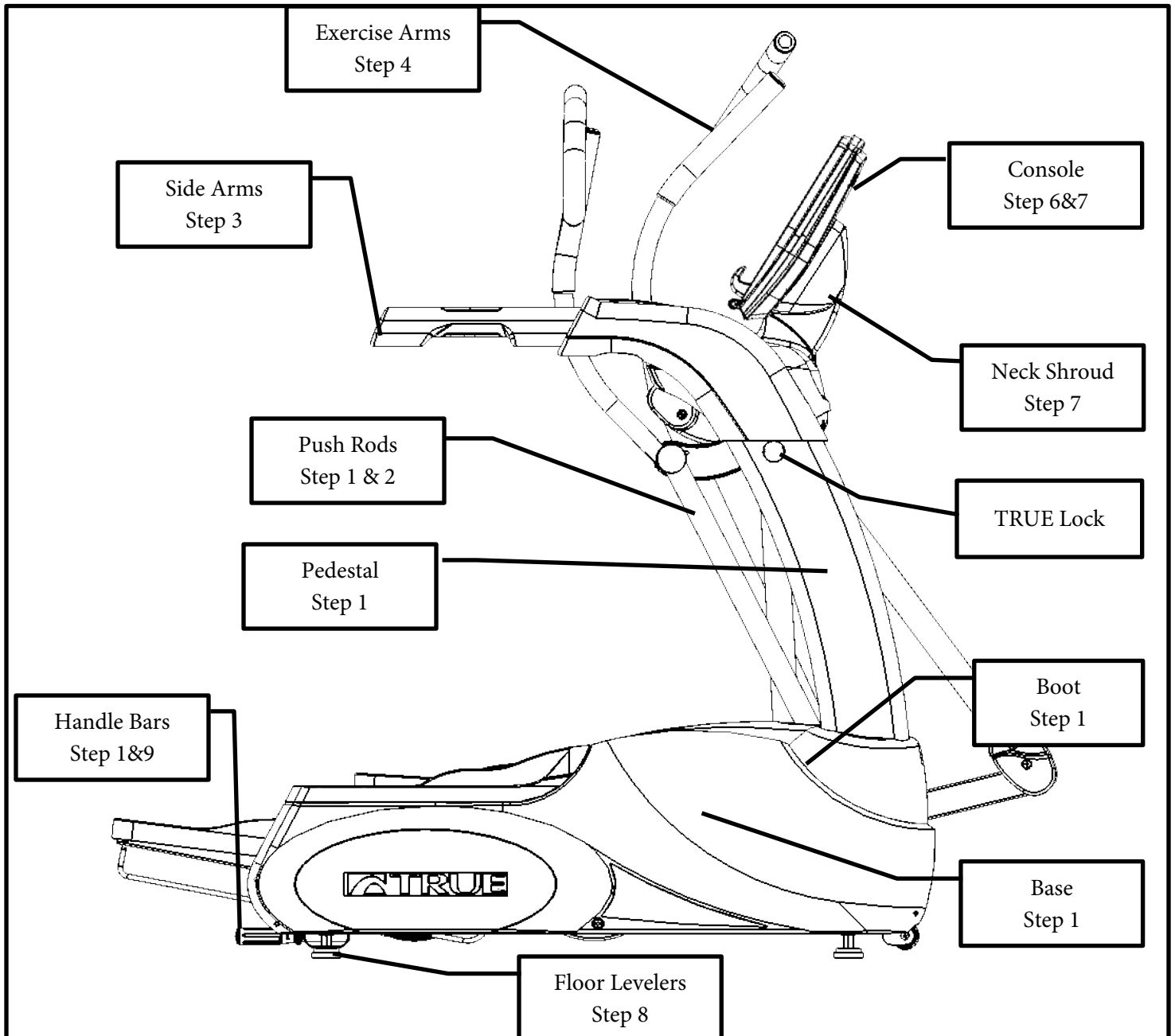

CHAPTER 2: ASSEMBLY INSTRUCTIONS

ELLIPTICAL ASSEMBLY STEPS (CONTINUED):

Pre-Assembly STEP 1: Install Transport Handle Bars:

- Important:** With machine still on pallet, attach handle bars to the front and rear of machine. Handle Bars will provide assistance in moving machine. Figures 1 & 2
- Carefully** remove Elliptical from pallet.
- Important:** **After final machine placement** has been completed, remove transport handle bars from machine and store handle bars with owner's manual.

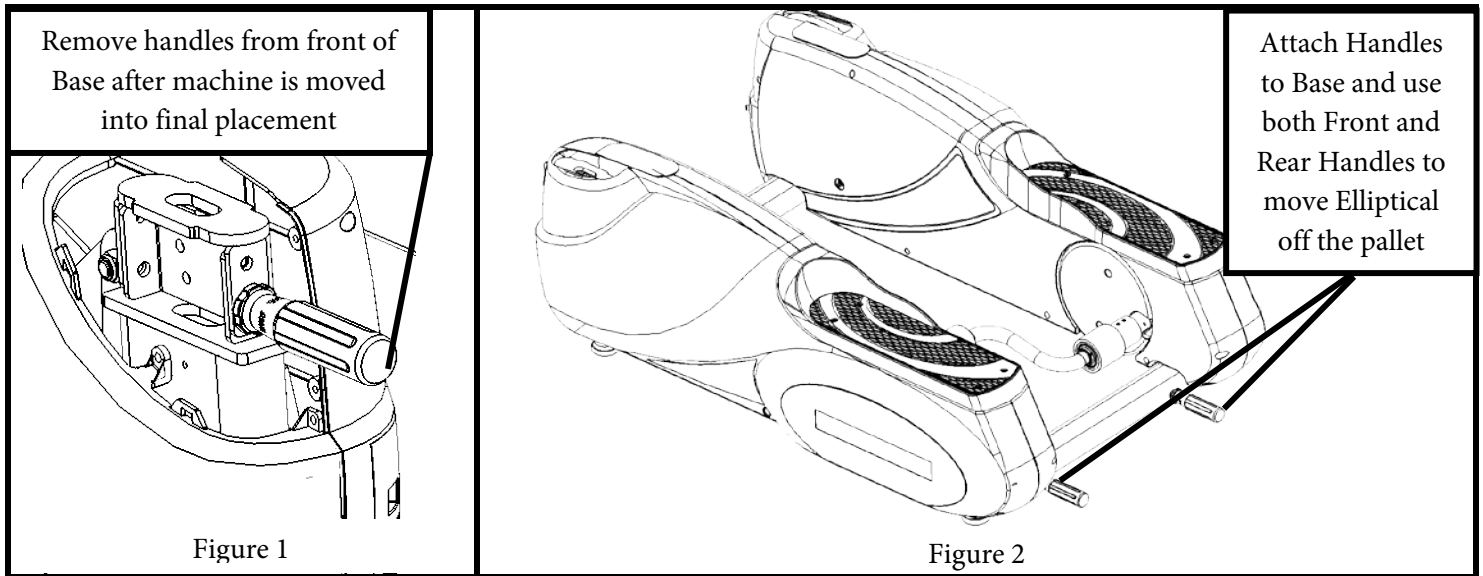

Pre-Assembly STEP 2: Measure Doorways:

- Measure all doorways, hallways and stairwells to make sure that the fully assembled elliptical (33 inches wide) can fit through them.
- If the fully assembled unit will not clear the doors and walls, move all parts to the final location and assemble machine in that location. When moving the machine, keep the left side Styrofoam attached to the Base to help avoid damaging the plastic covers. Set the base on the Styrofoam or the feet only. Figure 4

▲ Please Note When Moving The Elliptical:

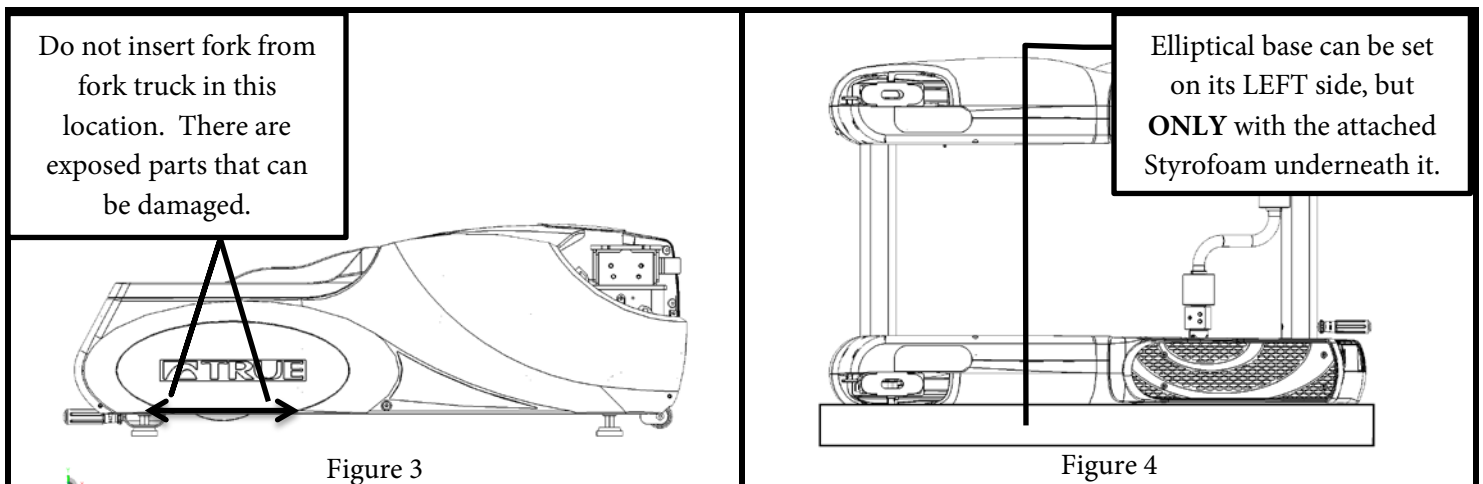

CHAPTER 2: ASSEMBLY INSTRUCTIONS

ELLIPTICAL ASSEMBLY STEPS (CONTINUED):

STEP 1: Attach Push Rods:

a) Rotate crankshaft to the rear on the side that you are installing then insert the push rod as shown.

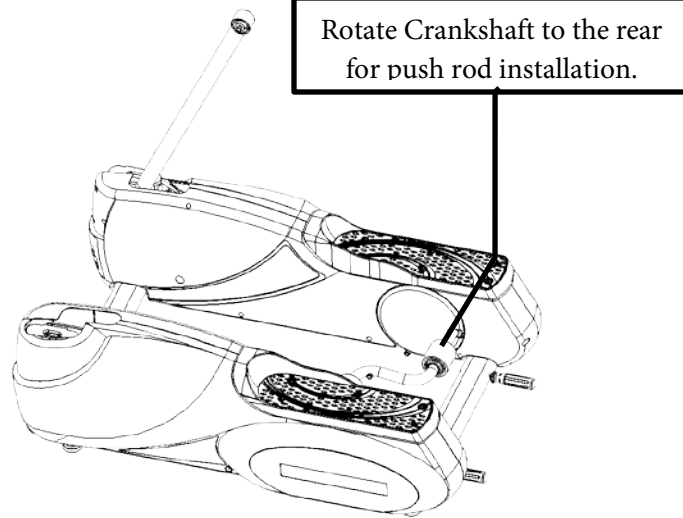

b) Once the pushrod is inside the shroud, rotate the crankshaft forward until the connection joint is accessible through the hole in the shroud.

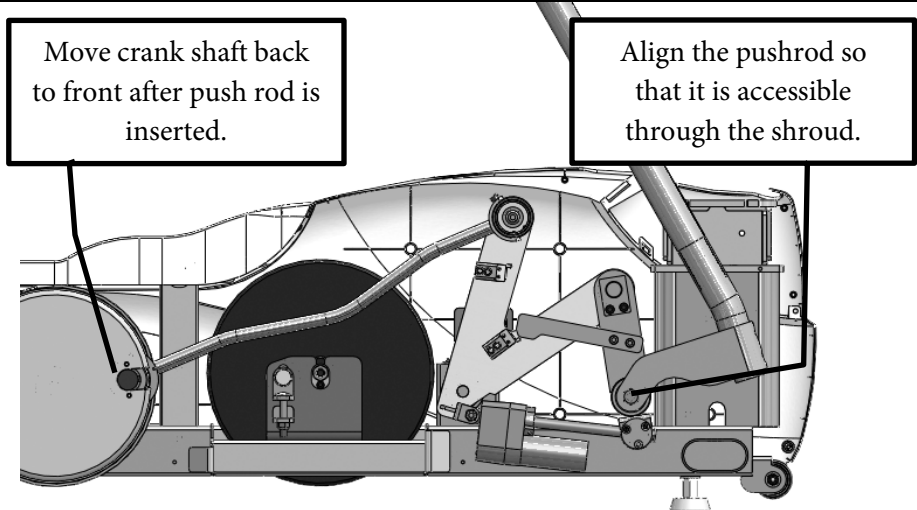

c) Use the Allen wrench to insert the bolt through the shroud and into the joint. Tighten fully.

Hardware Required (Bag 1):

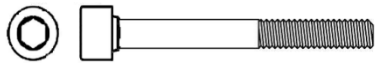

2 M10x55mm Bolts

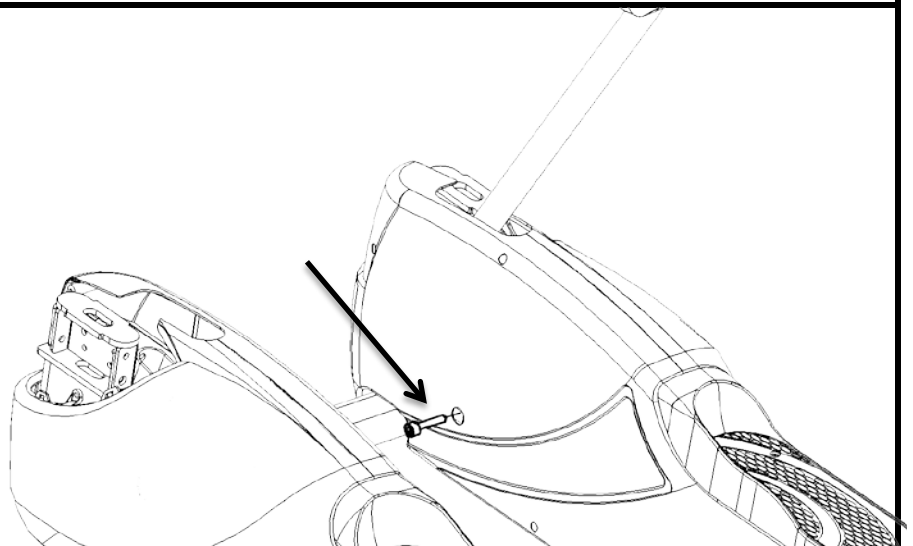

CHAPTER 2: ASSEMBLY INSTRUCTIONS

ELLIPTICAL ASSEMBLY STEPS (CONTINUED):

STEP 1: Attach Push Rods (continued):

d) Place Rubber Cap from Bag 1 in hole after assembly.

Hardware Required (Bag1):



2 Rubber Caps

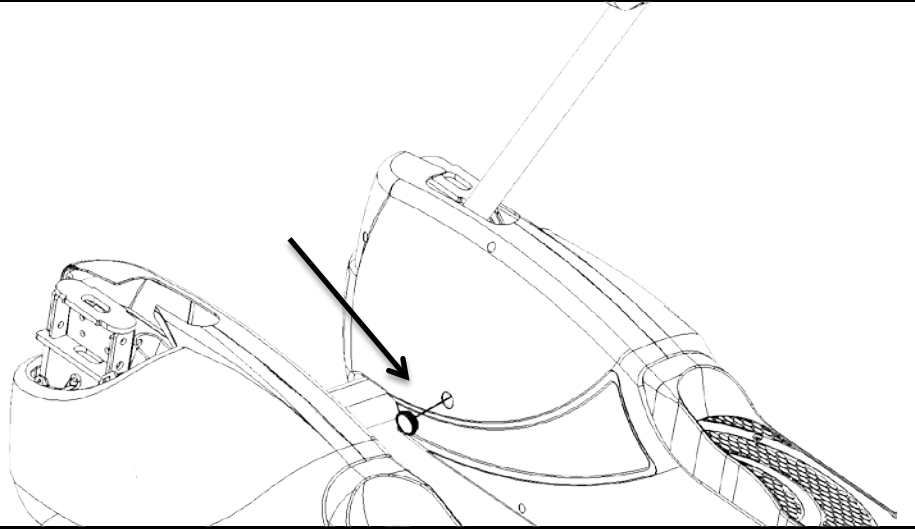

STEP 2: Assemble Pedestal to Base:

a) Remove front handles before assembling pedestal.

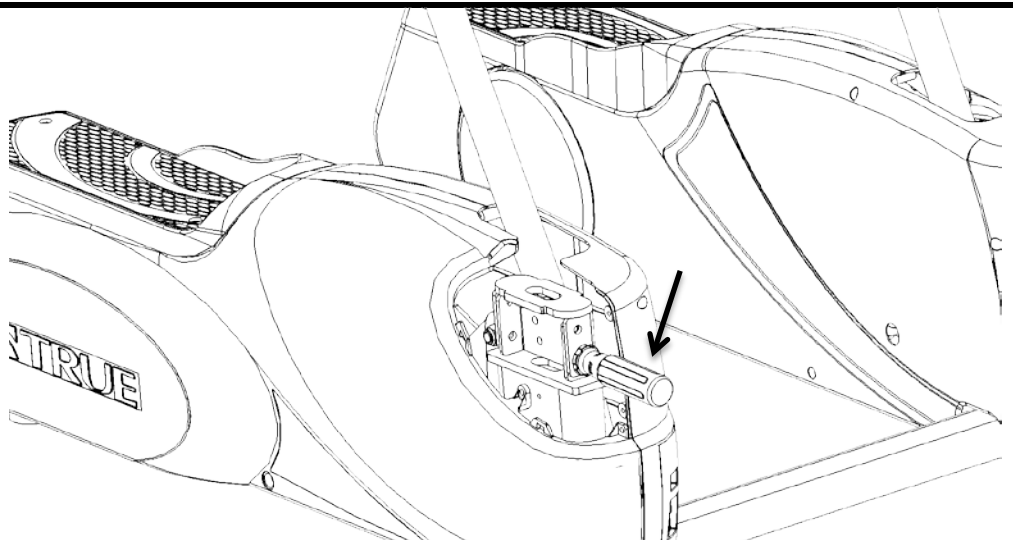

b) Use 2 people to slide the Pedestal straight down onto the Base and be careful to not pinch the wires on the right side of the base.

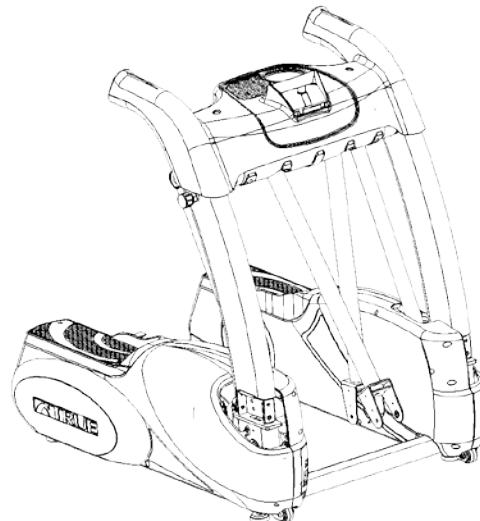

CHAPTER 2: ASSEMBLY INSTRUCTIONS

ELLIPTICAL ASSEMBLY STEPS (CONTINUED):

STEP 2: Assemble Pedestal to Base (continued):

c) Use 2 M12x12mm bolts and 8 M8x12mm bolts to attach Pedestal to Base and connect the 3 cables coming from the right pedestal to the corresponding wires in the base.

Hardware Required (Bag 2):



8 M8x12mm Bolts



2 M12X12mm Bolts

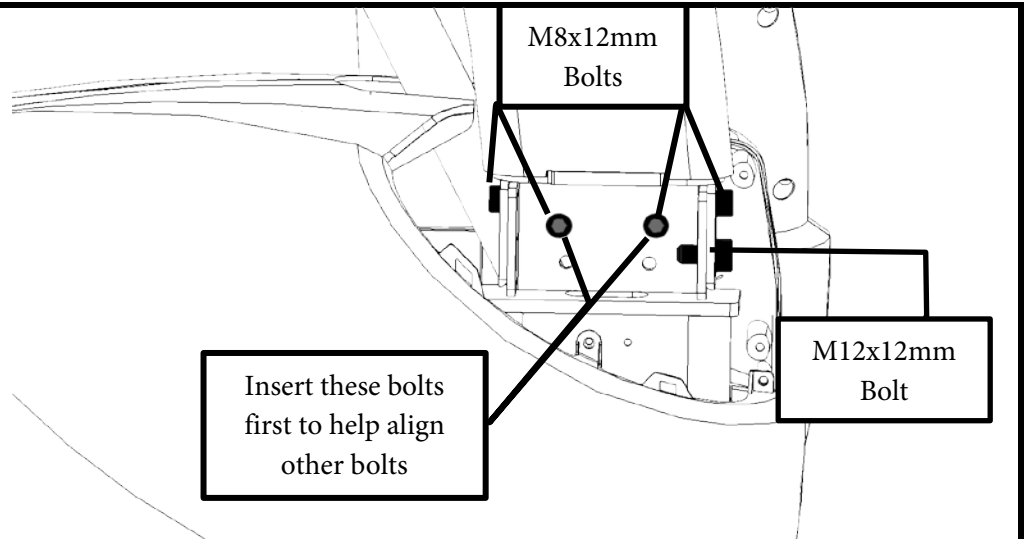

d) Snap the 2 Front Boot Covers into place on the base and use 4 M4 screws to tighten down the Boot Cover.

Hardware Required (Bag 2):



4 M4 Screws

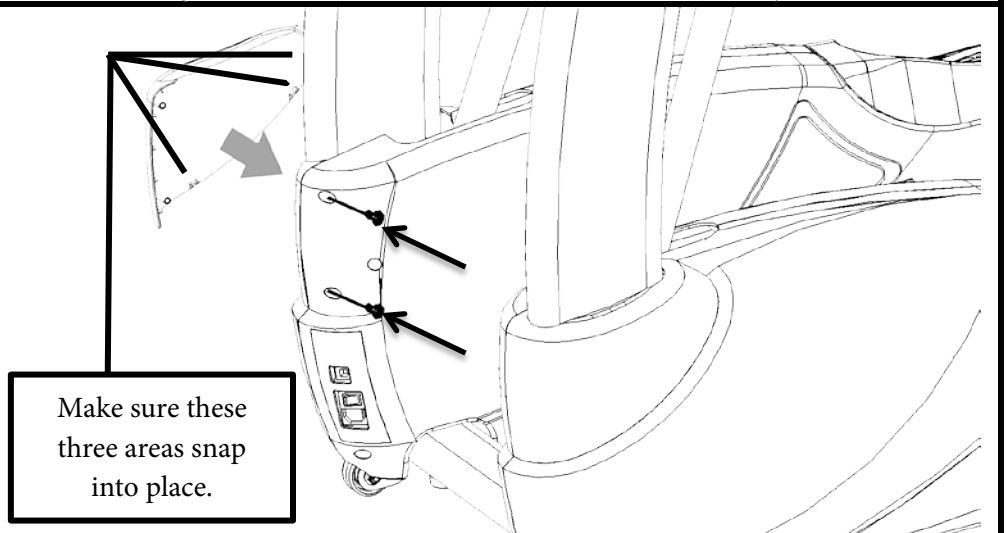

STEP 3: Attach Top of Push Rods:

a) Slide the shaft through the bearing on the top of the push rod and use the bolts, lock washers and flat washers from bag 3 to secure the push rod to the shaft.

b) Use the plastic caps from bag 3 to cover the top of the push rod.

Hardware Required (Bag 3):

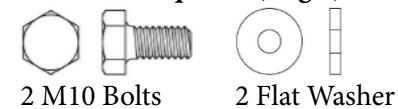

2 M10 Bolts 2 Flat Washer
2 Lock Washer 2 Plastic Caps

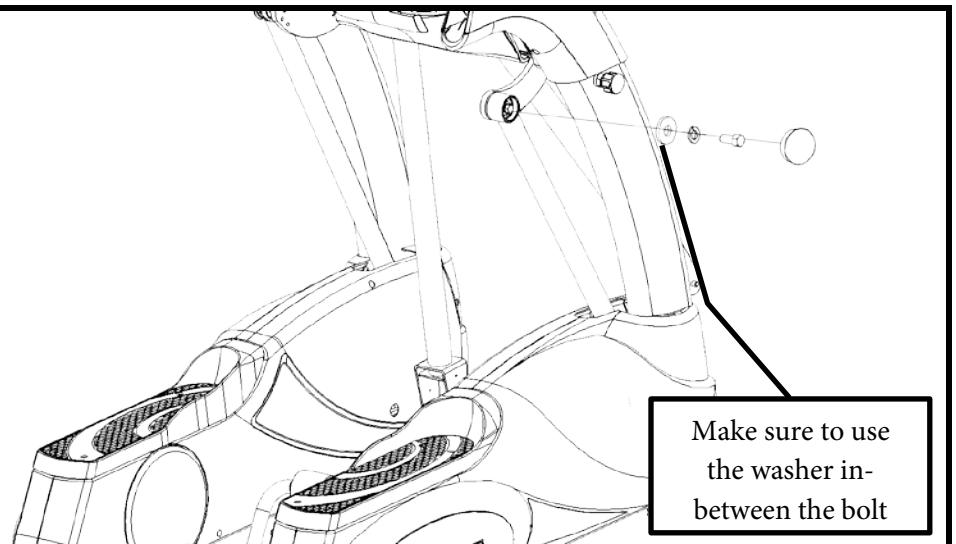

CHAPTER 2: ASSEMBLY INSTRUCTIONS

ELLIPTICAL ASSEMBLY STEPS (CONTINUED):

STEP 4: Attach Side Arms:

- a) Connect Cardio Arm Heart Rate Cable
- b) CAREFULLY Slide Side Arm into Pedestal and tuck the Heart Rate Cable into the plastic housing. Make sure to not pinch the Heart Rate Cable wires.

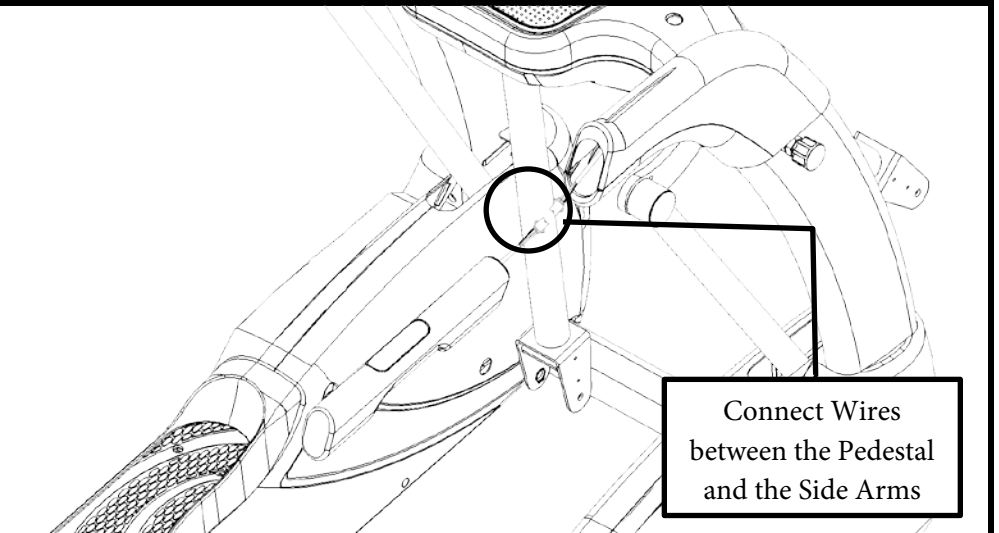

- c) Use 4 M8x12mm bolts to tighten the Side Arms into the underside of the Pedestal.

Hardware Required (Bag 4):



4 M8x12bolts

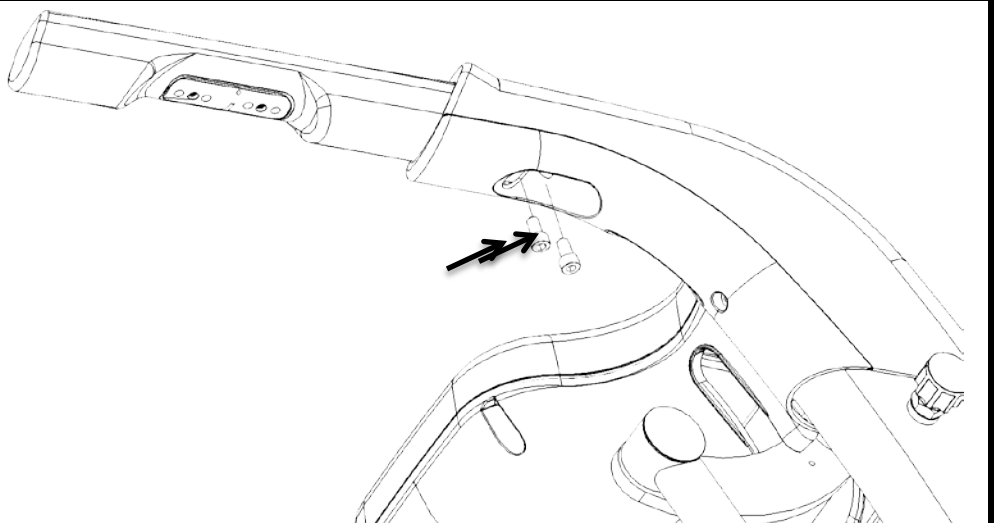

STEP 5: Attach Upper Body Cardio Arms:

- a) Install each upper arm with 4 M8x20mm bolts and 4 lock washers using an 8 mm hex key.
- Note:** Upper Arms are labeled “L” for Left and “R” for Right.

Hardware Required (Bag 5):



8 M8x20mm Bolts



8 Lock Washer

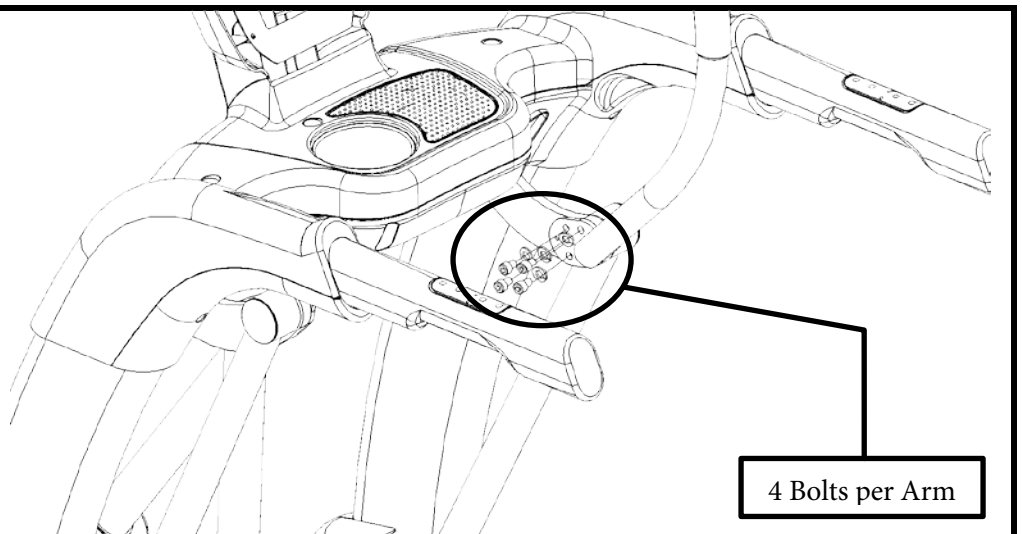

CHAPTER 2: ASSEMBLY INSTRUCTIONS

ELLIPTICAL ASSEMBLY STEPS (CONTINUED):

STEP 5: Attach Upper Body Cardio Arms (continued):

b1) Attach the inner Cardio Arm Covers using 2 M5x8mm screws.

Hardware Required (Bag 5):



4 M5x8mm Screws

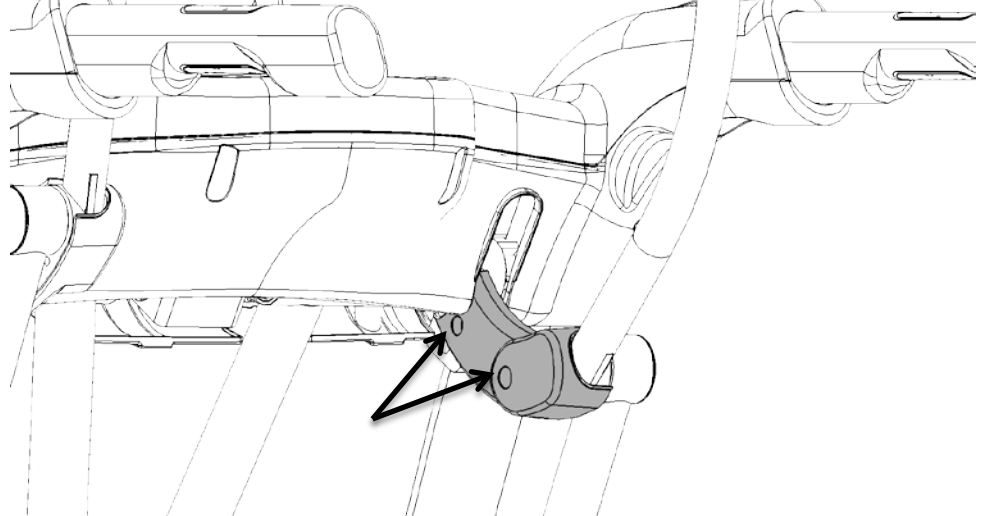

b2-ES900 ONLY) Attach the outer Cardio Arm Covers using 2 M5x8mm screws.

Hardware Required (Bag 5):



4 M5x8mm Screws

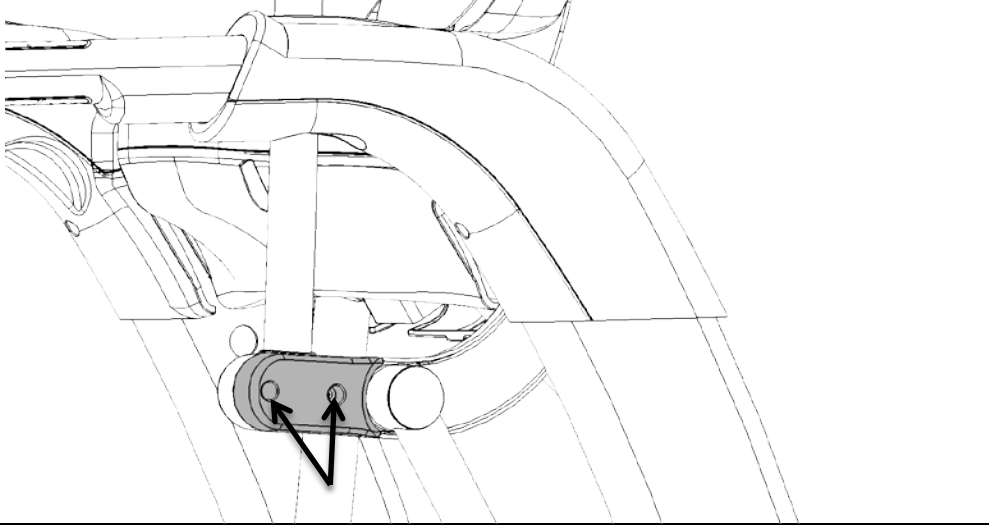

STEP 6: Attach Pedal Tubes:

a) Use 2 M10x80mm bolts and M10 nuts to attach Pedal Tubes. Make sure that pedal tubes are centered on the rollers on the Crankshaft before tightening the bolts.

Hardware Required (Bag 6):



2 M10x80mm Bolts



2 M10 Nuts

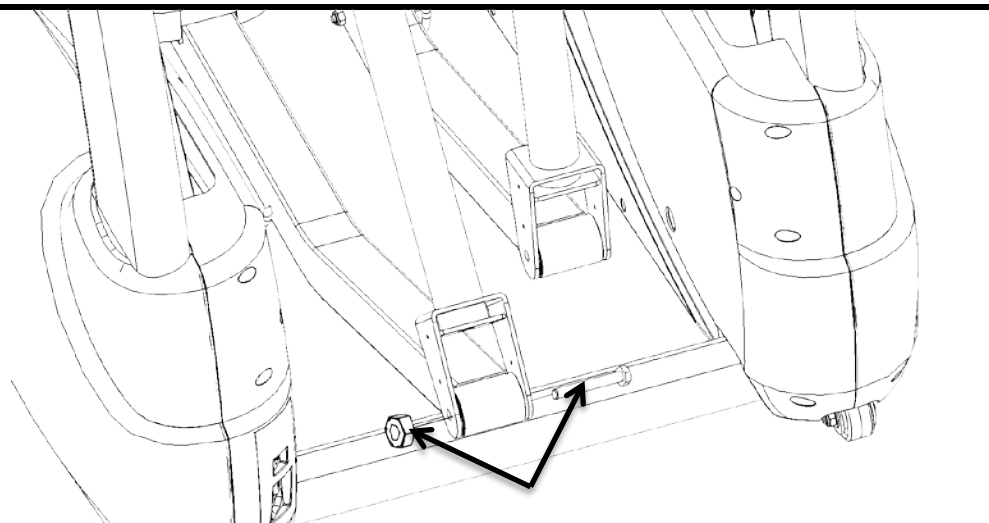

CHAPTER 2: ASSEMBLY INSTRUCTIONS

ELLIPTICAL ASSEMBLY STEPS (CONTINUED):

STEP 6: Attach Pedal Tubes (continued):

b) Attach the Front Pedal Tube Covers using 8 M5x12mm screws.

Hardware Required (Bag 6):



8 M5x12mm Screws

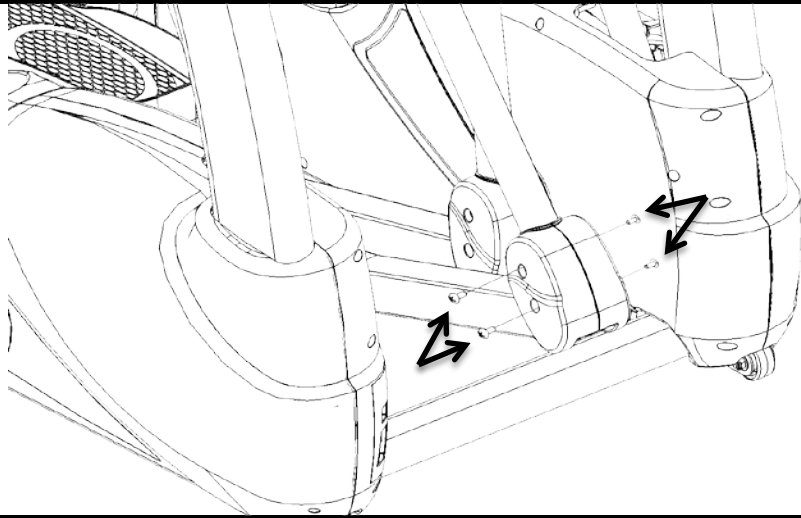

STEP 7: Attach Console:

a) Slide Console cables through Console Mast and attach Mast using 2 M8x12mm bolts.

CAUTION: Do not pinch wires!

Hardware Required (Bag 7):



2 M8x12mm Bolts

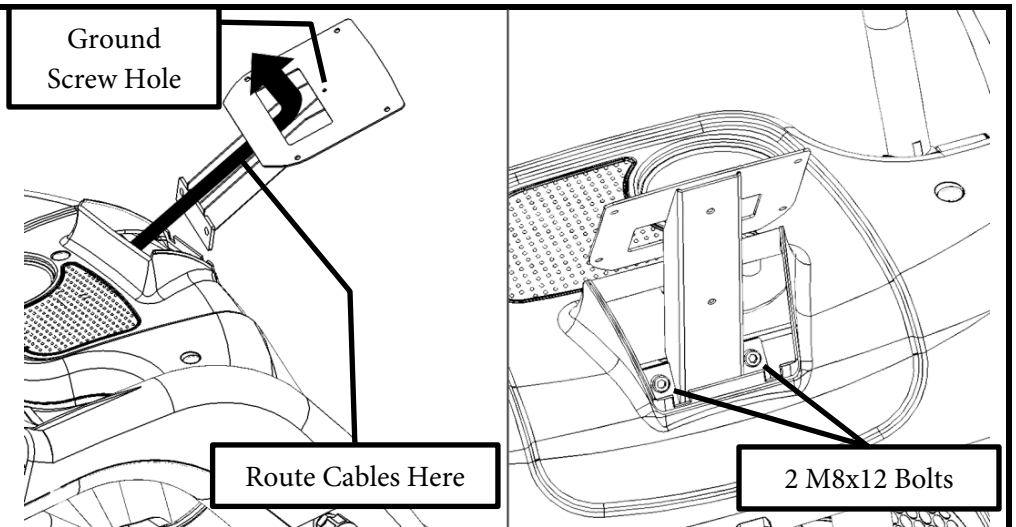

CHAPTER 2: ASSEMBLY INSTRUCTIONS

ELLIPTICAL ASSEMBLY STEPS (CONTINUED):

STEP 7: Attach Console (continued):

- a) Attach the wires coming out of the top of the neck to the back of the console as shown under the picture of **The Correct Console**. Remove the Ground Screw from the plate on the neck and use it to screw the Ground Connector back into the same hole.



Orange LED Console



9" TFT Console

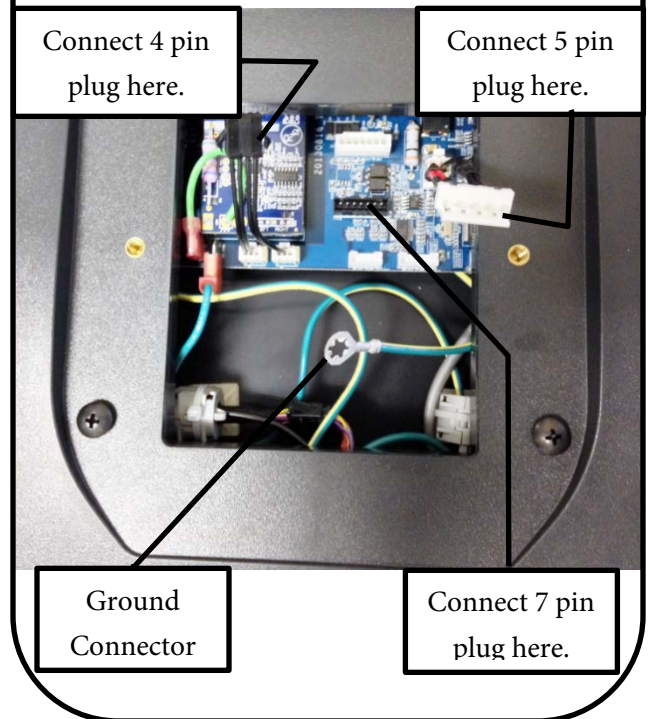
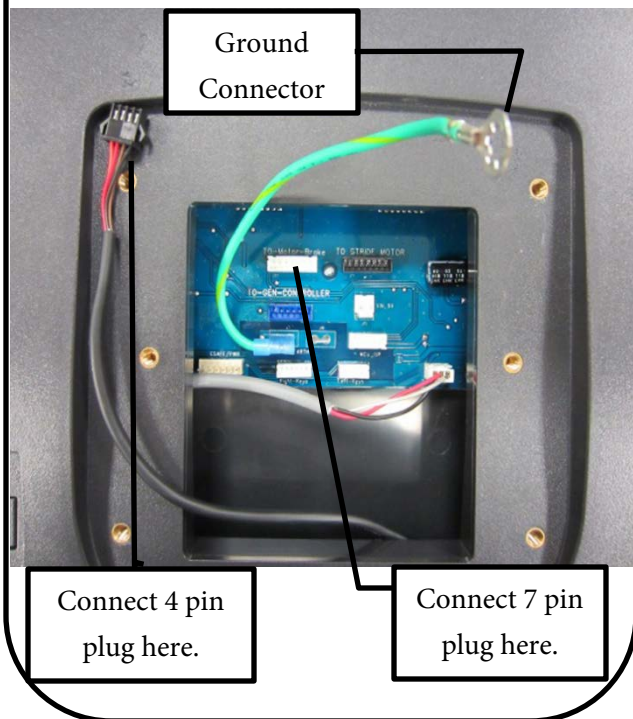

Note: The network cable is built in for future use and is not used for this installation.

CHAPTER 2: ASSEMBLY INSTRUCTIONS

ELLIPTICAL ASSEMBLY STEPS (CONTINUED):

STEP 7: Attach Console (continued):

b) Tuck access wires into the neck and attach the console to the neck using the 4 bolts included with the console.

Required Hardware:

Included with console

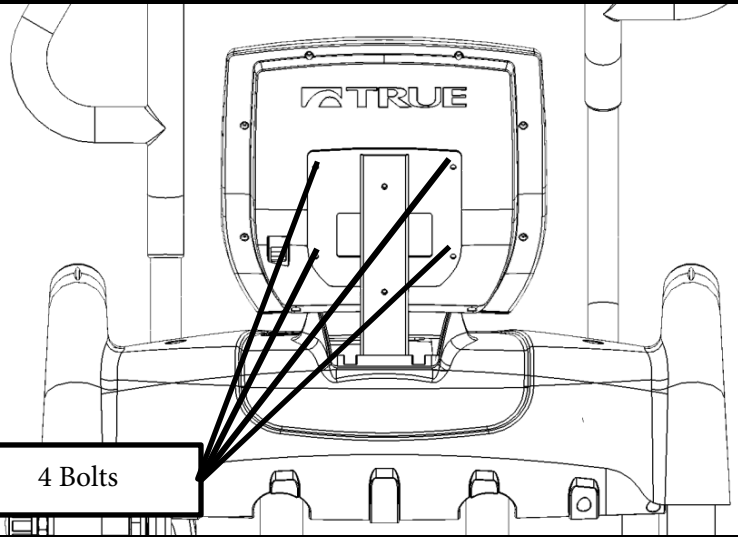

c) Attach the Rear Console Cover using 2 M5x12mm screws.

Required Hardware (Bag 7):



2 M5x12mm Screws

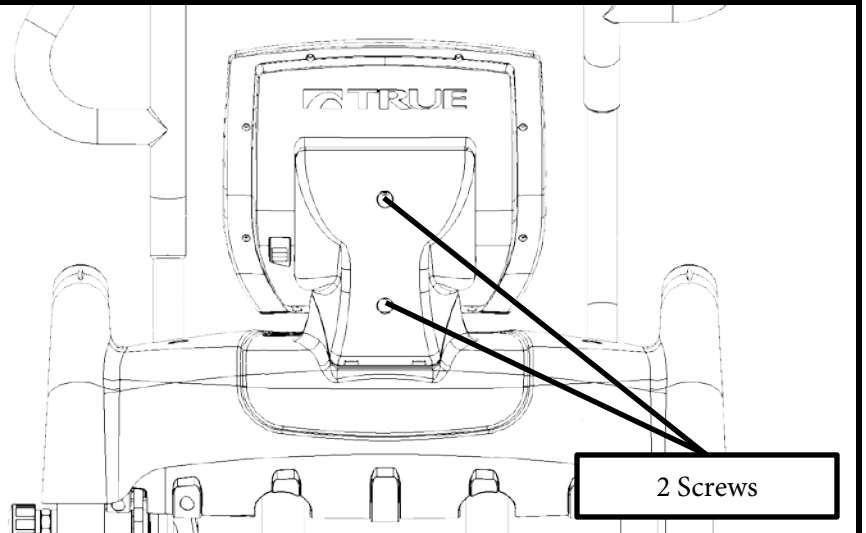

STEP 8: Floor Levelers:

a) If necessary, adjust four levelers on bottom of machine to accommodate uneven flooring.

STEP 9: Remove Transport Handle Bars:

a) Once Elliptical is moved into its final location, remove the two Handle Bars on the back of the machine and store with owner's manual for future use.

STEP 10: Remove Protective Film from Decals:

a) Once Elliptical is moved into its final location, remove the protective film from the decals and from the "True" on the lower shroud.

CHAPTER 3: PRODUCT OVERVIEW

ELLIPTICAL OVERVIEW:



CHAPTER 3: PRODUCT OVERVIEW

ELLIPTICAL OVERVIEW (CONTINUED):

Console Assembly:

The console allows the user to set up a workout program and control the elliptical during a workout.

Upper Exercise Arms with Multi Grip Handles (ES700):

Ergonomic Multi-Grip Handles that provide resistance to the upper body during a workout.

Upper Exercise Arms with Revolving Handles (ES900):

Ergonomically designed rotating handles, with upper-body only capability height adjustment, that provide resistance to the upper body during a workout.

Upper Exercise Arm Height Adjustment Knob (ES900):

Allows the user to adjust the height of the upper exercise arms to a comfortable position.

Side Rails with Contact Heart Rate Pads:

Stationary side arms that can be used to aid users in mounting and dismounting the machine or in case of emergency. The built in contact heart rate pads allow users to check their heart rate without wearing a wireless chest strap.

Side Steps:

The stationary steps on either side of the elliptical, which allow the user to safely straddle the footpads during startup, to isolate upper body, or in the event of an emergency.

Transport Handles Access:

Threaded sockets in the frame of the elliptical that will accept the transportation handles.

Foot Pads:

Moving pedals on the elliptical that provide resistance to the lower body during a workout.

Leveling Feet:

An adjustable system used to aid in the leveling the elliptical.

Power Cord:

Delivers power from the wall outlet to the elliptical.

On/Off Switch:

Allows users to turn the power on or off to the elliptical.

CHAPTER 3: PRODUCT OVERVIEW

ELLIPTICAL OVERVIEW (CONTINUED):

TRUE Lock™ (exercise lock feature):

The ES700 and ES900 ellipticals include the TRUE Lock. This feature allows users to immobilize the foot pedals. By locking the exercise machine, a user can create a more stable foot pedal when entering and exiting the machine. TRUE Lock also prevents unintentional foot pedal movement when the machine is stored and not in use.

Operating Instructions:

The TRUE Lock knob is designed to be positioned in either the locked or unlocked position. Always make sure it is secured fully in one of these positions. To operate, first pull knob to disengage, and then simply turn in the appropriate direction. Once you have reached the correct position, release knob.

⚠ CAUTION:

Before exercising, ensure knob has been pulled and fully rotated counter-clockwise to unlock.

⚠ CAUTION:

When locking the device, ensure knob has been pulled and fully rotated clockwise to lock. Foot pedals must be in the neutral (at rest position) to lock. To ensure the system is locked, slightly move one of the foot pedals fore or aft. If system is locked only very slight movement is possible. If foot pedal is not locked, re-check knob for full rotation in the clockwise direction and move foot pedal until locking pin engages.



CHAPTER 4: PROGRAMMING & OPERATION

HEART RATE MONITORING:

This elliptical can monitor a user's heart rate using either a Polar® compatible chest strap or the metal grips on the hand rails (called contact heart rate or CHR pads). A chest strap transmits the user's heart rate to the elliptical via radio, and the CHR pads connect to a special computer circuit to extract the user's heart rate.

Chest Strap Heart Rate Monitoring:

Although this elliptical functions fine without using the heart rate monitoring feature, this kind of monitoring gives valuable feedback on the user's effort level. Chest strap monitoring also allows users to use Heart Rate Control, the most advanced exercise control system available. When users wear a Polar® compatible transmitter strap, the elliptical will display the user's heart rate as a digital beats-per-minute (bpm) readout.

The transmitter strap should be worn directly against the user's skin, about 1-2 inches below the pectoral muscles/breast line. Women should be careful to place the transmitter below their bra line.

Initially the transmission signal for heart rate may be erratic or non-existent. Some moisture is necessary between the strap and the user's skin for proper transmission. Sweat from exercise works best, but ordinary tap water may be used prior to the workout if desired.



A Note on Chest Strap Heart Rate Monitoring:

The chest strap produces a radio signal that the elliptical reads and registers as the user's heart rate. The accuracy of a reading may be affected when outside interference is present.

Contact Heart Rate (CHR):

The CHR system will let the user monitor their heart rate without wearing a chest strap. When using the CHR system users should gently grasp the CHR pads with both hands. Within 30 seconds, the user's heart rate should be displayed as a digital bpm readout (during the first 30 seconds the system is analyzing and locking in the user's heart rate). Users should exercise with smooth body motions and breathe regularly. It is best to avoid talking while using the CHR system, as talking will cause unrepresentative heart rate spikes of 5 to 10 bpm. To ensure an accurate reading, the user's hands should be clean, free of both dirt and hand lotions.

A Note on CHR Accuracy:

CHR monitoring may be less accurate than chest strap monitoring since the heart rate signals are much stronger at the chest.

HEART RATE CONTROL (HRC):

Introduction:

You are now the owner of the most sophisticated Heart Rate Control equipment available. TRUE HRC is unique and patented. It accommodates users from rehabilitation to world class athletes, and all those in between. TRUE HRC allows users to do a completely adjustment free heart rate controlled workout. By training at a specific target heart rate, users can exercise at a more efficient cardiovascular level.

CHAPTER 4: PROGRAMMING & OPERATION

HEART RATE CONTROL (CONTINUED):

The TRUE HRC system is unique because users must enter the key parameters of the workout; target heart rate, weight, age, and time, prior to beginning the HRC workout. As users approach their target heart rate, the elliptical's computer takes full control over the workout and changes the workout intensity automatically to keep users near their target heart rate. This allows for a completely "hands free" workout.

Target Heart Rate:

TRUE's heart rate control (HRC) workouts let the elliptical monitor relative exercise intensity by way of the user's heart rate, then automatically adjust the workout intensity to keep the user at their target heart rate and thus their desired exercise intensity. Heart rate is a good measure of the body's exercise stress level. It reflects differences in physical condition, fatigue, the comfort of the workout environment, even diet and emotional state. Users should compare their heart rate with how they feel to ensure safety and comfort.

Consult a physician to determine target heart rate:

Using heart rate to control a workout takes the guesswork out of the workout settings. Consult a physician before using heart rate controlled workouts for advice on selecting a target heart rate range. Also, it is important to use the elliptical for several workouts in the manual mode while monitoring heart rate. Users should compare their heart rate with how they feel to ensure safety and comfort. After users have spent some time learning how their heart responds to different workout intensity levels, they will have a better understanding of how to use the elliptical to reach their target heart rate.

Warm Up:

At the beginning of an HRC workout, the elliptical is in full Manual Control mode. Users should gradually increase the workout intensity to slowly raise their heart rate to within 10 beats per minute (bpm) of their target heart rate. The elliptical will operate as if in manual mode during the warm up stage. Users control the workout intensity. It is important that the user starts at a low level of perceived exertion and gradually increase the workout intensity over several minutes until they approach their target heart rate. This allows the body to adapt to the workout. Increasing the workout intensity gradually will allow the user to enter the heart rate control stage without overshooting their target, keeping their heart rate within a few bpm of their target.

*Warming up too fast may cause the user to overshoot their target. If this occurs it may take several minutes before the computer software can control their heart rate. Users may overshoot and undershoot for several minutes until control is achieved.

Heart Rate Control Stage:

The elliptical takes full control of the workout intensity, keeping the user's heart rate within a few bpm of their target. When using the Interval HRC Workout, the elliptical alternates between work and rest intervals.



Cool-Down:

At the end of the workout time or distance, the elliptical reduces the workout intensity by half and goes back into Manual Control mode, where users directly control their cool-down.

CHAPTER 4: PROGRAMMING & OPERATION

PROGRAM DESCRIPTIONS:

Available programs vary depending on the console option selected. Please refer to the chart below for assistance in determining which programs are available on this unit.

Console Options	**	*
 <p>Escalate⁹</p>	YES	YES
 <p>Emerge</p>	YES	

Quick Start: **

A workout in which the user controls all settings. The workout continues until it is ended by the user.

Manual: **

Users set up their own workout to a TIME or DISTANCE limit

Hill Intervals: **

Hill Intervals are in 2-minute segments with increased WORKLOAD to simulate hills.

Rolling Hills: **

A series of gradual increasing and decreasing WORKLOAD changes that simulate rolling hills. Users can adjust the LEVEL at any time during the workout to increase or decrease intensity of the hills.

Single Hill: **

WORKLOAD increases to a maximum at the mid-point of the workout, then decreases to the finish to simulate one big hill.

Random Hills: **

A WORKLOAD profile that changes to simulate random hills. Adjust the LEVEL at any time during the workout to increase or decrease the intensity of the hills.

Glute Buster: *

Changing WORKLOAD focuses on intense glute muscle use. For an added challenge, users can reverse the stride motion periodically.

CHAPTER 4: PROGRAMMING & OPERATION

PROGRAM DESCRIPTIONS (CONTINUED):

Calorie Goal: **

This workout allows users to choose the number of calories they wish to burn within a specified workout time. The WORKLOAD will adjust automatically to attain this goal.

Cardio Challenge: *

WORKLOAD and suggested PACE (RPM) increase to a maximum at the mid-point of the workout, then decrease to the finish.

Walk & Run Intervals: *

This workout uses PACE SETTER to suggest walking then running intervals in 1-minute segments. WORKLOAD can be adjusted throughout workout.

Pace Intervals: *

This workout suggests PACE (RPM) intervals in 1-minute segments. The PACE SETTER shows the target pace along with the user's actual pace (RPM) throughout the workout.

Pace Ramp: *

This workout suggests PACE (RPM) increases to a maximum at the mid-point of the workout and then decreases to the finish. The PACE SETTER shows the user's target pace throughout the workout.

Leg Shaper: *

A workout that suggests PACE changes to work the leg muscles with added intensity. Reverse stride occasionally for an added challenge.

Distance Workouts:

Choose from common distance workouts - 5k **, 10k **, 2 mile* or 4 mile*

Saved Workouts: *

Access to previously saved workouts.

Custom Ultra: *

If users are having trouble finding a workout that fits their specific needs, try setting up the Custom Ultra! This completely customizable workout setup allows WORKLOAD and PACE SETTER interval control as well as the ability to control interval time.

HRC Cruise Control: **

While in any program, Cruise Control will allow the user to set current heart rate as target heart rate by pressing a single button. The Cruise Control program takes control of WORKLOAD to maintain the users target Heart Rate. If Beats Per Minute exceeds the target by more than 12 BPM the workout will end and Cool Down will begin.

CHAPTER 4: PROGRAMMING & OPERATION

PROGRAM DESCRIPTIONS (CONTINUED):

HRC Target: **

Users choose their target heart rate. The workout begins in MANUAL control - gradually increase WORKLOAD until heart rate is within 10 bpm of their target. At this point, the machine takes control of WORKLOAD to maintain the user's heart rate within a few beats of their target.

HRC Weight Loss: *

Based on age, this is a heart rate controlled workout at 65% of the user's maximum heart rate. This creates efficient fat burning without overtraining. The workout begins in MANUAL control - gradually increase WORKLOAD until heart rate is within 10 bpm of the user's target. At this point the machine takes control of WORKLOAD to maintain the user's heart rate within a few beats of their target.

HRC Aerobic: *

Based on age, this is a heart rate controlled workout at 80% of the user's maximum heart rate. This keeps them in the optimum aerobic training range to improve cardio fitness. The workout begins in MANUAL control – users should gradually increase WORKLOAD until their heart rate is within 10 bpm of their target. At this point the machine takes control of WORKLOAD to maintain the user's heart rate within a few beats of their target.

HRC Intervals: *

Intervals of WORK and REST determined by target heart rate. The workout begins in MANUAL control –users should gradually increase WORKLOAD until their heart rate is within 10 bpm of their target. At this point, the machine takes control of WORKLOAD to maintain the user's heart rate within a few beats of their target. The rest segment will reduce to 65% intensity of work segment.

Fitness Test: *

A fitness test used to estimate the user's VO2 max.

Cardio 360™:**

A random cycle of Cardio 360™ exercises for a great total-body workout.

Cardio 360™ Quick Start: **

Get right into a pre-set 20-minute workout designed to shape and tone every major muscle group.

Cardio 360™ Arm Sculptor: **

Users challenge their upper body and core in this 10-minute, 3-motion program, and follow along at their own intensity.

Cardio 360™ Leg Shaper: **

Users tighten and tone their legs and glutes, changing resistance on the fly.

Cardio 360™ Custom: **

Users can modify and maximize their workout to its fullest potential. Cardio360 Custom lets users build a personalized routine, choosing their favorite Cardio360™ motions and lengths of time. Then save their set-up for next time.

CHAPTER 4A: ESCALATE⁹ OPERATION

ESCALATE⁹ OVERVIEW:



CHAPTER 4A: ESCALATE⁹ OPERATION

ESCALATE⁹ OVERVIEW (CONTINUED):

LCD Display:

Used to monitor or control a work out and feature navigation.

Selection Buttons:

Used to navigate menus and make selections via the LCD Display.

Workload Keys:

Manually increases or decreases the workout intensity.

Start:

Allows the user to begin a Quick Start workout or preset workout.

Reading Rack:

A ledge on the console can be used to hold a book, magazine, e-reader, or tablet computer during a workout.

USB Port:

Allows users to export workout data to an external USB drive or update the console software.

Numeric Keypad:

A small panel of keys on the console that allow the user to quickly enter numeric data.

Headphone Jack:

Standard 3.5mm audio jack used to connect headphones to the console during media playback.

30 Pin iPod[®] Connector:

Standard 30 pin iPod connector used to connect an iPod to the console.

Warning Decal:

Important safety information for users to review prior to using the equipment.

Stop:

Stops/Pauses a workout. Press and hold this key for five seconds to reset the unit.

CHAPTER 4A: ESCALATE⁹ OPERATION

CONSOLE NAVIGATION:

Home Screen:

The Home Screen is displayed on the console when there is no workout in progress. From this screen the user is able to select from various options to begin a workout.



A) Cardio 360™ Quick Start

Starts a 20 minute Cardio 360™ workout in which the user controls the workout intensity.

B) Workout Finder

Displays preset workouts categorized by goal focus categories.

C) Quick Start

Starts a Quick Start workout in which the user controls all settings until the workout is ended by pressing Stop or Cool Down.

CHAPTER 4A: ESCALATE⁹ OPERATION

CONSOLE NAVIGATION (CONTINUED):

Selecting a Preset Workout:

Preset workouts are accessed by selecting Workout Finder from the home screen. To view the workouts in a category, select the category (A) by using the Scroll Selection Buttons (B) and then press the Next Selection Button (C).

*Press and hold the Next Selection Button to return to the previous screen.

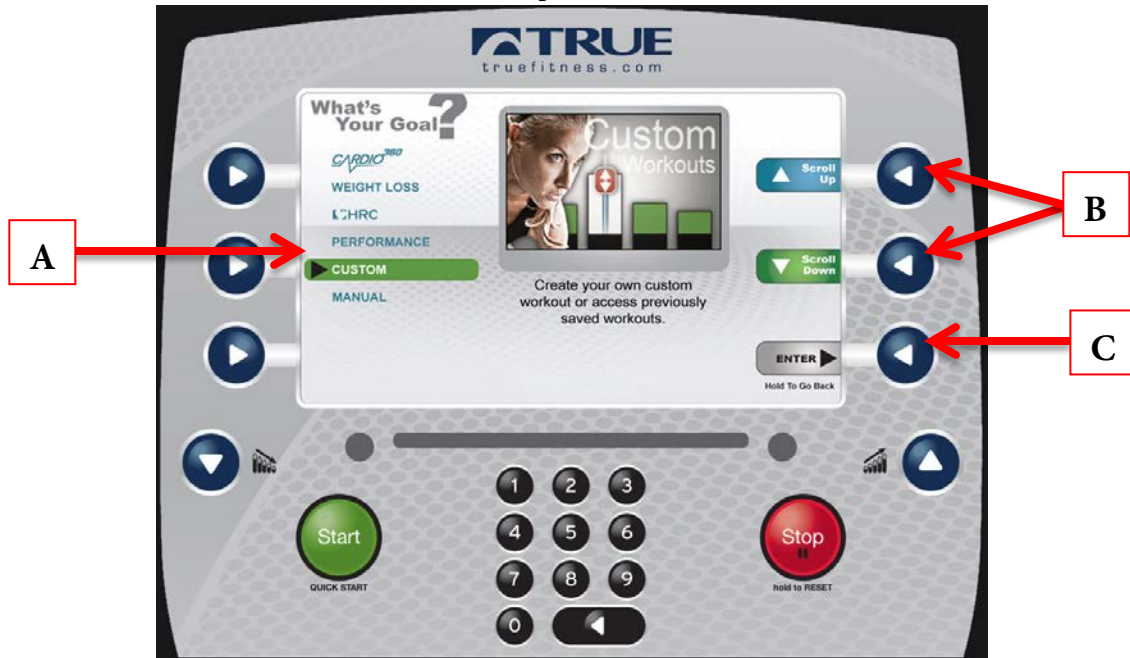

Workout Data Entry Screens:

These screens allow users to input their personal information or workout goals prior to beginning a workout. To set a value, press the Selection Button for the value you wish to change (A) and use the Workload Keys (B) to adjust the value to the desired setting. Users may also manually enter a value using the Numeric Keypad (C).

*Workout Data Entry Screens vary by program selection.

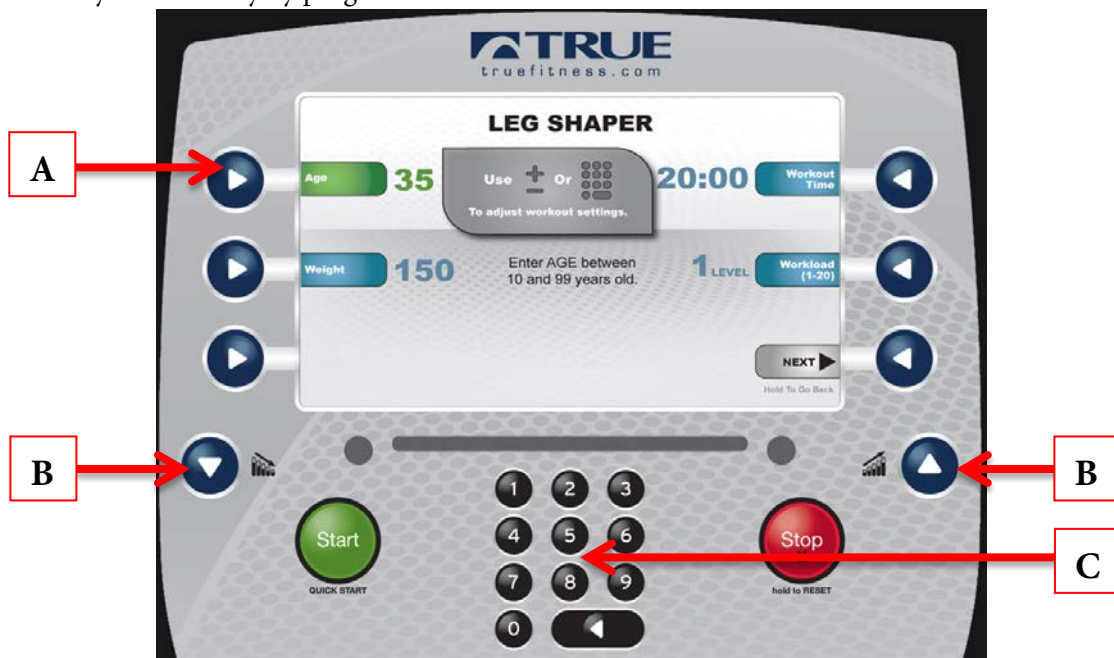

CHAPTER 4A: ESCALATE⁹ OPERATION

CONSOLE NAVIGATION (CONTINUED):

Workout Data Screens:

During any workout a Workout Data Screen will be displayed to give the user a comprehensive visual overview of their current workout data.

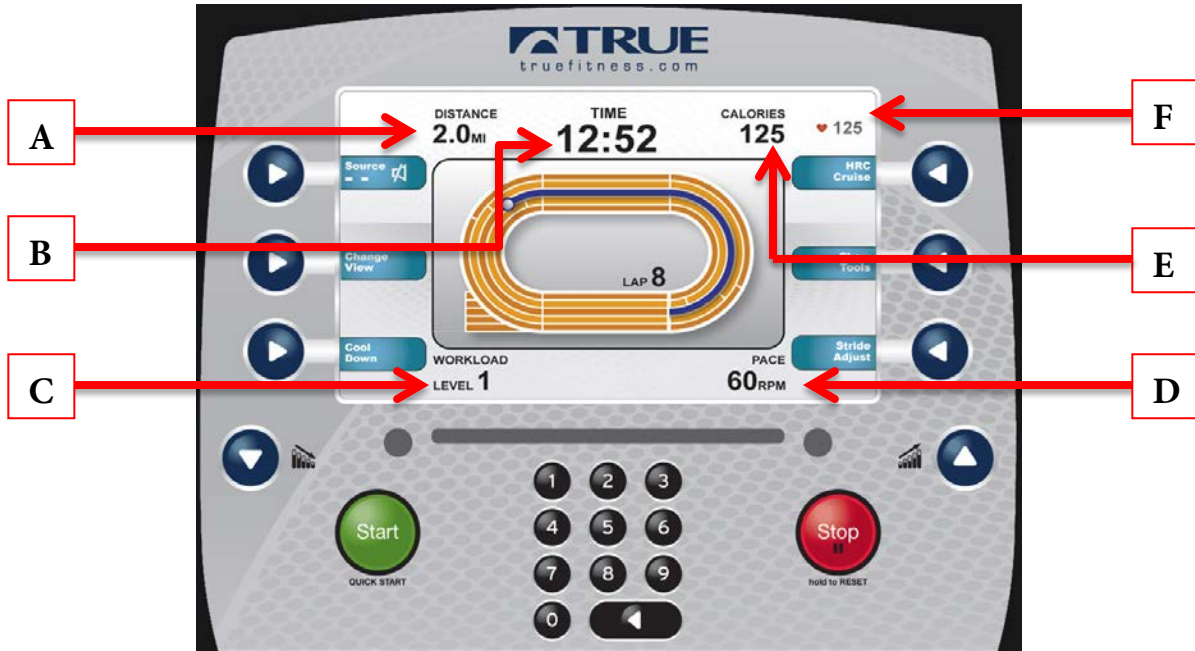

A) Custom Data Display #1:

By Default, this display will show the distance for the current workout. Users can also choose custom data points to be seen in this display.

*See Workout Data Screen Controls; E) Show Tools section below.

B) Time:

Displays the time elapsed for the current workout.

C) Workload:

Shows the current workload level.

D) Pace:

Displays the current pace of a workout.

E) Custom Data Display #2:

By Default, this display will show the calorie count for the current workout. Users can also choose custom data points to be seen in this display.

*See Workout Data Screen Controls; E) Show Tools section below.

F) Heart Rate:

Shows the user's heart rate in a digital beats per minute (bpm) readout.

CHAPTER 4A: ESCALATE⁹ OPERATION

CONSOLE NAVIGATION (CONTINUED):

Workout Data Screen Controls:

The Workout Data Screens contain various controls that allow users to adjust workout settings and to customize their overall workout experience. These controls are accessed by pressing the Selection Button for the control they wish to use.



A) Change View:

Switches between the available Workout Data Screens.

B) Cool Down:

Pressing this button allows the user to end their current workout with a two minute low intensity cool down period. When Cool Down is activated the unit is in manual mode and the user directly controls all settings.

C) HRC Cruise:

Engages Heart Rate Control to allow the equipment to maintain the user's current heart rate through automatic workload adjustments (when the user is utilizing heart rate monitoring).

CHAPTER 4A: ESCALATE⁹ OPERATION

CONSOLE NAVIGATION (CONTINUED):

D) Source:

Toggles the iPod® audio source on and off (when connected via the 30 pin iPod connector). When the iPod® audio source is selected the user is given control over volume (A) and the ability to skip tracks (B).



E) Show Tools:

Pressing the Show Tools Selection Button (A) will display various options. Pressing the Change Data Selection Button (C) will toggle the data points in Custom Data Display 1(1) between distance and watts. The data points in Custom Data display 2 (2) will toggle between calories and METs. Pressing the Scroll Data Selection button (B) will allow the Custom Data Displays to automatically toggle between data points. Pressing the Unit Selection Button (D) will change the units displayed between English and Metric.



CHAPTER 4A: ESCALATE⁹ OPERATION

CONSOLE NAVIGATION (CONTINUED):

F) Stride Adjust:

The adjustable stride feature allows users to select a stride length that is comfortable for them by manually adjusting the stride using the adjustment selection buttons (A) or by using the AutoStride™ feature (B), an electronic adjustable stride feature that will assist you in finding the perfect stride based on your body's natural movement at various speeds



Workout Summary Screen:

At the end of a workout the Summary Screen will display an overview of the workout data. The workout data can be exported to another device by inserting a USB drive into the console's USB port and pressing the Save Selection Button (A) or to return to the home screen press the Home Selection Button (B)



CHAPTER 4A: ESCALATE⁹ OPERATION

CONSOLE NAVIGATION (CONTINUED):

Cardio 360™:

TRUE's unique Cardio 360™ is like having a personal trainer built in to the elliptical, walking users through a full-body workout. In just minutes, users will work their upper-body, lower-body and core. Plus, with the variety that Cardio 360™ brings, it will take the bore out of working out. The program walks users through the various movements they need to do to achieve the complete workout, so all they need to do is commit to stepping on the machine. During a Cardio 360™ program the Cardio360™ Workout Data Screen will guide users through the program.



A) Target Display:

Highlights the muscle groups being targeted during the current workout segment.

B) Workout Directions:

Tells the user what actions to take during a workout segment.

C) Target Display:

Highlights the muscle groups being targeted during the current workout segment.

D) Segment Time Remaining:

Displays the time remaining in the current workout segment.

CHAPTER 4A: ESCALATE⁹ OPERATION

ADVANCED CONSOLE FUNCTIONS:

Entering Service Mode:

Entering Service Mode can be completed by pressing and holding the upper left selection button (A) for 3-5 seconds or until the “Workout Finder” icon (B) blinks. When the “Workout Finder” icon blinks, release the upper right selection button and hold the “Workout Finder” selection button (C) until the service screen displays.



Service Menu:

The first screen displayed after entering service mode is the Service Menu. From this menu technicians can access all of the service mode features by selecting different categories. To select a category use the scroll selection buttons (A) to highlight a category (B). Once a category has been selected, press the enter selection button (C) to Confirm the selection.



CHAPTER 4A: ESCALATE⁹ OPERATION

ADVANCED CONSOLE FUNCTIONS (CONTINUED):

Summary Screen:

The Summary Screen provides an overview of the unit's current settings (values cannot be changed in this screen).



A) Product Model:

The model number that the console is currently configured to.

B) Software Version:

The current version of software that is installed on the console.

C) Units:

Displays the units the console is currently using as default (U.S. or Metric).

CHAPTER 4A: ESCALATE⁹ OPERATION

ADVANCED CONSOLE FUNCTIONS (CONTINUED):

Utilities Menu:

The Utilities Menu allows users to adjust the time and date settings. Press the Enter Selection Button (A) to set the time and date.



Setting Time and Date:

Use the Previous and Next Selection Buttons (A) to highlight the field to be changed. Then use the adjustment selection buttons (B) to adjust the selected value. Once all adjustments have been made, press the Save Selection Button (C) to save the changes (saving changes will cause the console to power cycle) to cancel changes, press the Back Selection Button (D).

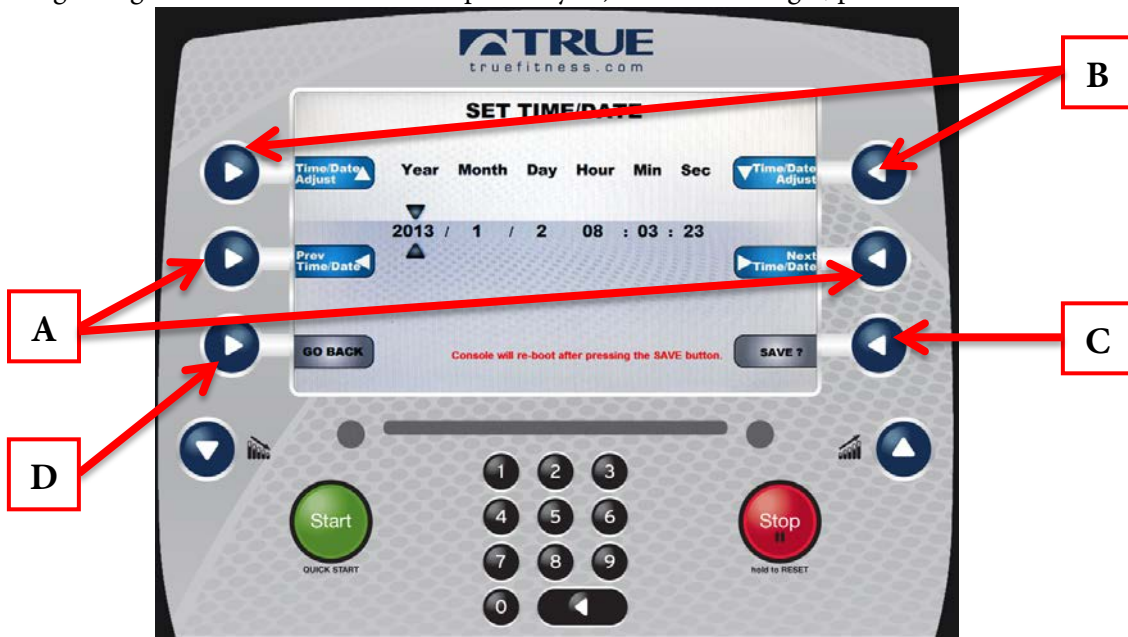

CHAPTER 4A: ESCALATE⁹ OPERATION

ADVANCED CONSOLE FUNCTIONS (CONTINUED):

Demo Mode:

Demo mode is intended for use by sales professionals and should not be used in a home environment.

Diagnostics Menu:

The Diagnostics menu will display the unit's current usage data including total distance, in miles, that the unit has traveled as well as the total time, in hours, that the unit has been in use.



Statistics:

The Statistics Menu is not currently used.



CHAPTER 4A: ESCALATE⁹ OPERATION

ADVANCED CONSOLE FUNCTIONS (CONTINUED):

Options Menu:

The options menu contains 5 Settings with various options available for each. To navigate the options menu, use the scroll selection buttons (A) to highlight the option to be changed (B) and use the + and - Selection Buttons (C) to adjust the options. Once the changes are complete, press the save selection button (D) to save changes or press the Exit Selection Button to exit without saving.



Units:

Choose how the workout data is displayed by default.

Heart Rate Priority:

Determines the order in which the unit reads heart rate data.

Sleep Mode:

The amount of time the unit can be idle before entering sleep mode. By choosing the “Off” setting, the unit will remain powered.

Pause Time:

This setting will limit the amount of time that a workout can be paused before it automatically ends. By choosing the “Off” option, the unit will remain paused until the user resumes or ends the workout.

Sound:

Toggles the unit sounds on or off.

CHAPTER 4B: EMERGE OPERATION

EMERGE OVERVIEW:



CHAPTER 4B: EMERGE OPERATION

EMERGE OVERVIEW (CONTINUED):

LED Displays:

Used to monitor or control a work out and for feature navigation.

Workload Keys:

Manually increases or decreases the workout intensity.

Start:

Allows the user to begin a Quick Start workout or preset workout.

Workout Finder:

Pressing this button scrolls through available workouts. When the desired workout is displayed, the user must press start to begin the workout.

Change Display:

Toggles the data in the upper LED display between available options.

Reading Rack:

A ledge on the console that can be used to hold a book, magazine, e-reader, or tablet computer during a workout.

Warning Decal:

Important safety information for users to review prior to using the equipment.

Target HRC:

Starts a Target HRC workout.

*See Program Descriptions Section

Enter:

Press this key to confirm a selection in a preset workout.

HRC Cruise Control:

Engages Heart Rate Control to allow the equipment to maintain the user's current heart rate through automatic workload adjustments (when the user is utilizing heart rate monitoring).

Numeric Keypad:

Highlights the muscle groups being targeted during a Cardio 360™ workout segment.

Cardio 360™ Quick Start:

Begins a Cardio 360™ Quick Start Program

*See Program Descriptions Section

CHAPTER 4B: EMERGE OPERATION

EMERGE OVERVIEW (CONTINUED):

Stride Keys:

Allow the user to adjust the stride length of the unit.

AutoStride™

An electronic adjustable stride feature that will assist users in finding the perfect stride based on their body's natural movement at various speeds.

Lower LED Display:

Displays the workout profile of the current program.

Upper LED Display:

Shows the workout data of the program in progress in four value displays.

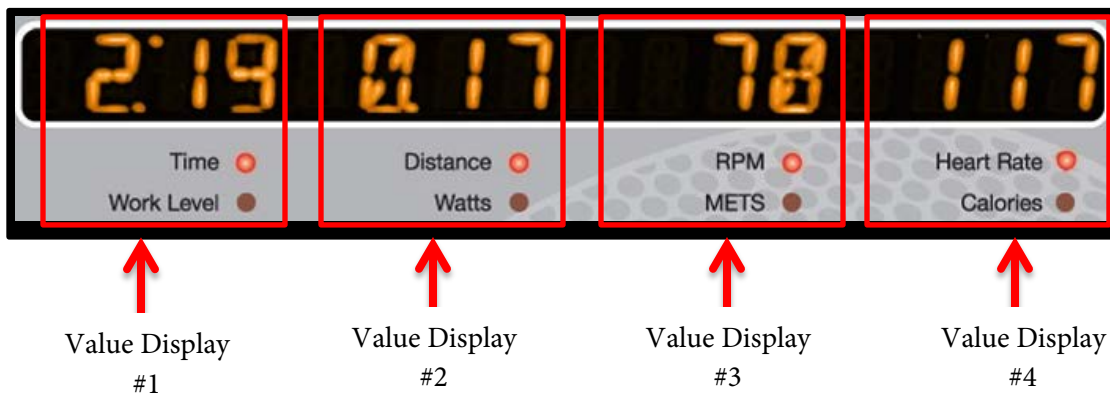

	Value Display #1	Value Display #2	Value Display #3	Value Display#4
Standard Value	<i>Time</i> – The amount of time remaining in the workout.	<i>Distance</i> – An estimate of how far the user has traveled .	<i>RPM</i> –The users pedal cadence.	<i>Heart Rate</i> – Beats per minute display of the user’s heart rate (when using heart rate monitoring).
Value When CHANGE DISPLAY Button is Pressed	<i>Work Level</i> – The selected workload level.	<i>Watts</i> – The amount of mechanical power the unit is receiving from the user.	<i>METS</i> – The user’s metabolic equivalent.	<i>Calories</i> – an estimate of the calories burned. *The estimate does not include the user’s basal metabolic rate.

CHAPTER 4B: EMERGE OPERATION

CONSOLE NAVIGATION:

Selecting a Preset Workout:

To begin a preset workout, press the Workout Finder button (A) until the desired program is shown in the Upper LED Display (B) and then press the Enter button (C).

*To begin a Target HRC Workout, press the HRC Cruise Control button (D) followed by the Enter button (C)

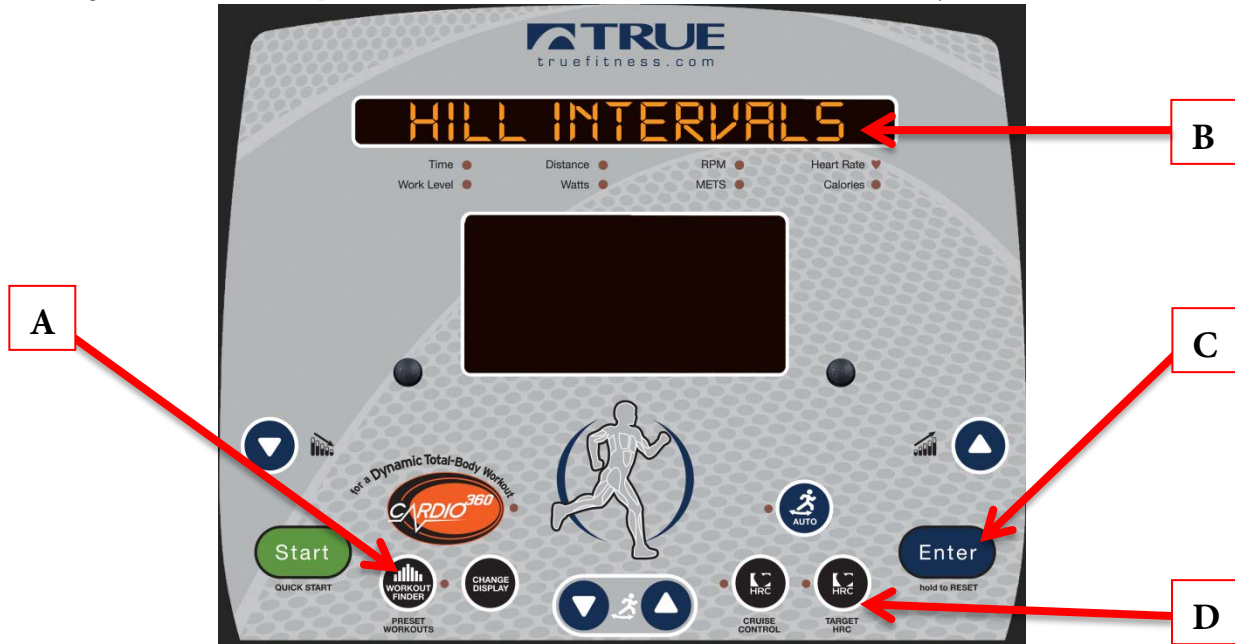

Workout Data Entry:

Before beginning a preset workout, the console will ask the user for information in order to give more accurate workout data. To adjust the Data Value (A), use the Up and Down Workload Keys (B). Once the desired value is displayed, press Enter (C) to move to the next Data Value. Once all data has been entered press Start (D) to begin the workout.



CHAPTER 4B: EMERGE OPERATION

CONSOLE NAVIGATION (CONTINUED):

Workout Summary:

Once a workout has ended the console will display a workout Summary which will give the user an overview of their workout which includes; Time, Average Heart Rate, Max Heart Rate, Average RPM, Max RPM, Distance and Calories. To Clear the Summary and return to the home screen press and hold the Enter button (A).

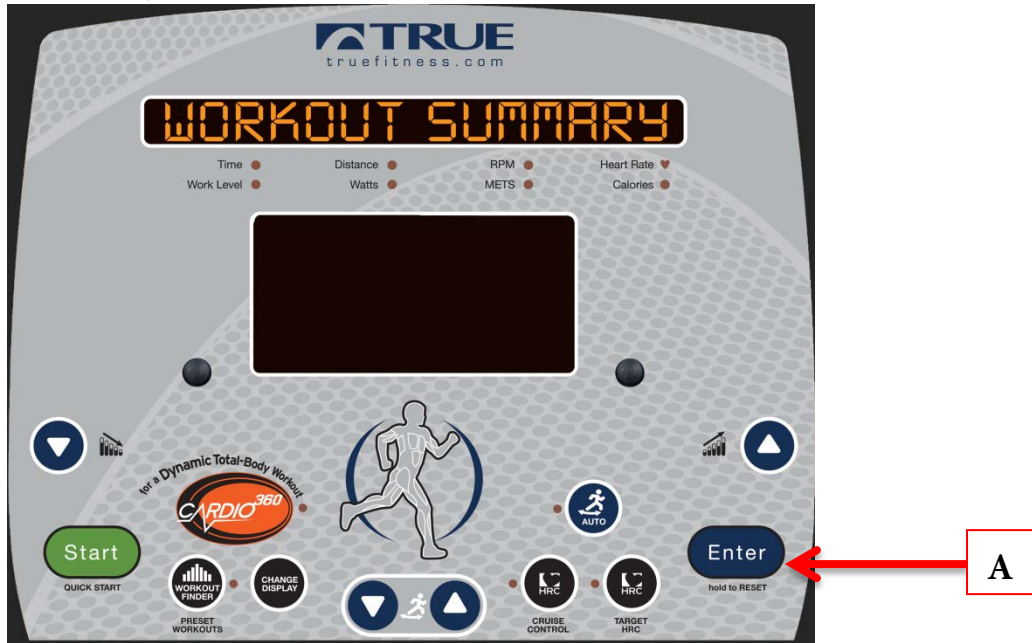

Cardio 360™:

TRUE's unique Cardio 360™ is like having a personal trainer built in to the elliptical, walking users through a full-body workout. In just minutes, users will work their upper-body, lower-body and core. Plus, with the variety that Cardio 360™ brings, it will take the bore out of working out. The program walks users through the various movements they need to do to achieve the complete workout, so all they need to do is commit to stepping on the machine. To Begin a Cardio 360™ workout, press the Cardio 360™ Quickstart Key (A) or use the workout finder (B) to select a Cardio 360™ preset workouts.



CHAPTER 4B: EMERGE OPERATION

ADVANCED CONSOLE FUNCTIONS:

WARNING:

Misconfiguration of the console may cause damage to the unit and void the manufacturer warranty. If necessary, please contact TRUE Fitness Technical Support at 800-883-8783 for assistance.

Entering Diagnostics Mode:

With the console powered up

Press and hold the + WORKLOAD key for 10 seconds or until the console beeps. NOTE: If the sound is turned off no beep will be emitted from the console.

Continue holding the +WORKLOAD key and simultaneously press the ENTER key.

Use the + or - WORKLOAD keys to select SETUP then press ENTER

Use the + or - WORKLOAD keys to scroll through the available options then press ENTER to select

Use the + or - WORKLOAD keys to adjust options then press ENTER

Use the + or - WORKLOAD keys to scroll to the end of the options list then press ENTER to Exit.

Available options:

- Display Units (English, German, French or Spanish language)
- Time (Sets the default program time)
- Weight (Sets the default user weight)
- Pause Duration (Time the console will wait before resetting when in a program)
- Sleep (Sets the time the unit sit unused before the console goes into sleep mode)
- Sound (on or off)
- RPM (Not used)

CHAPTER 5: CARE & MAINTENANCE

CARE & MAINTENANCE:

It is important to perform the minor maintenance tasks described in this section. Failure to maintain the elliptical as described here could void the TRUE Fitness Warranty. To reduce the risk of electrical shock, always unplug the unit from its power source before cleaning or performing any maintenance tasks.

Inspection:

TRUE Fitness is not responsible for performing or scheduling regular maintenance or inspections.

Users should inspect the elliptical daily. Look and listen for slipping belts, loose fasteners, unusual noises, worn or frayed power cords, and any other indications that the equipment may be in need of service. If any of these are noticed, obtain service. Do not attempt to use the elliptical until proper service has been performed or damaged parts have been replaced.

Important:

If you determine that the elliptical needs service, make sure that the elliptical cannot be used inadvertently. Turn the unit off, and then unplug the power cord from its power source. Make sure other users know that the elliptical needs service.

To order parts or to contact a TRUE Authorized Service representative, please visit www.truefitness.com.

CLEANING THE EQUIPMENT:

After Each Use:

Use GymWipes™ Antibacterial wipes or spray a solution of 30 parts water to 1 part mild detergent to dampen a soft cloth and wipe all exposed surfaces.

Use a LCD/screen cleaner or spray a solution of 1 part 91% isopropyl alcohol and 1 part water to dampen a soft cloth and wipe the surface of the console. This helps remove fingerprints, dust, and dirt

Weekly:

Vacuum any dust or dirt that might have accumulated under or around the elliptical or any cover vents.

*Clogged air vents can prevent adequate cooling, causing a shortened life.

CAUTION:

Do not use any acidic cleaners. Doing so will weaken the paint or powder coatings and may void the TRUE Fitness Warranty. Never pour water or spray liquids on any part of the elliptical. Allow the elliptical to dry completely before using. Frequently vacuum the floor underneath the unit to prevent the accumulation of dust and dirt, which can affect the smooth operation of the unit. Use a soft nylon scrub brush to clean the foot pads. Most of the working mechanisms are protected inside the covers and base of the elliptical. However, for efficient operation, the elliptical relies on low friction. To keep the friction low, the unit's belts, foot pads, pedals or pedal arms, and internal mechanisms must be as clean as possible.

CHAPTER 5: CARE & MAINTENANCE

LEVELING THE UNIT:

The elliptical has adjustable feet. Make sure that the running surface is level. If the elliptical is placed on an uneven surface, adjusting the feet can help, but may not compensate for extremely uneven surfaces.



⚠ CAUTION:

If the elliptical is not level the user may experience knocking or clicking sounds.

OTHER SCHEDULED PREVENTIVE MAINTENANCE:

TRUE recommends that quarterly scheduled maintenance be performed by a qualified service technician. Please contact your dealer or visit www.truefitness.com to contact a local TRUE authorized service technician.

Scheduled Preventive Maintenance:

- Record time, distance and hours from the console.
- Check error log in console.
- Remove shroud covers and vacuum any debris out of the speed sensor, control electronics and moving parts.
- Move unit and vacuum underneath.
- Check belt tension and tracking.
- Inspect all fasteners.
- Inspect all electrical connections.
- Inspect all components for abnormal or premature wear.

⚠ CAUTION:

Use only TRUE Fitness certified service providers.

LONG TERM STORAGE:

When the elliptical is not in use for any length of time, turn it off. Make sure that the power cord is unplugged from the power source and is positioned so that it will not become damaged or interfere with people or other equipment.

Storing the Chest Strap:

Store the chest strap in a place where it remains free of dust and dirt such as, in a closet or drawer. Be sure to protect the chest strap from extremes in temperature. Do not store it in a place that may be exposed to temperatures below 32° F (0° C). To clean the chest strap, use a sponge or soft cloth dampened in mild soap and water. Dry the surface thoroughly with a clean towel.

CHAPTER 6: CUSTOMER SERVICE

CONTACTING SERVICE:

TRUE Fitness recommends that you gather the serial number, model number, and a brief description of the reason for the request. After information has been gathered you may choose to contact your selling dealer or local service company to set an appointment. (If you are not familiar with who is in your area, you may visit our website at www.truefitness.com and use our dealer locator to obtain the contact information for the closest dealer).

You may also contact TRUE Fitness' customer support team by calling 800.883.8783 or e-mailing us at service@truefitness.com Monday – Friday during normal business hours.

TRUE FITNESS SERVICE DEPARTMENT

865 HOFF ROAD

ST. LOUIS, MO 63366

1.800.883.8783

HOURS OF OPERATION: 8:30 A.M. - 5:00 P.M. CST

E-MAIL: service@truefitness.com

CONTACTING SALES:

Interested in TRUE Products? Please contact us with any sales or product inquiries so that we may direct you to the appropriate sales representative to answer your questions.

TRUE FITNESS HOME OFFICE

865 HOFF ROAD

ST. LOUIS, MO 63366

1.800.426.6570

HOURS OF OPERATION: 8:30 A.M. - 5:00 P.M. CST

E-MAIL: sales@truefitness.com

CHAPTER 6: CUSTOMER SERVICE

REPORTING FREIGHT OR PARTS DAMAGE:

Unfortunately, sometimes materials can be damaged during shipment. If materials are damaged during shipment, please follow the guidelines below to determine the appropriate process for you to follow in case of damages.

Severe Damage:

Obvious damage to external packaging / internal product. Please **refuse** the shipment and it will be returned to TRUE Fitness by the carrier. Contact the TRUE Fitness customer support team by calling 800.883.8783 or sales support team by calling 800.426.6570 Monday-Friday during normal business hours to notify us that the shipment has been refused. Once we have received the damaged shipment, a replacement shipment will be sent to you. Only refuse the damaged piece if the shipment is multiple boxes.

Slight Damage:

The box may have minimal damages and you are not sure if the actual product is damaged or not. You **must** sign the bill of lading as damaged when accepting the shipment. Once you have opened the box and you have determined something is indeed damaged please gather the serial number, model number, description and photos of damages. Please make sure the photos include the damaged product as well as the damaged box the product arrived in. Contact the TRUE Fitness customer support team by calling 800.883.8783 or sales support team by calling 800.426.6570 Monday-Friday during normal business hours.

Concealed Damage:

You may receive a shipment that looks intact and discover once the box has been opened that there are hidden damages. Please notify the carrier **immediately**. We will not be able to file a claim if the carrier is not notified in a timely manner. Once you have called the carrier you will need to gather the serial number, model number, description and photos of damages. Contact the TRUE Fitness customer support team by calling 800.883.8783 or sales support team by calling 800.426.6570 Monday-Friday during normal business hours.

CHAPTER 7: ADDITIONAL INFORMATION

TROUBLESHOOTING GUIDE:

This troubleshooting guide is intended to assist in diagnostics only and is not all inclusive. Technical specifications, error codes and programming are subject to change without notice. TRUE accepts no liability for any damage or loss suffered by persons whom rely wholly or in part on any description or statement contained within this manual. Please visit www.truefitness.com to obtain the most recent version of all manuals and contact the TRUE Service Department at 800-883-8783 for assistance with troubleshooting and diagnostics.

Malfunction	Possible Cause	Corrective Action
No Power	Unit is turned off	Verify the On/Off switch is at the ON position (if applicable)
	Damaged power cord	Replace power cord (if applicable)
	Power cord not fully seated in socket	Inspect power connection at the unit and outlet
	No power at wall outlet	Use a voltmeter to verify power at wall outlet
	Motor control board damaged	Contact True Fitness Customer Service Department
Unit resets or pauses randomly	Damaged power cord	Replace power cord
	Power cord not fully seated in socket	Inspect power connection at the unit and outlet
	Insufficient power	Verify output voltage from 20A outlet with a voltmeter
	Error code is displayed on console	Contact True Fitness Customer Service Department
	Speed sensor out of alignment	Contact True Fitness Customer Service Department
	Pinched or loose main communication cable	Contact True Fitness Customer Service Department
Resistance hesitates or slips when pedaling	Loose belt tension	Contact True Fitness Customer Service Department
Rubbing or knocking sound from unit when in operation	Uneven floor	Adjust equipment with leveling feet.
	Loose hardware	See Chapter 5: inspections
	Loose Pedal	See Chapter 5: inspections
	Bearings may be damaged	Contact True Fitness Customer Service Department
	Brake assembly may be damaged	Contact True Fitness Customer Service Department
	Drive belt may be misaligned	Contact True Fitness Customer Service Department
Time, Distance and calories not calculating	Misaligned or damaged speed sensor	Contact True Fitness Customer Service Department
	Missing or damaged speed sensor magnet	
	Damaged or disconnected data cable	
	Upper console malfunction	

CHAPTER 7: ADDITIONAL INFORMATION

TROUBLESHOOTING GUIDE (CONTINUED):

Malfunction	Possible Cause	Corrective Action
Heart rate is displaying erratically or not displaying	Transmitter belt contacts are not making good contact with the skin	Readjust the transmitter belt so that it is in full contact with the skin
	Contacts on the transmitter belt are not moist	Moisten the contacts on the transmitter belt
	Transmitter belt is not within 3 feet (1 meter) of the heart rate receiver	Adjust your position on the belt so that you are within 3 foot (1 meter) of the console
	Transmitter belt is not the correct frequency or is encoded	Polar equip or compatible receiver use 4.8kHz un-encoded receiver
	The battery inside the transmitter belt is depleted	replace the transmitter belt with a compatible transmitter belt
	Another user wearing a compatible transmitter strap is within 3 foot (1 meter) of the unit	Move the units so that there is more space in-between units
	Environmental interference from high voltage power lines	Move the unit to another position within the room or move the cause of the interference until heart rate reading are stable. If the probable source of interference is plugged into the same outlet move the suspect source to another outlet.
	Environmental interference from computers	
	Environmental interference from motor driven appliances	
	Environmental interference from cell or cordless phone	
Environmental interference from Wi-Fi router		

Fault Code	Definition	Corrective Action
Serial Error	Loss of communication between the upper board and brake motor.	Power cycle unit
		Contact True Fitness Customer Service Department
Motor Error	No movement detected from the brake motor.	Power cycle unit
		Contact True Fitness Customer Service Department

CHAPTER 7: ADDITIONAL INFORMATION

TRUE RESIDENTIAL



Premium Fitness Equipment Since 1981



The ES700 elliptical is engineered with commercial-grade materials and boasts a sleek, dynamic design made to inspire and engage. Tone your muscles and increase your endurance with a cross-trainer designed to give users the most natural movement available on an elliptical. The ES700 delivers a comfortable, low-impact, and safe total body workout unlike any other on the market. TRUE's ES700 is equipped with all of the user-friendly interactive and patented TRUE features you need for your home fitness routine. Make the ES700 elliptical your own with multiple console options.



ES700

CHAPTER 7: ADDITIONAL INFORMATION



TRUE

R E S I D E N T I A L

ES700 ELLIPTICAL

TECHNICAL SPECIFICATIONS	Power Source	110V/15A
	Cord Length	8' (2.4M)
	Drive System	Core Drive™
	Total Body Workout	Cardio 360™
	Resistance Source	Eddy Current Brake
	Maximum Workload	300 Watts
	Frame Construction	Robotically Welded Heavy-Gauge Steel
	Stride Length	16" to 27"; 1/2" Increments (41 cm to 69 cm; 1 cm increments)
	Auto Stride™	Yes (1" Increments)
	Footpad	Orthopedic Soft Step Cushioned Anti-Fatigue Material (removable)
	Exercise Arms	Ergonomic Multi-Grip Handle
	Handrail Design	Extended Handrails with Molded Rubber, Moisture Resistant Grips
	Side Step Design	Non-Slip Rubber with Textured Pattern
	Contact Heart Rate Monitoring	Yes
	Wireless Heart Rate Monitoring	Polar® Compatible
AVAILABLE CONSOLES		Escalate ⁹ , Emerge
Cardio 360™	Upper Body Isolation	Yes
	Lower Body Isolation	Yes
	Total Body	Yes
	Cardio 360™ Workouts	Yes
SAFETY	Side Steps	Standard
	Extended Handrails	Standard
	TRUE Lock™	Standard
REGULATORY APPROVALS		ETL UL1647, CSA
EXTRAS	Accessories	Water Bottle Holder, Accessory Tray, Over Molded Reading Rack/Tablet Holder
PHYSICAL SPECIFICATIONS	Footprint	49"L x 32.5"W (124 cm x 83 cm)
	Active Footprint	75"L x 32.5"W (191 cm x 83 cm)
	Q-Factor	2" (5 cm)
	Machine Weight	281 lbs. (127 kg)
	Maximum User Weight	350 lbs. (159 kg)
	Step-Up Height	7" (18 cm)
	Portability	2 Front Transport Wheels & Removable Handles
WARRANTY	Warranty Type	Residential
	Frame	Lifetime
	Parts	7 Years
	Labor	1 Year

Warranties outside the U.S. and Canada may vary - Please contact your dealer for details. Specifications subject to change without notice.



iPod is a trademark of Apple Inc., registered in the U.S. and other countries.
 "Made for iPod" means that an electronic accessory has been designed to connect specifically to iPod and has been certified by the developer to meet Apple performance standards. Apple is not responsible for the operation of this device or its compliance with safety and regulatory standards.

BROCH14R07

CHAPTER 7: ADDITIONAL INFORMATION



RESIDENTIAL LIMITED WARRANTY ES700 ELLIPTICALS

Save Time and Register Online!
Activate Multiple Warranties at www.truefitness.com

All TRUE® Fitness products are distributed by TRUE and are warranted to the original registered product purchaser and the parts of the TRUE product (the "Product") listed below, under normal use and service, shall be free of manufacturing defects in workmanship and materials only for the period of time beginning from the original date of purchase set forth below:

Frame*	Lifetime
Parts Electrical Wear Items Cosmetics	7 Years 7 Years 6 Months
Labor Parts Cosmetics	1 Year 6 Months
iPod® Connectivity Headphone jack, connector & USB Port	6 months parts, no labor

NOTE: Warranty valid for USA and Canada only.

Frame: The frame is warranted for defects in material and workmanship for as long as the original purchaser owns the Product. The frame is warranted for labor and freight (for parts shipped from TRUE) for one year from date of purchase. * This limited warranty on structural frame does not include paint or coatings.

Parts: The elliptical electrical parts and wear items are warranted for defects in material and workmanship for seven years with one year labor warranty. This limited warranty does not cover damage or equipment failure resulting from or caused by improper assembly/installation, failure to follow instructions and warnings in owner's manual, accident, misuse, abuse, unauthorized modification, or failure to provide reasonable and necessary maintenance. *TRUE Fitness shall not warrant the performance of the heart rate system on its products, as the heart rate system performance varies, based on user's physiology, age, method of use and other factors. * This limited warranty shall not apply to software version upgrades.

Cosmetics: The elliptical cosmetic parts are warranted for defects in material and workmanship for six months with labor warranty to match the parts warranty period. This limited warranty does not cover damage or equipment failure

resulting from or caused by improper assembly/installation, failure to follow instructions and warnings in owner's manual, accident, misuse, abuse, unauthorized modification, or failure to provide reasonable and necessary maintenance. This limited warranty will apply to but may not be limited to paint/coatings, covers/caps, badges, overlays, pedal, pedal strap and seat cushions.

iPod® Connectivity: iPod connectivity elements; headphone jack, connector and USB Port are warranted for defects in material and workmanship for 6 months with no labor warranty.

Labor: Labor is covered for a period of one year from the date of purchase unless otherwise expressed within this limited warranty as long as a TRUE authorized service provider performs the service. Service that requires over 50 miles of travel may be subject to additional charges. Reasonable and necessary maintenance guidelines can be found in the owner's manual.

Claims Procedure: TRUE Limited Warranty service may be obtained by contacting the authorized TRUE dealer from whom the Product was purchased. If the dealer from whom the Product was purchased is no longer an authorized TRUE dealer, then TRUE Limited Warranty service may be obtained by contacting TRUE directly at:

TRUE Fitness, Service Department
865 Hoff Road, St. Louis, MO 63366
1.800.883.8783
Hours of operation 8:30am - 5:00 pm CST

The above Limited Warranty is subject to and will be in accordance with the conditions set forth below:

1. This Limited Warranty can be processed only if the Warranty Registration Form is completed on-line; or if the attached form is filled in, signed by the original purchaser and mailed to TRUE within 30 days of purchaser's receipt of this Product. The serial number must be intact on the Product for this Limited Warranty to be valid.
2. This Limited Warranty applies to the product only while the Product remains in the possession of the original purchaser and is not transferable.
3. This Limited Warranty becomes VALID ONLY if the Product is initially assembled/installed by a TRUE authorized dealer/ technician (if anyone other than a TRUE authorized dealer/ technician initially assembles and installs the Product, this Limited Warranty will be void unless the written authorization of TRUE is first obtained).

truefitness.com / 800.426.6570 / 1.636.272.7100

CHAPTER 7: ADDITIONAL INFORMATION



RESIDENTIAL LIMITED WARRANTY ES700 ELLIPTICALS

Save Time and Register Online!

Activate Multiple Warranties at www.truefitness.com/support

4. This Limited Warranty does not cover damage or equipment failure resulting from or caused by improper assembly/ installation, failure to follow instructions and warnings in owner's manual, accident, misuse, abuse, unauthorized modification, or failure to provide reasonable and necessary maintenance (as referenced in the owner's manual.)

5. This Limited Warranty applies only to the cost of repair or replacement of parts and does not include labor (beyond the above warranty period), transportation, service, return and freight charges associated there with expressly specified herein.

6. This Limited Warranty shall not apply to: Service calls to correct installation of the equipment or instruction to owners on how to use the equipment; or any labor costs incurred beyond the applicable labor warranty period.

7. This Limited Warranty is in lieu of all warranties, express or implied, and in lieu of all other obligations or liabilities on the part of TRUE, under no circumstances shall TRUE be liable by virtue of this Limited Warranty or otherwise from damage to any person or property whatsoever for any special, indirect, incidental, secondary or consequential losses, damages or expenses in connection with exercise products.

Any implied warranty is limited in duration to the time period covered by the Limited Warranty. Some states do not allow limitations on how long an implied warranty lasts, or the exclusion may not apply to you. This Limited Warranty grants you specific legal rights and you may also have other rights, which vary from state to state.

NOTE TO AUTHORIZED WARRANTY LABOR PROVIDERS:

Warranty labor reimbursement or warranty parts rights may not be transferred to, reassigned to, a third party without the express written consent of TRUE. Even jobbing out warranty labor requires TRUE's written approval.

ELLIPTICAL SERIAL NUMBERS:

The ES700 ellipticals come with two serial numbers; one on the base and one on the display console (see diagram below). The serial number on the base is located on bottom of the crossbar. The console serial number is located on the bottom right side of each console. Please write down your serial numbers below and keep for your records.

CONSOLE SERIAL NUMBER:

BASE SERIAL NUMBER:



SAMPLE SERIAL NUMBER STICKER:

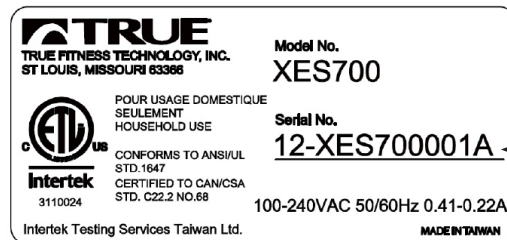

SAMPLE SERIAL NUMBER:

CHAPTER 7: ADDITIONAL INFORMATION



RESIDENTIAL LIMITED WARRANTY ES700 ELLIPTICALS

Thank you for purchasing a TRUE product. To validate the TRUE product warranty the fast and easy way, please go on-line now to truefitness.com/support and register your product. The information you provide will never be distributed to any other individuals or agencies for any purpose. If you prefer to mail your warranty card, have the owner of the product complete the information below and return it to TRUE Fitness within 30 days from the date of equipment installation.

Please Note: Failure to register this product will result in no servicing or authorization of parts to be shipped.

To mail your warranty information, please fill in the information below and mail to: Service Dept., TRUE Fitness, 865 Hoff Road, St. Louis, MO 63366 (or save postage and register online at www.truefitness.com/support)



Residential Warranty Registration

**PLEASE PROVIDE BOTH SERIAL NUMBERS BELOW.
REQUIRED FOR WARRANTY REGISTRATION:**

CONSOLE SERIAL NUMBER:

BASE SERIAL NUMBER:

Model Type: Treadmill Elliptical Bike
 Other

Date of Purchase _____

Purchased From (Dealer Name) _____

First Name _____

Last Name _____

Address _____

City _____ State _____ ZIP _____

Email Address _____

Phone _____

1. Where did you first learn about TRUE?

- a. Dealer b. Website
 c. Advertisement d. Referral
 e. Current Customer f. Other _____

2. The primary user(s) is:

- a. Male b. Female
 c. Both

3. Do you currently belong to a health club?

- a. Yes b. No

4. Your Age Group:

- a. Under 25 b. 25-35
 c. 36-45 d. 46-55
 e. 56-65 f. 65+

5. What was the primary reason you purchased a TRUE product?
(check only one)

- a. Design/Appearance b. Dealer Suggestion
 c. Price/Value d. Ease of Operation
 e. Quality of Construction f. Size
 g. Reputation h. Warranty
 i. Friend/Family Recommendation

6. Do you plan to purchase more fitness equipment in the next 6-12 months?

- a. Yes b. No

7. If you answered "yes" to question 6, what type do you plan to purchase?

- a. Treadmill b. Elliptical
 c. Bike d. Free Weights
 e. Gym f. Other _____

8. What is your annual household income? (optional)

- a. Under \$50,000 b. \$50,000 - \$75,000
 c. \$75,000 - \$100,000 d. \$100,000 - \$150,000
 e. \$15,000+

9. You are a valued TRUE customer and your suggestions allow us to continually improve your experience. Is there anything else you would like us to know? Please explain:

truefitness.com / 800.426.6570 / 1.636.272.7100

CHAPTER 7: ADDITIONAL INFORMATION

TRUE RESIDENTIAL



Premium Fitness Equipment Since 1981



The TRUE ES900 allows you to bring the fitness club experience into your home with commercial quality equipment. The ES900 is our top-of-the-line elliptical cross-trainer, ergonomically engineered to give you a total body workout unlike any other elliptical trainer on the market. With 360° ergonomically engineered rotating handles, TRUE's exclusive Cardio360™ programming, Heart Rate Control, iPod integration, and many more advanced features, the ES900 elliptical is fully loaded with variety and features.



ES900

CHAPTER 7: ADDITIONAL INFORMATION



TRUE RESIDENTIAL

ES900
ELLIPTICAL

TECHNICAL SPECIFICATIONS	Power Source	110V/15A	
	Cord Length	8' (2.4M)	
	Drive System	Core Drive™	
	Total Body Workout	Cardio 360™	
	Resistance Source	Eddy Current Brake	
	Maximum Workload	300 Watts	
	Frame Construction	Robotically Welded Heavy-Gauge Steel	
	Stride Length	16" to 27"; 1/2" Increments (41 cm to 69 cm; 1 cm increments)	
	Auto Stride™	Yes (1" Increments)	
	Footpad	Orthopedic Soft Step Cushioned Anti-Fatigue Material (removable)	
	Exercise Arms	Ergonomically Designed Rotating Handles with Upper-Body Only Capability Height Adjustment	
	Handrail Design	Extended Handrails with Molded Rubber, Moisture Resistant Grips	
	Side Step Design	Brushed Aluminum with Textured Pattern	
	Contact Heart Rate Monitoring	Yes	
	Wireless Heart Rate Monitoring	Polar® Compatible	
AVAILABLE CONSOLES	Available Consoles	Escalate ⁹	
Cardio 360™	Upper Body Isolation	Yes	
	Lower Body Isolation	Yes	
	Total Body	Yes	
	Cardio 360™ Workouts	Yes	
SAFETY	Side Steps	Standard	
	Extended Handrails	Standard	
	TRUE Lock™	Standard	
REGULATORY APPROVALS		ETL UL1647, CSA	
EXTRAS	Accessories	Water Bottle Holder, Accessory Tray, Over Molded Reading Rack/Tablet Holder	
PHYSICAL SPECIFICATIONS	Footprint	49"L x 32.5"W (124 cm x 83 cm)	
	Active Footprint	75"L x 32.5"W (191 cm x 83 cm)	
	0-Factor	2" (5 cm)	
	Machine Weight	288 lbs. (131 kg)	
	Maximum User Weight	350 lbs. (159 kg)	
	Step-Up Height	7" (18 cm)	
	Portability	2 Front Transport Wheels & Removable Handles	
WARRANTY	Warranty Type	Residential	
	Frame	Lifetime	
	Parts	10 Years	
	Labor	1 Year	

Warranties outside the U.S. and Canada may vary - Please contact your dealer for details. Specifications subject to change without notice.



iPod is a trademark of Apple Inc., registered in the U.S. and other countries.
Made for iPod means that an electronic accessory has been designed to connect specifically to iPod and has been certified by the developer to meet Apple performance standards. Apple is not responsible for the operation of this device or its compliance with safety and regulatory standards.

BROCH14R08

trufitness.com | 800.426.6570 | 636.272.7100 ©2013 True Fitness Technology, Inc

CHAPTER 7: ADDITIONAL INFORMATION



RESIDENTIAL LIMITED WARRANTY ES900 ELLIPTICALS

Save Time and Register Online!
Activate Multiple Warranties at www.truefitness.com

All TRUE® Fitness products are distributed by TRUE and are warranted to the original registered product purchaser and the parts of the TRUE product (the "Product") listed below, under normal use and service, shall be free of manufacturing defects in workmanship and materials only for the period of time beginning from the original date of purchase set forth below:

Frame*	Lifetime
Parts Electrical Wear Items Cosmetics	10 Years 10 Years 6 Months
Labor Parts Cosmetics	1 Year 6 Months
iPod® Connectivity Headphone jack, connector & USB Port	6 months parts, no labor

NOTE: Warranty valid for USA and Canada only.

Frame: The frame is warranted for defects in material and workmanship for as long as the original purchaser owns the Product. The frame is warranted for labor and freight (for parts shipped from TRUE) for one year from date of purchase. * This limited warranty on structural frame does not include paint or coatings.

Parts: The elliptical electrical parts and wear items are warranted for defects in material and workmanship for seven years with one year labor warranty. This limited warranty does not cover damage or equipment failure resulting from or caused by improper assembly/installation, failure to follow instructions and warnings in owner's manual, accident, misuse, abuse, unauthorized modification, or failure to provide reasonable and necessary maintenance. *TRUE Fitness shall not warrant the performance of the heart rate system on its products, as the heart rate system performance varies, based on user's physiology, age, method of use and other factors. * This limited warranty shall not apply to software version upgrades.

Cosmetics: The elliptical cosmetic parts are warranted for defects in material and workmanship for six months with labor warranty to match the parts warranty period. This limited warranty does not cover damage or equipment failure

resulting from or caused by improper assembly/installation, failure to follow instructions and warnings in owner's manual, accident, misuse, abuse, unauthorized modification, or failure to provide reasonable and necessary maintenance. This limited warranty will apply to but may not be limited to paint/coatings, covers/caps, badges, overlays, pedal, pedal strap and seat cushions.

iPod® Connectivity: iPod connectivity elements; headphone jack, connector and USB Port are warranted for defects in material and workmanship for 6 months with no labor warranty.

Labor: Labor is covered for a period of one year from the date of purchase unless otherwise expressed within this limited warranty as long as a TRUE authorized service provider performs the service. Service that requires over 50 miles of travel may be subject to additional charges. Reasonable and necessary maintenance guidelines can be found in the owner's manual.

Claims Procedure: TRUE Limited Warranty service may be obtained by contacting the authorized TRUE dealer from whom the Product was purchased. If the dealer from whom the Product was purchased is no longer an authorized TRUE dealer, then TRUE Limited Warranty service may be obtained by contacting TRUE directly at:

TRUE Fitness, Service Department
865 Hoff Road, St. Louis, MO 63366
1.800.883.8783
Hours of operation 8:30am - 5:00 pm CST

The above Limited Warranty is subject to and will be in accordance with the conditions set forth below:

1. This Limited Warranty can be processed only if the Warranty Registration Form is completed on-line; or if the attached form is filled in, signed by the original purchaser and mailed to TRUE within 30 days of purchaser's receipt of this Product. The serial number must be intact on the Product for this Limited Warranty to be valid.
2. This Limited Warranty applies to the product only while the Product remains in the possession of the original purchaser and is not transferable.
3. This Limited Warranty becomes VALID ONLY if the Product is initially assembled/installed by a TRUE authorized dealer/ technician (if anyone other than a TRUE authorized dealer/ technician initially assembles and installs the Product, this Limited Warranty will be void unless the written authorization of TRUE is first obtained).

truefitness.com / 800.426.6570 / 1.636.272.7100

CHAPTER 7: ADDITIONAL INFORMATION



RESIDENTIAL LIMITED WARRANTY ES900 ELLIPTICALS

Save Time and Register Online!

Activate Multiple Warranties at www.truefitness.com/support

4. This Limited Warranty does not cover damage or equipment failure resulting from or caused by improper assembly/ installation, failure to follow instructions and warnings in owner's manual, accident, misuse, abuse, unauthorized modification, or failure to provide reasonable and necessary maintenance (as referenced in the owner's manual.)

5. This Limited Warranty applies only to the cost of repair or replacement of parts and does not include labor (beyond the above warranty period), transportation, service, return and freight charges associated there with expressly specified herein.

6. This Limited Warranty shall not apply to: Service calls to correct installation of the equipment or instruction to owners on how to use the equipment; or any labor costs incurred beyond the applicable labor warranty period.

7. This Limited Warranty is in lieu of all warranties, express or implied, and in lieu of all other obligations or liabilities on the part of TRUE, under no circumstances shall TRUE be liable by virtue of this Limited Warranty or otherwise from damage to any person or property whatsoever for any special, indirect, incidental, secondary or consequential losses, damages or expenses in connection with exercise products.

Any implied warranty is limited in duration to the time period covered by the Limited Warranty. Some states do not allow limitations on how long an implied warranty lasts, or the exclusion may not apply to you. This Limited Warranty grants you specific legal rights and you may also have other rights, which vary from state to state.

NOTE TO AUTHORIZED WARRANTY LABOR PROVIDERS:

Warranty labor reimbursement or warranty parts rights may not be transferred to, reassigned to, a third party without the express written consent of TRUE. Even jobbing out warranty labor requires TRUE's written approval.

ELLIPTICAL SERIAL NUMBERS:

The ES900 ellipticals come with two serial numbers; one on the base and one on the display console (see diagram below). The serial number on the base is located on bottom of the crossbar. The console serial number is located on the bottom right side of each console. Please write down your serial numbers below and keep for your records.

CONSOLE SERIAL NUMBER:

BASE SERIAL NUMBER:



SAMPLE SERIAL NUMBER STICKER:

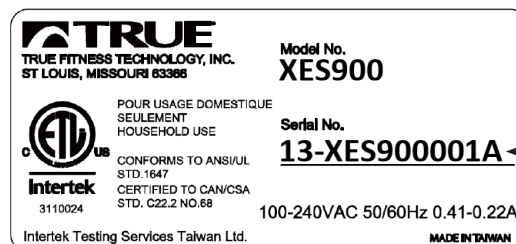

SAMPLE SERIAL NUMBER:

CHAPTER 7: ADDITIONAL INFORMATION



RESIDENTIAL LIMITED WARRANTY ES900 ELLIPTICALS

Thank you for purchasing a TRUE product. To validate the TRUE product warranty the fast and easy way, please go on-line now to truefitness.com/support and register your product. The information you provide will never be distributed to any other individuals or agencies for any purpose. If you prefer to mail your warranty card, have the owner of the product complete the information below and return it to TRUE Fitness within 30 days from the date of equipment installation.

Please Note: Failure to register this product will result in no servicing or authorization of parts to be shipped.

To mail your warranty information, please fill in the information below and mail to: Service Dept., TRUE Fitness, 865 Hoff Road, St. Louis, MO 63366 (or save postage and register online at www.truefitness.com/support)



Residential Warranty Registration

**PLEASE PROVIDE BOTH SERIAL NUMBERS BELOW.
REQUIRED FOR WARRANTY REGISTRATION:**

CONSOLE SERIAL NUMBER:

BASE SERIAL NUMBER:

Model Type: Treadmill Elliptical Bike
 Other

Date of Purchase _____

Purchased From (Dealer Name) _____

First Name _____

Last Name _____

Address _____

City _____ State _____ ZIP _____

Email Address _____

Phone _____

1. Where did you first learn about TRUE?

- a. Dealer b. Website
 c. Advertisement d. Referral
 e. Current Customer f. Other _____

2. The primary user(s) is:

- a. Male b. Female
 c. Both

3. Do you currently belong to a health club?

- a. Yes b. No

4. Your Age Group:

- a. Under 25 b. 25-35
 c. 36-45 d. 46-55
 e. 56-65 f. 65+

5. What was the primary reason you purchased a TRUE product?
(check only one)

- a. Design/Appearance b. Dealer Suggestion
 c. Price/Value d. Ease of Operation
 e. Quality of Construction f. Size
 g. Reputation h. Warranty
 i. Friend/Family Recommendation

6. Do you plan to purchase more fitness equipment in the next 6-12 months?

- a. Yes b. No

7. If you answered "yes" to question 6, what type do you plan to purchase?

- a. Treadmill b. Elliptical
 c. Bike d. Free Weights
 e. Gym f. Other _____

8. What is your annual household income? (optional)

- a. Under \$50,000 b. \$50,000 - \$75,000
 c. \$75,000 - \$100,000 d. \$100,000 - \$150,000
 e. \$15,000+

9. You are a valued TRUE customer and your suggestions allow us to continually improve your experience. Is there anything else you would like us to know? Please explain: