

Club Series Upright Lifecycle[®] Exercise Bike (CSLU)

Operation Manual



CORPORATE HEADQUARTERS

Columbia Centre III, 9525 West Bryn Mawr Avenue, Rosemont, Illinois 60018 • U.S.A.

847.288.3300 • FAX: 847.288.3703

Service phone number: 800.351.3737 (toll-free within U.S.A., Canada)

Global Website: www.lifefitness.com

INTERNATIONAL OFFICES

AMERICAS

North America Life Fitness, Inc.

Columbia Centre III
9525 West Bryn Mawr Avenue
Rosemont, IL 60018 U.S.A
Telephone: (847) 288 3300
Fax: (847) 288 3703
Service Email:
customersupport@lifefitness.com
Service Website: www.lifefitness.com/parts
Sales/Marketing Email:
consumerproducts@lifefitness.com
Operating Hours: 7:00 am-6:00 pm (CST)

Brazil Life Fitness Brasil

Av. Cidade Jardim, 900
Jd. Paulistano
São Paulo, SP 01454-000
BRAZIL
SAC: 0800 773 8282
Telephone: +55 (11) 3095 5200
Fax: +55 (11) 3095 5201
Service Email: suporte@lifefitness.com.br
Sales/Marketing Email:
lifefitness@lifefitness.com.br
Service Operating Hours:
9:00 - 17:00 (BRT) (Monday-Friday)
Store Operating Hours:
9:00 -20:00 (BRT) (Monday-Friday)
10:00 - 16:00 (BRT) (Saturday)

Latin America & Caribbean* Life Fitness Inc.

Columbia Centre III
9525 West Bryn Mawr Avenue
Rosemont, IL 60018 U.S.A
Telephone: (847) 288 3300
Fax: (847) 288 3703
Service Email:
customersupport@lifefitness.com
Sales/Marketing Email:
consumerproducts@lifefitness.com
Operating Hours: 7:00am-6:00pm (CST)

EUROPE, MIDDLE EAST, & AFRICA (EMEA)

Netherlands & Luxemburg Life Fitness Atlantic BV

Bijdorpplein 25-31
2992 LB Barendrecht
THE NETHERLANDS
Telephone: (+31) 180 646 666
Fax: (+31) 180 646 699
Service Email:
service.benelux@lifefitness.com
Sales/Marketing Email:
marketing.benelux@lifefitness.com
Operating Hours: 9.00h-17.00h (CET)

United Kingdom & Ireland Life Fitness UK LTD

Queen Adelaide
Ely, Cambs, CB7 4UB
Telephone: General Office (+44)
1353.666017
Customer Support (+44) 1353.665507
Fax: (+44) 1353.666018
Service Email: uk.support@lifefitness.com
Sales/Marketing Email: life@lifefitness.com
Operating Hours:
General Office: 9.00am - 5.00pm (GMT)
Customer Support: 8.30am - 5.00pm (GMT)

Germany & Switzerland Life Fitness Europe GMBH

Siemensstraße 3
85716 Unterschleißheim
GERMANY
Telephone: (+49) 89.31 77 51.0 (Germany)
(+41) 0848 000 901 (Switzerland)
Fax: (+49) 89.31 77 51.99 (Germany)
(+41) 043 818 07 20 (Switzerland)
Service Email:
kundendienst@lifefitness.com
Sales/Marketing Email:
kundenberatung@lifefitness.com
Operating Hours: 08.30 -16.30h (CET)

Austria Life Fitness Austria

Vertriebs G.m.b.H.
Dücker gasse 7-9/3/36
1220 Vienna
AUSTRIA
Telephone: (+43) 1.61.57.198
Fax: (+43) 1.61.57.198.20
Service Email: kundendienst@lifefitness.com
Marketing/Sales Email:
kundenberatung@lifefitness.com
Operating Hours: 08:30-16.30.h (MEZ)

Spain Life Fitness IBERIA

C/Frederic Mompou 5,1ª^a
08960 Sant Just Desvern Barcelona
SPAIN
Telephone: (+34) 93.672.4660
Fax: (+34) 93.672.4670
Service Email: servicio.tecnico@lifefitness.com
Sales/Marketing Email:
info.iberia@lifefitness.com
Operating Hours:
9.00h-18.00h (Monday-Thursday)
8.30h-15.00h (Friday)

Belgium Life Fitness Benelux NV

Parc Industriel de Petit-Rechain
4800 Verviers
BELGIUM
Telephone: (+32) 87 300 942
Fax: (+32) 87 300 943
Service Email:
service.benelux@lifefitness.com
Sales/Marketing Email:
marketing.benelux@lifefitness.com
Operating Hours: 9.00h -17.00h (CET)

All Other EMEA Countries & Distributor Business C-EMEA*

Bijdorpplein 25-31
2992 LB Barendrecht
THE NETHERLANDS
Telephone: (+31) 180 646 644
Fax: (+31) 180 646 699
Service Email:
service.db.cemea@lifefitness.com
Sales/Marketing Email:
marketing.db.cemea@lifefitness.com
Operating Hours: 9.00h-17.00h (CET)

ASIA PACIFIC (AP)

Japan Life Fitness Japan

Japan Nippon Brunswick Bldg., #8F
5-27-7 Sendagaya
Shibuya-Ku, Tokyo
Japan 151-0051
Telephone: (+81) 3.3359.4309
Fax: (+81) 3.3359.4307
Service Email: service@lifefitnessjapan.com
Sales/Marketing Email:
sales@lifefitnessjapan.com
Operating Hours: 9.00h-17.00h (JAPAN)

Hong Kong Life Fitness Asia Pacific LTD

32/F, Global Trade Square
21 Wong Chuk Hang Road
HONG KONG
Telephone: (+852) 2575.6262
Fax: (+852) 2575.6894
Service Email:
HongKongEnquiry@lifefitness.com
Sales/Marketing Email:
Marketing.HK.Asia@lifefitness.com
Operating Hours: 9.00h-17.00h
Service Operating Hours: 9.00h-18.00h

All Other Asia Pacific countries & distributor business Asia Pacific* Life Fitness Asia Pacific LTD

32/F, Global Trade Square
21 Wong Chuk Hang Road
HONG KONG
Telephone: (+852) 2575.6262
Fax: (+852) 2575.6894
Service Email:
HongKongEnquiry@lifefitness.com
Sales/Marketing Email:
Marketing.HK.Asia@lifefitness.com
Operating Hours: 9.00h-17.00h
Service Operating Hours: 9.00h-18.00h

* Also check www.lifefitness.com for local representation or distributor/dealer

Table of Contents

Important Safety Instructions	5
1 Setup	9
2 Console Overlay	12
2.1 Console Overlay Overview	12
2.2 Console Overlay Descriptions	13
2.3 Reading Rack and Bottle Holder	15
3 Heart Rate Zone Training®	16
3.1 Why Heart Rate Zone Training Exercise?	16
3.2 Heart Rate Monitoring	17
4 Workouts	18
4.1 Workout Overview	18
4.2 Using the Workouts	20
4.3 Workout Descriptions	23
4.4 Using My Workouts Personal Programs	32
5 User Menu (Optional Settings)	33
5.1 Entering and Using the Service Menu	33
5.2 Manager's Configuration (Optional Settings)	34
6 Service and Technical Data	35
6.1 Preventive Maintenance Tips	35
6.2 Preventive Maintenance Schedule	36
6.3 Troubleshooting the Optional Polar® Telemetry Heart Rate Chest Strap	37
6.4 Troubleshooting the Lifepulse™ System Sensors	38
6.5 How to Obtain Product Service / Serial Number Location	38
6.6 Recycling the Battery	38
7 Specifications	39
8 Warranty	40

© 2015 Life Fitness, A division of Brunswick Corporation. All Rights Reserved. Life Fitness is a registered trademark of Brunswick Corporation. Fitlinxx is a trademark of Fitlinxx, Inc. Polar is a registered trademark of Polar Electro, Inc. iPod® and iPhone® are registered trademarks of Apple, Inc. Gym Wipes® is a registered trademark of The 2XL Corporation. PureGreen 24 is a trademark of Pure Green.

Before using this product, it is essential to read this ENTIRE operation manual and ALL installation instructions. It describes equipment setup and instructs members on how to use it correctly and safely.

Avant d'utiliser ce produit, il est indispensable de lire ce manuel d'utilisation dans son INTÉGRALITÉ, ainsi que TOUTES les instructions d'installations.

Ce manuel explique comment installer l'équipement et comment l'utiliser correctement et sans danger.

Class HA (Home): Domestic use.

FCC Warning - Possible Radio / Television Interference

NOTE: This equipment has been tested and found to comply with the limits for a Class B digital device, pursuant to part 15 of the FCC rules. These limits are designed to provide reasonable protection against harmful interference in a residential installation. This equipment generates, uses and can radiate radio frequency energy, and if not installed and used in accordance with the user manual, may cause harmful interference to radio communications. However, there is no guarantee that the interference will not occur in a particular installation. If this equipment does cause harmful interference to radio or television reception, which can be determined by turning the equipment off and on, the user is encouraged to try to correct the interference by one or more of the following measures:

- Re-orient or relocate the receiving antenna.
- Increase the separation between the equipment and the receiver.
- Connect the equipment into an outlet on a circuit different from that to which the receiver is connected.
- Consult the dealer or an experienced radio/TV technician for help.



CAUTION: Any changes or modifications to this equipment could void the product warranty.

Mise en garde : tout changement ou toute modification de ce matériel peut annuler la garantie du produit.

Any service, other than cleaning or user maintenance, must be performed by an authorized service representative.

This Operation Manual describes the functions of the following product:

Club Series Upright Lifecycle® Exercise Bike (CSLR)

See "Specifications" in this manual for product specific features.

Statement of Purpose: The Life Fitness Lifecycle exercise bike is a machine that simulates the movements of riding a bicycle at various speeds and levels of resistance.



CAUTION: Life Fitness STRONGLY recommends seeing a physician for a complete medical exam before undertaking an exercise program, particularly if the user has a family history of high blood pressure or heart disease, is over the age of 45, smokes, has high cholesterol, is obese, or has not exercised regularly in the past year.

If, at any time while exercising, the user experiences faintness, dizziness, pain, or shortness of breath, he or she must stop immediately.



MISE EN GARDE: Life Fitness recommande FORTEMENT de consulter un médecin pour subir un examen médical complet avant de commencer tout programme d'exercice, et tout particulièrement si l'utilisateur a des antécédents familiaux d'hypertension ou de troubles cardiaques, s'il a plus de 45 ans, s'il fume, s'il a du cholestérol, s'il est obèse ou n'a pas fait d'exercice régulièrement depuis un an.

Si, pendant l'utilisation de l'appareil, l'utilisateur ressent un malaise, des vertiges, des douleurs ou des vertiges, des douleurs ou des difficultés à respirer, il doit s'arrêter immédiatement.

IMPORTANT SAFETY INSTRUCTIONS

Read all instructions before using the LIFE FITNESS Lifecycle bike.



WARNING:

Heart rate monitoring systems may be inaccurate. Over exercising may result in serious injury or death. If you feel faint, stop exercising immediately.



WARNING:

Provide at least 3 ft. (0.9 m) between the front or rear of the Life Fitness bike to any other objects and 2 ft. (0.6 m) in the direction the equipment is accessed from.



CAUTION:

Any changes or modifications to this product could void the product warranty.

- Always follow the console instructions for proper operation.
- This appliance is not intended for use by persons (including children) with reduced physical, sensory, or mental capabilities, or lack of experience or knowledge unless they have supervision or been given instruction concerning the use of the appliance by a person responsible for their safety.
- Do not use this product outdoors, near swimming pools or in areas of high humidity.
- Never operate a Life Fitness product with the air openings blocked. Keep air openings free of lint, hair, or any other obstructing material.
- Never insert objects into any opening in this product. If an object should drop inside, carefully retrieve it. If the item cannot be reached, contact Life Fitness Customer Support Services.
- Never place liquids of any type directly on the unit, except in an accessory tray or holder. Containers with lids are recommended.
- Do not use these products in bare feet. Always wear shoes. Wear shoes with rubber or high-traction soles. Do not use shoes with heels, leather soles, cleats or spikes. Make sure no stones are embedded in the soles.
- Keep all loose clothing, shoelaces, and towels away from moving parts.
- Do not reach into, or underneath, the unit or tip it on its side during operation.
- Do not allow other people to interfere in any way with the user or equipment during a workout.
- Use these products for their intended use as described in this manual. Do not use attachments that have not been recommended by the manufacturer.
- Use caution when mounting or dismounting the Lifecycle bike.
- Never face backward while using the Lifecycle bike.
- Never operate a Life Fitness product if it has been dropped, damaged, or even partially immersed in water. Contact Life Fitness Customer Support Services.

- Children should be supervised to ensure they do not play with the product.
- Read all warnings on each product prior to starting a workout.
- Health and Environmental Regulations Warning - This product may contain chemicals known to the State of California to cause cancer, birth defects, or other reproductive harm. For more information related to the European Commission Regulation (EC) No. 1907/2006 (REACH) and the California Safe Drinking Water and Toxic Enforcement Act of 1986 (Proposition 65), please visit <https://www.lftechsupport.com/web/guest/environmental-regulations-information>.

**SAVE THESE INSTRUCTIONS FOR
FUTURE REFERENCE.**

CONSIGNES DE SÉCURITÉ IMPORTANTES

Lire toutes les instructions avant d'utiliser les appareils Life Fitness.

 **AVERTISSEMENT :** Des systèmes de surveillance de fréquence cardiaque peuvent être inexacts. Trop d'exercices peuvent entraîner des blessures sérieuses, voire mortelles. En cas de sensation d'évanouissement, arrêter immédiatement l'entraînement.

 **WARNING:** Établir une distance d'au moins 0,9 m (3 ft.) entre l'avant ou l'arrière du vélo de LIFE FITNESS et d'autres objets.

 **ATTENTION :** Toute modification apportée à cet appareil peut en annuler la garantie.

- Pour un fonctionnement correct, suivez toujours les instructions de la console.
- Cet appareil n'est pas prévu pour être utilisé par des personnes (y compris les enfants) dont les capacités physiques, sensorielles ou mentales sont réduites, ou des personnes dénuées d'expérience ou de connaissance, sauf si elles ont pu bénéficier, par l'intermédiaire d'une personne responsable de leur sécurité, d'une surveillance ou d'instructions préalables concernant l'utilisation de l'appareil.
- N'utilisez pas ce produit à l'extérieur, près d'une piscine ou dans endroits très humides.
- Ne faites jamais fonctionner de produit Life Fitness dont les bouches d'aération seraient bloquées. Maintenez-les exemptes de peluches, de cheveux ou de toute obstruction.
- N'insérez jamais d'objet dans les ouvertures de cet appareil. Si un objet tombe dedans, coupez l'alimentation électrique, débranchez le cordon de la prise et récupérez-le avec précaution. Si vous ne pouvez pas l'atteindre, consultez le service après-vente de Life Fitness.
- Ne placez jamais de liquides d'aucune sorte directement sur l'appareil, sauf si vous disposez d'un support ou d'un plateau pour accessoires. Il est recommandé d'utiliser des conteneurs munis d'un couvercle.
- N'utilisez pas l'appareil pieds nus. Portez toujours des chaussures. Portez toujours des chaussures de sport à semelles en caoutchouc ou à haute traction. N'utilisez pas de chaussures à talon, à semelle en cuir, à crampons ou à pointes. Vérifiez qu'aucun gravier n'est coincé dans vos semelles.
- Éloigner les vêtements lâches, les lacets et les serviettes des pièces en mouvement.
- Ne placez pas les mains sous ou dans l'appareil, et ne le renversez pas sur le côté pendant le fonctionnement.
- Ne laissez aucune personne gêner l'utilisateur ou le fonctionnement de l'appareil pendant un exercice.
- Cet appareil ne doit être employé que pour l'usage auquel il est destiné, conformément aux directives de ce manuel. N'utilisez pas d'accessoires qui ne seraient pas recommandés par le fabricant.
- Procédez avec précaution lors du montage ou du démontage du produit.
- N'utilisez jamais cet appareil en vous tournant vers l'arrière.
- N'utilisez jamais un produit Life Fitness qui serait tombé, qui aurait été endommagé ou partiellement immergé. Contactez le Service clientèle Life Fitness.

- Les enfants doivent faire l'objet d'une surveillance afin de veiller à ce qu'ils ne jouent pas avec l'appareil.
- Lisez tous les avertissements sur chaque produit avant de démarrer un exercice.
- Règlementation en matière de santé et d'environnement : avertissement - Ce produit peut contenir des substances chimiques considérées par l'État de Californie comme cancérigènes et causant des malformations congénitales ou d'autres troubles de l'appareil reproducteur. Pour plus d'informations sur la réglementation européenne n° 1907/2006 (REACH) et le California Safe Drinking Water and Toxic Enforcement Act de 1986 (Proposition 65), connectez-vous à l'adresse suivante : <https://www.lftechsupport.com/web/guest/environmental-regulations-information>.

**CONSERVER CES INSTRUCTIONS
POUR TOUT USAGE ULTÉRIEUR.**

1 SETUP

Read the entire Operation Manual before setting up the Lifecycle exercise bike.

Where to Place the Lifecycle Exercise Bike

Follow all IMPORTANT SAFETY INSTRUCTIONS and move the bike to the location in which it will be used. See Section 7, *Specifications*, for the dimensions of the footprint. Provide at least 3 ft. (0.9 m) between the front or rear of the Life Fitness bike to any other objects and 2 ft. (0.6 m) in the direction the equipment is accessed from.

How to Stabilize the Lifecycle Exercise Bike

After placing the bike in position, check the unit's stability by attempting to rock it from side to side. Any slight rocking indicates that the unit must be leveled. Determine which foot is not resting completely on the floor. Loosen the jam nut (A) with an open-end 9/16-inch wrench, and rotate the stabilizing foot (B) to lower it. Verify that the bike is stable, and repeat the adjustment as necessary until the unit no longer rocks. Lock the adjustment by tightening the jam nut against the stabilizer bar.

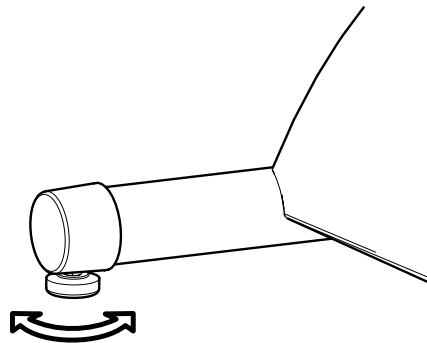

How to Adjust the Seat

It is important to adjust the seat to an optimal height for pedaling on the Lifecycle Exercise Bike. Pedaling with the seat too low can place excessive strain on the knees and quadriceps muscles. Pedaling with the seat too high can irritate the feet, ankles, hips, and knees. To determine whether or not the seat requires adjustment, sit on it and place the balls of the feet on the pedals. The knee should bend slightly when the pedal is at the lowest point of its rotation. It should be possible to pedal without locking the knees or shifting in the seat.

The bike features a vertical ratchet seat adjustment system, which makes it easy and safe to change the height of the seat quickly. To raise the seat, either lift the body so that there is no weight on the seat, or get off the bike. Then, simply pull the seat upward to the desired height, and let it lock into place. Test and readjust the seat height as necessary.

To lower the seat, first get off the bike. Holding the seat, pull up the adjustment lever in front of the seat post to unlock the post, let the seat slide down to the desired height, and release the lever to lock the post in to place. Test and readjust the seat height as necessary.

CAUTION: When using the height adjustment mechanism to change the height of a partially raised seat, hold the seat to prevent it from falling on the hand.

MISE EN GARDE Lorsque vous utilisez le mécanisme dérèglage de la hauteur pour monter une selle déjà partiellement surélevée, maintenez cette dernière afin qu'elle ne vous tombe pas sur la main.

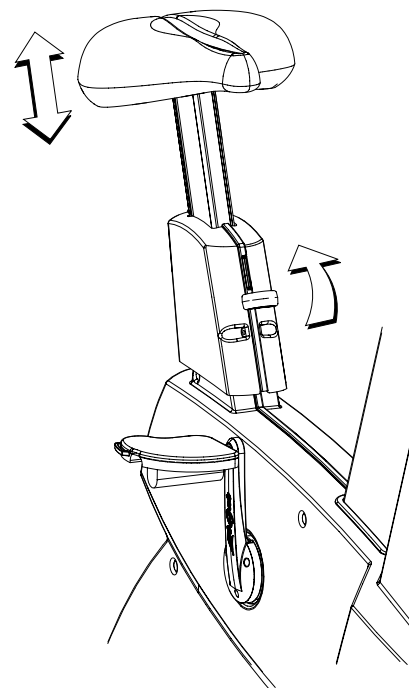

How to Adjust the Pedal Straps

The bike pedal straps keep the user's shoes on the pedals during a workout. The straps should fit comfortably, but they also should be tight enough to prevent shoes from slipping at any point in the pedaling rotation. Before working out, a user should test and adjust the tightness of the straps.

The safety straps on the foot pedals can be adjusted to fit a variety of shoe sizes. The straps are held in place by two knobs that extend from either side of each pedal. The "inner" knob extends sideways, that is, toward the bike. The "outer" knob extends downward. The ends of each strap are perforated with slots that fit tightly over the knobs. The "inner" end of each strap is perforated with two slots, and the "outer" segment of the strap is perforated with a row of slots.

To tighten or loosen a strap, grasp the outer end, and pull it back, away from the knob, until the strap slides off. Pull the strap out through the outer loop on the pedal. Rest the foot on the pedal, and wrap the strap over the foot to determine the desired length. Thread the strap through the outer loop on the pedal, tuck it under the pedal, select the appropriate slot, and pull that slot down over the knob, until the top of the knob pops through the slot. A click indicates that the strap is locked into place.

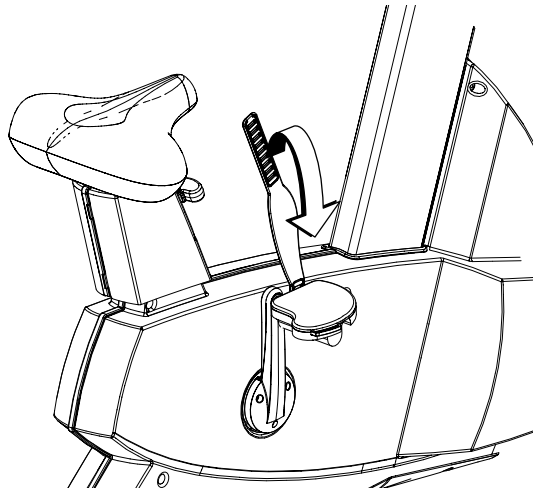

Starting Up the Bike Console

When a user begins pedaling on the Lifecycle exercise bike, the unit's Auto-Start feature powers up the console, causing the console display to light up and the MESSAGE CENTER to flash a prompt: "SELECT WORKOUT USING ARROW KEYS OR PRESS QUICK START". If the user does not make a selection in 20 seconds, the console automatically starts a MANUAL workout. For information on setting up a workout, see Section 4.2, *Using the Workouts*. If the user stops pedaling for more than 15 seconds, the console shuts down. Alternately, the user may press the START key to power up the console.

Service Access Port

The two interchangeable type RJ45 networking ports (A) are located on the back of the display console and are enclosed by a removable cover. Any use of the ports other than their intended purpose could void the product warranty.



Location of Service Ports

2 Console Overlay

2.1 Console Overlay Overview

The computerized display console allows the user to tailor a workout to personal fitness abilities and goals and to monitor progress. With this easy-to-use console, the user can track fitness improvement from one workout to the next.

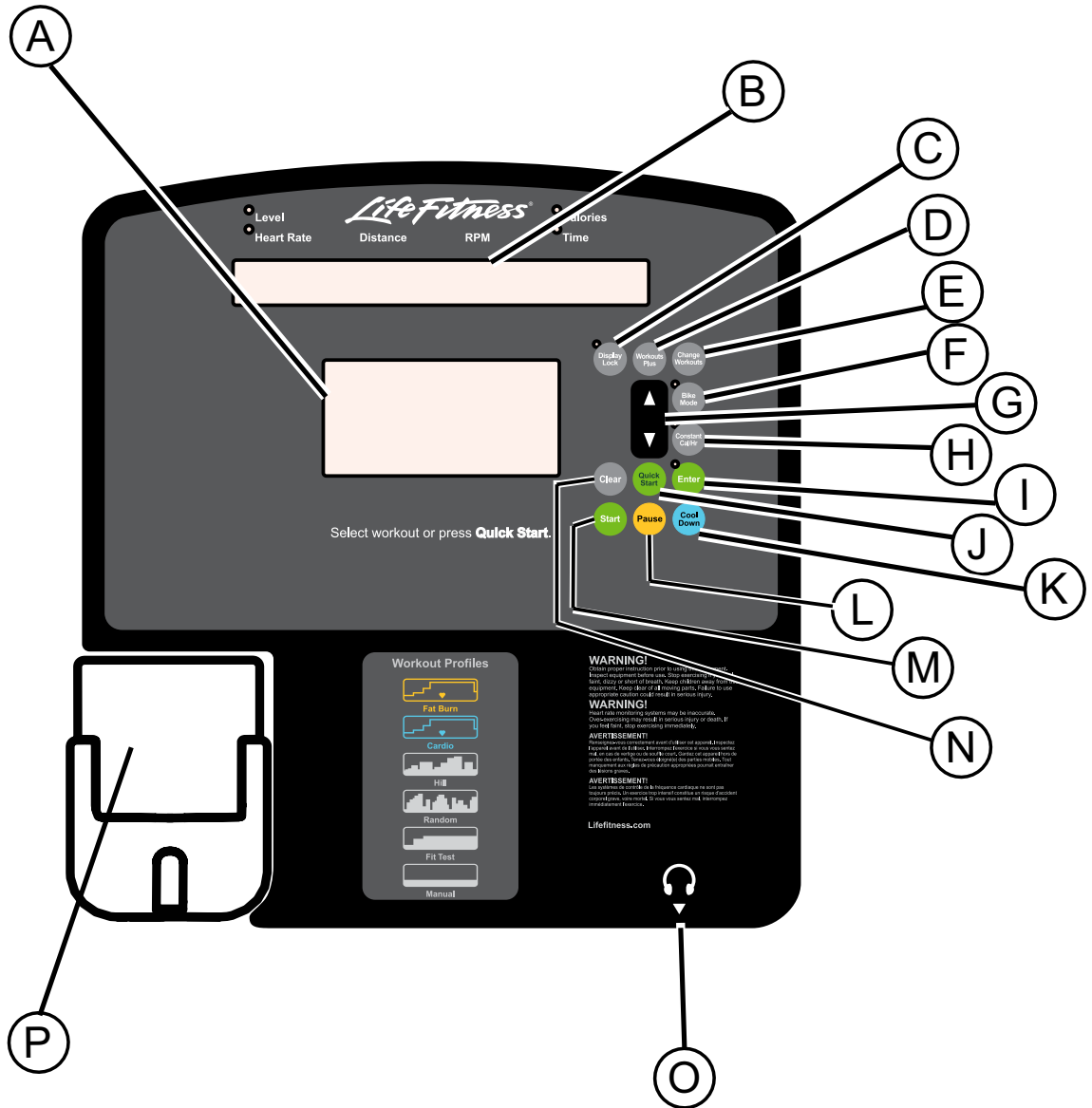

2.2 Console Overlay Descriptions

- A. **WORKOUT PROFILE WINDOW:** This window displays shapes, made of columns of lights, that represent the levels of intensity in a workout-in-progress. The height of the first column on the left side of the window is proportional to the current level of intensity.

During a FAT BURN, CARDIO, HEART RATE HILL, HEART RATE INTERVAL, or EXTREME HEART RATE workout, which requires the use of a Polar® telemetry heart rate chest strap or the Lifepulse™ system sensors, the Workout Profile window displays a flashing heart shape to request the user's heart rate signal. If the console does not detect a signal, the MESSAGE CENTER displays the prompt "NEED HEART RATE - PLACE HANDS ON SENSORS OR USE TELEMETRY STRAP". If the console does not receive the signal within three minutes, the workout automatically is converted to a MANUAL program.

- B. **MESSAGE CENTER:** This window displays step-by-step instructions for setting up a workout. During a workout, it displays statistics about the progress of the workout:

- **Level:** the programmed intensity level. It is displayed continuously unless the heart rate is being measured, in which case, HEART RATE is displayed.
- **Heart Rate:** the detected heart rate if the user is wearing the chest strap or grasping the Lifepulse system sensors. If the heart rate is not being measured during a workout, then LEVEL is displayed instead.
- **Distance:** the total distance traveled in miles (or kilometers if enabled).
- **RPM (Revolutions per Minute):** the pedaling speed or rate.
- **Calories:** the number of calories burned since beginning the workout, alternates with TIME.
- **Time:** time elapsed since the start of the workout; alternates with CALORIES.

If configured to do so, the MESSAGE CENTER displays other values each time the intensity level changes during the workout:

- **Calories per Hour:** the rate of calories burned per hour.
- OR**
- **Watts:** effort level in Watts. The Watt is a unit of power output or the expression of the mechanical rate of work.
 - **METs:** effort level in METs. The MET is an expression of the rate of work for the human body at rest, or a metabolic equivalent; one MET is approximately equal to the metabolism of a person at rest.

- C. **DISPLAY LOCK:** During a workout, the MESSAGE CENTER alternately displays the number of CALORIES BURNED and the amount of TIME ELAPSED. Pressing the DISPLAY LOCK key when the MESSAGE CENTER displays either statistic, forces the MESSAGE CENTER to display that statistic continuously throughout the workout. Pressing DISPLAY LOCK again allows the MESSAGE CENTER to resume toggling between both statistics.
- D. **WORKOUTS PLUS:** When prompted by the MESSAGE CENTER to select a workout, press this key to select WATTS (when enabled), METs (when enabled), LIFE FITNESS FIT TEST, MILITARY FIT TEST (when enabled), AEROBICS TRAINER, INTERVAL, AROUND THE WORLD, CASCADES, FOOTHILLS, SPEED TRAINING, or KILIMANJARO programs.
- E. **CHANGE WORKOUTS:** Press this key to change workout programs during a workout (on the fly).
- F. **BIKE MODE:** Press this key to activate the Bike workout mode in which the rate of calories burned and total distance traveled increase automatically as the user increases the pedaling speed.
- G. **ARROW keys:** When prompted by the MESSAGE CENTER to select a workout, use these keys to scroll through displayed choices. When setting up a workout, use these keys to change workout parameters displayed on the console, such as length of workout, weight, age, target heart rate, and intensity level. During a workout, pressing the ARROW keys changes intensity levels or target heart rate.
- H. **CONSTANT CAL./HOUR:** Press this key to activate this alternate workout mode, which enables a user to maintain a consistent rate of calories burned per hour.
- I. **ENTER key:** Press this key to confirm entries of workout setup values, as displayed in the MESSAGE CENTER.

- J. **QUICK START key:** Press this key to begin a manual workout immediately, without having to select a workout program. Once the workout is in progress, use the ARROW keys to change the intensity level or workout duration as desired.
- K. **COOL DOWN key:** Workout programs end automatically in a Cool Down mode, which lowers the intensity level. Press the COOL DOWN key at any desired point during a workout to go immediately into Cool Down mode. In this phase of a workout the body begins to remove lactic acid and other accumulated by-products of exercise, which build up in muscles during a workout and contribute to muscle soreness. The console automatically adjusts each workout's Cool Down level according to the individual user's performance.
- L. **PAUSE:** Press this key to pause the current workout. Continue the workout by pressing the PAUSE key again, or by pressing ENTER.
- M. **START:** Press this key, while pedaling, to activate the console for programming a new workout. The activated console lights up and displays SELECT WORKOUT USING ARROW KEYS OR PRESS QUICK START.
- N. **CLEAR KEY:** Press this key, when programming a workout, to clear incorrect data, such as weight or age, before pressing the ENTER key. Pressing CLEAR during a workout stops it immediately, at which point, the MESSAGE CENTER displays a summary of the workout, including total time elapsed, total distance traveled, and total calories burned. Pressing CLEAR a second time causes the MESSAGE CENTER to prompt the user for a new workout setup.
- O. **HEADPHONE JACK:** Headphones must be plugged into the Bike to access the sound for the iPod. The jack is not a user-replaceable feature. Contact Life Fitness Customer Support Services for more information.
- P. **MOBILE DEVICE HOLDER:** Use the holder for storing mobile devices. Users may charge their devices via the universal USB port.

2.3 Reading Rack and Bottle Holders

Two water bottle holders (A) are available to hold water bottles and/or personal objects. Additionally, an integrated reading rack (B) for supporting a book or magazine is located at the base of the upper panel of the console.

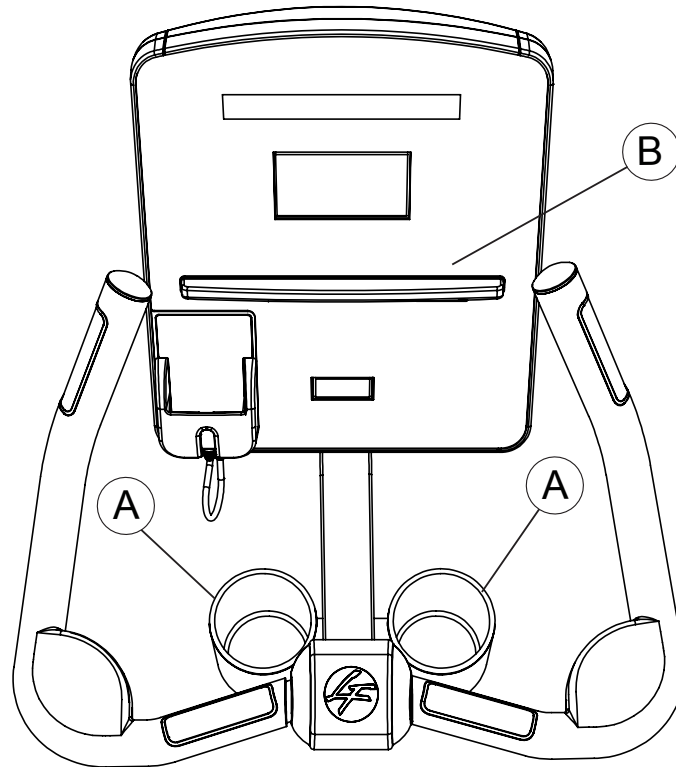

3 Heart Rate Zone Training®

3.1 Why Heart Rate Zone Training Exercise?

Research shows that maintaining a specific heart rate while exercising is the optimal way to monitor the intensity of a workout and to achieve maximum results. That is the idea behind the Life Fitness Heart Rate Zone Training® approach to exercise.

Zone Training identifies an exerciser’s ideal heart rate range, or zone, for burning fat or increasing cardiovascular fitness. The zone is a percentage of the theoretical maximum (HRmax), and its value depends on the workout. The maximal Heart Rate formula is defined by the American College of Sports Medicine’s “Guidelines for Exercise Testing and Prescription”, 8th Edition, 2010. HRmax equals to 206.9 minus the total of 0.67 multiplied by a person’s age.

$$\text{HR Max} = 206.9 - (0.67 * \text{age})$$

The Life Fitness Lifecycle exercise bike features five exclusive workouts designed to take full advantage of the benefits of Heart Rate Zone Training+ exercise:

- FAT BURN
- HEART RATE HILL™
- EXTREME HEART RATE™
- CARDIO
- HEART RATE INTERVAL™

Each workout offers different benefits, as discussed in Section 4, *The Workouts*.

NOTE: Consulting a fitness trainer is recommended for defining specific fitness goals and designing a workout program.

To change the target heart rate during a workout, use the ARROW keys. To switch between programs during a workout, use the CHANGE WORKOUTS KEY.

The Heart Rate Zone Training® workout programs measure heart rate. Wear the optional Polar® telemetry heart rate chest strap, or grip the Lifepulse™ sensors, to enable the bike’s on-board computer to monitor the heart rate during a workout. The computer automatically adjusts the resistance level to maintain the target heart rate based on the actual heart rate.

Age	Theoretical Maximum Heart Rate	65% (Fat Burn)	80% (Cardio)
10	200	130	160
20	194	126	155
30	187	121	149
40	180	117	144
50	173	113	139
60	167	108	133
70	160	104	128
80	153	100	123
90	147	95	117
99	141	91	112

NOTE: Reference the above chart for Theoretical Maximum Heart Rates and Target Heart Rates.

3.2 Heart Rate Monitoring

The Lifepulse™ Digital Heart Rate Monitoring System

The patented Lifepulse system sensors are the built-in heart rate monitoring system on the Life Fitness Lifecycle bike. For the most accurate reading possible, during a workout:

- Grasp two of the four sensors (A) firmly.
- Hold each sensor at the vertical midpoint.
- Keep hands steady and in place.

The console displays the heart rate within 10 to 40 seconds after the user grasps the sensors. The following factors may affect a Lifepulse reading: incorrect hand placement on the sensors, upper body activity, lotion or dirt on hands, and excessive or insufficient pressure used when gripping the sensors.

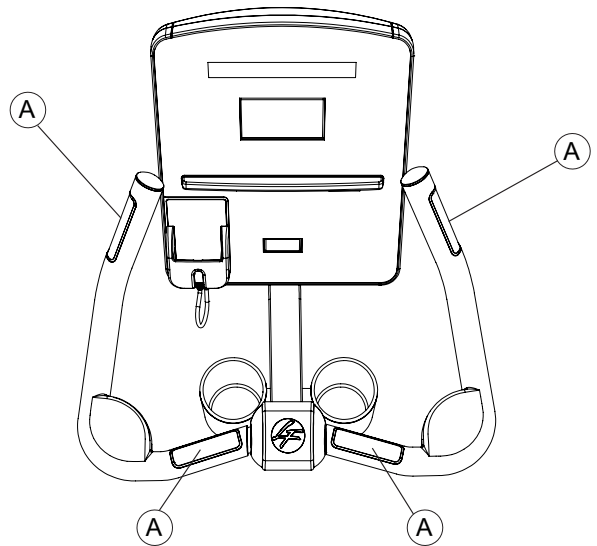

The Optional Polar® Telemetry Heart Rate Chest Strap

The Life Fitness Lifecycle Bike is equipped with Polar® telemetry, a heart rate monitoring system in which electrodes, pressed against the skin, transfer heart rate signals to the console. These electrodes are attached to a Polar telemetry heart rate chest strap that the user wears during the workout. The Polar telemetry heart rate chest strap is optional. Contact Life Fitness Customer Support Services to order.

See the diagram below for correct positioning of the Polar telemetry heart rate chest strap. The electrodes (A), which are the two grooved surfaces on the underside of the strap, must remain wet to transmit accurately the electrical impulses of the heart back to the receiver. Moisten the electrodes. Then, secure the Polar telemetry heart rate chest strap as high under the chest muscles as possible. The strap should be snug, but comfortable enough to allow for normal breathing.

The transmitter strap delivers an optimal heart rate reading when the electrodes are in direct contact with bare skin. However, it functions properly through a thin layer of wet clothing.

If it becomes necessary to re-moisten the Polar telemetry heart rate chest strap electrodes, grasp the center of the strap, pull it away from the chest to expose the two electrodes, and re-moisten them.

NOTE: If the Lifepulse system sensors are grasped while the chest strap is worn, and if the signals from the sensors are valid, the on-board computer uses the sensor signals for calculating the heart rate instead of those transmitted with the Polar telemetry heart rate chest strap.

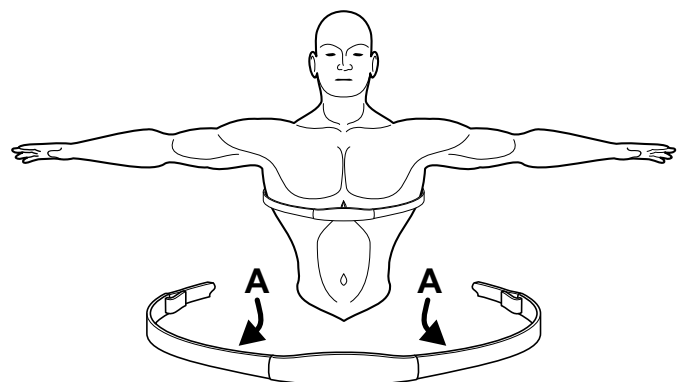

4 Workouts

4.1 Workout Overview

This section lists the Life Fitness Lifecycle exercise Bike pre-programmed workouts. For more detailed information, see Section 4.2, *Using the Workouts*.

QUICK START is the fastest way to begin exercising. After the QUICK START key is pressed, a constant-level workout begins. The intensity level does not change automatically.

MANUAL is a constant effort workout in which the user can change the intensity level at any time.

RANDOM is an interval training workout of constantly changing intensity levels that occur in no regular pattern or progression.

FAT BURN is a low-intensity workout for burning a higher percentage of calories from fat. The user wears a Polar telemetry heart rate chest strap, or grasps the Lifepulse sensors continuously. The program adjusts the intensity level through changing the incline (elevation), based on the actual heart rate, to maintain the rate at 65 percent of the theoretical maximum.

CARDIO is a higher intensity workout for more fit users, maximizing cardiovascular benefits and total calories burned. The user wears a Polar telemetry heart rate chest strap, or grasps the Lifepulse sensors continuously. The program adjusts the intensity level, based on the actual heart rate, to maintain the rate at 80 percent of the theoretical maximum.

HILL is an interval training workout. Intervals are periods of intense aerobic exercise separated by regular periods of lower-intensity exercise.

HEART RATE HILL™ takes the user through three different hills based on the target heart rate. The user wears a Polar telemetry heart rate chest strap or grasps the Lifepulse sensors continuously.

HEART RATE INTERVAL™ alternates between a hill and a valley based on the target heart rate. The user wears a Polar telemetry heart rate chest strap or grasps the Lifepulse sensors continuously.

EXTREME HEART RATE™ is an intense workout for more experienced users. It is designed to get the heart rate up and down as quickly as possible. The user wears a Polar telemetry heart rate chest strap or grasps the Lifepulse sensors continuously.

SPORT TRAINING simulates an outdoor terrain by setting various resistance levels.

EZ RESISTANCE features a gradual, subtle increase in resistance, independent of the user's pedaling speed. A peak in resistance is followed by an equally subtle decrease in resistance.

The following workouts are accessed by pressing the **WORKOUTS PLUS** key.

AROUND THE WORLD is an interval-training workout in which the hills resemble scenes of various geographical areas.

CASCADES is a two-peak workout in which intensity levels gradually increase and decrease.

FOOTHILLS is a rolling hill workout with low intensity levels.

INTERVAL is a HILL workout in which intensity levels rise and fall. The higher levels gradually incline toward a peak and then gradually decline.

KILIMANJARO is a HILL workout in which the intensity levels gradually incline toward one ultimate peak and then gradually decline.

SPEED TRAINING is a HILL workout in which the intensity level alternates between high and low levels very quickly to simulate a typical speed training workout.

LIFE FITNESS FIT TEST estimates cardiovascular fitness and can be used to monitor improvements in endurance every 4-6 weeks.

MILITARY FITNESS TEST is similar to the FIT TEST workout, except that this program is based upon a specific predefined protocol. The available test is:

- **AIR FORCE PHYSICAL READINESS TEST (PRT)** - *(U.S. MILITARY)*

WATTS targets a rate of effort equal to a certain number of Watts. By default, this workout is turned off. For information on making it available, see Section 5, *System Menu*.

METs targets a rate of effort equal to a certain number of METs. By default, this workout is turned off. For information on making it available, see Section 5, *System Menu*.

AEROBICS TRAINER is a workout in which the MESSAGE CENTER prompts the user to switch continuously between a high and low pedaling speed. The speed intervals alternate in a pattern that promotes a build-up in the intensity of the workout, followed by a build-down in intensity.

4.2 Using the Workouts

Different Bike workouts require different setup steps. See the chart at the end of this section for a quick glance at the steps for setting up any workout program. This section provides details on the steps themselves.

To Begin a Workout

Start pedaling and press START, or simply start pedaling to activate the console. The MESSAGE CENTER displays the prompt: "SELECT WORKOUT USING ARROW KEYS OR PRESS QUICK START". If it displays a different message, press the CLEAR key twice rapidly.

Selecting and Using Quick Start

QUICK START is the fastest way to begin exercising and bypasses the steps of selecting a specific workout program. At the MESSAGE CENTER prompt to select a workout, press the QUICK START key. The workout begins at an intensity level that remains the same unless manually changed.

Selecting a Workout

For all workouts: When prompted to select a workout, use the ARROW KEYS or WORKOUT PLUS key to scroll through the workout names as they appear in the MESSAGE CENTER. When the desired workout appears, press ENTER.

For MY WORKOUTS, once a workout is configured and saved, no further setup steps are necessary. For more information, see Section 4.4, *Using My Workouts Personal Programs*.

Entering Weight

When prompted by the MESSAGE CENTER to enter weight, use the ARROW KEYS to increase or decrease the displayed weight to the correct value and press ENTER. The default weight is 150 pounds or 68 kilograms.

Entering Age

When prompted by the MESSAGE CENTER to enter age, use the ARROW KEYS to increase or decrease the displayed age to the correct value and press ENTER. Life Fitness bike workout programs that set a target heart rate zone first calculate the user's theoretical maximum heart rate. The HRmax equals 206.9 minus the total of 0.67 multiplied by a person's age. The programs then calculate the target zone as a percentage of the theoretical maximum.

Entering Time

When prompted by the MESSAGE CENTER to enter a time, use the ARROW keys to increase or decrease the displayed time to the desired value and press ENTER.

Selecting and Adjusting the Intensity Level

When prompted by the MESSAGE CENTER, use the ARROW KEYS to increase or decrease the displayed intensity level or target heart rate to the desired value, and press ENTER. Adjust the level as needed or desired during the workout.

- **Intensity Level:** The Bike provides a selection of 20 intensity levels. The intensity level appears in the WORKOUT PROFILE window as rows of lights arranged in columns. Selecting a low intensity level at first is recommended. As physical conditioning improves, the levels can be increased.
- **Target Heart Rate:** Programs that calculate a target heart rate base this number on the age of the user and the type of workout. The user accepts or adjusts the rate when setting up the workout. During the workout itself, the program reads the heart rate, which is transmitted via the heart rate chest strap or the Lifepulse system sensors; it uses this data to adjust the resistance. Manually raising the rate increases the intensity of the cardiovascular exercise.

Selecting a Workout Mode

Two workout mode options on the Life Fitness Lifecycle exercise bike feature alternate ways to vary workouts.

- **Bike Mode:** This workout mode simulates the experience of riding a real bicycle. The rate of calories burned and total distance travelled increase automatically as the user increases the pedaling speed. This mode can be used with all workouts, except for FAT BURN, CARDIO, HEART RATE HILL, HEART RATE INTERVAL, EXTREME HEART RATE, WATTS, METS, FIT TEST, and AIR FORCE PRT. To select Bike mode, press the BIKE MODE key.
- **Constant-Calories-Per-Hour Mode:** This workout mode enables a user to maintain a consistent rate of calories burned per hour. As the pedaling speed increases, the resistance level automatically decreases. As the pedaling speed decreases, the resistance level automatically increases. This mode can be used with all workouts. To select it, press the CONSTANT CAL./HR. key.

If the user selects a FAT BURN, CARDIO, HEART RATE HILL, HEART RATE INTERVAL, EXTREME HEART RATE, WATTS, METS, FIT TEST, or AIR FORCE PRT workout during the setup, Constant-Calories-Per-Hour is the default mode. For all other workouts, Bike mode is the default. The user may select or change a mode during a workout setup ordering a workout.

Switching Workouts "On-the-Fly"

It is possible, during a workout, to switch to another workout program. After a switch, the console retains all the progress information about the workout since its beginning. To change workouts "on the fly," simply press the CHANGE WORKOUT key for the desired new workout. This feature is available for all workouts except for AROUND THE WORLD, KILIMANJARO, INTERVAL, CASCADES, SPEED TRAINING, FOOTHILLS, FIT TEST and AIR FORCE PRT workouts.

Pausing Workouts

To pause a workout, simply stop pedaling. To resume, start pedaling and press the ENTER key when prompted TO CONTINUE WORKOUT.

Ending Workouts Early

To end a workout before the pre-set duration expires, press CLEAR once. The MESSAGE CENTER then displays a workout summary, which includes the distance travelled, the total calories burned, and other statistics. Press CLEAR a second time and the MESSAGE CENTER displays "SELECT WORKOUT USING ARROW KEYS OR PRESS QUICK START" for a new workout.

STEPS TO SETUP EACH WORKOUT

<p>QUICK START Press QUICK START Begin workout</p>	<p>INTERVAL Press WORKOUTS PLUS repeatedly until INTERVAL appears; Press ENTER Enter time Select level Begin workout</p>	<p>EXTREME HEART RATE™ Press ARROW keys repeatedly until EXTREME HEART RATE appears; press ENTER Enter Time Enter age Accept/Enter target heart rate Begin workout</p>
<p>MANUAL Select MANUAL Enter time Select level Begin workout</p>	<p>FOOTHILLS Press WORKOUTS PLUS repeatedly until FOOTHILLS appears; press ENTER Enter time Select level Begin workout</p>	<p>SPORT TRAINING Press ARROW keys repeatedly until SPORT TRAINING appears; press ENTER Enter time Select level Begin workout</p>
		<p>EZ RESISTANCE Press ARROW keys repeatedly until EZ RESISTANCE appears; press ENTER Enter time Select level Begin workout</p>
<p>RANDOM Select RANDOM Enter time Select Level Begin workout</p>	<p>KILIMANJARO Press WORKOUTS PLUS repeatedly until KILIMANJARO appears; press ENTER Enter time Select level Begin workouts</p>	<p>LIFE FITNESS FIT TEST Press WORKOUTS PLUS repeatedly until FIT TEST appears; press ENTER Enter weight Enter age Enter gender Select level Begin workout</p>
<p>FAT BURN Select FAT BURN Enter time Enter age Accept / change target heart rate Begin workout</p>	<p>CASCADES Press WORKOUTS PLUS repeatedly until CASCADES appears; press ENTER Enter time Select level Begin workout</p>	<p>AEROBICS TRAINER Press WORKOUTS PLUS repeatedly until AEROBICS TRAINER appears; press ENTER Enter time Select level Begin workout</p>
<p>CARDIO Select CARDIO Enter time Enter age Accept / change target heart rate Begin workout</p>	<p>SPEED TRAINING Press WORKOUTS PLUS repeatedly until SPEED TRAINING appears; press ENTER Enter time Select level Begin workout</p>	<p>METS Press WORKOUTS PLUS repeatedly until METS appears; press ENTER Enter weight Enter time Enter METs goal value Begin workout</p>
<p>HILL Press ARROW keys repeatedly until HILL appears; press ENTER Enter time Select level Begin workout</p>	<p>HEART RATE HILL™ Press ARROW keys repeatedly until HEART RATE HILL appears; press ENTER Enter time Enter age Accept / Enter target heart rate Begin workout</p>	<p>WATTS Press WORKOUTS PLUS repeatedly until WATTS appears; press ENTER Enter time Enter Watts goal value Begin workout</p>
<p>AROUND THE WORLD Press WORKOUTS PLUS repeatedly until AROUND THE WORLD appears; press ENTER Enter time Select level Begin workout</p>	<p>HEART RATE INTERVAL™ Press ARROW keys repeatedly until HEART RATE INTERVAL appears; press ENTER Enter time Enter age Accept / Enter target heart rate Begin workout</p>	<p>AIR FORCE PRT Press WORKOUTS PLUS repeatedly until AIR FORCE PRT appears; press ENTER Enter weight Enter height Enter age Enter gender Answer prompt Begin workout</p>

4.3 Workout Descriptions

QUICK START is the fastest way to begin exercising and bypasses the steps of selecting a specific workout program. The intensity level for the workout is set automatically and remains the same unless manually changed. To change the level, use the ARROW keys to enter a higher or lower level number.

MANUAL

The MANUAL program sets an intensity level that does not change automatically. While the workout is in progress, raise or lower the intensity level as desired using the ARROW keys.

RANDOM

The RANDOM program creates a terrain of hills and valleys that varies with each workout. More than one million different patterns are possible.

FAT BURN

The FAT BURN workout is designed to maintain a user's heart rate at 65% of the theoretical maximum (HRmax) for optimal results. Throughout the workout, the user wears a Polar telemetry heart rate chest strap or grasps the Lifepulse sensors. If the user is not wearing a Polar telemetry heart rate chest strap, the WORKOUT PROFILE WINDOW displays a heart shape, and the MESSAGE CENTER displays a prompt to grasp the sensors. The console continuously monitors and displays the heart rate, adjusting the intensity level of the Bike to reach and maintain the target. This system eliminates over-training and under-training, and it maximizes the aerobic benefits of exercise by using the body's fat stores for fuel.

CARDIO

The CARDIO workout is virtually identical to Fat Burn, however the target heart rate is calculated at 80% of the theoretical maximum (HRmax). The higher target promotes cardiovascular improvement by placing a heavier workload on the heart muscle.

SPORT TRAINING™ WORKOUT

This workout sets different hills, or resistance levels, throughout the course. Each hill matches a progressive degree of difficulty. Hills last between 30 and 60 seconds, depending on the workout duration.

EZ RESISTANCE

In this workout, the gradual changes in resistance are extremely subtle, lowering perceived exertion. The changes in resistance also are independent of a user's pedaling speed. The cardiovascular workout is effective, efficient, and enjoyable at the same time.

The workout consists of one hill. The user determines the height of the peak of this hill by selecting an intensity level during the setup. The higher the level selected, the higher the intensity at the entry point, which is the beginning of the workout, and the higher the intensity at the peak, which occurs after 75% of the workout is completed. After the peak is reached, the resistance gradually returns to the same intensity level as that of the entry point. See the chart below.



EZ Resistance Workout Profile

HILL

The Life Fitness-patented HILL workout offers a variety of configurations for interval training. Intervals are periods of intense cardiovascular exercise separated by regular periods of lower-intensity exercise. The WORKOUT PROFILE window represents these high and low intervals as columns of illuminated LEDs, which together have the appearance of hills and valleys. The computerized interval training workout has been scientifically demonstrated to promote greater cardiorespiratory improvement than steady-pace training.

The HILL workout goes through four phases, each marked by different intensity levels. The WORKOUT PROFILE window displays the progress of these phases. As noted in the descriptions below, the heart rate should be measured at two stages in the workout to gauge its effectiveness. Wear the Polar telemetry heart rate chest strap or continuously grip the Lifepulse handles. The MESSAGE CENTER does not display a request for a heart rate measurement, as it does with CARDIO, FAT BURN and the HEART RATE ZONE TRAINING programs.

1. **Warm-up** is a phase of low, gradually rising resistance, which brings the heart rate into the lower end of the target zone and increases respiration and blood flow to working muscles.
2. **Plateau** increases the intensity slightly and keeps it steady, to bring the heart rate to the low end of the target zone. Check the heart rate at the end of this phase.
3. **Interval Training** is a series of increasingly steeper hills alternating with valleys or stints of recovery. The heart rate should rise to the high end of the target zone. Check the heart rate at the end of this phase.
4. **Cool Down** is a low-intensity phase that allows the body to begin removing lactic acid and other exercise by-products which build up in muscles and contribute to soreness.

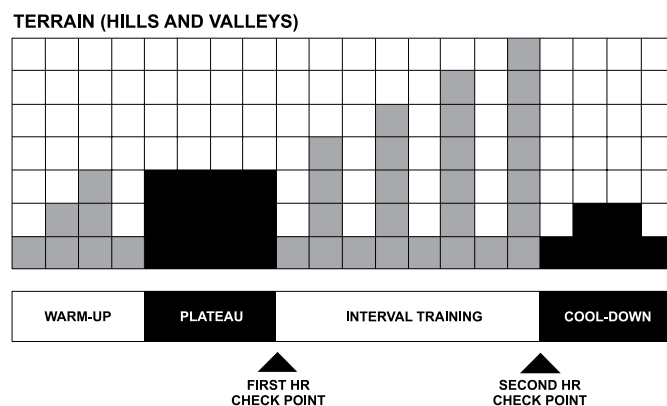

Each column, as seen in the WORKOUT PROFILE WINDOW and the chart above, represents one interval. The overall duration of the workout determines the length of each interval. Each workout is made up of 20 intervals, so the duration of each interval is equal to the duration of the entire workout divided by 20.

1 to 9 minutes: A workout with a duration of less than 10 minutes is insufficient for the HILL program to complete all four phases adequately. The program therefore condenses a workout of this duration at various stages.

10 to 19 minutes: The interval durations initially are set at 30 seconds for a 10-minute workout. For every minute over 10, each interval increases by three seconds. A 15-minute workout consists of 20 intervals at 45 seconds each.

20 to 99 minutes: All intervals last 60 seconds. If the user adds minutes to the pre-set duration while the workout is in progress, the program adds hills and valleys that are identical to the first eight intervals of the Interval Training phase. This pattern repeats until the workout is completed.

HEART RATE HILL™

This program combines the standard HILL workout profile with the concept of Heart Rate Zone Training. The default target heart rate is calculated as 80% of the theoretical maximum (HRmax), but the user can adjust the target rate during the workout setup. All hills and valleys are percentages of HRmax. The workout consists of three hills that target three heart rate goals:

- The first hill brings the heart rate to 70% of HRmax.
- The second hill increases the rate to 75% of HRmax.
- The third hill matches the Target Heart Rate bringing the heart rate to 80% of HRmax.

The valley always is defined as 65% of HRmax.

After a standard three-minute warm-up, the workout progresses toward the first hill and heart rate goal. Once the user reaches 70% of HRmax, the hill continues for one minute. When the minute expires, the level decreases into a valley. Once the user's heart rate falls to 65% of HRmax, the valley continues for one minute. Then, the next hill begins with its corresponding heart rate goal. After the user completes the third hill/valley pair, the program returns to the first hill and repeats the cycle as long as the duration allows. At the end of the duration, the workout goes into a cool down phase. If the heart rate goes above the theoretical maximum for more than 45 seconds, the bike automatically goes into pause mode. The program does not proceed to a new heart rate goal until the user reaches the current goal.

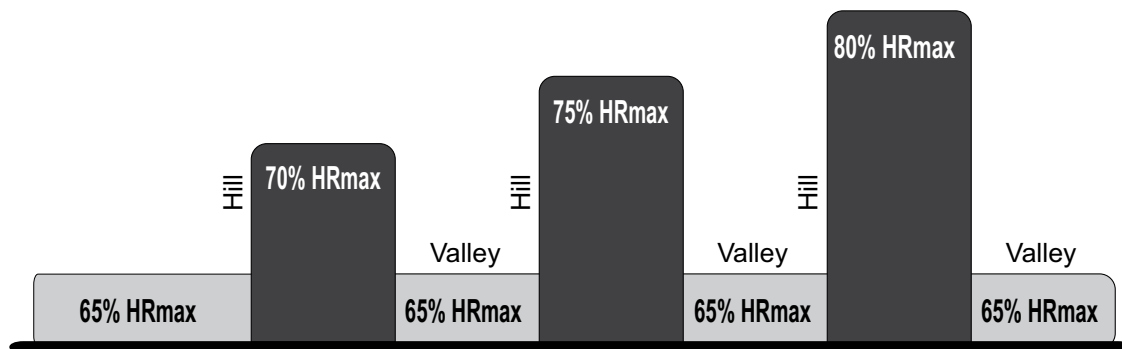

HEART RATE HILL Workout Profile

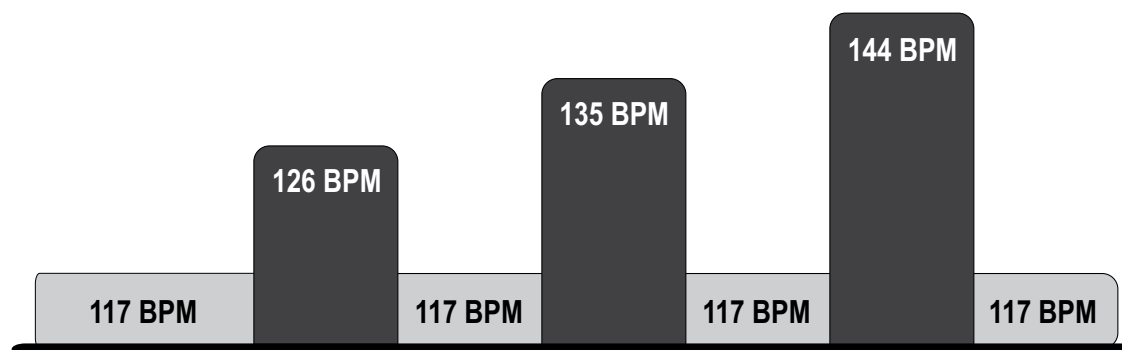

User Example: 80 percent of theoretical maximum (HRmax) (40 year old / 144 recommended BPM)

HEART RATE INTERVAL™

This program also combines the standard HILL workout profile with the concept of Heart Rate Zone Training. The default target heart rate is calculated as 80% of the theoretical maximum (HRmax), but the user can adjust the target rate during the workout setup. The workout alternates between a hill, which brings the heart rate up to the target rate of 80% of HRmax, and a valley which brings the heart rate down to 65% of HRmax. After a standard three-minute warm-up, the workout progresses toward the first hill and heart rate goal. Once the goal is reached, the hill continues for three minutes, then the level decreases into a valley. Once the 65% of HRmax goal is reached, the valley continues for three minutes, after which the next hill begins. The user's fitness level determines the number of hills and valleys encountered within the duration. At the end of the duration, the workout goes into a cool down phase. If the heart rate goes above the theoretical maximum for more than 45 seconds, the bike automatically goes into pause mode. The program does not proceed to a new heart rate goal until the user reaches the current goal.

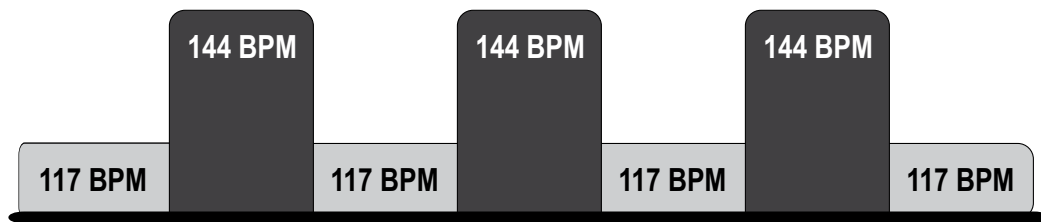
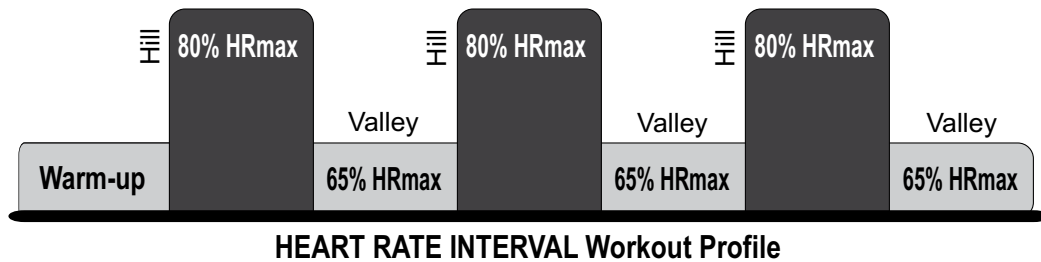

User Example: 80 percent of theoretical maximum (HRmax) (40 year old / 144 recommended BF

EXTREME HEART RATE™

This intense, varied workout is designed to help more experienced users to break through fitness improvement plateaus. The workout alternates between two target heart rates as quickly as possible. The effect is similar to that of running sprints. The user must wear a Polar telemetry heart rate chest strap or grip the Lifepulse sensors throughout the workout.

When setting up the workout, the user enters a target heart rate. After a standard three-minute warm-up, the intensity increases, until the user reaches the target heart rate goal of 85% of the theoretical maximum (HRmax). That target rate is maintained for a stabilizing period. Then, the intensity decreases. When the heart rate falls to the 65% of HRmax goal, it is maintained there for a stabilizing period. The program repeats the alternating intensity levels, continuing this pattern throughout the duration. The program does not proceed to a new heart rate goal until the user reaches the current goal.

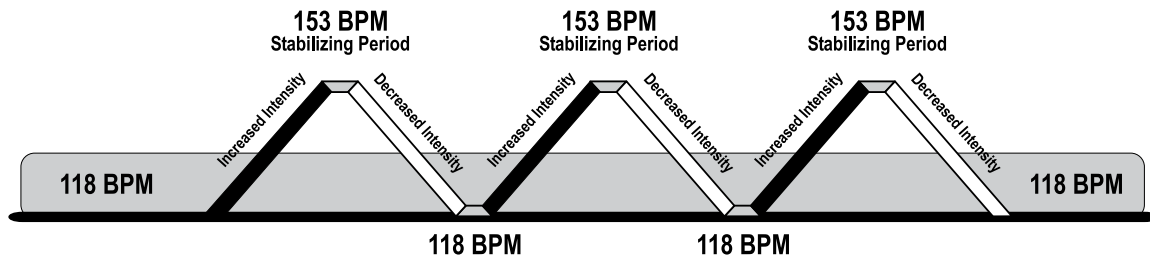
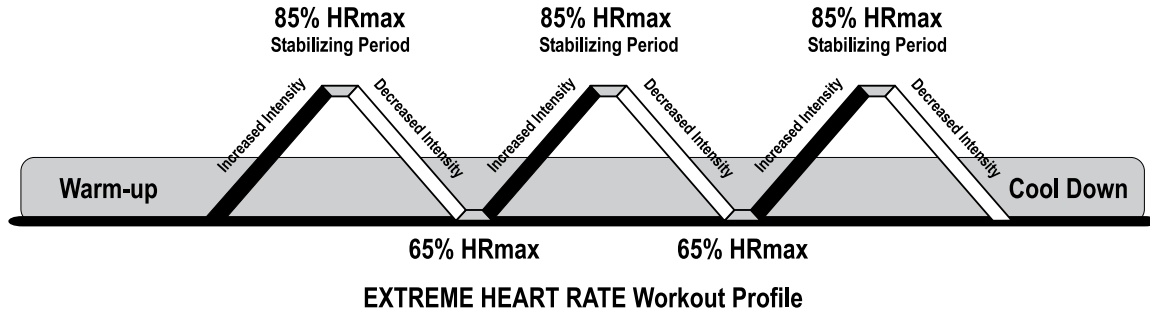

User Example 85 percent of theoretical maximum (HRmax) (40 year old / 153 recommended BPM)

WATTS

This workout targets a rate of effort equal to a certain number of Watts. A Watt is a unit of power that measures the amount of mechanical work required to operate a device, such as a Lifecycle exercise bike. It is roughly equal to 0.25 calories per hour. The workout program automatically alters the intensity level to maintain the appropriate rate of effort. By default, this workout is turned off. For information on making it available, see Section 5, *System Menu*.

METS

This workout targets a rate of effort equal to a certain number of METs. A MET is a unit of measurement used to express the metabolic rate of work (oxygen consumption per unit of body weight) required to perform a task. One MET is approximately equal to a person's metabolism when seated and relaxed. By default, this workout is turned off. For information on making it available, see Section 5, *Optional Settings*.

AEROBICS TRAINER

In this workout, the MESSAGE CENTER continuously prompts the user to switch between a high pedaling speed and a slow pedaling speed. These speed intervals alternate in a pattern that promotes a "build-up" in the intensity of the workout, followed by a "build-down" in intensity. The workout consists of 32 intervals, which are divided into groups of four. In the first group, the user encounters one fast interval followed by three slow intervals. The second group features two fast intervals followed by two slow intervals. The third group features three fast intervals followed by one slow interval. The fourth group, which is the most intense point of the workout, features four fast intervals. Afterward, the workout decreases in intensity, concluding with a group of four, consecutive, slow intervals. See the chart below:

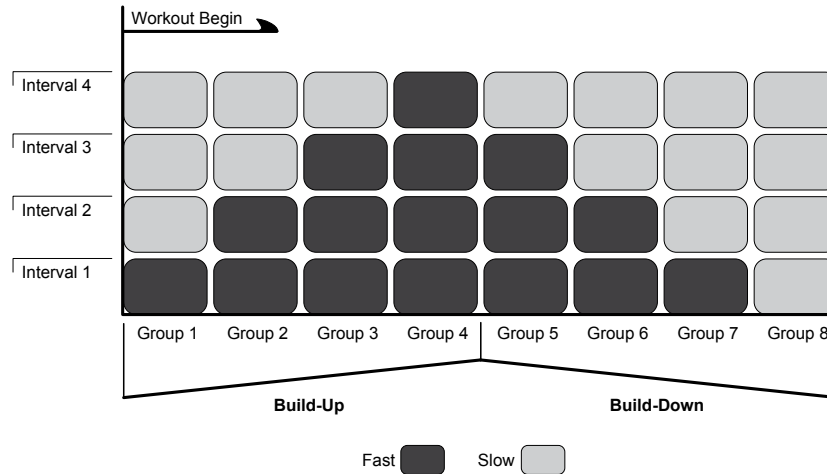

The length of the intervals depends on the workout duration selected by the user.

FIT TEST

The Life Fitness Fit Test program is another exclusive feature of this product. The Fit Test workout estimates cardiovascular fitness and can be used to monitor improvements in endurance every four to six weeks. The user must grasp the Lifepulse hand sensors when prompted or wear a heart rate chest strap, as the test score calculation is based on a heart rate reading. The workout duration will be five minutes at the chosen resistance level. Immediately afterward, the console will take the user's heart rate reading, calculate a fitness score, and display the score in the MESSAGE CENTER.

The Fit Test is considered to be a submax VO_2 (volume of oxygen) test. It gauges how well the heart supplies oxygenated blood to the exercising muscles, and how efficiently those muscles receive oxygen from the blood. Physicians and exercise physiologists generally regard this test as a good measure of aerobic capacity. Please note that the estimated VO_2 max scores achieved will be 10 percent to 15 percent lower on stationary exercise bikes than those achieved on other Life Fitness cardiovascular equipment. Stationary cycling has a higher rate of isolated muscle fatigue of the quadriceps when compared to walking/running on a treadmill, climbing on a stairclimber, or utilizing a bike. This higher rate of fatigue corresponds to lower levels of estimated VO_2 max scores.

To set up the Fit Test:

- Begin pedaling.
- Press the WORKOUT PROFILES button repeatedly until the FIT TEST option appears in the MESSAGE CENTER. Press ENTER to select the FIT TEST option.
- The MESSAGE CENTER will prompt for a user weight (ENTER WEIGHT). Use the ARROW KEYS to input your weight. Press ENTER to accept the weight.
- The MESSAGE CENTER will next prompt for a user age (ENTER AGE). Use the ARROW KEYS to input your age. Press ENTER to accept the age.
- The MESSAGE CENTER will next prompt for a user gender (SELECT GENDER). Using ARROW KEYS, select a gender. Press ENTER to accept the gender selection.
- The MESSAGE CENTER will next prompt for a workout level (ENTER LEVEL). Consult the following recommended fit test level chart for an appropriate effort level based on your age, gender and activity level. Use the ARROW KEYS to enter the corresponding level.

After the five-minute FIT TEST is completed, a FIT TEST score will be displayed.

Fit Test Program Suggested Exertion Levels

	Inactive	Active	Very Active
Lifecycle Bike Fit Test Level	L 4-6 men	L 5-10 men	L 8-14men
	L 2-4 women	L 3-7 women	L 6-10 women

Suggested exertion levels should be used as a guideline for setting up the Fit Test program. The goal is to elevate the user's heart rate to a level that is between 60%-85% of their theoretical maximum heart rate.

Within each suggested range, these additional guidelines can be used:

Lower Half of Range	Upper Half of Range
higher age	lower age
lower weight	higher weight*
shorter	taller

* In cases of excessive weight, use lower half of range

The computer will not accept:

- heart rates less than 52 or greater than 200 beats per minute
- body weights less than 75 pounds (34 kg) or greater than 400 pounds (181 kg)
- ages below 10 or over 99 years
- data input that exceeds human potential

If you make an error when entering any Fit Test data, you can correct it by pressing CLEAR, inputting the correct information, and pressing ENTER.

It is important for you to take the Fit Test under similar circumstances each time. Your heart rate is dependent on many factors, including:

- amount of sleep the previous night (at least seven hours is recommended)
- time of day
- time you last ate (two to four hours after the last meal is recommended)
- time since you last drank a liquid containing caffeine or alcohol, or smoked a cigarette (at least four hours is recommended)
- time since you last exercised (at least six hours is recommended)

For the most accurate Fit Test results, you should perform the Fit Test on three consecutive days and average the three scores.

NOTE: To receive a proper Fit Test score, the work done must be within a training heart rate zone that is 60% to 85% of the theoretical maximum heart rate (HRmax). This program requires a constant exertion for accuracy, so it will not be allowed to resume if paused. This program will control level. Manual adjustment of level is not permitted.

The tables below list fit test results.

Relative Fitness Classification for MEN

Rating	<i>Elite</i>	<i>Excellent</i>	<i>Very Good</i>	<i>Above Average</i>	<i>Average</i>	<i>Below Average</i>	<i>Low</i>	<i>Very Low</i>
Estimated VO₂ Max (ml/kg/min) per Age category								
20 - 29 years	55+	53 - 54	50 - 52	45 - 49	40 - 44	38 - 39	35 - 37	<35
30 - 39 years	52+	50 - 51	48 - 49	43 - 47	38 - 42	36 - 37	34 - 35	<34
40 - 49 years	51+	49 - 50	46 - 48	42 - 45	37 - 41	34 - 36	32 - 33	<32
50 - 59 years	47+	45 - 46	43 - 44	39 - 42	34 - 38	32 - 33	29 - 31	<29
60+ years	43+	41 - 42	39 - 40	35 - 38	31 - 34	29 - 30	26 - 28	<26

Relative Fitness Classification for WOMEN

Rating	<i>Elite</i>	<i>Excellent</i>	<i>Very Good</i>	<i>Above Average</i>	<i>Average</i>	<i>Below Average</i>	<i>Low</i>	<i>Very Low</i>
Estimated VO₂ Max (ml/kg/min) per Age category								
20 - 29 years	47+	45 - 46	43 - 44	38 - 42	33 - 37	31 - 32	28 - 30	<28
30 - 39 years	44+	42 - 43	40 - 41	36 - 39	31 - 35	29 - 30	27 - 28	<27
40 - 49 years	42+	40 - 41	38 - 39	34 - 37	30 - 33	28 - 29	25 - 27	<25
50 - 59 years	37+	35 - 36	33 - 34	30 - 32	26 - 29	24 - 25	22 - 23	<22
60+ years	35+	33 - 34	31 - 32	27 - 30	24 - 26	22 - 23	20 - 21	<20

Life Fitness developed this rating scale based on VO₂ max percentile distributions referenced in *American College of Sports Medicine's Guidelines for Exercise Testing and Prescription* (8th E, 2010). It is designed to provide a qualitative description of a user's VO₂ max estimation, and a means of assessing initial fitness level and tracking improvement.

MILITARY FITNESS TEST

The Lifecycle® Exercise Bike features an Air Force Physical Readiness Tests (PRT). This test is similar to the fit test workout, except that it does not have a preset time goal.

To begin an Air Force PRT:

- Press the WORKOUTS PLUS button repeatedly until the AIR FORCE PRT appears in the MESSAGE CENTER and press ENTER to select the AIR FORCE PRT option.
- The MESSAGE CENTER will prompt for a user weight (ENTER WEIGHT). Enter a weight between 75 - 400 pounds using the ARROW keys. Press ENTER to accept the weight.
- The MESSAGE CENTER will prompt for a user height (ENTER HEIGHT). Enter a height between 36 - 90 inches using the ARROW keys. Press ENTER to accept the height.
- The MESSAGE CENTER will next prompt for a user age (ENTER AGE). Enter an age between 17 - 70 years using the ARROW keys. Press ENTER to accept the age.
- The MESSAGE CENTER will next prompt for a user gender (SELECT GENDER). Using the ARROW keys, select a gender. Press ENTER to accept the gender selection.
- The MESSAGE CENTER will next prompt for a user Fitness Level ("Do you perform Aerobic Activity at least 3 times per week"). Using the ARROW keys, select 'YES' or 'NO'. Press ENTER to accept the selection.

The Air Force PRT begins after the user selects their Fitness Level and presses ENTER. During the PRT the user must maintain 50-80 RPM. If the user pedals outside this range, a warning message is displayed. If the user continues to pedal outside this range for more than 10 seconds, the test is terminated. If the user's heart rate exceeds 85% of their theoretical maximum heart rate, the test is also terminated. The Air Force PRT requires a user's heart rate throughout the test. Heart rate is recorded every minute, and if it is not detected, the test will terminate. The PRT starts with a 2 minute warm-up. After this warm-up, an initial wattage setting is determined from the user's input data. The PRT then monitors a user's heart rate and determines if more resistance is needed. After 6 minutes at a constant wattage, the exercise bike will try to calculate a score.

4.4 Using My Workouts Personal Programs

The MY WORKOUTS personal programs feature on the Life Fitness Lifecycle exercise bike makes it possible to pre-set up to seven workouts with personal setup information, such as age or duration, and then store the workouts in the console memory. MY WORKOUTS is used to store statistics for up to 7 different users or profiles. These workouts are accessed with the CHANGE WORKOUTS key.

MY WORKOUTS allows the end-user to customize the set-up of a workout once and save it for quick start up. Any of the following workouts may be pre-set and stored: FAT BURN, CARDIO, HEART RATE HILL, HEART RATE INTERVAL, EXTREME HEART RATE, HILL, RANDOM, MANUAL, SPORT TRAINING, and EZ RESISTANCE. MY WORKOUTS allows the end user to view workout statistics overtime applicable to each saved profile.

My Workouts - Programming Options

Press the CHANGE WORKOUTS key. Scroll through the names displayed in the MESSAGE CENTER, by pressing the ARROW keys. When the desired name appears, press ENTER. The workout then begins. By factory default, the workouts are stored under the names MY WORKOUT 1 through MY WORKOUT 7. Each workout must be set up before it can be accessed. See the following section for steps to set up and change workouts stored under MY WORKOUTS.

Editing Settings for Workouts Saved Under My Workouts

Use the following steps to change settings for a stored workout or to change a workout name.

1. When the MESSAGE CENTER displays the prompt "SELECT WORKOUT USING ARROW KEYS OR PRESS QUICK START," press the CHANGE WORKOUTS key.
2. Scroll through the user names displayed in the MESSAGE CENTER by pressing the ARROW keys.
3. When the desired name appears, press the ENTER key.
4. The MESSAGE CENTER displays the prompt, "SELECT MY WORKOUTS OPTIONS USING ARROW KEYS - THEN PRESS ENTER". At this prompt, it is possible to select "MY WORKOUTS NAMING" to change a workout name, "MY WORKOUTS CREATION" to change settings for a workout, or "MY WORKOUT STATISTICS" to view statistics for a workout.

To Change Settings for a Stored Workout:

1. Select "MY WORKOUTS CREATION" and press ENTER.
2. Press ENTER to modify an existing workout, or press CLEAR to erase an existing workout.
3. Enter setup information as prompted by the MESSAGE CENTER. Use the ARROW keys to scroll through displayed values, and press ENTER to confirm the desired value. Once all information is entered, the MESSAGE CENTER displays WORKOUT SAVED.

To View Statistics for a Stored Workout:

1. Select "MY WORKOUT STATISTICS," and press ENTER.
2. Scroll through the statistic displays by pressing the ARROW keys.
3. Press ENTER or CLEAR to return to the MY WORKOUTS menu.

To Change a Workout Name:

1. Select "MY WORKOUTS NAMING," and press ENTER
2. The MESSAGE CENTER displays the prompt, "SELECT LETTER USING CHANGE WORKOUT KEY AND CHANGE LETTER USING ARROW KEYS." The workout name appears in the MESSAGE CENTER, with the first letter blinking. Scroll to the desired letter, number, or punctuation symbol, using the ARROW key. When the desired character appears, press CHANGE WORKOUT to move on to the next letter. Repeat this step for all characters. Press the WORKOUTS PLUS key to move back one letter.
3. Press ENTER to save the new name. The MESSAGE CENTER displays, "NAME SAVED."

5 System Menu

A special system menu is available to equipment owners and other authorized personnel to allow access to certain information, diagnostics tests and configuration settings.

5.1 Entering and Using the System Menu

The System Menu consists of 3 submenus including the Information submenu, Diagnostic submenu and Configuration submenu. To enter the System Menu press and hold down the UP ARROW key and then press the CLEAR key twice. Continue to hold down the UP ARROW key until the MESSAGE CENTER displays the words CODE VER.X.XX. This is the Information Menu which is the default submenu of the System Menu.

Information Menu (CODE VER X.XX)

The Information submenu will display information identifying the software version numbers and their associated part numbers as well as the version numbers of other installed software components. Use this menu when it is necessary to identify the version / part numbers installed on the product. The UP and DOWN arrow keys can be used to navigate through the list of items that may be displayed. Press the CLEAR key once to exit the Information Menu and hence the System Menu.

Diagnostics Menu (SERVICE MENU)

The Diagnostics submenu allows technicians to run system diagnostics. This menu can be entered from the Information Menu by pressing and holding the COOL DOWN key then pressing the ENTER key. The MESSAGE CENTER will display the words SERVICE MENU. Pressing the ENTER key will navigate forward through the list of diagnostic utilities while pressing the CLEAR key will navigate backward. Use the CLEAR key repeatedly to exit the Diagnostic Menu.

Configuration Menu (OPTIONAL SETTINGS)

The Configuration submenu allows the owner to configure options for the product. This menu can be entered from the Information Menu by pressing the ENTER key. The MESSAGE CENTER will display the words OPTIONAL SETTINGS. Pressing the ENTER key will navigate forward through the list of optional settings while pressing the CLEAR key will navigate backward. Use the CLEAR key repeatedly to exit the Configuration Menu. See the next page for a list of configuration options (Optional Settings).

5.2 Manager's Configuration (Optional Settings)

Setting	Default	Description
Maximum Workout Duration	60 Minutes	This feature allows the setting of maximum workout duration limits.
English / Metric Units	English (International: Metric)	This option sets the measurement unit type for weight, distance, and speed.
Pause Timeout	5 Minutes	This sets the maximum time during which a workout can remain in pause mode. <i>(Available on externally powered units)</i>
WATTS Display	Off (International: On)	If this option is enabled, the MESSAGE CENTER displays the Watts equivalent of the pedal rate.
METS Display	Off	If this option is enabled, the MESSAGE CENTER displays the METs equivalent of the pedal rate.
WATTS Program	Disabled	If this option is enabled, the WATTS program becomes an available workout on the bike.
METS Program	Disabled	If this option is enabled, the WATTS program becomes an available workout on the bike.
Calorie Per Hour (CPH) Display	On (International: Off)	If this option is enabled, the MESSAGE CENTER displays the number of calories burned per hour during the workout.
Sleep Mode	Off	The Sleep Time configuration setting controls how long the console will stay powered up from the last key press but before actively engaging the product in exercise. This configuration applies to externally powered products only. Upon entry to this utility the current configuration setting shall be displayed. The UP / DOWN arrow keys shall allow incrementing/ decrementing of the Sleep Time value in 1 minute increments respectively. The range of values for Sleep Time shall be 1 through 99 minutes and OFF.
Air Force PRT	On	If this option is enabled by selecting the On setting, the FITNESS TEST: AIR FORCE PRT program becomes unavailable workout on the bike.

6 Service and Technical Data

6.1 Preventive Maintenance Tips

The Life Fitness exercise bike is backed by the engineering excellence and reliability of Life Fitness and is one of the most rugged and trouble-free pieces of exercise equipment on the market today.

NOTE: *Safety of the equipment can be maintained only if the equipment is examined regularly for damage or wear. Keep the equipment out of use until defective parts are repaired or replaced. Pay special attention to parts that are subject to wear, as outlined below.*

REMARQUE: *pour conserver un matériel sûr, il convient de l'inspecter régulièrement afin de déceler tout signe d'usure ou d'endommagement. N'utilisez pas l'appareil tant que les pièces défectueuses n'ont pas été réparées ou remplacées. Portez une attention toute particulière aux pièces qui s'usent, comme indiqué ci-dessous.*

The following preventive maintenance tips will keep the Life Fitness product operating at peak performance:

- Locate the Life Fitness Lifecycle bike in a cool, dry place.
- Keep the pedal straps fastened securely when using the bike.
- Clean the top surface of the pedals regularly.
- Keep the display console free of fingerprints and salt build-up caused by sweat.
- Clean the display console and all exterior surfaces with an approved or compatible cleaner (see *Life Fitness Approved Cleaners*) and a soft cotton cloth.
- Long fingernails may damage or scratch the surface of the console; use the pad of the finger to press the selection buttons on the console.
- Clean the housing thoroughly on a regular basis.

Life Fitness Approved Cleaners (United States Availability Only)

Two preferred cleaners have been approved by Life Fitness reliability experts: PureGreen 24 and Gym Wipes. Both cleaners will safely and effectively remove dirt, grime and sweat from equipment. PureGreen 24 and the Antibacterial Force formula of Gym Wipes are both disinfectants that are effective against MRSA and H1N1. PureGreen 24 is available in a spray which is convenient for gym staff to use. Apply the spray to a microfiber cloth and wipe down the equipment. Use PureGreen 24 on the equipment for at least 2 minutes for general disinfection purposes and at least 10 minutes for fungus and viral control. Gym Wipes are large, durable pre-moistened wipes to use on the equipment before and after workouts. Use Gym Wipes on the equipment for at least 2 minutes for general disinfection purposes.

Contact Customer Support Services to order these cleaners (1-800-351-3737 or email: customersupport@lifefitness.com).

Life Fitness Compatible Cleaners

Mild soap and water or a mild non-abrasive household cleaner can also be used to clean the display and all exterior surfaces. Use a soft microfiber cloth only. Apply the cleaner to the microfiber cloth before cleaning. DO NOT use ammonia or acid based cleaners. DO NOT use abrasive cleaners. DO NOT use paper towels. DO NOT apply cleaners directly to the equipment surfaces.

6.2 Preventive Maintenance Schedule

Item	Weekly	Monthly	Biannually
<i>Console Overlay</i>	Clean		Inspect
<i>Bottle Holders</i>	Clean	Inspect	
<i>Console Mounting Bolts</i>			Inspect
<i>Frame</i>	Clean		Inspect
<i>Plastic Covers</i>	Clean	Inspect	Inspect
<i>Lifepulse Sensors</i>	Clean / Inspect		
<i>Pedals and Straps</i>	Clean	Inspect	

6.3 Troubleshooting the Optional Polar® Telemetry Heart Rate Chest Strap

Malfunction	Probable Cause	Corrective Action
Heart rate reading is initially detected and functioning normally but then is lost.	Use of personal electronic devices, such as cell phones and portable MP3 players, causes external noise interference.	Remove the source of noise or reposition the exercise equipment.
	Equipment is in close proximity to other sources of noise such as audio/ video equipment, fans, two way radios, and high voltage/high current power lines.	
Heart rate readings are abnormally elevated.	Television sets and/or antennas generate electromagnetic interference.	Move the bike a few inches away from the probable cause, or move the probable cause a few inches away from the bike until the heart rate readings are accurate.
	Cell phones generate electromagnetic interference.	
	Computers generate electromagnetic interference.	
	Cars generate electromagnetic interference.	
	High voltage power lines generate electromagnetic interference.	
	Motor driven exercise equipment generates electromagnetic interference. Another heart rate transmitter within 3 feet (1 meter) generates electromagnetic interference.	
Heart rate reading is erratic or absent entirely.	Belt transmitter electrodes are not wet enough to pick up accurate heart rate readings.	Wet the belt transmitter electrodes (see Section 3.2).
	Belt transmitter electrodes are not laying flat against the skin.	Ensure the belt transmitter electrodes are laying flat against the skin (see Section 3.2).
	Belt transmitter needs cleaning.	Wash the belt transmitter with mild soap and water.
	Belt transmitter is not within 3 feet (1 meter) of the heart rate receiver.	Make sure the chest strap transmitter is within 3 feet (1 meter) of the heart rate receiver.
	Polar telemetry heart rate chest strap battery is depleted.	Contact Life Fitness Customer Support Services for instructions on how to have the Polar telemetry heart rate chest strap replaced.
	Polar telemetry heart rate chest strap did not lock in with the heart rate receiver.	<p>Make sure the Polar telemetry heart rate chest strap is applied and move closer to the heart rate receiver. Wait up to 10 seconds for the heart rate to display on the console.</p> <p>NOTES:</p> <ol style="list-style-type: none"> 1. Ensure proper adherence of the Polar telemetry heart rate chest strap to user's chest. 2. Ensure proper conductivity between the electrodes and user's chest. 3. If needed, use the Polar watch to verify chest strap's operation.

6.4 Troubleshooting the Lifepulse System Sensors

If the heart rate reading is erratic or missing, do the following:

- Dry the hands if necessary to prevent slipping.
- Apply hands to both sensors; one in each hand.
- Grasp the sensors firmly.
- Apply constant pressure around the sensors.

6.5 How to Obtain Product Service / Serial Number Location

1. Verify the symptom and review the operating instructions. The problem may be unfamiliarity with the product and its features and workouts.
2. Locate and write down the serial number of the unit which is located on the front stabilizer at the bottom of the unit.
3. Contact Life Fitness Customer Support Services.

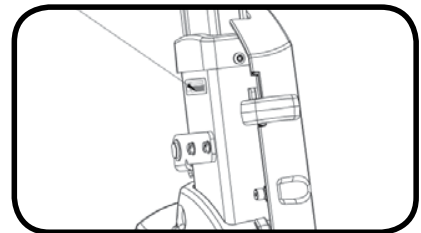
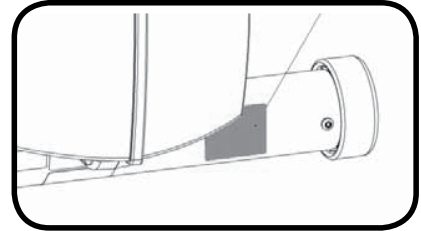

Remove plastic shroud to find the small serial label location.

6.6 Recycling the Battery

When this Life Fitness product is about to be discarded at the end of its useful life, the rechargeable battery must first be removed and recycled. If an optional external power supply is present, it must be disconnected before the battery is removed. To access the battery, remove the right-side pedal crank and shroud. To remove the battery, disconnect the cable, and remove the two screws holding the battery to the bracket.

7 Specifications

Designed Use:	Home
Maximum User Weight:	400 pounds / 181 kilograms
Power Requirements:	None
Console Displays:	Elapsed time, total distance, total calories burned, calories burned per hour, heart rate, target heart rate, Watts, METS, workout profile, resistance level, RPM
Workouts, Goals & Modes:	Quick Start, Manual, Cardio, Fat Burn, Heart Rate Hill™, Heart Rate Interval™, Extreme Heart Rate™, Random, Hill, Time-based Goal, My Workout Programs (7), Life Fitness Fit Test, Air Force PRT, Cool Down Mode, Speed Training, Around the World, Cascades, Foothills, Interval, Kilimanjaro, Watts, METS, Aerobics Trainer, EZ Resistance, Sport Training, Bike Mode, Constant Calories Per Hour Mode
Intensity Levels:	20
Pedal Size:	5 in. x 5.5 in. (127 mm x 140 mm)
Drive Type:	Belt / alternator
Heart Rate Monitoring Systems:	Patented Lifepulse™ digital contact heart rate and Polar® telemetry-compatible heart rate monitoring system
Ports (2):	Type RJ45, interchangeable Network ready connection and Fitness Entertainment port (power compliant with FitLinxx CSAFE specification dated August 4, 2004: 4.75VDC to 10VDC; maximum current of 85mA).
Mobile Device Charging:	5Vdc @ 500mA
Headphone Jack:	3.5mm Stereo, 150mW max

Physical Dimensions
Length: 46.5 in. (118.11 cm) <i>with console</i>
Width: 24 in. (61 cm)
Height: 56.75 in. (144.15 cm) <i>with console</i>
Weight: 114 lbs. (51.71 kg) 118 lbs. (53.52 kg) <i>with console</i>
Shipping Dimensions (without console)
Length: 48 in. (122 cm)
Width: 22 in. (56 cm)
Height: 37 in. (94 cm)
Weight: 132 lbs. (59.88 kg)

8 Warranty

Model	2 Years	1 Year	6 Months
CSLU Bike	<ul style="list-style-type: none"> Electrical & Mechanical Parts 	<ul style="list-style-type: none"> Labor 	<ul style="list-style-type: none"> Console Overlay Shrouds

WHAT IS COVERED:

This Life Fitness consumer product ("Product") is warranted to be free of all defects in material and workmanship.

WHO IS COVERED:

The original purchaser or any person receiving a newly purchased Product as a gift from the original purchaser. Warranty will be voided on subsequent transfers.

HOW LONG IS IT COVERED:

Residential: All electrical and mechanical components and labor are covered, after the date of purchase, as listed on the chart above.

Non-Residential: Warranty void (this Product is intended for residential use only).

WHO PAYS SHIPPING & INSURANCE FOR SERVICE:

If the Product or any warranted part must be returned to a service facility for repairs, Life Fitness will pay all shipping and insurance charges during the warranty period (*within the United States only*). The purchaser is responsible for shipping and insurance charges after the warranty has expired.

WHAT WE WILL DO TO CORRECT COVERED DEFECTS:

We will ship to you any new or rebuilt replacement part or component, or, at our option, replace the Product. Such replacement parts are warranted for the remaining portion of the original warranty period.

WHAT IS NOT COVERED:

Any failures or damage caused by unauthorized service, misuse, accident, negligence, improper assembly or installation, debris resulting from any construction activities in the Product's environment, rust or corrosion as a result of the Product's location, alterations or modifications without our written authorization or by failure on your part to use, operate and maintain the Product as set out in your User Manual ("Manual"). All terms of this warranty are void if this Product is moved beyond the continental borders of the United States of America (excluding Alaska, Hawaii and Canada) and are then subject to the terms provided by that country's local authorized Life Fitness Representative. Two type RJ45 interchangeable Network ready and Fitness Entertainment ports are supplied with the Product. These ports comply with the FitLinxx CSAFE specification dated August 4, 2004 stating: 4.75VDC to 10VDC; maximum current of 85mA. Any Product damage caused by a load exceeding this FitLinxx CSAFE specification is not covered by warranty.

WHAT YOU MUST DO:

Retain proof of purchase. Use, operate and maintain the Product as specified in the Manual; notify the place of purchase of any defect within 10 days after discovery of the defect; if instructed, return any defective part for replacement or, if necessary, the entire Product for repair. Life Fitness reserves the right to decide whether or not a product is to be returned for repair.

USER MANUAL:

It is VERY IMPORTANT THAT YOU READ THE MANUAL before operating the Product. Remember to perform the periodic maintenance requirements specified in the Manual to assure proper operation and your continued satisfaction.

PRODUCT REGISTRATION:

Register online at www.lifefitness.com/home/product-registration.html. Our receipt assures that your name, address and date of purchase are on file as a registered owner of the Product. Being a registered owner assures coverage in the event you lose your proof of purchase. Please retain your proof of purchase, such as your bill of sale or receipt.

HOW TO GET PARTS & SERVICE:

Refer to page one of this manual for your local service contact information. Reference your name, address and the serial number of your Product (*consoles and frames have separate serial numbers*). They will tell you how to get a replacement part, or, if necessary, arrange for service where your Product is located.

EXCLUSIVE WARRANTY:

THIS LIMITED WARRANTY IS IN LIEU OF ALL OTHER WARRANTIES OF ANY KIND EITHER EXPRESSED OR IMPLIED, INCLUDING BUT NOT LIMITED TO THE IMPLIED WARRANTIES OF MERCHANTABILITY AND FITNESS FOR A PARTICULAR PURPOSE, AND ALL OTHER OBLIGATIONS OR LIABILITIES ON OUR PART. We neither assume nor authorize any person to assure for us any other obligation or liability concerning the sale of this Product. Under no circumstances shall we be liable under this warranty, or otherwise, of any damage to any person or property, including any lost profits or lost savings, for any special, indirect, secondary, incidental or consequential damages of any nature arising out of the use of or inability to use this Product. Some states do not allow the exclusion or limitation of implied warranties or of liability for incidental or consequential damages, so the above limitations or exclusions may not apply to you. Warranties may vary outside the U.S. Contact Life Fitness for details.

CHANGES IN WARRANTY NOT AUTHORIZED:

No one is authorized to change, modify or extend the terms of this limited warranty.

EFFECT OF U.S. STATE LAWS:

This warranty gives you specific legal rights and you may have other rights which vary from state to state.