



TEMPO 2+2 GASOLINE Operators Manual



**APPLICABLE TO TEMPO 2+2 ECH440 EFI GASOLINE
VEHICLES WITH PREFIX OF BY**

INTRODUCTION

VEHICLE OWNERSHIP

Congratulations! The Club Car brand is widely recognized as the industry leader in vehicle efficiency and long-lasting value. Read, understand, and obey the technical content in this manual to protect your investment and provide years of reliable vehicle operation.

Read, understand, and obey all instructions and safety precautions in this manual to prevent the risk of personal injury or property damage.

Club Car recommends owners that rent or loan vehicles make sure operators read this manual before vehicle operation.

Club Car recommends owners register their vehicles immediately after purchase. The previous owner must include this manual with the vehicle when sold to a new owner. Registration of the vehicle will make sure Club Car is able to communicate necessary information directly to owners. Send your name, address, and serial number of the vehicle to:

Club Car, LLC
Attention: Vehicle Registration
P.O. Box 204658
Augusta, Georgia 30917-4658
United States Of America

CALIFORNIA PROPOSITION 65

 **WARNING**

OPERATING, SERVICING AND MAINTAINING A PASSENGER VEHICLE OR OFF-ROAD VEHICLE CAN EXPOSE YOU TO CHEMICALS INCLUDING ENGINE EXHAUST, CARBON MONOXIDE, PHTHALATES, AND LEAD, WHICH ARE KNOWN TO THE STATE OF CALIFORNIA TO CAUSE CANCER AND BIRTH DEFECTS OR OTHER REPRODUCTIVE HARM. TO MINIMIZE EXPOSURE, AVOID BREATHING EXHAUST, DO NOT IDLE THE ENGINE EXCEPT AS NECESSARY, SERVICE YOUR VEHICLE IN A WELL-VENTILATED AREA AND WEAR GLOVES OR WASH YOUR HANDS FREQUENTLY WHEN SERVICING YOUR VEHICLE. FOR MORE INFORMATION GO TO WWW.P65WARNINGS.CA.GOV/PASSENGER-VEHICLE.

APPROVED DEALERS AND DISTRIBUTORS

Club Car's customer support system offers fast and courteous service. Speak with your dealer or distributor for:

- Accessories
- Publications
- Replacement Parts
- Technical Advice
- Warranty Work



To find your nearest dealer or distributor:

- Visit www.clubcardealer.com
- Scan the dealer locator Quick Response (QR) code

COMPANY CONTACT INFORMATION

Send written correspondence to:

Club Car, LLC
Attention: Marketing Services
P.O. Box 204658
Augusta, Georgia 30917-4658
United States Of America

SATISFACTION AND FEEDBACK

Let your voice be heard!

Your feedback will help improve our publications. You can access the survey through any internet-connected device with a web browser. The survey is available in many different languages.

Scan the Quick Response (QR) code or type the web address <http://bit.ly/1w9uFMh> to complete the survey.



NOTICES

VEHICLE MODEL AND SERIAL NUMBER

The vehicle serial number is located on a bar code decal installed below the passenger-side cup holder.

1. A two-letter code that identifies the vehicle model.
2. A four-digit code that identifies the model year and production week the vehicle was assembled.
3. A unique six-digit number given to each vehicle built within a specified model year.



LIABILITY AND VEHICLE DESIGN CHANGES

Club Car is not liable for errors in this manual or for incidental or consequential damages that result from the use of the material in this manual.

Club Car reserves the right to make design changes to vehicles without obligation to make these changes on units previously sold.

This manual is the original instructions provided by the manufacturer if in English. This manual is a translation of the original instructions if in any language other than English.

VEHICLE MODIFICATIONS

DANGER

MODIFICATIONS OR CHANGES TO THE VEHICLE THAT AFFECT THE OCCUPANT RETENTION, ELECTRICAL SYSTEM, STABILITY OR HANDLING OF THE VEHICLE, OR INCREASES THE MAXIMUM VEHICLE SPEED CAN CAUSE SERIOUS PERSONAL INJURY OR DEATH.

CAUTION

THE FUEL SYSTEM AND ENGINE ON YOUR VEHICLE ARE DESIGNED AND BUILT TO GOVERNMENT EMISSIONS STANDARDS. TAMPERING BY DEALERS, CUSTOMERS, OPERATORS, AND USERS IS STRICTLY PROHIBITED BY LAW. FAILURE TO COMPLY COULD RESULT IN GOVERNMENT FINES, REWORK CHARGES, INVALID WARRANTY, LEGAL ACTION, AND POSSIBLE CONFISCATION OF THE VEHICLE UNTIL REWORK TO ORIGINAL CONDITION IS COMPLETED. ENGINE SERVICE AND REPAIRS MUST BE DONE BY A TRAINED TECHNICIAN ONLY.

NOTICE

MODIFICATIONS TO THE GOVERNOR WILL VOID THE WARRANTY AND DAMAGE THE ENGINE AND OTHER COMPONENTS. DO NOT MODIFY THE GOVERNOR.

MODIFICATIONS TO THE VEHICLE MUST NOT COMPROMISE COMPLIANCE WITH STATE OR FEDERAL REGULATIONS.

Modifications made to vehicles or installation of accessories that are not approved by Club Car may adversely affect the safe operation and performance of the vehicle. These modifications include, but are not limited to lift kits, seating changes, increased speed and cargo capacity. Club Car does not recommend any modification of this vehicle except kits and upgrades specifically designed and offered by Club Car. However, if the vehicle is modified, the modifier shall:

1. arrange for the modification to be designed, tested and implemented by an engineer with expertise in vehicles and their safety;
2. maintain a permanent record of the design, testing and implementation of the modification;
3. make appropriate changes to the capacity, plate(s), decals, and operation and maintenance manuals; and
4. apply a permanent and readily visible label on the vehicle stating the vehicle has been modified with the date of the modification and the name of the entity that made the modification.

The entity making any modification becomes the original equipment manufacturer of the modified vehicle, assumes liability for the vehicle, and has the responsibilities listed above.

Modifications may void the warranty. Refer to the warranty for more details.

VEHICLE WARRANTY

Warranty information is located in the warranty section of this manual. No other expressed or implied warranties are contained herein.

Your dealer or distributor examined the vehicle before it was delivered to you. The dealer or distributor will also supply you a copy of the completed vehicle warranty registration form.

GOVERNMENTAL AND INDUSTRY STANDARDS

AMERICAN NATIONAL STANDARDS INSTITUTES ANSI Z135

When correctly equipped, this vehicle complies with American National Standards Institutes (ANSI) Z135 Safety Standards for Personal Transport Vehicles (PTVs). The vehicle should only be operated in areas approved for PTV operation. The words "PTV" and "vehicle" are used inter-changeably in this manual.

U.S.A. FEDERAL VEHICLE SAFETY STANDARDS

The configuration of this vehicle does not comply with United States Of America Federal Motor Vehicle Safety Standards (FMVSS) for automobiles and FMVSS 500 for low-speed vehicles as it existed on the date the vehicle was shipped from the Club Car manufacturing facility.

CANADIAN STANDARD ICES-002

This vehicle complies with CAN ICES-2 / NMB-2 as it was on the date the vehicle was shipped from the Club Car manufacturing facility.

EUROPEAN UNION VIBRATION AND NOISE PREN 15997

European Union specification prEN 15997 was used to measure the vibration and noise levels of the vehicle. The vibration and noise values are recorded in the vehicle specification section of this manual.

EUROPEAN UNION DIRECTIVES

This vehicle, when marked with a CE decal, complies with:

- 2014/30/EU
- 2006/42/EC

The following standards were used:

- EN ISO 12100:2010
- EN ISO 13857:2008



- EN ISO14982:2009

PUBLICATION COPYRIGHT

This manual contains proprietary information that is protected by copyright. All rights are reserved. Express written consent of Club Car, LLC is necessary to photocopy, replicate, or translate this manual. The information contained in this publication is subject to change without notice.

(Page intentionally left blank.)

CONTENTS

INTRODUCTION	I
---------------------------	----------

NOTICES	III
----------------------	------------

SECTION 1 – SAFETY INFORMATION	11
---	-----------

General Safety Information	12
Note To The Owner	12
Practice Safety.....	12
Safety Signal Words	12
Safety Committee	13
Vehicle Safety Information.....	13
Vehicle Safety And Compliance Decals.....	14
Vehicle Safety Features	18
Multi-Purpose Buzzer	18
Battery Safety Information	18
Battery International Safety Symbols	18
Lead-Acid Battery Recycling	19

SECTION 2 – INDICATORS, GAUGES, AND DISPLAYS	21
---	-----------

Indicator, Gauge, And Display Locations	22
Fuel Gauge/Hour Meter	22
Low Oil Warning Light	22
Malfunction Indicator Light	23

SECTION 3 – VEHICLE CONTROLS.....	25
--	-----------

Vehicle Controls Locator	26
Accelerator Pedal	27
Brake Pedal	27
Forward / Neutral / Reverse Control	27
Hazard Light Switch	28
Headlight Switch.....	28
Horn.....	28
Key Switch.....	29
Maintenance/Operate Switch.....	29
Park Brake.....	30
Turn Signal Lever	30

SECTION 4 – VEHICLE FEATURES.....	31
--	-----------

Vehicle Features Description	32
Fixed Rear Seat.....	32
Fold-Down Rear Seat.....	32
USB Receptacle.....	32

SECTION 5 – VEHICLE SPECIFICATIONS.....	33
--	-----------

Dimensions	34
Performance.....	34
Tires	34
Gasoline Engine	34
Battery	35
Noise And Vibration	35
Transaxle.....	35

Vehicle Weights And Load Capacities	35
SECTION 6 – VEHICLE OPERATION	37
<hr/>	
Daily Pre-Operational Safety And Performance Checks	39
Overview	39
Daily Pre-Operational Safety Checklist	40
Vehicle Performance Inspection	41
Vehicle Movement.....	42
Overview	42
Engine Start.....	42
Turn Off Engine	43
Forward Movement	43
Reverse Movement.....	43
Slow Or Stop The Vehicle	44
Park The Vehicle	44
Driving Conditions	44
Unpaved Surfaces	44
Uphill Slope.....	44
Side Hill Slope.....	45
Downhill Slope	46
Over Obstacles	46
Below Obstacles	47
Night Time	47
Through Water.....	47
With Cargo.....	48
SECTION 7 – VEHICLE MAINTENANCE	49
<hr/>	
Disable The Vehicle	51
Vehicle Cleaning.....	51
Windshield	51
Vehicle Exterior	51
Vehicle Interior	51
Maintenance Schedule	52
Overview.....	52
Service Schedule.....	52
Maintenance Tasks.....	53
Air Filter	53
Engine Oil.....	54
Refuel.....	59
Lift The Vehicle	60
Lower The Vehicle.....	62
Spark Plug.....	64
Tire Pressure Measurement	65
Wheel Assembly	66
SECTION 8 – BATTERY MAINTENANCE	67
<hr/>	
Battery Cleaning	68
Battery Charging	68
Jump Start With Battery Charger	68
Battery Electrical Connection	69
Disconnect	69
Connect.....	69
SECTION 9 – TRANSPORT AND TOW.....	71
<hr/>	
Prepare The Vehicle To Be Towed.....	72
Towing A Trailer Or Vehicle	72
Tow The Vehicle With Approved Tow Vehicle	72
Vehicle Transport Preparation	73

Vehicle Transport Recovery	73
SECTION 10 – EXTENDED STORAGE	75
Extended Storage Preparation	76
Return To Service From Extended Storage	78
SECTION 11 – WARRANTIES	79
Limited Warranty	80
Warranty	80
Warranty Timeframe	80
Exclusions	80
Voiding Of Warranty	81
Sole Remedy	82
Disclaimer	82
No Consequential Damages	82
How To Make A Warranty Claim	82
Federal Emissions Component Defect Warranty	83
Warranty Coverage	83
Warranty Period	83
Parts Covered	83
Distribution Center	84
Warranty Service	84
What Is Not Covered	84
Owner’s Responsibilities	85
Things To Know About The Emission Control System Warranty Maintenance And Repairs	85
How To Make A Claim	85
California Evaporative Emission Control Warranty Statement	86
Your Warranty Rights And Obligations	86
Manufacturer’s Warranty Coverage	86
Owner’s Warranty Responsibilities	86
Defects Warranty Coverage	86
Evaporative Emissions Warranty Parts List	87

(Page intentionally left blank.)



1

SAFETY INFORMATION

GENERAL SAFETY INFORMATION

This vehicle is designed and intended to transport people on improved or semi-improved surfaces for applications including commercial, industrial, agriculture and personal use, where permitted by law or by regulatory authority rules. Always adhere to local laws and regulations pertaining to the use of the vehicle.

Only operate this vehicle as described in this manual. Speak with your local dealer or distributor for changes, additions, or modifications that are necessary to comply with local laws and regulations pertaining to the use of the vehicle.

Any vehicle can be used in a variety of usages outside of the manufacturer's intent. Club Car cannot anticipate and warn for every possible usage condition. Therefore, the operator must exercise good sense and judgement and must operate the vehicle in an appropriate manner for the way in which the vehicle is being used.

PRACTICE SAFETY

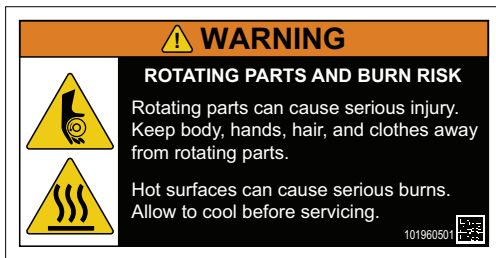

Signal words (DANGER, WARNING, CAUTION, and NOTICE) and safety messages are in this manual and on safety decals. Read, understand, and obey all instructions, safety precautions, and safety decals before vehicle operations.

Replace missing, damaged, or unreadable safety decals immediately to prevent possible property damage, personal injury, or death. Purchase replacement safety decals from your dealer or distributor.

Know and understand all laws and regulations for vehicle operation in your area.

Speak with your dealer or distributor if you have questions about material contained in this manual or the vehicle.





SAFETY SIGNAL WORDS

Signal words (DANGER, WARNING, CAUTION, and NOTICE) and safety messages are in this manual and on safety decals. Read, understand, and obey all instructions, safety precautions, and safety decals before vehicle operations.

Safety messages are necessary and must be obeyed.



The safety alert symbol is used to alert you to possible personal injury hazards. Obey all safety messages that follow this symbol to prevent possible injury or death.

SAFETY SIGNAL WORD	SIGNIFICANCE
	<p>A DANGER identifies a hazardous situation which will result in death or serious injury.</p>
	<p>A WARNING identifies a hazardous situation which could result in death or serious injury.</p>
	<p>A CAUTION identifies a hazardous situation which could result in minor or moderate injury.</p>
	<p>A NOTICE identifies a hazardous situation which could result in property damage.</p>

SAFETY COMMITTEE

If the vehicle is rented or part of a fleet, Club Car recommends a safety committee. The primary concern of the safety committee is safe vehicle operation.

Safety committee objectives include:

- Approve vehicle operation areas.
- Identify all hazards.
- Identify who is approved to operate the vehicle.
- Keep the vehicles in a safe and serviceable condition.
- Supply instructions on safe vehicle operation.
- Visually show all hazards.

VEHICLE SAFETY INFORMATION



FAILURE TO OBEY INSTRUCTIONS IN THIS MANUAL CAN CAUSE PROPERTY DAMAGE, SERIOUS PERSONAL INJURY, OR DEATH. BEFORE YOU OPERATE THE VEHICLE OR DO THE SERVICING OF THE VEHICLE, READ AND FULLY UNDERSTAND THE OWNER'S MANUAL.

CLUB CAR VEHICLES ARE NOT RATED FOR OPERATION IN EXPLOSIVE AREAS. THE VEHICLE OR BATTERY CHARGER CAN CAUSE FLAMMABLE MATERIAL AND FUME IGNITION. DO NOT OPERATE THE VEHICLE OR BATTERY CHARGER NEAR FLAMMABLE MATERIALS AND FUMES.

THE VEHICLE DOES NOT GIVE PROTECTION FROM LIGHTNING, FLYING OBJECTS, OR OTHER STORM RELATED HAZARDS. DO NOT OPERATE THE VEHICLE IN STORMS. STOP THE VEHICLE. GET OUT OF THE VEHICLE IMMEDIATELY AND FIND A SHELTER IN ACCORDANCE WITH APPLICABLE SAFETY GUIDELINES FOR YOUR LOCATION IF IN A STORM.

UNINTENDED VEHICLE OPERATION CAN CAUSE SERIOUS PERSONAL INJURY OR DEATH. MAKE SURE THAT CHILDREN ARE ALWAYS SUPERVISED IN AND AROUND THE VEHICLE.

DO NOT OPERATE THE VEHICLE UNDER THE INFLUENCE OF ALCOHOL, DRUGS, MEDICATIONS, OR WHILE DISTRACTED.

⚠ WARNING

ELECTRICAL SHORTS CAN CAUSE A FIRE, ELECTRICAL SHOCK, SERIOUS PERSONAL INJURY, OR DEATH. PREVENT CONTACT BETWEEN POSITIVE VOLTAGE AND THE GROUND CIRCUIT. USE INSULATED TOOLS.

A HOT ENGINE AND EXHAUST SYSTEM WILL CAUSE SERIOUS BURNS. DO NOT TOUCH A HOT ENGINE OR EXHAUST. BEFORE SERVICING, LET THE ENGINE AND EXHAUST SYSTEM COOL.

TO HELP PREVENT BEING HIT, DO NOT STAND IN FRONT OF OR BEHIND THE VEHICLE.

ONLY TWO PERSONS PER BENCH SEAT. ONLY RIDE ON THE BENCH SEAT. DO NOT LET PEOPLE RIDE ON ANY PART OF THE VEHICLE THAT IS NOT EQUIPPED WITH A SEAT. DO NOT LET A PASSENGER HOLD A CHILD IN HIS OR HER LAP WHILE THE VEHICLE MOVES.

ONLY TRAINED TECHNICIANS SHOULD SERVICE OR REPAIR THE VEHICLE. ANYONE DOING EVEN SIMPLE REPAIRS OR SERVICE SHOULD HAVE KNOWLEDGE AND EXPERIENCE IN ELECTRICAL AND MECHANICAL REPAIR. THE APPROPRIATE INSTRUCTIONS MUST BE USED WHEN PERFORMING MAINTENANCE, SERVICE, OR ACCESSORY INSTALLATION.

⚠ CAUTION

EXTENDED OPERATION OF ELECTRICAL ACCESSORIES WITH OR WITHOUT THE ENGINE ON CAN DISCHARGE THE BATTERY AND CAUSE THE VEHICLE TO TURN OFF. THE OPERATOR AND PASSENGERS CAN BECOME STRANDED. KEEP THE TOTAL DRAW OF ELECTRICAL ACCESSORIES BELOW THE CHARGING SYSTEM CAPACITY RATING.

VEHICLE SAFETY AND COMPLIANCE DECALS

⚠ WARNING

MAKE SURE ALL OF THE SAFETY AND OPERATION DECALS ARE IN THE CORRECT LOCATION ON THE VEHICLE. REPLACE THE SAFETY AND OPERATION DECALS THAT ARE MISSING OR DAMAGED.



Understand and obey all safety decals. The instructions on these safety decals must be followed in order to prevent the risk of dangerous personal injury or property damage.

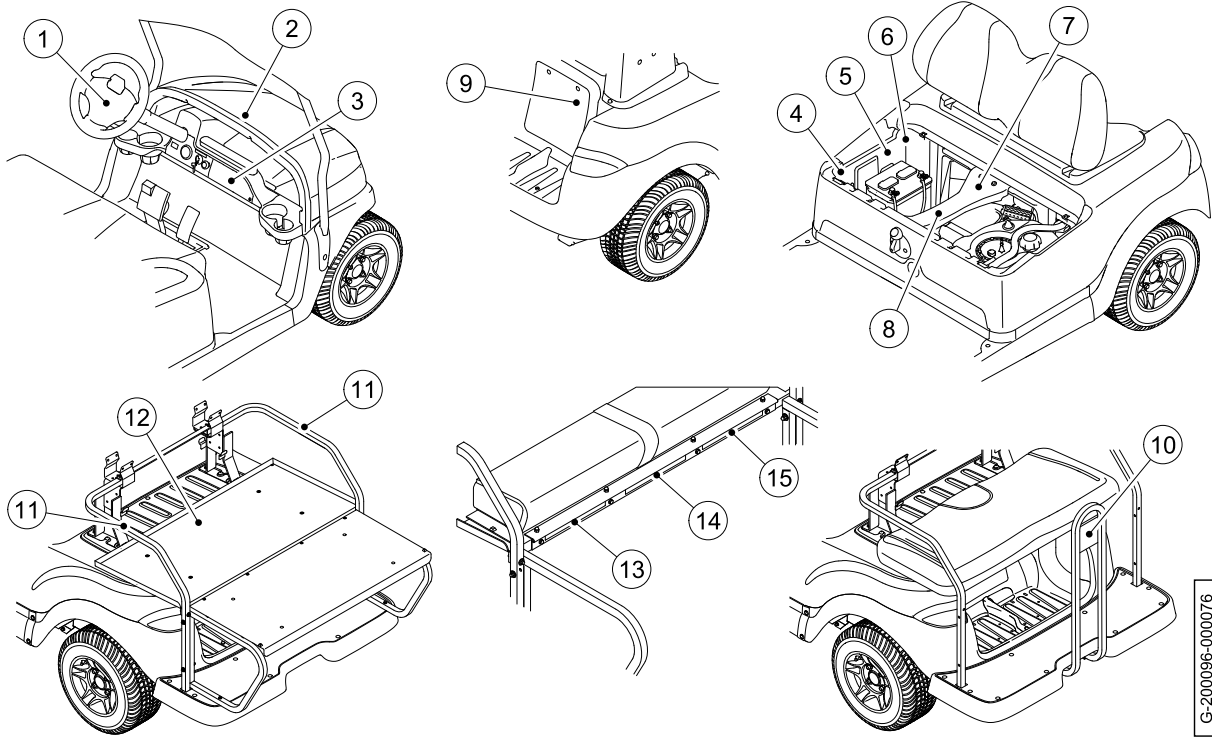

Use a soft moist cloth to clean the decals. Do not use solvents, gasoline, or other chemicals to clean the decals. Do not pressure wash decals.

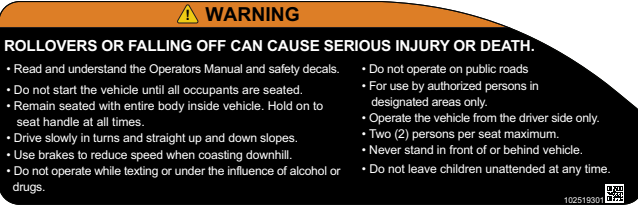
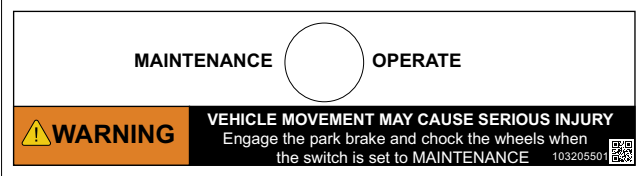

G-200096-000076

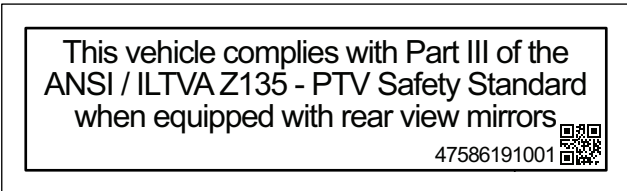
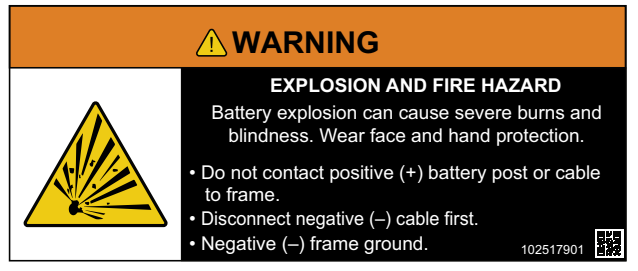
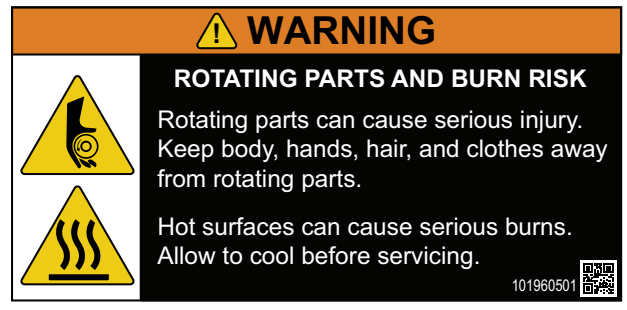
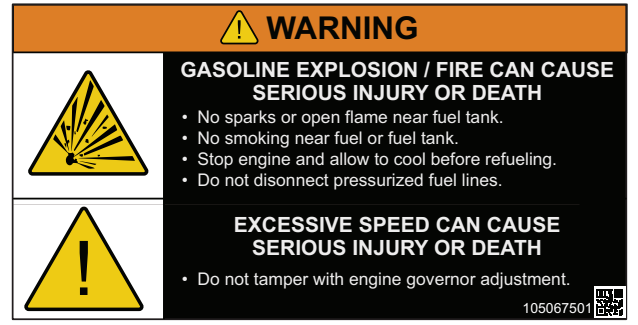
<p style="text-align: center;">OPERATING INSTRUCTIONS</p> <p>Before using vehicle, read owner's manual and vehicle safety warnings. Study and understand controls.</p> <p style="text-align: center;">TO OPERATE</p> <ul style="list-style-type: none"> • Ensure wheels are turned in desired direction of travel and path is clear. • Turn key to ON. • Set the FNR control to FORWARD (F) or REVERSE (R) only when stopped. • Disengage the park brake. • Vehicle will start moving when accelerator pedal is pushed. • Slowly push the accelerator pedal to increase speed. • To stop, release accelerator pedal and push the brake pedal. <p style="text-align: center;">! WARNING</p> <p style="text-align: center;">UNINTENDED VEHICLE MOVEMENT CAN CAUSE SERIOUS INJURY OR DEATH</p> <p>Before leaving vehicle:</p> <ul style="list-style-type: none"> • Engage park brake to lock wheels. • Set the FNR control to NEUTRAL (N). • Turn the key to OFF and remove key. <p style="text-align: center;">103783002 </p>	<p style="text-align: center;">! WARNING</p> <div style="display: flex; align-items: center;"> <div> <p>RISK OF EYE INJURY</p> <p>Windshield does not provide protection from golf balls or other flying objects.</p> <p>47592393001 </p> </div> </div>
<p style="text-align: center;">1. Operating Instructions Decal</p>	<p style="text-align: center;">2. Windshield Warning Decal (Optional)</p>

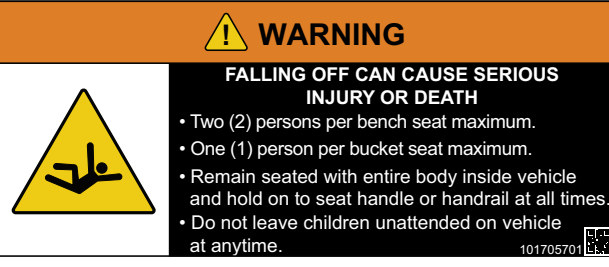
 <p>WARNING ROLLOVERS OR FALLING OFF CAN CAUSE SERIOUS INJURY OR DEATH.</p> <ul style="list-style-type: none"> • Read and understand the Operators Manual and safety decals. • Do not start the vehicle until all occupants are seated. • Remain seated with entire body inside vehicle. Hold on to seat handle at all times. • Drive slowly in turns and straight up and down slopes. • Use brakes to reduce speed when coasting downhill. • Do not operate while texting or under the influence of alcohol or drugs. • Do not operate on public roads • For use by authorized persons in designated areas only. • Operate the vehicle from the driver side only. • Two (2) persons per seat maximum. • Never stand in front of or behind vehicle. • Do not leave children unattended at any time. <p>10251F501</p>	 <p>MAINTENANCE  OPERATE</p> <p>WARNING VEHICLE MOVEMENT MAY CAUSE SERIOUS INJURY Engage the park brake and chock the wheels when the switch is set to MAINTENANCE</p> <p>103205501</p>
<p>3. Rollover Warning Decal</p>	<p>4. Maintenance Operate Switch Decal</p>
 <p>This vehicle complies with Part III of the ANSI / ILTVA Z135 - PTV Safety Standard when equipped with rear view mirrors</p> <p>47586191001</p>	 <p>WARNING EXPLOSION AND FIRE HAZARD Battery explosion can cause severe burns and blindness. Wear face and hand protection.</p> <ul style="list-style-type: none"> • Do not contact positive (+) battery post or cable to frame. • Disconnect negative (-) cable first. • Negative (-) frame ground. <p>102517901</p>
<p>5. Vehicle Compliance Decal (Optional with PTV kit)</p>	<p>6. Frame Ground Warning Decal</p>
 <p>WARNING ROTATING PARTS AND BURN RISK Rotating parts can cause serious injury. Keep body, hands, hair, and clothes away from rotating parts. Hot surfaces can cause serious burns. Allow to cool before servicing.</p> <p>101960501</p>	 <p>WARNING GASOLINE EXPLOSION / FIRE CAN CAUSE SERIOUS INJURY OR DEATH</p> <ul style="list-style-type: none"> • No sparks or open flame near fuel tank. • No smoking near fuel or fuel tank. • Stop engine and allow to cool before refueling. • Do not disconnect pressurized fuel lines. <p>EXCESSIVE SPEED CAN CAUSE SERIOUS INJURY OR DEATH</p> <ul style="list-style-type: none"> • Do not tamper with engine governor adjustment. <p>105067501</p>
<p>7. Rotating Parts / Hot Manifold Warning Decal</p>	<p>8. Gas / Governor Warning Decal</p>

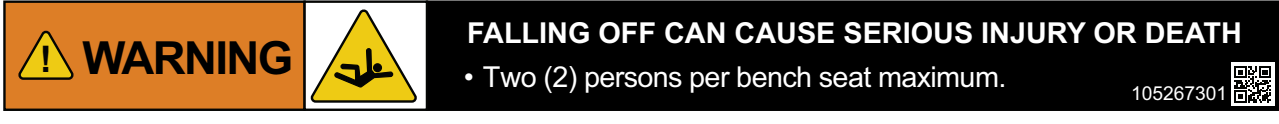
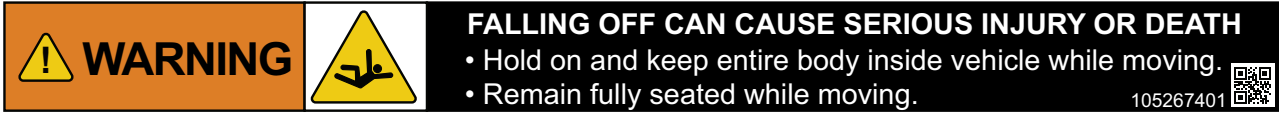
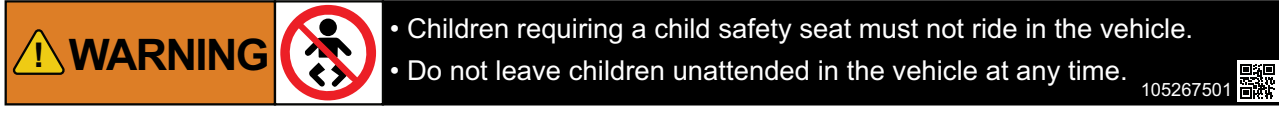
	
<p>9. Rotating Parts / Hot Manifold Warning Decal</p>	<p>10. Falling Off Warning Decal (Fixed Rear Seat)</p>
	
<p>11. Crush Area Warning Decal (Fold-Down Rear Seat)</p>	<p>12. Cargo Bed Warning Decal (Fold-Down Rear Seat)</p>
	
<p>13. Falling Out Warning Decal (Fold-Down Rear Seat)</p>	
	
<p>14. Hold On Warning Decal (Fold-Down Rear Seat)</p>	
	
<p>15. Children Unattended Warning Decal (Fold-Down Rear Seat)</p>	

VEHICLE SAFETY FEATURES

MULTI-PURPOSE BUZZER

The vehicle comes equipped with a multi-purpose buzzer. The multi-purpose buzzer makes an audible tone when the Forward / Neutral / Reverse control (FNR) is set to R.

BATTERY SAFETY INFORMATION

**DANGER**

BATTERY ACID CAN CAUSE SERIOUS BURNS. PREVENT CONTACT WITH SKIN, EYES, AND CLOTHING. WEAR A FULL FACE SHIELD AND RUBBER GLOVES WHEN SERVICING A BATTERY. ANTIDOTES: EXTERNAL: FLUSH WITH WATER. CALL A PHYSICIAN IMMEDIATELY. INTERNAL: DRINK LARGE QUANTITIES OF MILK OR WATER FOLLOWED WITH MILK OF MAGNESIA OR VEGETABLE OIL. CALL A PHYSICIAN IMMEDIATELY. EYES: FLUSH WITH WATER FOR 15 MINUTES. CALL A PHYSICIAN IMMEDIATELY.

**WARNING**

FROZEN BATTERY ACID CAN CAUSE DAMAGE INCLUDING LEAKS AND EXPLOSIONS. IF THE BATTERY ACID FREEZES, REPLACE THE BATTERY BEFORE CHARGING OR USE. BATTERIES IN A LOW STATE OF CHARGE WILL FREEZE AT LOW TEMPERATURES. KEEP THE BATTERIES IN A HIGH STATE OF CHARGE.





FLOODED AND SUBMERGED BATTERIES CAN CAUSE DAMAGE INCLUDING LEAKS AND EXPLOSION. IF A BATTERY IS SUBMERGED, REPLACE THE BATTERY BEFORE CHARGING OR USE.

LOOSE BATTERY WIRES CAN CAUSE A FIRE, PROPERTY DAMAGE, OR SERIOUS PERSONAL INJURY. MAKE SURE THAT ALL BATTERY WIRES AND TERMINALS ARE CLEAN AND TIGHTENED CORRECTLY.

BATTERY WIRES WITH DAMAGE OR CORROSION CAN BECOME TOO HOT AND CAUSE A FIRE, PROPERTY DAMAGE, OR SERIOUS PERSONAL INJURY. REPLACE BATTERY WIRES THAT HAVE DAMAGE OR CORROSION. CLEAN CORROSION FROM THE BATTERY TERMINALS.

BATTERY INTERNATIONAL SAFETY SYMBOLS

Understand and obey the international safety symbols on the vehicle battery before you use, repair, or service the vehicle.

SYMBOL	SIGNIFICANCE
	Shield eyes
	Read and obey operation and maintenance instructions
	Do not smoke, No open flames, No sparks
	Keep away from children
	Explosive gas hazard

LEAD-ACID BATTERY RECYCLING



LEAD-ACID BATTERIES CONTAIN DANGEROUS MATERIALS THAT CAN CONTAMINATE THE WATER AND SOIL, CAUSE ENVIRONMENTAL DAMAGE, CAUSE PROPERTY DAMAGE, AND CAUSE SERIOUS PERSONAL INJURY. SPEAK WITH YOUR DEALER OR DISTRIBUTOR FOR INFORMATION ON HOW TO DISCARD A BATTERY CORRECTLY.

Lead-acid batteries and other components which have the Waste Electrical and Electronic Equipment (WEEE) symbol printed on them must be collected and recycled separately from other waste. Do not discard lead-acid batteries as municipal waste.

Speak with your dealer or distributor on how to correctly recycle lead-acid batteries.

(Page intentionally left blank.)

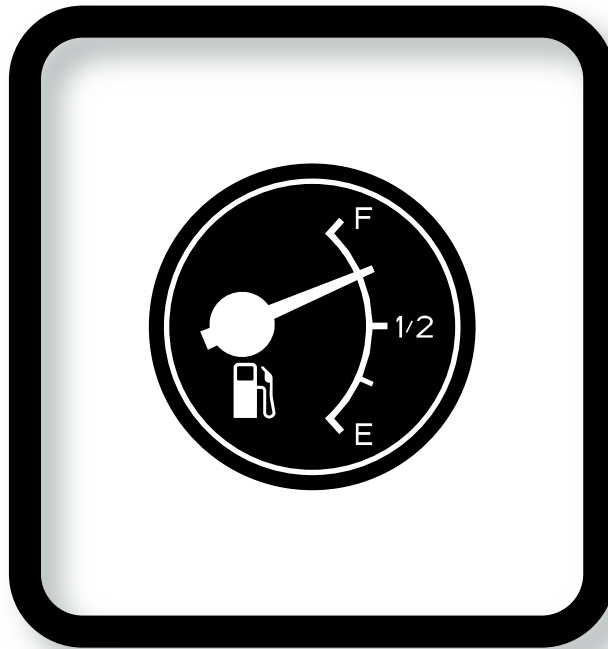

2

INDICATORS, GAUGES, AND DISPLAYS

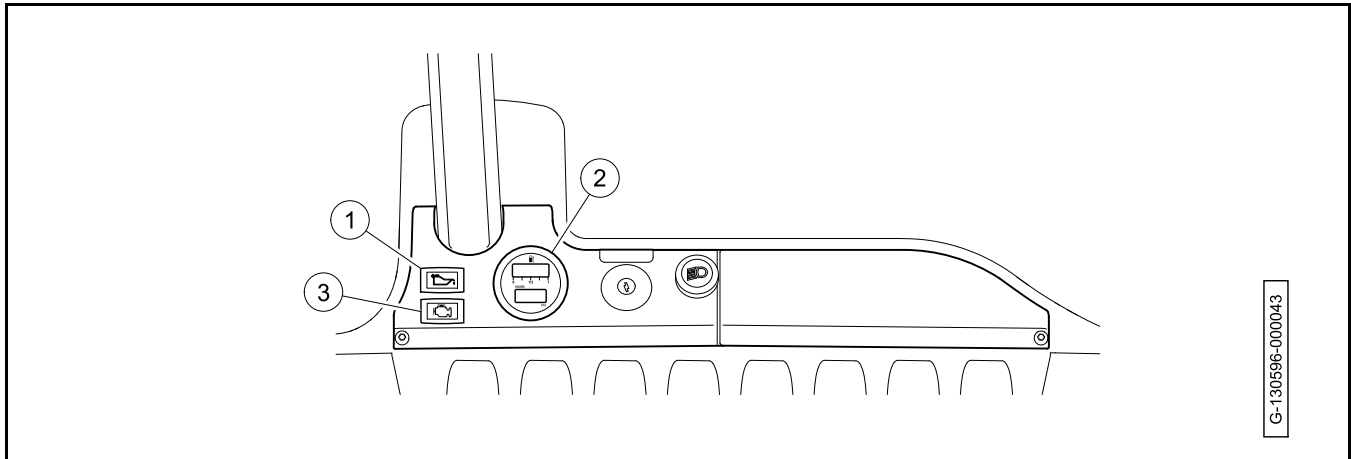
INDICATOR, GAUGE, AND DISPLAY LOCATIONS

G-130596-00043

1. Low Oil Warning Light

2. Fuel Gauge/Hour Meter

3. Malfunction Indicator Light (MIL)

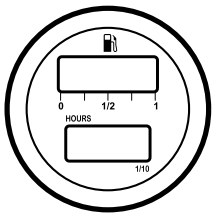
FUEL GAUGE/HOUR METER

The fuel gauge/hour meter gives a visual indication of:

- Fuel level
- Total engine run time

The fuel gauge operates when the key switch is set to ON.

The hour meter operates when the engine is on. The hour meter should be used by approved technicians to monitor vehicle use as well as determine when periodic inspections and maintenance are necessary.

LOW OIL WARNING LIGHT**NOTICE**

FAILURE TO ADD OIL IMMEDIATELY WHEN THE LOW OIL WARNING LIGHT STAYS ON CAN CAUSE PERMANENT ENGINE DAMAGE. ADD ENGINE OIL IMMEDIATELY WHEN THE LOW OIL WARNING LIGHT STAYS ON.

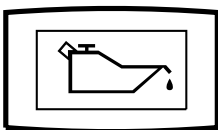

The low oil warning light gives a visual indication of an oil level problem.

STATUS	CONDITION
OFF	Normal Operation
ON	When possible: <ol style="list-style-type: none"> 1. Stop the vehicle. 2. Turn the key to OFF. 3. Examine the engine oil level. 4. Add engine oil as necessary. 5. If the low oil level warning light stays on, have a trained technician examine the vehicle.

MALFUNCTION INDICATOR LIGHT

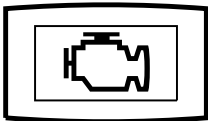

The Malfunction Indicator Light (MIL) gives a visual indication of an engine fault code.

STATUS	CONDITION
OFF	Normal Operation
ON (THREE SECONDS)	Normal operation when the key switch is set to ON.
ON	There is an engine fault code. Speak with your local dealer or distributor.

(Page intentionally left blank.)



3

VEHICLE CONTROLS

VEHICLE CONTROLS LOCATOR

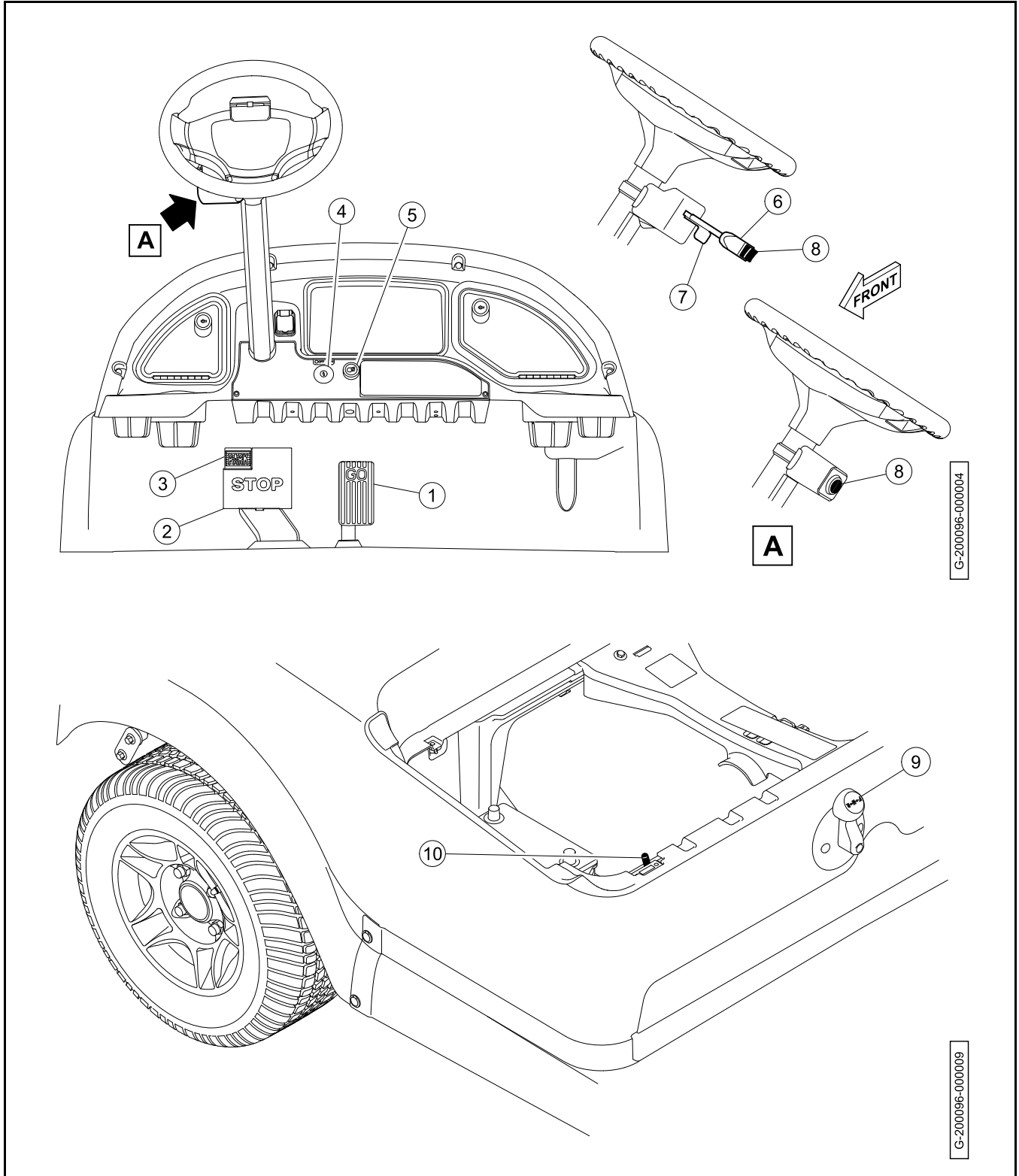

G-200096-000004

G-200096-000009

1. Accelerator Pedal	2. Brake Pedal
3. Park Brake	4. Key Switch
5. Headlight Switch	6. Turn Signal Lever (Optional Equipment)
7. Hazard Lights Switch (Optional Equipment)	8. Horn Button (Optional Equipment)
9. Forward / Neutral / Reverse Control (FNR)	10. Maintenance/Operate Switch

ACCELERATOR PEDAL

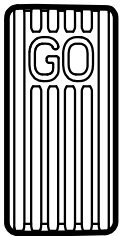

The accelerator pedal controls the operation of the engine (start or stop). The accelerator pedal is used to increase and maintain the speed of the vehicle.

BRAKE PEDAL

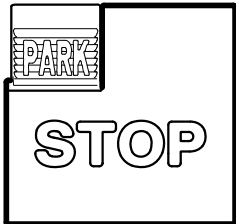

The brake pedal is used to decrease speed or stop the vehicle.

FORWARD / NEUTRAL / REVERSE CONTROL



FAILURE TO STOP THE VEHICLE BEFORE SHIFTING THE FORWARD / NEUTRAL / REVERSE CONTROL (FNR) CAN CAUSE PROPERTY DAMAGE AND SERIOUS PERSONAL INJURY. STOP THE VEHICLE BEFORE SHIFTING THE FORWARD / NEUTRAL / REVERSE CONTROL (FNR).

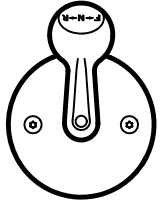

The Forward / Neutral / Reverse control (FNR) sets the direction of vehicle movement.

Stop the vehicle to change the FNR position.

The engine will not operate when the FNR is set to N.

POSITION	FUNCTION
F	Forward
N (Center)	Neutral
R	Reverse

HAZARD LIGHT SWITCH

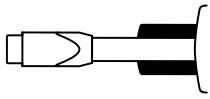

The hazard light switch controls the operation of the hazard lights. Move the turn signal switch up or down to turn off the hazard lights.

POSITION	FUNCTION
Out	On
In	Off

HEADLIGHT SWITCH



The headlight switch controls the operation of the headlights.

POSITION	FUNCTION
Out	On
In	Off

HORN

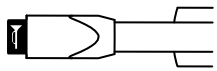

The horn button is used to control the horn. The horn button is spring loaded to stay in the off position. Push and hold the horn button to operate the horn.



KEY SWITCH

WARNING

THE KEY SWITCH CAN BE USED TO DISABLE THE ENGINE IN AN EMERGENCY. DO NOT BREAK OFF KEYS IN THE KEY SWITCH.

OFF | ON

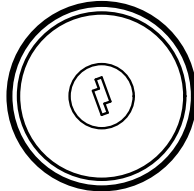

The key switch controls the engine and electrical system. A key is used to select the key switch position. The key can only be inserted or removed when the key switch is set to OFF. Vehicles with this key switch are pedal-start vehicles.

POSITION	CONDITION
OFF	Normal position when the vehicle is not in use. Electrical power from the battery is not available to power the engine, engine starter, or electrical systems. <i>Note:</i> Some electrical accessories operate independently of the key switch.
ON	Normal position when the vehicle is in use. Electrical power from the battery is available to power the engine, engine starter, and electrical systems.

MAINTENANCE/OPERATE SWITCH

WARNING

WITH THE SWITCH SET TO MAINTENANCE AND THE ENGINE ON, THE VEHICLE CAN MOVE SUDDENLY IF THE FORWARD / NEUTRAL / REVERSE CONTROL (FNR) IS ACCIDENTALLY SHIFTED. ENGAGE THE PARK BRAKE. PUT CHOCKS AGAINST THE FRONT AND REAR WHEELS.



The maintenance/operate switch is used by a trained technician to do maintenance functions with the engine on.

POSITION	CONDITION
OPERATE	Normal Operation
MAINTENANCE	Only to be used for extended storage and by a trained technician for maintenance functions.

PARK BRAKE

WARNING

FAILURE TO ENGAGE THE PARK BRAKE CAN CAUSE PROPERTY DAMAGE AND SERIOUS PERSONAL INJURY. AFTER THE VEHICLE STOPS, ENGAGE THE PARK BRAKE UNTIL IT IS FULLY ENGAGED AND PREVENTS THE VEHICLE FROM MOVING.

UNINTENDED VEHICLE OPERATION CAN CAUSE SERIOUS PERSONAL INJURY OR DEATH. THE PARK BRAKE WILL RELEASE AUTOMATICALLY WHEN THE ACCELERATOR OR BRAKE PEDAL IS PUSHED. PREVENT ACCIDENTAL ACCELERATOR OR BRAKE PEDAL ACTUATION.



The park brake is a variable position control that is used to make sure that a vehicle does not move while parked.

Push the park brake firmly to engage the park brake.

To disengage the park brake, push the accelerator or brake pedal.

TURN SIGNAL LEVER



The turn signal lever controls the operation of the turn signal lights. The turn signal light will flash when turned on.

POSITION	FUNCTION
Down	Left
Center	Off
Up	Right

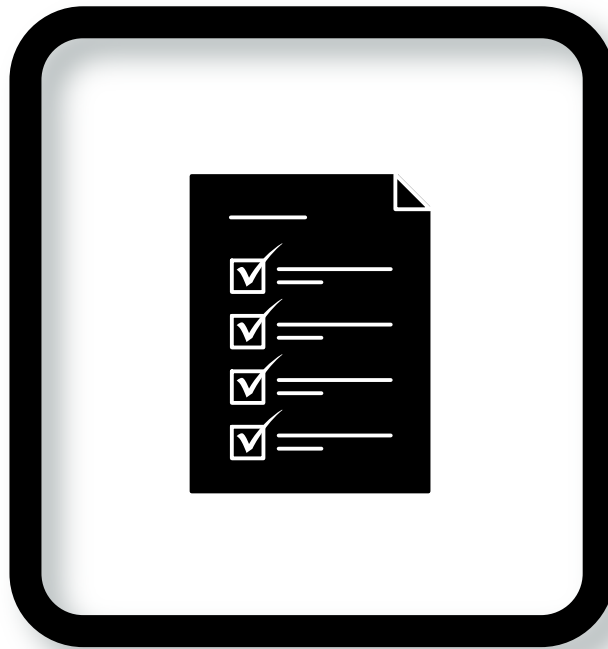

4

VEHICLE FEATURES

The vehicle features listed are standard and optional.

FIXED REAR SEAT

The fixed rear seat is for two additional passengers.

FOLD-DOWN REAR SEAT

The fold-down rear seat is for two additional passengers and increased cargo space.

USB RECEPTACLE

The 5-volt, 2.1-amp USB receptacle supplies electricity to power and charge portable devices. The USB receptacle is not for the movement of data.

The USB receptacle will only operate when a shielded USB cord is connected. When the USB receptacle is not in use, remove the shielded USB cord to prevent battery discharge.

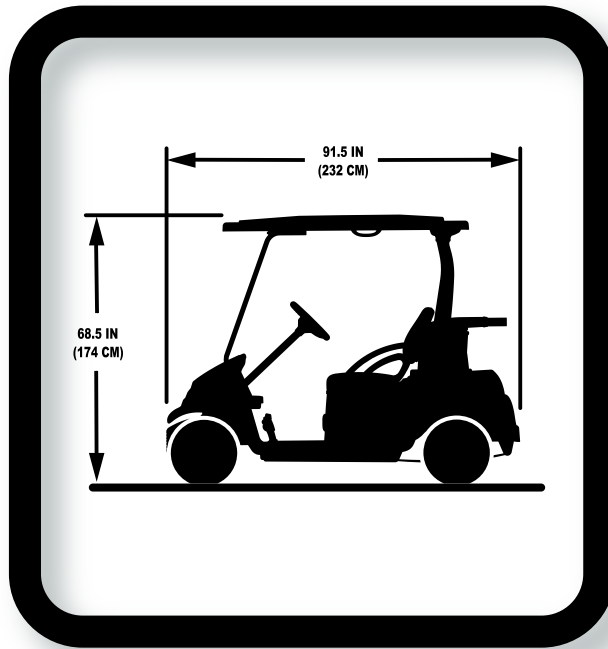

5

VEHICLE SPECIFICATIONS

DIMENSIONS

Length	104 in (264 cm)
Width	47.25 in (120 cm)
Height	48.0 in (122 cm) - at steering wheel 71 in (180 cm) - with canopy
Ground Clearance	4.5 in (11 cm)
Wheel Tread	34.5 in (88 cm) - front wheel 38.6 in (98 cm) - rear wheel
Wheel Base	65.5 in (166 cm)

PERFORMANCE

Forward Speed (On Level Ground)	19 mph (30 km/h) - maximum
Turning Radius (SAE J695)	Unknown At Time Of Print
Intersecting Aisle Clearance	Unknown At Time Of Print
Curb-To-Curb	Unknown At Time Of Print
Wall-To-Wall	Unknown At Time Of Print
Outside Clearance Circle (Diameter)	17 ft, 4 in (528 cm)

TIRES

Go to the approved wheel and tire assemblies matrix on <http://www.clubcar.com> for information regarding tire type, inflation pressure, and lugnut torque.

GASOLINE ENGINE

Horsepower Rating	14 hp (10.4 kW) at 3600 rpm (per SAE J1940)
Fuel Type	Gasoline with less than 10% ethanol rating
Fuel Capacity	5.6 gal (21.2 l)
Engine Oil Capacity	39 fl-oz (1.1 l)

BATTERY

Battery Type	12V no-maintenance
Battery Quantity	1

NOISE AND VIBRATION

Drive-by Noise Level To Operator (EN 12053–2001)	83.8 dBA (±2)
Vibration At Driver’s Seat (EN 13059–2002)	0.8 (m/s ²) ² (±0.23)

TRANSAXLE

Fluid Capacity	67.6 fl-oz (2 l)
----------------	------------------

VEHICLE WEIGHTS AND LOAD CAPACITIES

⚠ WARNING

IF THE RATED CAPACITIES OF THE VEHICLE ARE EXCEEDED, PROPERTY DAMAGE, SERIOUS PERSONAL INJURY, OR DEATH CAN OCCUR. DO NOT EXCEED THE RATED CAPACITY OF THE VEHICLE. RATED CAPACITY IS FOR LEVEL SURFACES ONLY.

TOO MUCH WEIGHT IN THE VEHICLE CAN AFFECT THE VEHICLES HANDLING, OR CAUSE COMPONENT FAILURE, RESULTING IN LOSS OF CONTROL OF VEHICLE AND SERIOUS PERSONAL INJURY. DO NOT EXCEED THE VEHICLE LOAD CAPACITIES.

DO NOT TOW WHEN THE CARGO CAPACITY IS EXCEEDED.

Description	Weight
Vehicle Dry Weight	768 lb (348 kg)
Vehicle Curb Weight	805 lb (365 kg)
Maximum Occupant Capacity	800 lb (363 kg)
Maximum Cargo Capacity	Not Applicable
Maximum Trailer Tongue Weight	Not Applicable
Maximum Gross Trailer Weight	Not Applicable

Description	Weight
Vehicle Rated Capacity	Not Applicable
Vehicle Combination Rated Capacity	Not Applicable
Maximum Gross Vehicle Weight	1605 lb (728 kg)
Maximum Gross Vehicle Combination Weight	Not Applicable

TERM	DEFINITION
Vehicle Dry Weight	The vehicle dry weight is the weight of the vehicle with no fuel.
Vehicle Curb Weight	The vehicle curb weight is the weight of the vehicle with the fuel tank filled.
Maximum Occupant Capacity	The occupant capacity is the maximum permitted weight of occupants to operate the vehicle safely.
Maximum Cargo Capacity	The cargo capacity is the maximum weight of a load that the vehicle can have in the cargo area. The cargo capacity includes the weight of optional equipment.
Maximum Trailer Tongue Weight	The trailer tongue weight is the maximum permitted weight applied by the trailer tongue onto the trailer hitch.
Maximum Gross Trailer Weight	The gross trailer weight is the trailer weight plus the weight of the load on the trailer.
Vehicle Rated Capacity	The vehicle rated capacity is the maximum weight on the vehicle. This capacity includes the weight of: bed load, cargo, occupants, and optional equipment.
Vehicle Combination Rated Capacity	The vehicle combination rated capacity is the maximum weight on the vehicle with a trailer. This capacity includes: vehicle rated capacity and the gross trailer weight.
Maximum Gross Vehicle Weight	The maximum gross vehicle weight is the vehicle weight plus the vehicle rated capacity.
Maximum Gross Vehicle Combination Weight	The maximum gross vehicle combination weight is the maximum gross vehicle weight plus the gross trailer weight.



6

VEHICLE OPERATION

WARNING

FALLING OBJECTS CAN CAUSE PROPERTY DAMAGE, SERIOUS PERSONAL INJURY, OR DEATH. DO NOT OPERATE THE VEHICLE WHERE THERE IS A RISK OF FALLING OBJECTS.

OPERATING THE VEHICLE WHILE OCCUPANTS ARE NOT FULLY SEATED CAN CAUSE SERIOUS PERSONAL INJURY OR DEATH. START THE VEHICLE ONLY WHEN ALL OCCUPANTS ARE FULLY SEATED.

DO NOT LET A PASSENGER HOLD A CHILD ON THEIR LAP WHILE THE VEHICLE IS IN OPERATION.

DO NOT LET PASSENGERS RIDE IN THE VEHICLE OR TRAILER BEING TOWED.

KEEP AWAY FROM DROP-OFFS, STEEP SLOPES, AND UNSTABLE SURFACES.

THE VEHICLE IS NOT INTENDED TO BE USED ON PUBLIC ROADS. USE CAUTION WHEN OPERATING ON PUBLIC ROADS WHERE PERMITTED BY LAW. FOLLOW ALL APPLICABLE LAWS AND REGULATIONS.

SUDDEN STARTS, STOPS, AND TURNS CAN CAUSE PROPERTY DAMAGE AND SERIOUS PERSONAL INJURY. PREVENT SUDDEN STARTS, STOPS, AND TURNS.

FAILURE TO CORRECTLY MAINTAIN THE VEHICLE AND MAKE NECESSARY REPAIRS CAN DECREASE VEHICLE PERFORMANCE, CAUSE A FIRE, PROPERTY DAMAGE, SERIOUS PERSONAL INJURY, OR DEATH. IF PROBLEMS ARE FOUND DURING SCHEDULED INSPECTION OR SERVICE, OPERATE THE VEHICLE ONLY WHEN REPAIRS ARE MADE.

MAKE SURE THAT ALL PASSENGERS CAN SECURE THEMSELVES IN THE VEHICLE BEFORE VEHICLE OPERATION.

TO PREVENT SERIOUS PERSONAL INJURY, KEEP ENTIRE BODY IN THE VEHICLE DURING OPERATION.

THE VEHICLE IS NOT SPECIALLY EQUIPPED FOR HANDICAPPED PERSONS. BEFORE VEHICLE OPERATION, MAKE SURE THAT ALL PERSONS COMPLY WITH THE WARNINGS AND OPERATING INSTRUCTIONS.

INCORRECT OPERATION OF THE VEHICLE CAN CAUSE DECREASED VEHICLE PERFORMANCE, PROPERTY DAMAGE, SERIOUS PERSONAL INJURY, OR DEATH.

TO PREVENT FALLS FROM THE VEHICLE, PASSENGERS MUST STAY SEATED AND ALWAYS HOLD ON TO HAND HOLDS OR HANDRAILS WHEN THE VEHICLE IS IN OPERATION. THE DRIVER MUST KEEP BOTH HANDS ON THE STEERING WHEEL WHEN THE VEHICLE IS IN OPERATION.

A SHARP TURN AT HIGH SPEEDS CAN CAUSE A ROLL-OVER OR FALLING OFF WHICH CAN RESULT IN PROPERTY DAMAGE, AND SERIOUS PERSONAL INJURY. OPERATE THE VEHICLE SLOWLY IN TURNS.

UNINTENDED VEHICLE OPERATION CAN CAUSE SERIOUS PERSONAL INJURY OR DEATH. BEFORE LEAVING THE VEHICLE OR DURING VEHICLE MAINTENANCE, DISABLE THE VEHICLE.

THE VEHICLE IS NOT DESIGNED TO MEET CHILD SAFETY SEAT COMPATIBILITY REQUIREMENTS. CHILDREN REQUIRING A CHILD SAFETY SEAT MUST NOT RIDE ON THE VEHICLE. COMPLY WITH STATE AND LOCAL LAWS PERTAINING TO CHILD SAFETY.

THIS VEHICLE IS NOT INTENDED FOR USE BY PERSONS, INCLUDING CHILDREN, WITH REDUCED PHYSICAL, SENSORY OR MENTAL CAPABILITIES, OR LACK OF EXPERIENCE AND KNOWLEDGE, UNLESS THEY HAVE BEEN GIVEN SUPERVISION OR INSTRUCTION CONCERNING USE OF THE VEHICLE BY A PERSON RESPONSIBLE FOR THEIR SAFETY. CHILDREN SHOULD BE SUPERVISED TO ENSURE THAT THEY DO NOT PLAY WITH THE VEHICLE.

 **CAUTION**

OPERATE THE VEHICLE ONLY FROM THE DRIVERS SEAT.

OPERATE THE VEHICLE ONLY IN SPECIFIED AREAS.

ONLY AN AUTHORIZED LICENSED DRIVER CAN OPERATE THE VEHICLE.

ONLY OPERATE THE VEHICLE IN COMPLIANCE WITH LOCAL AND STATE LAWS.

USE CAUTION WHEN OPERATING THE VEHICLE IN THE PRESENCE OF HIGHER-SPEED VEHICLES, IN CONGESTED AREAS, OR ON UNIMPROVED SURFACES.

DAILY PRE-OPERATIONAL SAFETY AND PERFORMANCE CHECKS

OVERVIEW

Use the daily pre-operational checklist and vehicle performance inspection to inspect the operational condition and performance of the vehicle.

If a vehicle is found to be in bad operational condition, remove it from operation. Removal from operation will prevent more damage to the vehicle and prevent a serious injury.

If the vehicle is removed from operation, speak with your dealer or distributor for maintenance and repairs.

DAILY PRE-OPERATIONAL SAFETY CHECKLIST

INSPECTION AREA	INSPECTION CRITERIA
General	<ul style="list-style-type: none"> • Make sure that all parts are correctly installed. • Make sure that all nuts, bolts, and screws are tight. • Replace missing, worn, or damaged items.
Decals	<ul style="list-style-type: none"> • Make sure all safety, regulatory, and marketing decals are correctly installed. • Clean the decals with a soft moist cloth. • Replace missing, worn, or damaged decals.
Tires	<ul style="list-style-type: none"> • Examine for wear and damage. • Replace worn or damaged tires. • Make sure that the tire pressure is correct.
Battery	<ul style="list-style-type: none"> • Make sure that all battery hold-downs are tight. • Make sure that the battery cables are correctly attached. Tighten as necessary. • Examine the battery posts for corrosion. If corrosion is found, remove the corrosion.
Engine Oil	<ul style="list-style-type: none"> • Examine the oil level. Add oil as necessary.
Engine and Muffler	<ul style="list-style-type: none"> • Make sure that the engine and exhaust system areas are free of debris. Use a brush or compressed air to remove any debris.
Engine Fuel	<ul style="list-style-type: none"> • Examine the fuel system for leakage. • Examine the fuel level. Add fuel as necessary. • Replace missing, worn, or damaged items.
Engine Air Filter	<ul style="list-style-type: none"> • Examine the air filter. Replace if dirty or damaged.
Malfunction Indicator Light (MIL)	<ul style="list-style-type: none"> • When the key switch is set to ON, the MIL will turn on for 3 seconds. If the MIL stays on, speak with your local dealer or distributor.
Vehicle Performance Inspection	<ul style="list-style-type: none"> • Do a vehicle performance inspection.

VEHICLE PERFORMANCE INSPECTION

Before the vehicle performance inspection:

- Read and obey all safety decals and information located on the vehicle.
- Understand how to operate the vehicle correctly and safely.
- Understand the function of all vehicle controls, indicators, displays, and gauges.
- Front wheels are turned in the direction of travel.
- No obstructions are in the vehicle's path.

During the vehicle performance inspection:

- Listen for unusual noises such as squeaks or rattles.
- Examine the ride and performance of the vehicle.
- Examine the steering. The vehicle must be easy to steer and must not have play in the steering wheel.
- The vehicle must stop smooth and straight. The brake pedal must not be able to be pushed to the floorboard. Have a trained technician do a brake system check if:
 - The vehicle swerves.
 - The brake pedal goes more than half the distance to the floorboard with moderate pressure applied.
 - The vehicle does not stop.

To do the vehicle performance inspection:

1. Start the engine.
2. Push and hold the brake pedal.
3. Set the Forward / Neutral / Reverse control (FNR) to R. Make sure that the multi-purpose buzzer operates.
4. Release the brake pedal.
5. Slowly push the accelerator pedal. Make sure the vehicle moves in reverse.
6. Slowly push the brake pedal. Stop the vehicle.
7. Set the FNR to F. Make sure that the multi-purpose buzzer does not operate.
8. Release the brake pedal.
9. Slowly push the accelerator pedal. Make sure that the vehicle moves forward.
10. Operate the vehicle to full speed.
11. Release the accelerator pedal. Make sure:
 - 11.A The accelerator pedal goes back to its initial position.
 - 11.B The engine stops.
12. Slowly push the brake pedal. Stop the vehicle.
13. Release the brake pedal.

14. Slowly push the accelerator pedal. Operate the vehicle to its maximum speed. Adjust the governor as necessary to keep the vehicle at or below the maximum speed limit.
15. Slowly push the brake pedal. Stop the vehicle.
16. Park the vehicle on a grade of 20% or less. Make sure that the park brake holds the vehicles position.

VEHICLE MOVEMENT

OVERVIEW

Operate the vehicle only after you read, understand, and know:

- The Driving Instructions
- Indicators
- Gauges
- Displays
- Controls

ENGINE START

DANGER

THE ENGINE PRODUCES THE DEADLY POISON CARBON MONOXIDE. DO NOT OPERATE THE ENGINE IN AN ENCLOSED AREA WITHOUT CORRECT VENTILATION.

WARNING

MOVING PARTS CAN CRUSH AND CUT. KEEP CLEAR OF THE ENGINE COMPARTMENT WHILE THE ENGINE IS ON.

NOTICE

TRYING TO START THE VEHICLE AGAIN AND AGAIN WITH AN EMPTY FUEL TANK WILL CAUSE FUEL PUMP DAMAGE. DO NOT TRY TO START A VEHICLE WHEN THE FUEL TANK IS EMPTY. MAKE SURE THAT THERE IS FUEL IN THE FUEL TANK BEFORE VEHICLE OPERATION.

Before engine start:

- Read and obey all safety decals and information located on the vehicle.
- Understand how to operate the vehicle correctly and safely.
- Understand the function of all vehicle controls, indicators, displays, and gauges.
- Front wheels are turned in the direction of travel.
- No obstructions are in the vehicle's path.
- Forward / Neutral / Reverse control (FNR) is set to N.
- The park brake is set.
- The accelerator pedal is not pushed.
- The vehicle is at a full stop.

To start the engine:

1. Put the key into the key switch.
2. Turn the key to ON.
3. Push the accelerator pedal to start the engine.

TURN OFF ENGINE

1. Release the accelerator pedal.
2. Stop the vehicle.
3. Engage the park brake to lock the wheels.
4. Set the Forward / Neutral / Reverse control (FNR) to N.
5. Turn the key to OFF.
6. Remove the key. Keep the key in a safe area.

FORWARD MOVEMENT



FAILURE TO DECREASE THE VEHICLE SPEED IN BAD DRIVING CONDITIONS CAN CAUSE PROPERTY DAMAGE, SERIOUS PERSONAL INJURY, OR DEATH. DECREASE THE VEHICLE SPEED WHEN IN BAD DRIVING CONDITIONS SUCH AS WET GRASS OR ROUGH TERRAIN.

Before forward movement:

- Read and obey all safety decals and information located on the vehicle.
- Understand how to operate the vehicle correctly and safely.
- Understand the function of all vehicle controls, indicators, displays, and gauges.
- Make sure that all passengers are seated with seat belts fastened (if equipped) and use the hand holds or handrails. The operator must have both hands on the steering wheel.
- Make sure that the front wheels are turned in the direction of travel.
- Make sure that there are no obstructions in the vehicles path.
- The key switch is set to ON.
- The vehicle is at a full stop.

To move the vehicle forward:

1. Set the Forward / Neutral / Reverse control (FNR) to F.
2. Disengage the park brake.
3. Slowly push the accelerator pedal.

REVERSE MOVEMENT



FAILURE TO DECREASE THE VEHICLE SPEED WHEN IN REVERSE CAN CAUSE PROPERTY DAMAGE, SERIOUS PERSONAL INJURY, OR DEATH. DECREASE THE VEHICLE SPEED WHEN IN REVERSE AND PREVENT SUDDEN STOPS.

Before reverse movement:

- Read and obey all safety decals and information located on the vehicle.
- Understand how to operate the vehicle correctly and safely.
- Understand the function of all vehicle controls, indicators, displays, and gauges.
- Make sure that all passengers are seated with seat belts fastened (if equipped) and use the hand holds or handrails. The operator must have both hands on the steering wheel.
- Make sure that the front wheels are turned in the direction of travel.
- Make sure that there are no obstructions are in the vehicles path.
- The key switch is set to ON.
- The vehicle is at a full stop.

To move the vehicle in reverse:

1. Set the Forward / Neutral / Reverse control (FNR) to R. Make sure that the multi-purpose buzzer operates.
2. Disengage the park brake.
3. Slowly push the accelerator pedal.

SLOW OR STOP THE VEHICLE

1. Release the accelerator pedal.
2. Push the brake pedal.

PARK THE VEHICLE

1. Stop the vehicle.
2. Engage the park brake to prevent vehicle movement.
3. Set the Forward / Neutral / Reverse control (FNR) to N.
4. Turn the key to OFF.
5. Remove the key. Keep the key in a safe area.

DRIVING CONDITIONS

UNPAVED SURFACES

Precautions for operation on unpaved or unimproved surfaces:

- Decrease vehicle speed.
- Use extreme caution.

UPHILL SLOPE



VEHICLE ROLL-OVER CAN CAUSE SERIOUS PERSONAL INJURY OR DEATH. PREVENT STOPPING ON A HILL WHEN TOWING OR WITH A LOADED VEHICLE. IF A VEHICLE WITH A LOAD IS STOPPED ON A HILL, PREVENT SUDDEN STARTS, ROLLING BACKWARD, AND SUDDEN STOPS.

DO NOT USE THE ACCELERATOR PEDAL TO HOLD THE VEHICLE POSITION ON A SLOPE. WHEN STOPPED ON A SLOPE, USE THE BRAKE PEDAL TO HOLD THE VEHICLE POSITION.

TO PREVENT ROLL-OVER, OPERATE THE VEHICLE SLOWLY STRAIGHT UP AND DOWN SLOPES. DO NOT OPERATE THE VEHICLE ON SLOPES THAT ARE MORE THAN A 20% GRADE.

VEHICLE ROLLBACK WHEN STARTING ON AN INCLINE CAN CAUSE PROPERTY DAMAGE, SERIOUS PERSONAL INJURY, OR DEATH. USE THE BRAKE PEDAL TO HOLD THE VEHICLE UNTIL THE DRIVETRAIN IS FULLY ENGAGED.

Precautions when on an uphill slope:

- Prevent driving on slopes that exceed 20% grade.
- Always examine the terrain carefully before driving on a slope. Do not drive on a slope with slippery or loose surfaces.
- Keep your feet on the floorboard.
- Drive in a straight line on the slope.
- Prevent driving at an offset angle. An offset angle will cause the vehicle to lean sharply to one side.
- Continue at a stable rate of speed. Do not accelerate quickly.
- Do not stop a vehicle with a load on a slope. If a vehicle with a load must stop on a slope, prevent backwards movement or sudden starts or stops.
- Do not go over the top of a hill at high speed. Obstacles, sharp drop-offs, other vehicles, or persons could be on the other side of the hill.

SIDE HILL SLOPE

 **WARNING**

TO PREVENT ROLL-OVER, PROPERTY DAMAGE, AND SERIOUS PERSONAL INJURY, OPERATE THE VEHICLE SLOWLY ON A SLOPE.

VEHICLE ROLLBACK WHEN STARTING ON AN INCLINE CAN CAUSE PROPERTY DAMAGE, SERIOUS PERSONAL INJURY, OR DEATH. USE THE BRAKE PEDAL TO HOLD THE VEHICLE UNTIL THE DRIVETRAIN IS FULLY ENGAGED.

Vehicle operation on a side hill slope is not recommended.

Precautions if driving on a side hill slope is unavoidable:

- Prevent driving on slopes that exceed 10% grade.
- Decrease vehicle speed.
- Use extreme caution.
- Always examine the terrain carefully before driving on a slope. Do not drive on a slope with slippery or loose surfaces.
- Keep your feet on the floorboard.
- Continue at a stable rate of speed. Do not accelerate quickly.

DOWNHILL SLOPE

 **WARNING**

VEHICLE ROLL-OVER CAN CAUSE SERIOUS PERSONAL INJURY OR DEATH. PREVENT STOPPING ON A HILL WHEN TOWING OR WITH A LOADED VEHICLE. IF A VEHICLE WITH A LOAD IS STOPPED ON A HILL, PREVENT SUDDEN STARTS, ROLLING BACKWARD, AND SUDDEN STOPS.

TO PREVENT ROLL-OVER, OPERATE THE VEHICLE SLOWLY STRAIGHT UP AND DOWN SLOPES. DO NOT OPERATE THE VEHICLE ON SLOPES THAT ARE MORE THAN A 20% GRADE.

USE THE BRAKE PEDAL TO CONTROL THE VEHICLE SPEED WHEN DRIVING DOWN A SLOPE.

THE OPERATOR MUST CONTROL THE VEHICLE SPEED WHEN GOING DOWN A SLOPE.

VEHICLE ROLLBACK WHEN STARTING ON AN INCLINE CAN CAUSE PROPERTY DAMAGE, SERIOUS PERSONAL INJURY, OR DEATH. USE THE BRAKE PEDAL TO HOLD THE VEHICLE UNTIL THE DRIVETRAIN IS FULLY ENGAGED.

Precautions when on a downhill slope:

- Prevent driving on slopes that exceed 20% grade.
- Always examine the terrain carefully before driving on a slope. Do not drive on a slope with slippery or loose surfaces.
- Keep the heavy end of the vehicle uphill.
- Keep your feet on the floorboard.
- Drive in a straight line on the slope.
- Prevent driving at an offset angle. An offset angle will cause the vehicle to lean sharply to one side.
- Continue at a stable rate of speed. Do not accelerate quickly.
- Decrease the vehicle speed.
- Push the brake pedal gradually to slow the vehicle.

OVER OBSTACLES

Driving over obstacles is not recommended and should be avoided.

Precautions if driving over obstacles is unavoidable:

- Always examine the terrain for obstacles before driving in a new area.
- Look forward and learn to read the terrain. Be constantly alert for hazards.
- Drive slowly and use caution when operating on unfamiliar terrain. Not all obstacles are immediately visible.
- Do not drive over large obstacles such as large rocks and fallen trees.

BELOW OBSTACLES

 **WARNING**

DO NOT OPERATE THE VEHICLE BELOW OBJECTS WITH A HEIGHT THAT IS LESS THAN THE HEIGHT OF THE VEHICLE.

Driving below obstacles is not recommended.

Precautions if operation below obstacles is unavoidable:

- Always examine the terrain for obstacles before driving in a new area.
- Look forward and learn to read the terrain. Be constantly alert for low hanging obstacles such as tree limbs.
- Drive slowly and use caution when operating on unfamiliar terrain. Not all obstacles are immediately visible.

NIGHT TIME

 **DANGER**

OPERATING THE VEHICLE AT NIGHT WITHOUT THE CORRECT EQUIPMENT CAN CAUSE PROPERTY DAMAGE, SERIOUS PERSONAL INJURY, OR DEATH. TO OPERATE THE VEHICLE AT NIGHT, THE VEHICLE MUST HAVE HEADLIGHTS, TAILLIGHTS, AND REFLECTORS.

Vehicle operation at night is not recommended. When driving at night is unavoidable, the vehicle must have:

- Headlights
- Taillights
- Reflectors

Precautions if driving at night is unavoidable:

- Always have headlights on.
- Always examine the terrain for obstacles before driving in a new area.
- Look forward and learn to read the terrain. Be constantly alert for hazards.
- Drive slowly and use caution when operating on unfamiliar terrain. Not all obstacles are immediately visible.

THROUGH WATER

 **WARNING**

DRIVING THROUGH WATER CAN DECREASE BRAKE PERFORMANCE. AFTER DRIVING THROUGH WATER, LIGHTLY PUSH THE BRAKE PEDAL TO CHECK THE BRAKE PERFORMANCE. IF THE VEHICLE SPEED DOES NOT DECREASE AT A NORMAL RATE, CONTINUE TO PUSH THE BRAKE PEDAL UNTIL THE BRAKE PERFORMANCE IS BACK TO NORMAL.

Vehicle operation through water is not recommended and should be avoided.

Precautions when driving through water is unavoidable:

- Decrease the vehicle speed.
- Use extreme caution.
- Do not drive through water that is more than 3 inches (7.62 cm) deep.

WITH CARGO **WARNING**

BEFORE A LOAD IS PUT IN THE VEHICLE, ENGAGE PARK BRAKE TO LOCK THE WHEELS.

 **CAUTION**

THE CARGO IN THE VEHICLE CAN MOVE AND AFFECT THE HANDLING, STEERING, AND BRAKES. DO NOT HAVE TOP HEAVY LOADS. SECURE THE CARGO. REDUCE THE SPEED OF THE VEHICLE AND TURN SLOW.

Hauling cargo incorrectly can change the vehicles handling and may cause loss of control or brake instability, which can cause serious injury or death.

Precautions when operating with cargo:

- Always read and understand the load distribution warnings listed on the safety labels. The total load (operator, passenger, accessories, cargo and weight on hitch) must not exceed the maximum weight capacity of the vehicle. Do not exceed the published capacities.
- Do not exceed the maximum weight capacity of the vehicle. When determining added weight to the vehicle, include the weight of the operator, passenger, accessories, loads in the rack or box and the load on the trailer tongue. The combined weight of these items must not exceed the maximum weight capacity.
- Keep the heavy end of the vehicle uphill.
- Always load the cargo box with the load as far forward and as low as possible.
- Always operate the vehicle with extreme caution when hauling or towing loads.
- Secure all loads before operating. Unsecured loads can cause unstable operating conditions, which could cause loss of vehicle control.
- Operate only with stable and safely arranged loads. When handling off-centered loads that cannot be centered, correctly fasten the load and operate with extra caution. Always attach the tow load to the hitch point designated for the vehicle.
- Heavy loads can cause braking and control problems. Use extreme caution when applying brakes with a loaded vehicle. Avoid terrain or situations that may require backing downhill. Use extreme caution when operating with loads that extend over the rack sides.
- Stability and maneuverability may be adversely affected, causing a roll over.
- Slow down and drive in the lowest gear available.
- Decrease speed and allow a greater distance for breaking when hauling cargo.
- When operating over rough or hilly terrain, decrease speed and cargo to maintain stable driving conditions.
- Do not move faster than the recommended speeds. Vehicle should never exceed 10 mph (16 km/h) while towing a load on a level grass surface. Vehicle speed should never exceed 5 mph (8 km/h) when towing loads in rough terrain, while cornering, or while climbing or going down a hill.



7

VEHICLE MAINTENANCE

⚠ DANGER

FUEL IS FLAMMABLE AND EXPLOSIVE. DO NOT SMOKE. KEEP SPARKS AND OPEN FLAMES AWAY FROM THE VEHICLE AND SERVICING AREA. DO THE SERVICING OF THE VEHICLE IN A VENTILATED AREA.

A WHEEL OR TIRE THAT HAS DAMAGE CAN CAUSE PROPERTY DAMAGE, SERIOUS PERSONAL INJURY, OR DEATH. DO NOT TRY TO REPAIR A WHEEL OR TIRE. SPEAK WITH YOUR LOCAL DEALER OR DISTRIBUTOR FOR REPAIRS.

⚠ WARNING

UNINTENDED VEHICLE OPERATION CAN CAUSE SERIOUS PERSONAL INJURY OR DEATH. BEFORE LEAVING THE VEHICLE OR DURING VEHICLE MAINTENANCE, DISABLE THE VEHICLE.

ONLY TRAINED TECHNICIANS SHOULD SERVICE OR REPAIR THE VEHICLE. ANYONE DOING EVEN SIMPLE REPAIRS OR SERVICE SHOULD HAVE KNOWLEDGE AND EXPERIENCE IN ELECTRICAL AND MECHANICAL REPAIR. THE APPROPRIATE INSTRUCTIONS MUST BE USED WHEN PERFORMING MAINTENANCE, SERVICE, OR ACCESSORY INSTALLATION.

FAILURE TO CORRECTLY MAINTAIN THE VEHICLE AND MAKE NECESSARY REPAIRS CAN DECREASE VEHICLE PERFORMANCE, CAUSE A FIRE, PROPERTY DAMAGE, SERIOUS PERSONAL INJURY, OR DEATH. IF PROBLEMS ARE FOUND DURING SCHEDULED INSPECTION OR SERVICE, OPERATE THE VEHICLE ONLY WHEN REPAIRS ARE MADE.

A HOT ENGINE AND EXHAUST SYSTEM WILL CAUSE SERIOUS BURNS. DO NOT TOUCH A HOT ENGINE OR EXHAUST. BEFORE SERVICING, LET THE ENGINE AND EXHAUST SYSTEM COOL.

MOVING PARTS CAN CRUSH AND CUT. DO NOT DO THE VEHICLE MAINTENANCE WITH THE ENGINE ON.

UNINTENTIONAL VEHICLE STARTUP CAN CAUSE A FIRE, PROPERTY DAMAGE, OR SERIOUS PERSONAL INJURY. DISCONNECT THE BATTERY.

DO NOT WORK ON THE VEHICLE POWERTRAIN WHEN THE VEHICLE IS LOADED.

ELECTRICAL SHORTS CAN CAUSE A FIRE, ELECTRICAL SHOCK, SERIOUS PERSONAL INJURY, OR DEATH. PREVENT CONTACT BETWEEN POSITIVE VOLTAGE AND THE GROUND CIRCUIT. USE INSULATED TOOLS.

DO NOT WEAR LOOSE CLOTHING OR JEWELRY SUCH AS RINGS, WATCHES, CHAINS, ETC., WHEN SERVICING THE VEHICLE.

LIFT ONLY ONE END OF THE VEHICLE AT A TIME. USE A SUITABLE LIFTING DEVICE WITH 1000 LB (454 KG) MINIMUM LIFTING CAPACITY. DO NOT USE THE LIFTING DEVICE TO HOLD THE VEHICLE IN THE LIFTED POSITION. USE APPROVED JACK STANDS OF PROPER WEIGHT CAPACITY TO SUPPORT THE VEHICLE AND CHOCK THE WHEELS THAT REMAIN ON THE FLOOR.

IF WIRES ARE REMOVED OR REPLACED, MAKE SURE THAT THE WIRING AND WIRE HARNESS ARE CORRECTLY ROUTED AND ATTACHED. FAILURE TO CORRECTLY ROUTE AND ATTACH THE WIRING COULD RESULT IN VEHICLE MALFUNCTION, PROPERTY DAMAGE, SERIOUS PERSONAL INJURY, OR DEATH.

CAUTION

WEAR SAFETY GLASSES OR APPROVED EYE PROTECTION WHEN YOU DO THE SERVICING OF THE VEHICLE. WEAR RUBBER GLOVES WHEN YOU CHANGE THE ENGINE OIL.

WEAR SAFETY GLASSES OR APPROVED EYE PROTECTION WHEN YOU DO THE SERVICING OF THE VEHICLE. WEAR A FULL FACE SHIELD AND RUBBER GLOVES WHEN NEAR BATTERIES.

DISABLE THE VEHICLE

WARNING

UNINTENDED VEHICLE OPERATION CAN CAUSE SERIOUS PERSONAL INJURY OR DEATH. BEFORE LEAVING THE VEHICLE OR DURING VEHICLE MAINTENANCE, DISABLE THE VEHICLE.

1. Park the vehicle on a solid level surface.
2. Engage the park brake to prevent vehicle movement.
3. Turn the key to OFF.
4. Remove the key.
5. Set the Forward / Neutral / Reverse control (FNR) to N.
6. Put the chocks against the wheels.

VEHICLE CLEANING

CLEANING THE WINDSHIELD

Use a soft towel and water to clean the windshield. Use mild soap as necessary. Do not use a household window cleaner.

CLEANING THE VEHICLE EXTERIOR

NOTICE

MOISTURE CAN CAUSE ELECTRICAL COMPONENT DAMAGE. DO NOT USE A PRESSURE WASHER OR STEAM CLEANER TO CLEAN THE VEHICLE.

Use only commercially available automotive cleaners with a sponge or soft cloth for normal cleaning. A garden hose at normal residential water pressure is sufficient.

Use a commercially available aluminum cleaner paste and fine grade (No. 00) steel wool to remove oxidation or discoloration from aluminum.

Use non-abrasive wax products. Battery acid, fertilizers, tars, asphalt, creosote, paint, or chewing gum should be removed immediately to prevent possible stains.

Discard the waste water correctly.

CLEANING THE VEHICLE INTERIOR

NOTICE

MOISTURE CAN CAUSE ELECTRICAL COMPONENT DAMAGE. DO NOT USE A PRESSURE WASHER OR STEAM CLEANER TO CLEAN THE VEHICLE.

The seats of the vehicle will last longer with proper cleaning. Use a solution of 10% liquid soap and warm water applied with a soft cloth. Use a soft bristle brush to remove embedded dirt.

Discard the waste water correctly.

MAINTENANCE SCHEDULE

MAINTENANCE SCHEDULE OVERVIEW

A preventive maintenance program with regular maintenance can prevent excessive vehicle downtime and repair costs. Use these items to keep the vehicle in proper working condition.

- Daily Pre-Operation Safety Checklist
- Vehicle Performance Inspection
- Maintenance Service Schedule

If a vehicle is found to be in bad operational condition, remove it from operation. Removal from operation will prevent more damage to the vehicle and prevent the possible injury because of dangerous conditions.

Speak with your dealer or distributor for maintenance and repairs.

MAINTENANCE SERVICE SCHEDULE

Note: The Maintenance Service Schedule must be done more frequently on vehicles that are constantly subjected to heavy use or severe operating conditions.

INTERVAL	DESCRIPTION
Daily	Do the Daily Pre-Operational Safety Check. Do the Daily Vehicle Performance Inspection.
	Examine the engine oil level.
Monthly	Examine the tire pressure.
	Examine the engine cooling air intake. Clean as necessary.
	Clean the vehicle.

INTERVAL	DESCRIPTION
<p>50 hours / 6 months</p>	<p>Clean the battery.</p>
	<p>Examine the air filter. Replace as necessary. Examine the hose for damage. Make sure the hose clamps are tight.</p>
	<p>Have a trained technician:</p> <ul style="list-style-type: none"> • examine the electrical system • examine the front wheel alignment • examine and lubricate the brake system • lubricate the shift cable pivots • lubricate the front suspension
<p>100 hours / 12 months</p>	<p>Have a trained technician examine the:</p> <ul style="list-style-type: none"> • spark plug • pedal components • transaxle fluid • vehicle top speed • safety decals • belts
<p>Initial: 100 hours 200 hours / 12 months</p>	<p>Change the engine oil.</p>
<p>200 hours / 24 months</p>	<p>Have a trained technician adjust the valve clearance.</p>

MAINTENANCE TASKS

AIR FILTER

AIR FILTER REMOVAL

Before the air filter is removed:

- Disable the vehicle.

To remove the air filter:

1. Release the latch (1).

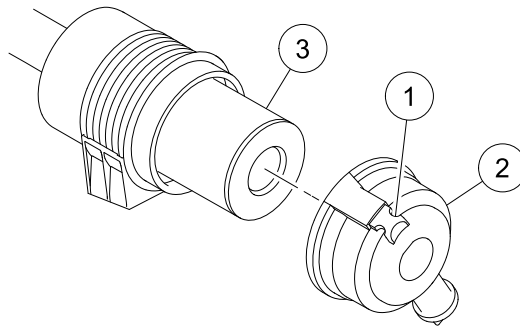

G-100398-000001

2. Remove the air cleaner cover (2).
3. Remove the air filter (3).

AIR FILTER INSTALLATION

1. Use a wet lint-free cloth to clean the inside of the air filter container.
2. Install the air filter (3).

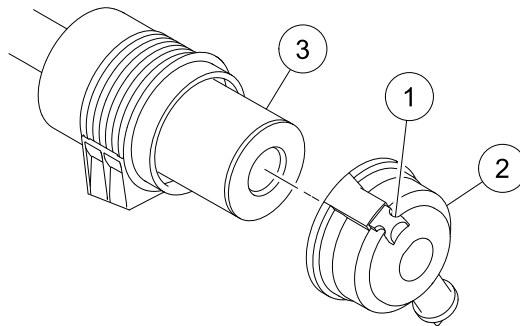

G-100398-000001

3. Install the air cleaner cover (2).
4. Engage the latch (1).

ENGINE OIL

ENGINE OIL VISCOSITY

Select the engine oil viscosity for your environmental conditions.

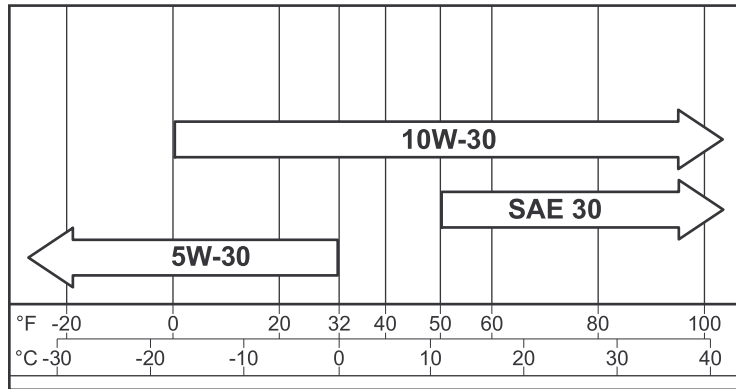

ENGINE OIL LEVEL INSPECTION

Before the engine oil is examined:

- Disable the vehicle.

To examine the engine oil:

1. Remove the dipstick (1).

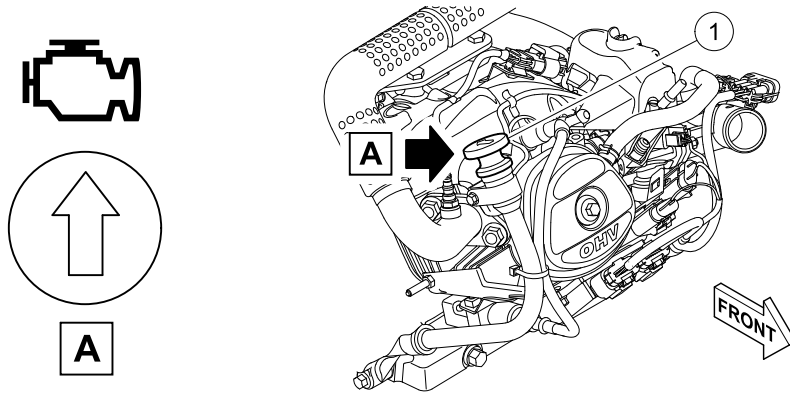

2. Make sure that there is oil on the dipstick.
3. Install the dipstick.
4. Start and operate the engine for three minutes. If the low oil warning light stays on, turn off the engine immediately.
5. Turn off the engine.
6. Wait two minutes.
7. Remove and clean the dipstick.
8. Install the dipstick.
9. Remove the dipstick.

10. Make sure that the oil level is between the maximum (1) and minimum (2) indicators.

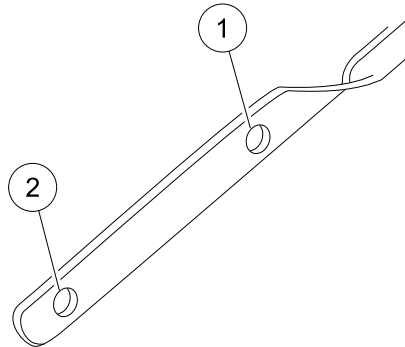

G-040698-000003

11. If the oil level is below the minimum indicator, add engine oil.
12. Install the dipstick.

Note: Make sure that the arrow points towards the engine.

ENGINE OIL REPLACEMENT

CAUTION

HOT ENGINE OIL WILL CAUSE SKIN BURNS. DO NOT CHANGE THE ENGINE OIL WHEN THE ENGINE IS HOT. LET THE ENGINE TEMPERATURE DECREASE BEFORE THE OIL IS CHANGED.

NOTICE

TOO MUCH ENGINE OIL CAN DECREASE ENGINE PERFORMANCE AND DAMAGE THE ENGINE. DO NOT EXCEED THE RECOMMENDED ENGINE OIL CAPACITY.

Before the engine oil is replaced:

- Disable the vehicle.
- Disconnect the battery.

To replace the engine oil:

1. Remove the dipstick (1).

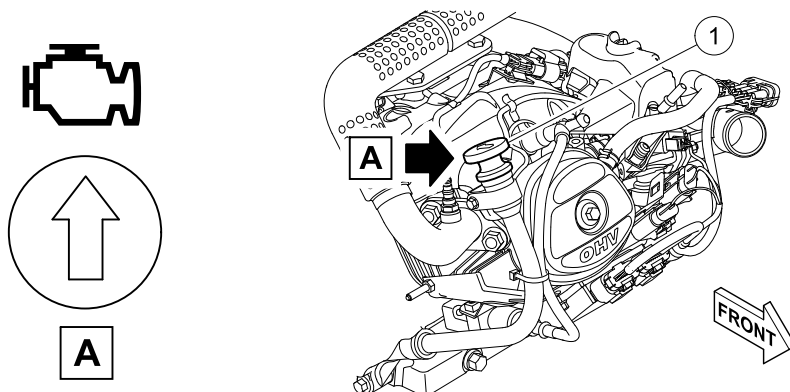

G-040698-000009

- Clean the area around the oil drain plug (2).

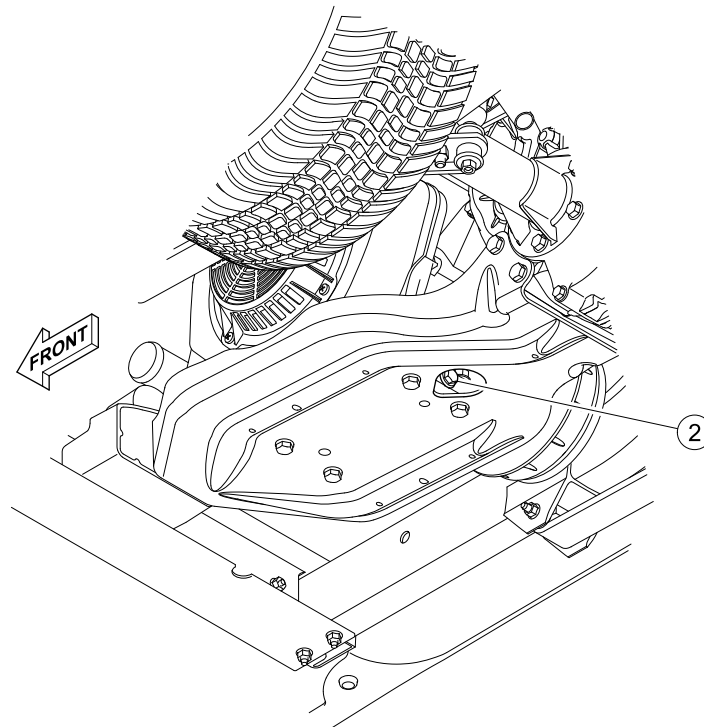

- Put a drain pan below the oil drain plug.
- Remove the oil drain plug.
- Drain the oil fully.
- Clean the oil drain plug.
- Examine the gasket on the oil drain plug for damage. Replace if necessary.
- Install the oil drain plug and tighten to 13 lb·ft (18 N·m).
- Add 39 fl-oz (1.1 l) of recommended engine oil.

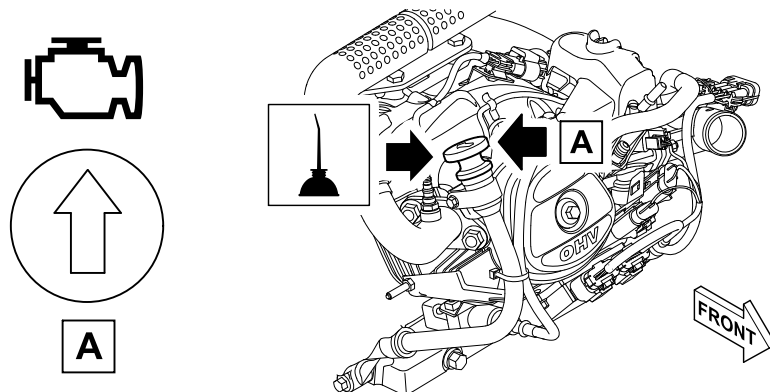

G-040698-000010

- Install the dipstick.
- Connect the battery.

12. Speak with your dealer or distributor to get more information on how to recycle the used engine oil correctly.

ADD ENGINE OIL

CAUTION

DO NOT REMOVE THE DIPSTICK WHILE THE ENGINE IS ON.

NOTICE

TOO MUCH ENGINE OIL CAN DECREASE ENGINE PERFORMANCE AND DAMAGE THE ENGINE. DO NOT EXCEED THE RECOMMENDED ENGINE OIL CAPACITY.

Before engine oil is added:

- Disable the vehicle.

To add engine oil:

1. Remove the dipstick (1).

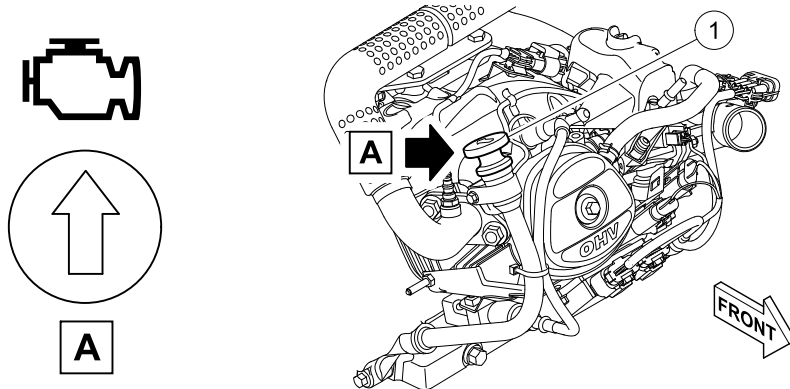

G-040698-000009

NOTICE

IF ENGINE OIL IS ADDED TOO QUICKLY, ENGINE OIL CAN LEAK OUT OF THE DIPSTICK TUBE. SLOWLY ADD ENGINE OIL.

2. Add engine oil until the oil level is between the maximum (1) and minimum (2) indicators.

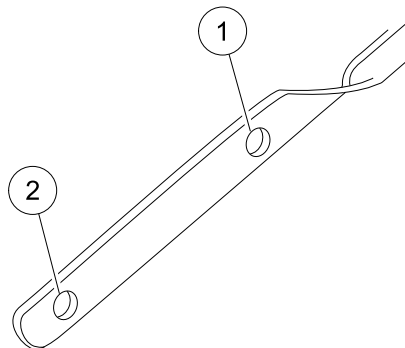

G-040698-000003

3. Install the dipstick.

REFUEL

 **DANGER**

FUEL IS FLAMMABLE AND EXPLOSIVE. DO NOT ADD FUEL WITH THE KEY SWITCH SET TO ON. BEFORE FUEL IS ADDED, TURN THE KEY SWITCH TO OFF.

FUEL IS FLAMMABLE AND EXPLOSIVE. DO NOT FILL THE FUEL TANK WHEN THE ENGINE IS ON OR HOT. WAIT FOR THE ENGINE TEMPERATURE TO DECREASE BEFORE FUEL IS ADDED.

FUEL IS FLAMMABLE AND EXPLOSIVE. DO NOT OPERATE THE VEHICLE WHEN FUEL IS SPILLED. CORRECTLY CLEAN THE SPILLED FUEL.

FUEL IS TOXIC. DO NOT SIPHON FUEL FROM THE VEHICLE.

FUEL IS TOXIC. KEEP FUEL OUT OF REACH OF CHILDREN.

FUEL IS FLAMMABLE AND EXPLOSIVE. KEEP THE FUEL IN AN APPROVED FUEL CONTAINER. KEEP THE FUEL CONTAINER IN A VENTILATED AREA AWAY FROM SPARKS AND HEAT SOURCES.

FUEL IS FLAMMABLE AND EXPLOSIVE. TO AVOID ELECTRIC ARC CAUSED BY STATIC ELECTRICITY, THE FUEL STORAGE/PUMPING DEVICE MUST BE GROUNDED. IF THE PUMP IS NOT GROUNDED, THE VEHICLE MUST BE GROUNDED TO THE PUMP BEFORE AND DURING THE FUELING OPERATION.

NOTICE

A FUEL WITH AN ALCOHOL CONTENT THAT EXCEEDS 10% BY VOLUME (LIKE E15 AND E85) WILL CAUSE VEHICLE DAMAGE AND VOID THE WARRANTY. ONLY USE THE RECOMMENDED FUEL TYPE.

1. Turn the key to OFF.
2. Let the engine cool.
3. Lift the seat bottom.

4. Remove the fuel fill cap (1).

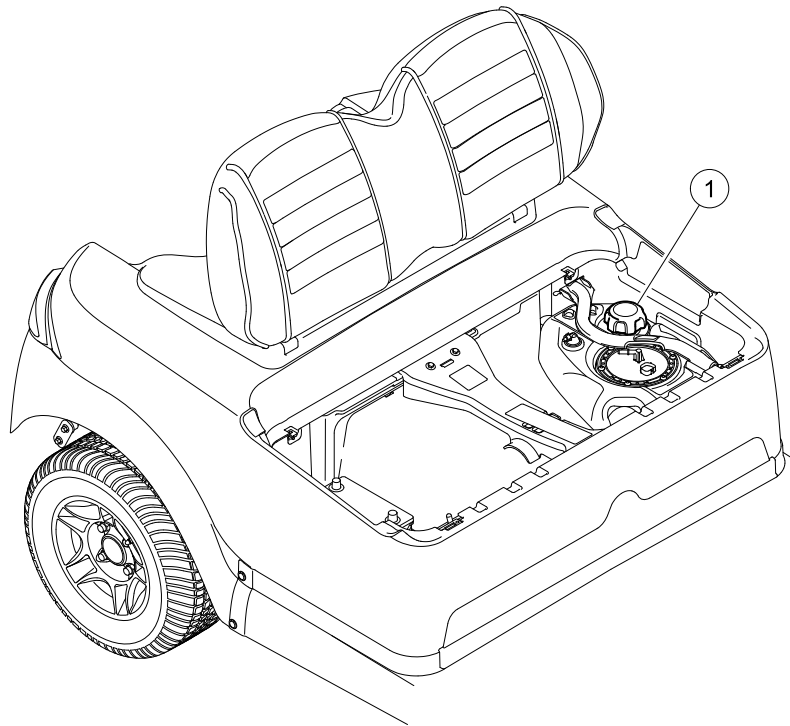

G-200096-000059

5. Fill the fuel tank with the recommended fuel.
6. Install and tighten the fuel fill cap.
7. Lower the seat bottom.

LIFT THE VEHICLE

LIFT THE FRONT OF THE VEHICLE

WARNING

LIFTING THE VEHICLE WITH CARGO CAN CAUSE PROPERTY DAMAGE, SERIOUS PERSONAL INJURY, OR DEATH. REMOVE ALL CARGO FROM THE CARGO BED BEFORE THE VEHICLE IS LIFTED.

Before the vehicle is lifted:

- Disable the vehicle.
- Disconnect the battery.
- Use a jack and jack stands rated for the vehicle.

To lift the front of the vehicle:

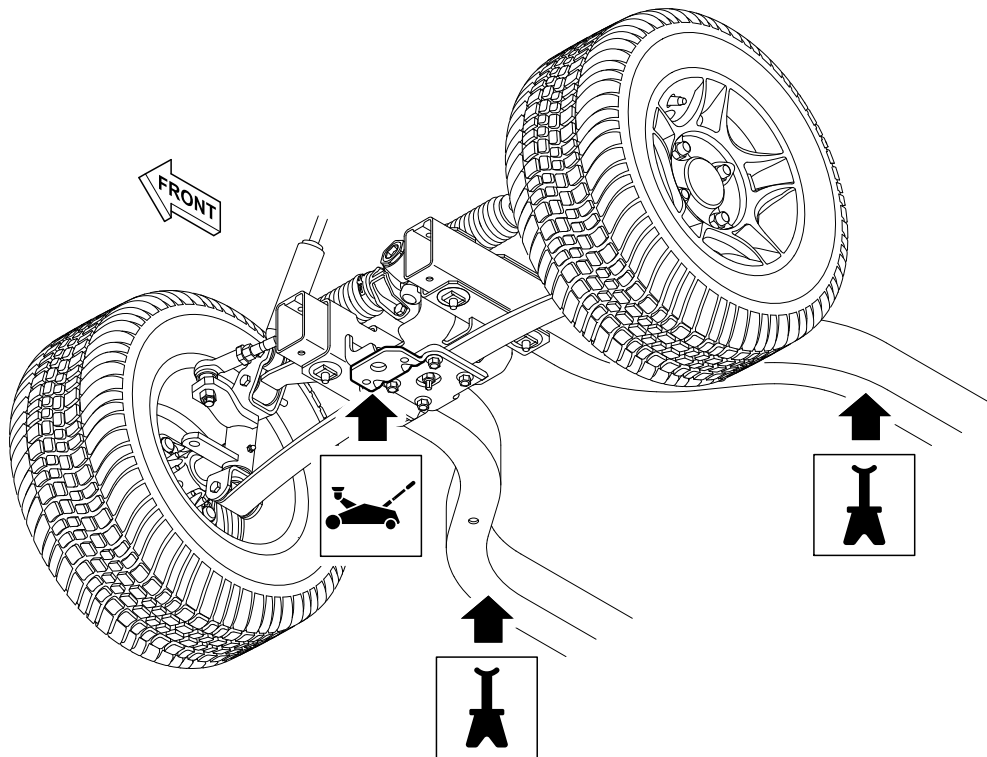

1. Place the jack in the center of the lift point.
2. Lift the front of the vehicle.
3. Put jack stands under the frame rails.
4. Lower the vehicle onto the jack stands.

LIFT THE REAR OF THE VEHICLE

⚠ WARNING

LIFTING THE VEHICLE WITH CARGO CAN CAUSE PROPERTY DAMAGE, SERIOUS PERSONAL INJURY, OR DEATH. REMOVE ALL CARGO FROM THE CARGO BED BEFORE THE VEHICLE IS LIFTED.

Before the vehicle is lifted:

- Disable the vehicle.
- Disconnect the battery.
- Use a jack and jack stands rated for the vehicle.

To lift the rear of the vehicle:

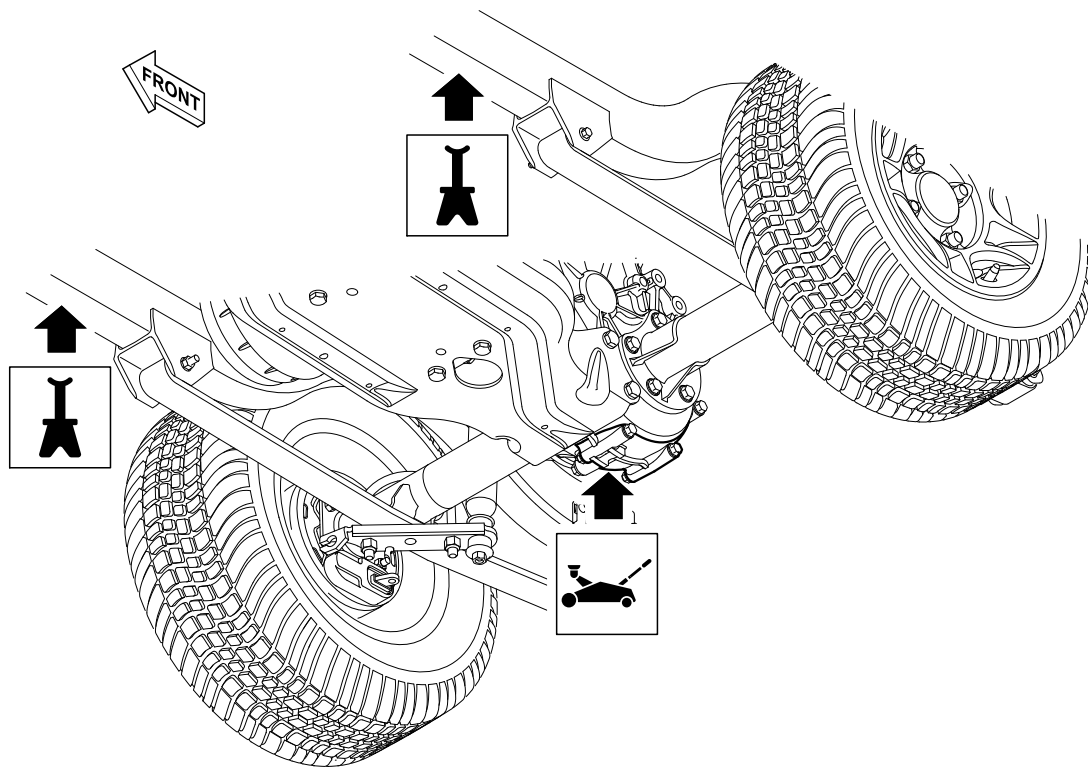

1. Place the jack in the center of the lift point.
2. Lift the rear of the vehicle.
3. Put jack stands under the frame rails.
4. Lower the vehicle onto the jack stands.

LOWER THE VEHICLE

LOWER THE FRONT OF THE VEHICLE

Before the front of the vehicle is lowered:

- Use a jack rated for the vehicle.

To lower the front of the vehicle:

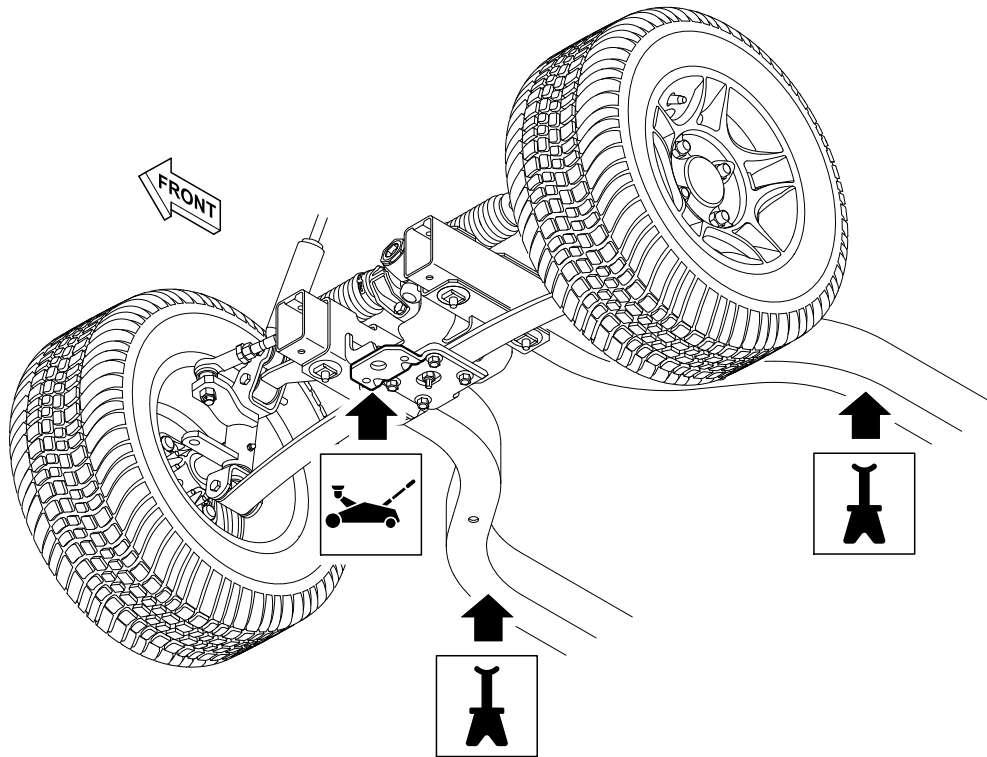

1. Place the jack in the center of the lift point.
2. Lift the vehicle off of the jack stands.
3. Remove the jack stands.
4. Lower the vehicle.

LOWER THE REAR OF THE VEHICLE

Before the rear of the vehicle is lowered:

- Use a jack rated for the vehicle.

To lower the rear of the vehicle:

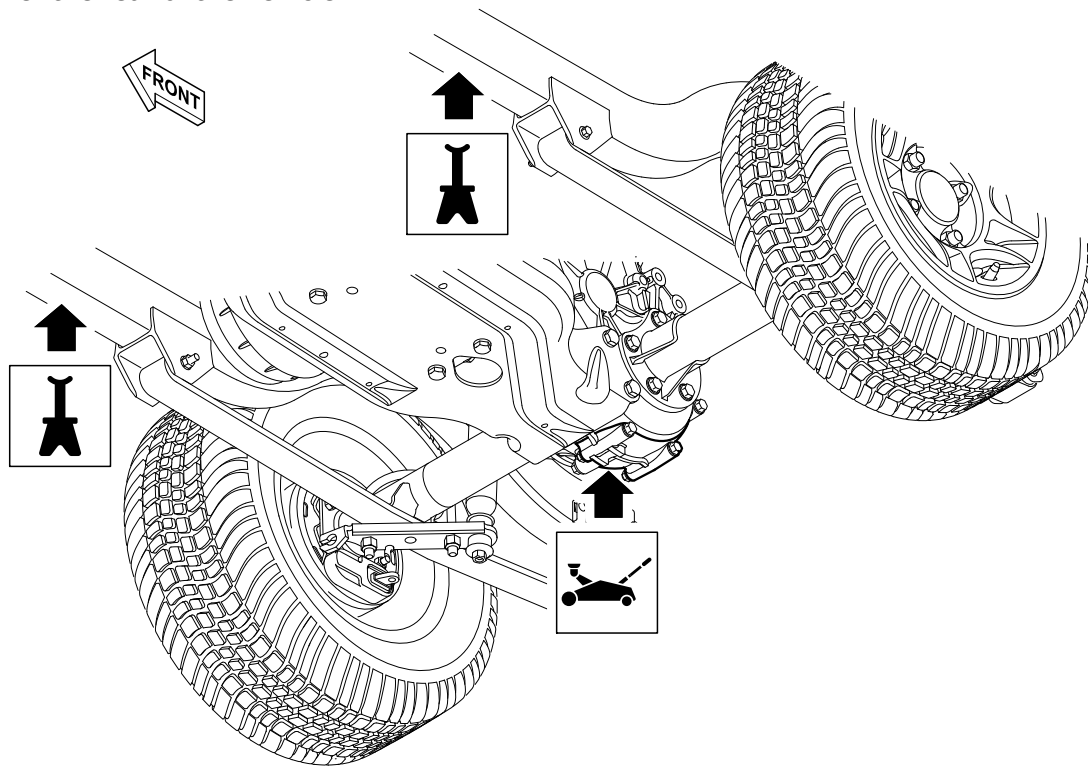

1. Place the jack in the center of the lift point.
2. Lift the vehicle off of the jack stands.
3. Remove the jack stands.
4. Lower the vehicle.

SPARK PLUG

SPARK PLUG REMOVAL

Before the spark plug removal:

- Disable the vehicle.
 - Disconnect the battery.
1. Clean the spark plug area.

- Disconnect the spark plug wire (1).

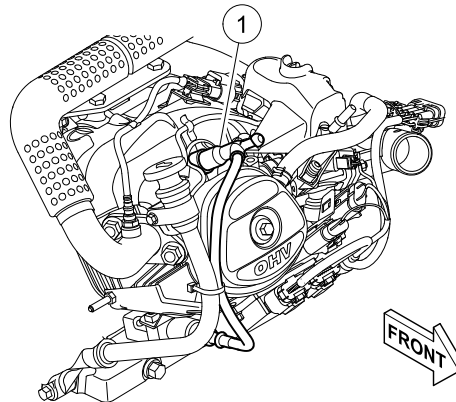

G-040798-000002

- Use a spark plug socket to remove the spark plug.

SPARK PLUG INSTALLATION

- Apply a thin layer of high temperature antiseize lubricant to the spark plug threads.
- Use a spark plug socket to install and tighten the spark plug to 20 lb·ft (27 N·m).
- Connect the spark plug wire (1).

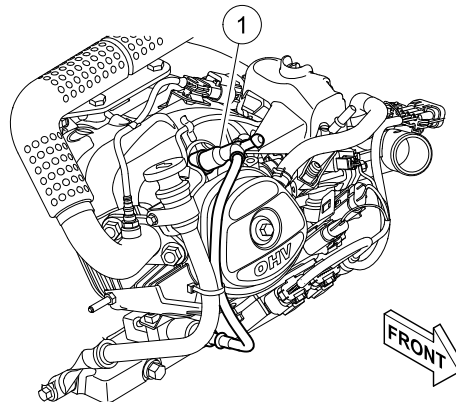

G-040798-000002

- Connect the battery.

TIRE PRESSURE MEASUREMENT

Before the tire pressure measurement:

- Disable the vehicle.

To measure the tire pressure:

- Remove the valve stem cap.
- Use a pressure gauge to measure the tire pressure.
- Adjust to meet the recommended tire pressure.

Note: Go to the approved wheel and tire assemblies matrix on <http://www.clubcar.com> for information regarding tire type, inflation pressure, and lug nut torque.

4. Install the valve stem cap.

WHEEL ASSEMBLY

WHEEL ASSEMBLY REMOVAL

Before the wheel assembly is removed:

- Disable the vehicle.

To remove the wheel assembly:

1. Remove the wheel cover.
2. Loosen the lug nuts.
3. Lift the vehicle to allow for removal of the wheel assembly.
4. Remove the lug nuts.
5. Remove the wheel assembly.

WHEEL ASSEMBLY INSTALLATION

Before wheel assembly installation:

- Disable the vehicle.

To install the wheel assembly:

1. Lift the vehicle to allow for installation of the wheel assembly.
2. Align the wheel assembly onto the hub of the vehicle.
Note: Make sure that the valve stem points to the outer side of the vehicle.

Note: Make sure that the tire tread is in the correct direction of travel.
3. Tighten the lug nuts until they are hand-tight.
4. Lower the vehicle.
5. Tighten the lug nuts to the recommended torque specification.
Note: Go to the approved wheel and tire assemblies matrix on <http://www.clubcar.com> for information regarding tire type, inflation pressure, and lugnut torque.
6. Install the wheel cover.

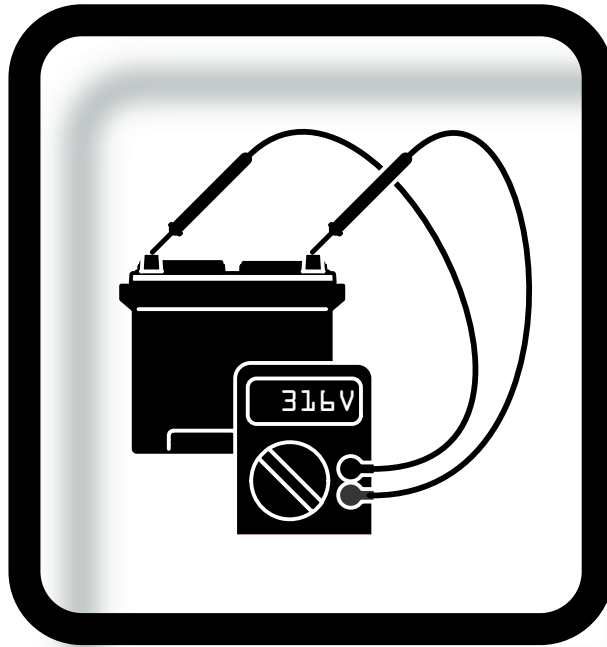

8

BATTERY MAINTENANCE

⚠ WARNING

ELECTRICAL SHORTS CAN CAUSE A FIRE, ELECTRICAL SHOCK, SERIOUS PERSONAL INJURY, OR DEATH. PREVENT CONTACT BETWEEN POSITIVE VOLTAGE AND THE GROUND CIRCUIT. USE INSULATED TOOLS.

⚠ CAUTION

WEAR SAFETY GLASSES OR APPROVED EYE PROTECTION WHEN YOU DO THE SERVICING OF THE VEHICLE. WEAR A FULL FACE SHIELD AND RUBBER GLOVES WHEN NEAR BATTERIES.

BATTERY CLEANING

1. Apply an approved battery cleaner spray or water solution to the battery top and terminals.
Note: The water solution is 1 cup (237 ml) baking soda for each 1 gallon (3.8 l) water.
2. Use a soft bristle brush to clean the battery top and terminals. Remove all corrosion.
3. Use tap water to clean the solution from the batteries. Correctly discard the waste water.
4. If the battery cable has corrosion, have a trained technician replace the battery cable.
5. Make sure the battery cables are tight. If a battery cable is not tight, tighten the hardware to 41 lb·in (4.3 N·m).
6. Let the terminals dry.
7. Apply battery terminal protector spray to the terminals.

BATTERY CHARGING

JUMP START WITH BATTERY CHARGER

⚠ WARNING

FROZEN BATTERY ACID CAN CAUSE DAMAGE INCLUDING LEAKS AND EXPLOSIONS. IF THE BATTERY ACID FREEZES, REPLACE THE BATTERY BEFORE CHARGING OR USE. BATTERIES IN A LOW STATE OF CHARGE WILL FREEZE AT LOW TEMPERATURES. KEEP THE BATTERIES IN A HIGH STATE OF CHARGE.

⚠ CAUTION

WEAR SAFETY GLASSES OR APPROVED EYE PROTECTION WHEN YOU DO THE SERVICING OF THE VEHICLE. WEAR A FULL FACE SHIELD AND RUBBER GLOVES WHEN NEAR BATTERIES.

NOTICE

THE ALTERNATOR CAN BE DAMAGED IF THE ENGINE IS OPERATED WITH THE BATTERY CABLES DISCONNECTED OR IF THE BOOSTER CABLES ARE CONNECTED INCORRECT.

Before the vehicle is jump started:

- Only use an automotive-type 12-volt battery charger rated at 10 amps or less.
1. Disable the vehicle.
 2. Turn off all accessories.
 3. Follow the battery charger manufacturer's instructions and cautions.

BATTERY ELECTRICAL CONNECTION

DISCONNECT THE BATTERY

Before the battery is disconnected:

- Disable the vehicle.

To disconnect the battery:

1. Disconnect the negative (-) cable (1).

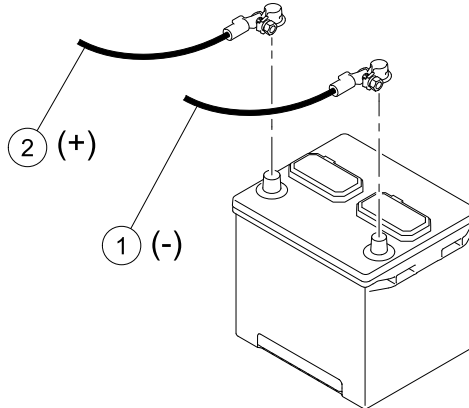

G-130798-000016

2. Disconnect the positive (+) cable (2).

CONNECT THE BATTERY

1. Connect the positive (+) cable (2).

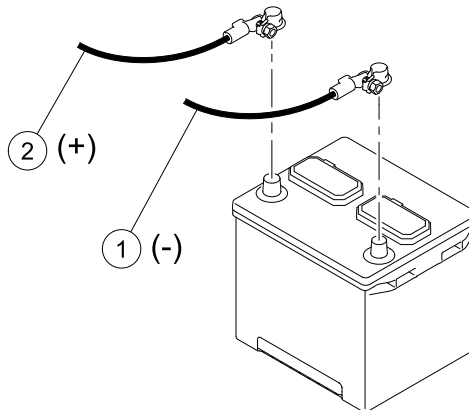

G-130798-000016

2. Connect the negative (-) cable (1).

WARNING

LOOSE BATTERY WIRES CAN CAUSE A FIRE, PROPERTY DAMAGE, OR SERIOUS PERSONAL INJURY. MAKE SURE THAT ALL BATTERY WIRES AND TERMINALS ARE CLEAN AND TIGHTENED CORRECTLY.

3. Tighten the hardware to 41 lb·in (4.3 N·m).
4. Apply battery terminal protector spray to the battery terminals.

(Page intentionally left blank.)



9

TRANSPORT AND TOW

⚠ DANGER

DO NOT LET PASSENGERS RIDE IN THE VEHICLE OR TRAILER BEING TOWED.

⚠ WARNING

KEEP AWAY FROM THE AREA BETWEEN THE TOW VEHICLE AND THE TOWED VEHICLE OR TRAILER.

DO NOT TOW A CLUB CAR VEHICLE BEHIND A PASSENGER VEHICLE OR TRUCK ON A PUBLIC ROAD. ONLY TRANSPORT A CLUB CAR VEHICLE ON AN APPROVED TRAILER.

⚠ CAUTION

THE VEHICLE CAN FALL OFF THE TRAILER AND CAUSE PROPERTY DAMAGE AND SERIOUS PERSONAL INJURY. MAKE SURE THE VEHICLE IS CORRECTLY SECURED TO THE TRAILER.

BEFORE TRANSPORTING THE VEHICLE ON A TRAILER, REMOVE THE WINDSHIELD. SECURE THE SEAT BOTTOM.

WHEN A TRAILER IS USED ON A PUBLIC ROAD, THE TRAILER MUST MEET ALL FEDERAL, STATE, AND LOCAL REQUIREMENTS SUCH AS TAILLIGHTS AND BRAKE LIGHTS.

PREPARE THE VEHICLE TO BE TOWED

1. Turn the key to OFF.
2. Remove the key. Keep the key in a safe area.
3. Set the Forward / Neutral / Reverse control (FNR) to N.

TOWING A TRAILER OR VEHICLE

This vehicle is not designed for towing operation.

TOW THE VEHICLE WITH APPROVED TOW VEHICLE

⚠ CAUTION

USE EXTREME CAUTION WHEN TOWING THE VEHICLE WITH AN APPROVED TOW VEHICLE. DO NOT MAKE SHARP TURNS WHEN TOWING THE VEHICLE. DO NOT TOW THE VEHICLE ON PUBLIC ROADS OR HIGHWAYS. DECREASE THE APPROVED TOW VEHICLE SPEED WHEN TOWING THE VEHICLE.

Approved tow vehicle:

- Can tow up to five golf cars.
- Has braking capacity of GCVWR of the approved tow vehicle plus five towed vehicles.

Note: Gross Combination Vehicle Weight Rating (GCVWR) is the gross weight of the approved tow vehicle plus the gross weight of the vehicles towed.

1. Prepare the vehicle to be towed.
2. Use a Club Car approved tow kit to tow the vehicle.
3. Use an approved tow vehicle to tow the vehicle.
4. Tow the vehicle under 5 mph (8 km/h).

VEHICLE TRANSPORT PREPARATION

 **CAUTION**

USE EXTREME CAUTION WHEN TRANSPORTING THE VEHICLE ON A TRAILER. REFER TO THE TOW VEHICLE OPERATOR MANUAL.

The vehicle is not designed to be towed at speeds over 5 mph. If movement over long distances or on public roads is necessary, transport the vehicle on a trailer. Use a trailer with appropriate load rating.

1. Set the park brake.
2. Set the Forward / Neutral / Reverse control (FNR) to N.
3. Turn the key to OFF.
4. Remove the key. Keep the key in a safe area.
5. Remove all cargo from the vehicle.
6. Remove the windshield from the vehicle.
7. Secure all doors, access panels, seat bottoms, and windshield.
8. Examine the vehicle for loose parts. Tighten as necessary.
9. Secure the vehicle to the trailer.

VEHICLE TRANSPORT RECOVERY

1. Make sure that the trailer is correctly configured to remove the vehicle from the trailer safely.
2. Remove all materials used to secure the vehicle to the trailer.
3. Examine the vehicle for loose parts. Tighten as necessary.
4. Install the windshield.

(Page intentionally left blank.)



10

EXTENDED STORAGE

⚠ DANGER

FUEL IS FLAMMABLE AND EXPLOSIVE. DO NOT OPERATE THE VEHICLE WHEN FUEL IS SPILLED. CORRECTLY CLEAN THE SPILLED FUEL.

FUEL IS FLAMMABLE AND EXPLOSIVE. DO NOT DRAIN FUEL WHEN THE ENGINE IS ON.

FUEL IS FLAMMABLE AND EXPLOSIVE. KEEP THE FUEL IN AN APPROVED FUEL CONTAINER. KEEP THE FUEL CONTAINER IN A VENTILATED AREA AWAY FROM SPARKS AND HEAT SOURCES.

FUEL IS TOXIC. KEEP FUEL OUT OF REACH OF CHILDREN.

FUEL IS TOXIC. DO NOT SIPHON FUEL FROM THE VEHICLE.

⚠ WARNING

FROZEN BATTERY ACID CAN CAUSE DAMAGE INCLUDING LEAKS AND EXPLOSIONS. IF THE BATTERY ACID FREEZES, REPLACE THE BATTERY BEFORE CHARGING OR USE. BATTERIES IN A LOW STATE OF CHARGE WILL FREEZE AT LOW TEMPERATURES. KEEP THE BATTERIES IN A HIGH STATE OF CHARGE.

UNINTENDED VEHICLE OPERATION CAN CAUSE SERIOUS PERSONAL INJURY OR DEATH. BEFORE LEAVING THE VEHICLE OR DURING VEHICLE MAINTENANCE, DISABLE THE VEHICLE.

EXTENDED STORAGE PREPARATION

To prepare your vehicle for extended storage:

1. Examine the battery state of charge (SOC) condition. If the SOC is weak, charge the battery.
Note: Use an automotive-type 12-volt battery charger rated at 10-amps or less.
2. Turn off all electronic accessories.
3. Set the Forward / Neutral / Reverse control (FNR) to N.
4. Turn the key to OFF.
5. Remove the key. Keep the key in a safe area.
6. Put chocks against the wheels.
Note: Do not engage the park brake.
7. Remove all cargo and personal items.
8. Fill the fuel tank.
9. Add a fuel stabilizer. Refer to the fuel stabilizer manufacturer's instructions.
10. Disconnect the fuel vent line from the fuel tank vent nipple.

11. Plug the fuel tank vent nipple with a slip-on vinyl cap (1). Make sure that the connection is air tight.

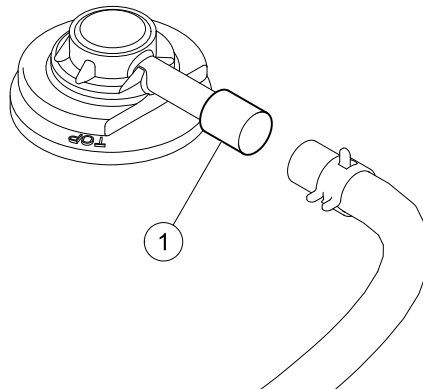

G-100498-000014

12. Disconnect the battery.
13. Clean the battery.
14. Prepare the engine for extended storage:
 - 14.A Disconnect the spark plug wire (1).

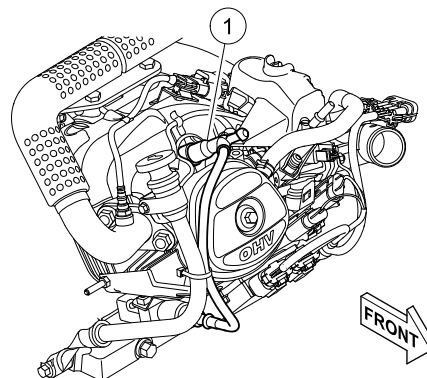

G-040798-000002

- 14.B Use a spark plug socket to remove the spark plug.
- 14.C Put 0.5 fl-oz (14.2 ml) of SAE 10 weight oil into the spark plug hole.
- 14.D Turn the engine crankshaft by hand several times.
- 14.E Apply a thin layer of high temperature anti-seize lubricant to the spark plug threads.
- 14.F Use a spark plug socket to install and tighten the spark plug to 20 lb·ft (27 N·m).
- 14.G Connect the spark plug wire.
15. Keep the vehicle in a cool and dry area to keep battery self-discharge to a minimum.
16. Adjust pressure in each tire to the recommended tire pressure.

Note: Go to the approved wheel and tire assemblies matrix on <http://www.clubcar.com> for information regarding tire type, inflation pressure, and lugnut torque.
17. Clean the vehicle.

RETURN TO SERVICE FROM EXTENDED STORAGE

1. Clean the battery.
2. Connect the fuel system:
 - 2.A Remove and discard the slip-on vinyl cap (1) from the fuel tank vent nipple.

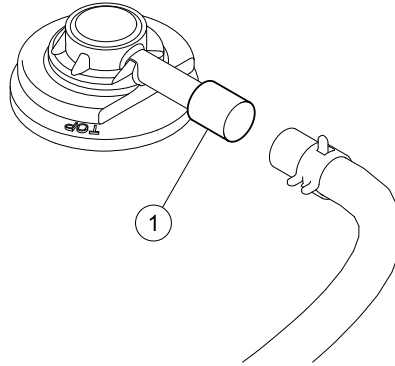

G-100498-000014

⚠ WARNING**FUEL IS FLAMMABLE AND EXPLOSIVE. MAKE SURE THAT THE FUEL TUBE IS FULLY CONNECTED.**

- 2.B Connect the vent tube to the fuel tank vent nipple.
3. Set the Forward / Neutral / Reverse control (FNR) to N.
4. Connect the battery.
5. Set the Maintenance/Operate switch to MAINTENANCE.
6. Start and run the engine.
Note: The engine exhaust may smoke for a short time after returning to service.
7. Turn the key to OFF.
8. Set the Maintenance/Operate switch to OPERATE.
9. Adjust the pressure in each tire to the recommended tire pressure.
Note: Go to the approved wheel and tire assemblies matrix on <http://www.clubcar.com> for information regarding tire type, inflation pressure, and lugnut torque.
10. Have a trained technician lubricate the vehicle.
11. Do a daily pre-operation safety checklist.
12. Do a vehicle performance inspection.



11

WARRANTIES

LIMITED WARRANTY**WARRANTY**

Club Car, LLC ("Club Car") hereby warrants to the original purchaser or lessee, as those terms are defined herein, and subject to the provisions, limitations and exclusions in this limited warranty, that its new vehicle or new component purchased from Club Car or an Authorized Dealer or Distributor shall be free from defects in material and workmanship under normal use and service for the periods stated below, subject to the provisions, limitations and exclusions in this limited warranty.

This limited warranty covers material, workmanship and repair labor cost as to those items specifically listed below for the periods specified. Such repair labor shall be performed only by Club Car, its Authorized Dealers or Distributors, or a service agency approved by Club Car. For repairs made by qualified technicians other than Club Car's factory technicians or an Authorized Dealer or Distributor, Club Car will provide only the replacement parts or components.

If the warranty registration form is not completed and returned to Club Car at the time of the original retail sale, the Purchaser must provide proof of date of purchase with any warranty claim.

WARRANTY TIMEFRAME

ITEM	SUB-ITEMS	COVERAGE
VEHICLE MAINFRAME	Not applicable	Limited Lifetime
SUSPENSION	Steering gearbox, steering column, shocks, and leaf springs	4 years
POWERTRAIN	Engine, transaxle, torque converter (drive and driven)	5 years
GASOLINE SYSTEMS	Air intake system, exhaust system, and starter generator	3 years
PEDAL GROUP	Pedal group mechanical assembly, brake cluster assemblies, and brake cables	4 years
SEATS	Seat bottom, seat back, and armrests	4 years
CANOPY SYSTEM	Canopy, rear canopy supports, drainage system, and structural accessory module (SAM)	4 years
BODY GROUP	Beauty panels and front/rear underbody	3 years
ALL REMAINING COMPONENTS	Solenoid, limit switches, voltage regulator, F&R switch, and options and accessories supplied by Club Car, including components not specified otherwise	2 years

EXCLUSIONS

Excluded from any Club Car warranty is damage to a vehicle or component resulting from a cause other than a defect including poor maintenance, neglect, abuse, accident and collision, maintenance adjustments, unreasonable or unintended strain or use, improper installation of accessories,

installation of parts or accessories that are not original equipment including Club Car approved or non-approved GPS systems, non-approved alteration, and acts of God. Also excluded from any Club Car warranty are all fuses, filters, decals (except safety decals), lubricants, routine wear items such as engine mounts, bed floor lining, mats, pads, spark plugs, light bulbs, brake pads, belts, brushes, solenoids, bushings, drive buttons, cosmetic deterioration, and items that deteriorate, fade or fail due to exposure or ordinary wear and tear.

The provisions of this limited warranty shall not apply to failure due to the following conditions:

- Batteries
 - Improper charging of a vehicle due to the use of a battery charger model not approved by Club Car for use with the vehicle.
 - Use of any accessories that do not draw power off the complete system voltage.
 - Neglect, breakage, freezing, fire, explosion, wreckage, melted terminal posts, the addition of any chemical, or the operation of the battery in an uncharged condition (below half charge 1.200 specific gravity); the installation of the batteries in reverse or recharging in reverse, breakage of containers, covers, or terminal post, or batteries used in applications for which they were not designed.
 - A battery damaged by a defective charger or batteries in vehicles that do not receive proper charging.
 - A vehicle not having an operational charger on a circuit that has the parameters specified in the vehicle operator's manual (the number of operational chargers must equal the number of operational vehicles), or use of an unapproved algorithm.
- Lack of proper maintenance such as preventive maintenance checks, proper rotation of vehicles in a fleet application, maintaining proper tire pressure and alignment and tightening loose wire connections as outlined in the operator's manual.
- Damages caused by improper installation of the component.
- Failed semiconductor parts such diodes and fuses that are vulnerable to electrical overloads (including lightning) beyond the control of Club Car.
- Damaged charger AC and DC cord set with plug, which is a wear item and subject to user abuse.
- Use of gasoline containing more than 10 percent ethanol.

Without limiting the generality of the foregoing in any way, and as part of its limited warranty exclusion, Club Car does not warrant that its vehicle or components such as batteries, computer, controller or electrical device are suitable for use in any application other than in its products. As in the use of any vehicle, batteries, computer, controller or electrical device, a prudent owner will read and study the operator's manual, the operator instructions and the warning labels; and will exercise due care in working on or around vehicles, batteries or electrical devices.

Transportation expenses for warranty services are also excluded from this warranty.

VOIDING OF WARRANTY

This and any other warranty shall be void if the vehicle or component is damaged, involved in an accident, abused or used in an unintended manner or shows indications that it has been altered in any way, including, but not limited to, modification of the speed governor, braking system, steering, transaxle, or other operating systems of the car to cause it to perform outside club car specifications. The warranty is likewise void if the vehicle shows indications that reasonable or necessary maintenance as outlined in the operator's manual and maintenance and service manual was not performed at the time and in the manner specified in such manuals.

SOLE REMEDY

Club Car's liability under this limited warranty or in any action whether based upon warranty, contract, negligence, strict product liability or otherwise, shall be the repair or replacement, at Club Car's option, of the vehicle or component thereof that Club Car deems to be defective. Replacement shall mean furnishing, during the applicable limited warranty period, a new vehicle or factory-reconditioned vehicle or component thereof that is identical or reasonably equivalent to the warranted product or component at no cost to the purchaser. Repair shall mean remedying a defect in the vehicle or component thereof at no cost to the purchaser during the applicable limited warranty period. Club Car reserves the right to test and recharge any component returned for adjustment. If Club Car elects to repair the vehicle or component, it may provide factory-reconditioned parts or components. All parts and components replaced under warranty shall become the property of Club Car.

DISCLAIMER

This limited warranty is exclusive. Club Car makes no other warranty of any kind, expressed or implied. Any implied warranties of merchantability or fitness for a particular purpose are hereby disclaimed by Club Car and excluded from this warranty. The Purchaser and Club Car expressly agree that the sole remedy of the replacement or repair of the defective vehicle or component thereof is the sole remedy of the Purchaser. Club Car makes no other representation or warranty of any kind, and no representative, employee, distributor or dealer of Club Car has the authority to make or imply any representation, promise or agreement, which in any way varies the terms of this warranty.

In the event that another pre-printed warranty document, certificate or both offered by or through Club Car at the time of sale of this vehicle (each an "Additional Warranty Document") is deemed to conflict with the limitations or exclusions contained herein, the limitations and exclusions contained herein shall continue to apply to both this limited warranty statement and, to the maximum extent permitted by law, to each Additional Warranty Document.

NO CONSEQUENTIAL DAMAGES

In no event shall Club Car be liable for any incidental or consequential damages including, but not limited to, loss related to property other than the vehicle, loss of use, loss of time, inconvenience, or any other economic loss.

Some states allow neither limitation on the duration of an implied warranty nor exclusions or limitation of incidental or consequential damages. Therefore, the above limitations or exclusions may not apply to you. This warranty gives you specific legal rights, and you may also have other rights, which vary from state to state.

HOW TO MAKE A WARRANTY CLAIM

To make a warranty claim under this limited warranty, you must present the vehicle or defective component with evidence of proof of purchase date and number of amp hours (if applicable) to an authorized Club Car dealer.

For warranty-related communication, contact:

E-mail

cci_warrantyadministration@clubcar.com

Postal Service

Club Car, LLC
Attention: Warranty Services
4125 Washington Rd.
Evans, Georgia 30809
United States Of America

FEDERAL EMISSIONS COMPONENT DEFECT WARRANTY

WARRANTY COVERAGE

This emission warranty is applicable in all States in the United States Of America, except the State of California.

Club Car, LLC ("Club Car") warrant(s) to the initial retail purchaser and each subsequent owner, that this Non-road engine ("engine") has been designed, built, and equipped to conform at the time of initial sale to all applicable regulations of the United States Of America Environmental Protection Agency (EPA), and that the engine is free of defects in materials and workmanship which would cause this engine to fail to conform with EPA regulations during its warranty period.

For the components listed under Parts Covered, the service dealer authorized by Club Car will, at no cost to you, make the necessary diagnosis, repair, or replacement necessary to ensure that the engine complies with applicable EPA regulations.

WARRANTY PERIOD

The warranty period for this engine begins on the date of sale to the initial purchaser and continues for a period of three years.

PARTS COVERED

Listed below are the parts covered by the Emission Components Defect Warranty. Some of the parts listed below may require scheduled maintenance and are warranted up to the first scheduled replacement point for that part.

EXHAUST EMISSIONS

- Fuel Metering System
 - Throttle Body, carburetor, and internal parts (and/or pressure regulator or fuel injection system)
 - Air/fuel ratio feedback and control system, if applicable
 - Cold start enrichment system, if applicable
 - Fuel pump and fuel pressure regulator
 - Fuel tank
 - Oil temperature sensor
- Air Induction System
 - Intake manifold, if applicable
 - Air filter
- Ignition System
 - Spark plugs
 - Magneto or electronic ignition system
 - Spark advance/retard system, if applicable
- Catalyst or Thermal Reactor System
 - Exhaust Manifold, if applicable
- Miscellaneous Items Used in Above Systems

- Electronic controls (ECU), if applicable
- Hoses, belts, connectors, gaskets, brackets, clamps, accessories, and assemblies used in the above systems.

EVAPORATIVE EMISSIONS

- Fuel Line
- Fuel Line Fittings
- Clamps
- Fuel Tank
- Fuel Cap
- Vapor Hoses
- Carbon Canister
- Carbon Canister Mounting Brackets
- Air Cleaner Purge Port Connector

DISTRIBUTION CENTER

Replacement parts are provided to the market upon request by the customers. Replacement parts distribution center is located at:

Club Car, LLC
Attention: Service Parts Department
4125 Washington Road
Evans, Georgia 30809,
United States Of America

WARRANTY SERVICE

To obtain warranty service, take your engine to the nearest authorized Club Car service dealer. Bring your sales receipts indicating date of purchase for this engine. The service dealer authorized by Club Car will perform the necessary repairs or adjustments within a reasonable amount of time and furnish you with a copy of the repair order. All parts and accessories replaced under this warranty become the property of Club Car.

For owners located more than 100 miles from an authorized service center, the following will be provided to those applicable owners (excluding the states with high-altitude areas). Club Car will either:

- pay for the shipping costs of replacement parts to and from an authorized service center
- provide for a service technician to come to the owner to make the warranty repair
- pay for the repair to be made at a local non-authorized service center

WHAT IS NOT COVERED

- Conditions resulting from tampering, misuse, improper adjustment (unless they were made by the service dealer authorized by Club Car during a warranty repair), alteration, accident, failure to use the recommended fuel and oil, or not performing required maintenance services.
- The replacement parts used for required maintenance services.

- Consequential damages such as loss of time, inconvenience, loss of use of the engine or equipment, etc.
- Diagnosis and inspection charges that do not result in warranty-eligible service being performed.
- Any non-authorized replacement part, or malfunction of authorized parts due to use of non-authorized parts.

OWNER'S RESPONSIBILITIES

As the engine owner, you are responsible for the performance of the required maintenance listed in your operator's manual. Club Car recommends that you retain all receipts covering maintenance on your engine, but Club Car cannot deny warranty solely for the lack of receipts or for your failure to ensure the performance of all scheduled maintenance.

As the engine owner, you should however be aware that Club Car may deny warranty coverage if your engine or a part has failed due to abuse, neglect, improper maintenance or unapproved modifications.

You are responsible for presenting your engine to the nearest service dealer authorized by Club Car when a problem exists.

If you have any questions regarding your warranty rights and responsibilities, you should contact the Club Car customer service department at:

Club Car, LLC
Attention: Service Parts Department
4125 Washington Road
Evans, Georgia 30809,
United States Of America

THINGS TO KNOW ABOUT THE EMISSION CONTROL SYSTEM WARRANTY MAINTENANCE AND REPAIRS

You are responsible for the proper maintenance of the engine. You should keep all receipts and maintenance records covering the performance of regular maintenance in the event questions arise. These receipts and maintenance records should be transferred to each subsequent owner of the engine. Club Car reserves the right to deny warranty coverage if the engine has not been properly maintained. Warranty claims will not be denied, however, solely because of the lack of required maintenance or failure to keep maintenance records.

Maintenance, replacement or repair of emission control devices and systems may be performed by any repair establishment or individual; however, warranty repairs must be performed by a service dealer authorized by Club Car. The use of parts that are not equivalent in performance and durability to authorized parts may impair the effectiveness of the emission control system and may have a bearing on the outcome of a warranty claim.

If other than the parts authorized by Club Car are used for maintenance replacements or for the repair of components affecting emission control, you should assure yourself that such parts are warranted by their manufacturer to be equivalent to the parts authorized by Club Car in their performance and durability.

HOW TO MAKE A CLAIM

All repairs qualifying under this limited warranty must be performed by a service dealer authorized by Club Car. In the event that any emission-related part is found to be defective during the warranty period, you shall notify Club Car customer service department and you will be advised of the appropriate warranty service dealer or service providers where the warranty repair can be performed.

CALIFORNIA EVAPORATIVE EMISSION CONTROL WARRANTY STATEMENT

YOUR WARRANTY RIGHTS AND OBLIGATIONS

The California Air Resources Board ("CARB") and Club Car, LLC ("Club Car") are pleased to explain the emission control system warranty on your model year 2019 vehicle engine (the "emission warranty"). In California, new equipment that uses small off-road engines ("SORE") must be designed, built and equipped to meet the State's stringent anti-smog standards. Club Car must warrant the evaporative emission control system on your vehicle engine for the period listed below provided there has been no abuse, neglect or improper maintenance of your small off-road engine leading to the failure of the evaporative emission control system.

Your evaporative emission control system may include parts such as a carburetor or fuel-injection system, fuel tanks, fuel lines (for liquid fuel and fuel vapors), fuel caps, valves, canisters, filters, clamps, connectors, and other associated components.

MANUFACTURER'S WARRANTY COVERAGE

This evaporative emission control system is warranted for two years. If any evaporative emission-related part on your Club Car small off-road engines ("SORE") is defective, the part will be repaired or replaced by Club Car.

OWNER'S WARRANTY RESPONSIBILITIES

- As the vehicle engine owner, you are responsible for the performance of the required maintenance listed in your operator's manual. Club Car recommends that you retain all receipts covering maintenance on your vehicle engine, but Club Car cannot deny warranty coverage solely for the lack of receipts.
- As the vehicle engine owner, you should be aware that Club Car may deny you warranty coverage if your vehicle engine or a part has failed due to abuse, neglect, improper maintenance or unapproved modifications.
- You are responsible for presenting your vehicle engine to a Club Car distribution center or service center as soon as a problem exists. The warranty repairs shall be completed in a reasonable amount of time, not to exceed 30 days. If you have any questions regarding your warranty coverage, you should contact:

E-mail

cci_warrantyadministration@clubcar.com

Postal Service

Club Car, LLC
Attention: Warranty Services
4125 Washington Rd.
Evans, Georgia 30809
United States Of America

DEFECTS WARRANTY COVERAGE

Club Car warrants to the ultimate purchaser and each subsequent purchaser that the small off-road engines ("SORE") and related evaporative emissions control equipment is designed, built and equipped so as to conform with all applicable California environmental emission regulations; and free from defects in materials and workmanship that cause the failure of a warranted part to be identical in all material respects to that part as described in Club Car's application for certification with CARB. The

warranty period begins on the date the engine or equipment is delivered to an ultimate purchaser or first placed into service. The warranty period is two years from the date of purchase.

Subject to certain conditions and exclusions as stated below, the warranty on emission-related parts is as follows:

1. Any warranted part that is not scheduled for replacement as required maintenance in the written instructions supplied, is warranted for the warranty period stated above. If the part fails during the period of warranty coverage, the part will be repaired or replaced by Club Car according to subsection (4) below. Any such part repaired or replaced under warranty will be warranted for the remainder of the original warranty period.
2. Any warranted part that is scheduled only for regular inspection in the written instructions supplied is warranted for the warranty period stated above. Any such part repaired or replaced under warranty will be warranted for the remaining original warranty period.
3. Any warranted part that is scheduled for replacement as required maintenance in the written instructions supplied is warranted for the period of time before the first scheduled replacement date for that part. If the part fails before the first scheduled replacement, the part will be repaired or replaced by Club Car according to subsection (4) below. Any such part repaired or replaced under warranty will be warranted for the remainder of the period prior to the first scheduled replacement point for the part.
4. Repair or replacement of any warranted part under the warranty provisions herein must be performed at a warranty station* at no charge to the owner.
5. Notwithstanding the provisions herein, warranty services or repairs will be provided at all of our distribution centers that are franchised to service the subject engines or equipment.
6. The engine or equipment owner will not be charged for diagnostic labor that is directly associated with diagnosis of a defective, emission-related warranted part, provided that such diagnostic work is performed at a warranty station.

Note: Warranty station could be Club Car, its authorized dealers, or a service agency approved by Club Car.

7. Club Car is liable for damages to other engine or equipment components proximately caused by a covered failure under warranty of any warranted part.
8. Throughout the engine or equipment warranty period stated above, Club Car will maintain a supply of warranted parts sufficient to meet the expected demand for such parts.
9. Any replacement part may be used in the performance of any warranty maintenance or repairs and must be provided without charge to the owner. Such use will not reduce the warranty obligations of Club Car.
10. Add-on or modified parts that are not exempted by the Air Resources Board may not be used. The use of any non-exempted add-on or modified parts by the ultimate purchaser will be grounds for disallowing warranty claims. Club Car will not be liable to warrant failures of warranted parts caused by the use of a non-exempted add-on or modified part.

EVAPORATIVE EMISSIONS WARRANTY PARTS LIST

The repair or replacement of any warranted part otherwise eligible for warranty coverage may be excluded from such warranty coverage if Club Car demonstrates that the engine or equipment has been abused, neglected, or improperly maintained, and that such abuse, neglect, or improper maintenance was the direct cause of the need for repair or replacement of the part. That notwithstanding, any adjustment of a component that has a factory installed, and properly operating, adjustment limiting device is still eligible for warranty coverage. The following emission warranty parts are covered:

Note: Evaporative emission-related parts will vary between vehicles; therefore, certain vehicles may not include all of the listed parts or may include equivalent part

- Fuel tank
- Fuel cap
- Fuel lines (for liquid fuel and fuel vapors)
- Fuel line fittings
- Fuel metering carburetor assembly
- Fuel regulator/filter
- Fuel injection pump
- Fuel injection nozzle
- Fuel tank vent hose
- Fuel tank rollover valve
- Fuel tank anti-slosh valve
- Throttle body assembly
- Intake air filter housing
- Intake air filter
- Intake hose
- Carbon canister, canister mounting brackets
- Crankcase breather tube
- PCV valve
- Oil filler cap
- Purge hose
- Purge valves
- Purge port connector
- Valves, hosing, tubing, fittings, seals, gaskets, clamps, and fittings as they relate to the evaporative emissions control system.

(Page intentionally left blank.)

Publication Part Number TPCC01BY00EN019

Edition Code B

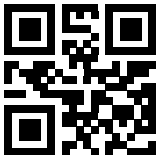

Club Car, LLC
P.O. Box 204658
Augusta, GA 30917-4658
USA

Web www.clubcar.com
Phone 1 706 258 2225
1 800 ClubCar
Fax 1 706 863 5858