

CONTENTS

1) Foreword	page 2
2) Dimensions	2
3) General description	3
4) Packaging	3
5) Disposal	3
6) Use	4
7) Installation and wiring	4
8) Operation of the appliance	5
9) Warnings regarding operation	8
10) Safety devices	8
11) Warnings regarding safety	9
12) Noise levels	10
13) Maintenance	11
14) Cleaning the appliance	11

1) FOREWORD

Read this manual from cover to cover before using the appliance as it contains important instructions for the safety, operation and maintenance of the appliance. Look after this manual and keep it in a safe place.

The manufacturer reserves the right to make changes to the product and to the manual.

2) DIMENSIONS

SUPER JOLLY
GRINDER-DOSER

	mm	inches
A	195	7 ³ / ₄
B	263	10 ¹ / ₂
C	240	9 ¹ / ₂
D	420	16 ¹ / ₂
H	610	24
Ø	212	8 ¹ / ₄

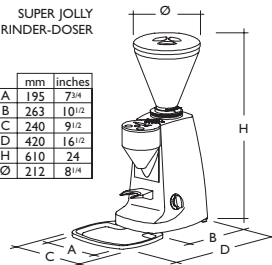

MAJOR
GRINDER-DOSER

	mm	inches
A	212	8 ¹ / ₄
B	292	11 ¹ / ₂
C	240	9 ¹ / ₂
D	455	18
H	635	25
Ø	212	8 ¹ / ₄

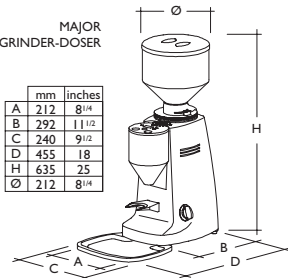

KONY
GRINDER-DOSER

	mm	inches
A	206	8
B	263	10 ¹ / ₄
C	240	9 ¹ / ₂
D	420	16 ¹ / ₂
H	650	25 ¹ / ₂
Ø	212	8 ¹ / ₄

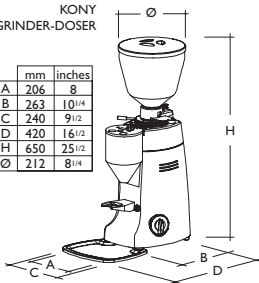

ROBUR-ROYAL
GRINDER-DOSER

	mm	inches
A	240	9 ¹ / ₂
B	310	12 ¹ / ₄
C	475	18 ³ / ₄
H	720	28 ¹ / ₄
Ø	212	8 ¹ / ₄

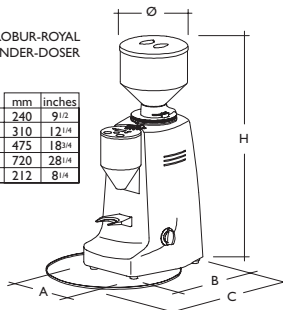

STARK
GRINDER-DOSER

	mm	inches
A	285	11 ¹ / ₄
B	240	9 ¹ / ₂
C	400	15 ³ / ₄
H	687	27
Ø	212	8 ¹ / ₄

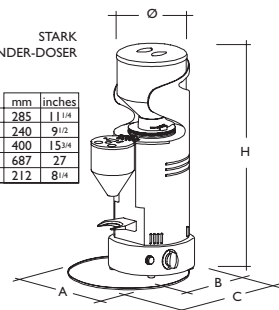

3) GENERAL DESCRIPTION

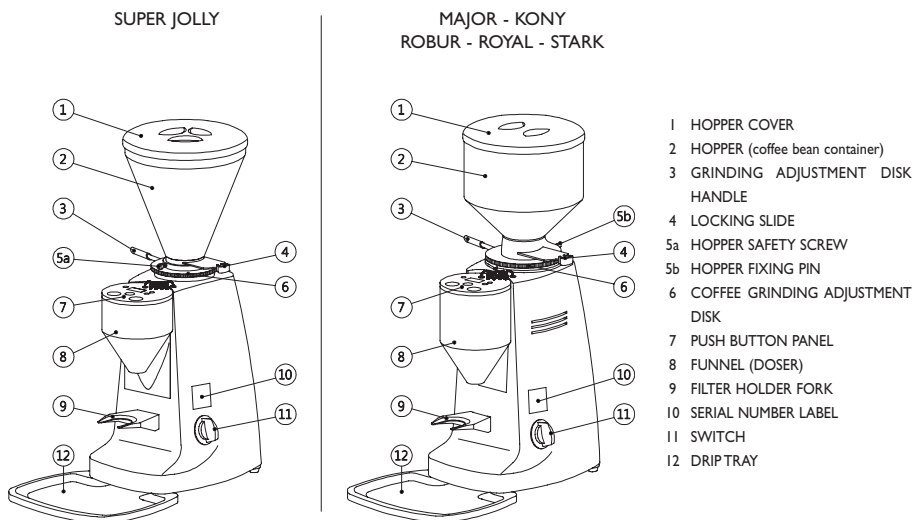

4) PACKAGING

On opening the packaging, check carefully to make sure the appliance is intact and that there are no signs of damage. If in any doubt, do not use the unit and contact personnel with the appropriate professional skills.

The packaging materials must be kept out of the reach of children as they represent a potential source of danger.

Keep the packaging until the warranty has expired.

5) DISPOSAL

Do not litter: dispose of the packaging materials according to the laws in force. Should you decide not to use the appliance any more, remember to unplug it so that it cannot be used, and then cut the cable in the point where it comes out of the appliance.

Contact specialized firms for information on the disposal of the components of the appliance.

6) USE

This appliance has been designed solely for grinding coffee beans. Any other use is understood to be improper, and consequently hazardous. The manufacturer cannot be held responsible for any damage as a result of improper or incorrect use.

Do not use the appliance for grinding other types of food, or anything else.

THE COFFEE GRINDERS AND COFFEE GRINDER-DOSERS MANUFACTURED BY OUR COMPANY ARE INTENDED FOR SKILLED PERSONNEL ONLY FOR PROFESSIONAL USE AND **NOT FOR HOUSEHOLD USE**. The user must be an adult. Do not allow children or incapable persons to use the appliance.

7) INSTALLATION AND WIRING

The appliance must be installed by skilled technical personnel in conformity with the safety rules in force. Incorrect installation may result in injury of persons or animals, or damage to property, for which the manufacturer cannot be held responsible.

- The appliance must be placed on a stable, flat surface.
- Before plugging in the appliance, make sure the voltage and frequency values of the supply mains correspond to the ratings indicated on the label featuring the appliance's technical data.
- The wall socket must be fitted with an efficient earth contact. Consequently, it is essential to make sure the earth system is efficient and in conformity with current safety rules. If in any doubt, have the system thoroughly checked by personnel with the appropriate professional skills.

IT IS COMPULSORY TO EARTH THE APPLIANCE.

The manufacturer cannot be held responsible in the event this regulation is not complied with.

- It is essential to make sure the ratings of the system are suitable for the power absorbed by the appliance - as indicated on the label featuring the technical data - and that the wall socket is protected against overcurrents.
- Do not use extension cables, plug adapters for multiple sockets or makeshift connections.
- In EEC member countries, the regulation in force calls for the external equipotential terminal  on the outer part of the appliance's base plate to be connected to a equipotential node if the installation is to be correct.
- THE HOPPER MUST BE PLACED ON THE APPLIANCE AND

PROPERLY FIXED WITH THE APPROPRIATE SCREW OR WITH THE APPROPRIATE LINCHPIN, ACCORDING TO GRINDER MODEL.

8) OPERATION OF THE APPLIANCE

PRELIMINARIES

Verify that the hopper is correctly placed on the appliance and fixed to the casing with the appropriate linchpin placed on the collar or to the top blade container with the appropriate screw, according to the grinder model.

Close the locking slide and fill the hopper with coffee beans. Open the locking slide so that the beans are allowed to drop into the grinding system.

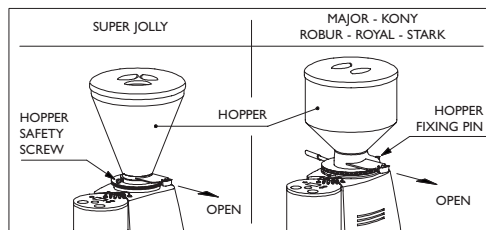

SWITCHING THE APPLIANCE ON AND OFF

In order to power up the appliance, set the on-off knob to I.

The display located on the lid of the push button panel will show a counter with the incremental number of doses ground by the appliance.

After having placed the filter holder on the filter holder fork push :

- the push-button on the left (indicating one cup) to grind and dispense a single dose;
- the push-button on the right (indicating two cups) to grind and dispense a double dose.

The counter adds one for each single dose (one cup sign) and adds two for each double dose (two cup sign).

One can manually activate the appliance keeping pushed the push button for manual grinding (indicating ) located in the centre of push-panel. Hold down the push button for manual grinding and the grinder will grind until you lift the finger. By using the push button for manual grinding no dose is added in the counter. We suggest to use the push button for manual grinding to adjust the grinding of the appliance.

In order to switch off the appliance turn the knob of the switch to O

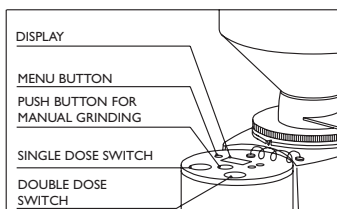

ADJUSTING GRINDING

In order to achieve finer or coarser grinding, the adjustment disk located under the hopper must be adjusted using the relevant handle.

In order to increase the coarseness of the ground coffee, the disk must be rotated clockwise; to decrease, turn the disk anticlockwise.

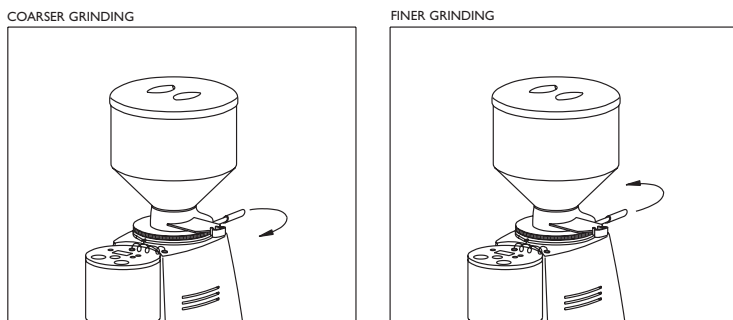

The disk remains in the chosen position without having to be locked in place.

The adjustment must be performed with the motor on, and preferably without any coffee between the grinding blades.

Grind small amounts of coffee in order to determine the optimal degree of fineness. Before checking the fineness of the ground coffee, grind some doses of coffee to fill the duct between the grinding area and the outlet. This operation must be done whenever the grinding setting has been changed in order to empty the duct of the previous ground coffee.

The change of the grinding setting might vary the weight of the doses. Therefore adjust the doses only after the grinding setting.

In the grinder-doser version, if the coffee comes out of the espresso coffee machine very quickly, it means the coffee is ground too coarse. Viceversa, if it comes out too slowly, it means the coffee is ground too fine. Nonetheless, bear in mind that there are many conditions liable to influence the correct supply, such as the weight of the portions, the compacting, the espresso machine settings, and the cleaning of the filters.

COFFEE DOSE ADJUSTMENT

In order to adjust the size of the portion dispensed, use the push button controls located on the lid of the funnel.

After having set the optimal degree of fineness, check the weight of the dose with a digital precision scale. In order to adjust the dose press the push button “MENU” for 3 seconds; the display will blink.

Select the dose you wish to adjust : either the single dose (indicating one cup) or the double dose (indicating two cups). The display will show the grinding time (in seconds) of the selected dose. By pressing the push buttons “+” and “-“ the grinding time can be increased or decreased and consequently the selected dose can be increased or decreased.

Approximately, a change of 0.10 seconds is equivalent to a change of dose of 0.3 grams (0.01 ounces).

To set the desired amount of grinding time press the push button “MENU” for 3 seconds.

A blinking of the display will confirm the data have been saved and the exit from the adjusting program.

Use a digital precision scale to check again the weight of the dose and, if necessary, repeat above mentioned operation.

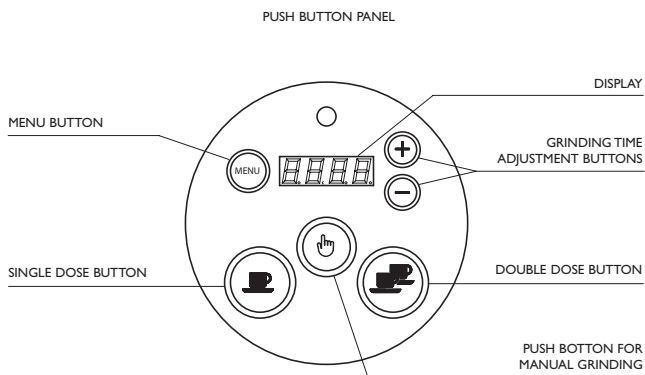

WHEN YOU ARE INSIDE THE AJUSTING PROGRAM IT IS NOT POSSIBLE TO OPERATE THE APPLIANCE.

IF THE APPLIANCE GETS SWITCHED OFF (SWITCH IN THE POSITION 0) BEFORE EXITING FROM THE AJUSTING PROGRAM THE CHANGES ARE NOT SAVED.

In order to collect the portions of ground coffee, insert the filter holder all the way onto the fork-shaped support under the ground coffee outlet.

9) WARNINGS REGARDING OPERATION

- OPERATING RANGE OF THE MOTOR

IN THE VERSIONS WITH SINGLE-PHASE MOTORS, OBSERVE THE DUTY CYCLE ON / OFF STATED IN THE LABEL LOCATED ON THE LEFT SIDE OF THE APPLIANCE.

E.g.: a data on the label 20s ON / 30s OFF point out an allowed duty cycle of 20 seconds switched on and 30 seconds switched off.

- FIRST INSTALLATION

For the correct use of the grinding blades, at the first installation or whenever the grinding blades have been replaced, grind some doses of coffee. Do not use those first doses.

For the appliance to function at its best, on its first installation and every time the hopper is cleaned, after having ground a few coffee doses, clean the inner surface of the funnel (dosing unit) with a dry brush.

10) SAFETY DEVICES

- THERMAL OVERLOAD PROTECTION

The appliance's motor is protected against overheating resulting from overcurrents by a thermal overload protection which, when tripped, cuts off the power supply to the motor. Should the protection trip as a result of anomalous operation, such as the grinding blades jamming, the appliance must be turned off using the on-off switch, UNPLUGGED FROM THE MAINS, AND SKILLED TECHNICAL PERSONNEL CONTACTED. NEVER PERFORM ANY WORK ON THE APPLIANCE WHILE IT IS ATTACHED TO THE MAINS, TO AVOID THE RISK THAT MOTOR TURNS ON SUDDENLY.

If the appliance overheats as a result of the motor stopping, allow the appliance to cool down before performing any repair work.

- MOTOR LOCKING MICROSWITCH (MAJOR, KONY, ROBUR, ROYAL, STARK)

The system that protects against accidental contact with the rotating parts of the grinding system consists of a microswitch, situated under the body of the appliance, that cuts the electricity to the motor.

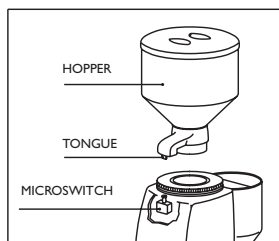
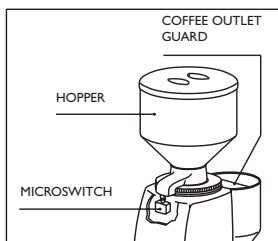

The push button that controls this device is operated by a tongue in the collar of the hopper. If the hopper is removed or not properly in place, the microswitch prevents the appliance from working. To ensure the hopper is positioned correctly it must be fixed to the casing using the relevant pin on the collar.

- SAFETY SCREWS
(SUPER JOLLY)

The hopper must always be attached to the upper grinding blade holder using the relevant screw, which must not be removed by the user under any circumstances.

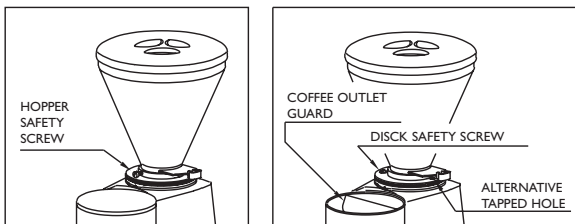

In order to prevent the adjustment disk from being removed - which would make the rotating parts accessible - there is a safety screw on the actual disk: said screw must be positioned in whichever of the two holes on the disk enables the wider and most suitable range of grinding adjustment, and must not be removed by the user under any circumstances.

- COFFEE OUTLET GUARD

The coffee outlet guard must always be fixed to the doser using the relevant screws, which must never be removed by the user.

The removal of the coffee outlet guard can be done by skilled technical personnel only after disconnecting the appliance from the power supply by unplugging. Before reconnecting the appliance to the power supply, fix the safety device to the doser by the relevant screws.

11) WARNINGS REGARDING SAFETY

This electrical appliance must be used in conformity with the rules in force governing safe operation.

- WHEN OPERATING THE APPLIANCE, BEWARE OF THE MOVING MECHANICAL PARTS' IN THE AREA OF THE GRINDING BLADES AND OF THE GROUND COFFEE OUTLET.
BEFORE REMOVING THE HOPPER FROM THE GRINDING SYSTEM, DISCONNECT THE POWER SUPPLY.
AVOID REMOVING FOREIGN BODIES FROM THE GRINDING SYSTEM OR

HOPPER WITHOUT FIRST UNPLUGGING THE APPLIANCE FROM THE MAINS.

- Take care, as the grinding blades may continue rotating for a short while even after the appliance is switched off.
- THE USER IS NOT AUTHORIZED TO REMOVE SCREWS OR ANY PARTS SCREWED ONTO THE APPLIANCE.
- In the event the appliance is not working properly or is faulty, contact skilled technical personnel, and do not attempt to make repairs yourself.
- BEFORE PERFORMING ANY WORK ON THE APPLIANCE, INCLUDING CLEANING AND/OR MAINTENANCE, DISCONNECT IT FROM THE POWER SUPPLY BY UNPLUGGING. TURNING OFF THE APPLIANCE USING ITS MASTER SWITCH DOES NOT ASSURE THE SAME CONDITIONS OF SAFETY.
- When the appliance is left unattended, the appliance's power supply must be disconnected using its master switch (for example, at night, during work breaks, midweek closing or holidays).
- Do not let liquids of any kind come into contact with the internal or external parts of the appliance.
- Never put ground coffee in the hopper intended only for coffee beans.
- Do not tamper with the appliance.
- Do not tug on the supply cable to unplug the appliance from the mains.
- Do not touch the appliance with damp or wet hands or feet.
- Do not use the appliance barefoot.

The manufacturer cannot be held responsible for bodily injury or damage to property if these regulations are not complied with.

12) NOISE LEVEL

EEC Countries:

The maximal noise emission of our coffee-grinders or grinder-dosers (valued as acoustic power) is 81 dB(A), measured in ISO 3741 reverberating chamber, according to EN 60704-1:1998 and EN 60704-3:1996.

The daily personal noise exposure of a worker, due only to an appliance's limit operation of 240 min. per eight hours, is 78 dB(A), according to ED 86/188/EEC and ED 2003/10/EEC. Therefore during the appliance's normal operation, no provisions are to be taken in order to prevent such risks arising or likely to arise from noise exposure at work (articles 3-8 of ED 2003/10/EEC).

USA & CANADA:

The noise level of our appliances is included within the limits stated in U.S. regulation 29 CFR 1910.95 ('Occupational Health and Environment Control - Occupational noise exposure') for eight hours continuously in a day.

Said noise level has been determined on identical news appliances.

13) MAINTENANCE

It is essential to check the state of the supply cable and plug periodically.

IN THE EVENT THE SUPPLY CABLE OR PLUG ARE DAMAGED, CALL IN SKILLED TECHNICAL PERSONNEL TO REPLACE THEM, THIS TO PREVENT ANY RISK.

IN **CE** - CERTIFIED APPLIANCES, A SPECIAL TOOL IS REQUIRED TO OPEN THE BASE PLATE TO GET AT THE CABLE.

It is recommended to use original spare parts only.

In order to assure the lasting efficiency of the appliance, skilled technical personnel must be called in to perform periodical maintenance, including detailed checks of the state of those components subject to wear.

The state of the grinding blades must be checked periodically. Keeping the grinding blades in an excellent state assures high-quality grinding, resulting in greater productivity and limited overheating.

14) CLEANING THE APPLIANCE

DISCONNECT THE APPLIANCE'S POWER SUPPLY BY UNPLUGGING IT BEFORE CLEANING.

THE APPLIANCE MUST NOT BE CLEANED USING WATER JETS.

Do not install the appliance in rooms where water jets are used for cleaning.

THE APPLIANCE MUST BE CLEANED PERIODICALLY BY SKILLED TECHNICAL PERSONNEL ONLY.

Use perfectly clean, disinfected cloths or brushes for cleaning.

Do not use abrasive products as these are liable to take the sheen off shiny parts.

Hopper

Wash the hopper after having removed it from the appliance, with water and neutral soap, rinse it accurately with warm water and dry perfectly well.

It is advisable to regularly clean the hopper.

After cleaning operations, the hopper must be correctly fixed to the appliance with the appropriate linchpin or appropriate screw.

Grinding system

After having removed the safety screw, if the appliance is fitted with one, preventing removal of the grinding adjustment ring, remove the ring by rotating it clockwise. Remove the top blade container and clean the blades, the threads and the entire grinding system with a brush and a dry cloth.

After having placed the top blade container back into place, screw the adjustment ring and insert, in models fitted with one, the tamper-proof screw in the hole allowing most adjustment. Place the hopper back into place and then set the grind adjustment.

Funnel

After having removed the lid with the operating switches, clean the funnel and its lid with a dry and disinfected brush.

Mazzer Luigi srl

All right reserved. It is prohibited to reproduce, adapt or translate this document without prior written authorization.

First Edition: March 2007

Last revised: EL02 07/2010