

# TPC Ultrasonic Cleaner

Dentsonic UC 250

## USER MANUAL

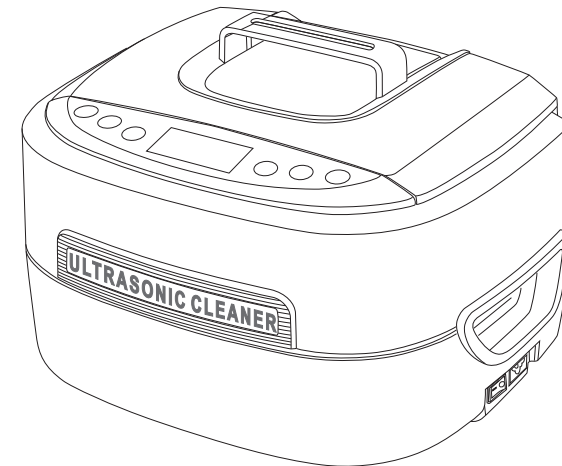

### FEATURES

- 1 Lengthened tank** Tank capacity: 2500 ml / 2.6 Qt; Size 24.5x15.0x7.6 cm / 9.6"x5.9"x3.0". Longest item that can fit is 26.0 cm / 10.2"
- 2 Control panel with capacitive sensing technology** Durable, reliable, resistant to water and harsh chemicals
- 3 Industrial ultrasonic transducer**  $\Phi$ 38mm industrial transducer(60W),with stronger cleaning effect
- 4 2-color LED display** 1 to 30-minute full range timer, degas feature
- 5 Ceramic heater** 100W ceramic heaters
- 6 Multiple circuit protectors** When overloaded or improperly used, the protectors shut down the power to certain areas to protect the machine
- 7 Cooling fan** Improves heat dissipation and beneficial for continuous operations
- 8 Detachable power cord** Independent power switch and detachable power cord, convenient to use
- 9 Moisture-proofed PCB and industrial grade IC** Capable for different working environment with better anti-interference performance
- 10 Engineering grade plastics** 4mm wall thickness with tongue and groove joints, with better impact and water-proof performances

## SPECIFICATIONS

<b>Description</b>	TPC Ultrasonic Cleaner	
<b>Model</b>	UC 250	
<b>Tank Capacity</b>	2500 ml / 2.6 Qt (US)	Max. 2100 ml / 2.2 Qt (US)
		Min. 600 ml / 0.6 Qt (US)
<b>Tank Size</b>	24.5 x 15.0 x 7.6 cm / 9.6" x 5.9" x 3.0"	
<b>Longest Item Fits inside Tank</b>	26.0 cm / 10.2"	
<b>Power Supply</b>	160 W ( AC 100~120V 50/60Hz)	
	170 W (AC 220~240V 50/60Hz)	
	130 W (AC 100V 50/60Hz)	
<b>Digital Timer Settings</b>	1 to 30-minute full range timer	
<b>Ultrasonic Frequency</b>	35,000 Hz	
<b>Tank Material</b>	Stainless Steel SUS304	
<b>Housing Material</b>	ABS	
<b>Net Weight</b>	2.9 kg / 6.4 lb	
<b>Gross Weight</b>	3.5 kg / 7.7 lb	
<b>Unit Size</b>	31.4 x 24.3 x 20.4cm / 12.4" x 9.6" x 8.0"	
<b>Inner Carton Size</b>	35.6 x 27.5 x 24.2 cm / 14.0" x 10.8" x 9.5"	
<b>Qty per Master Carton</b>	4 pcs /ctn	
<b>Master Carton Size</b>	57.0 x 37.5 x 51.5 cm / 22.4" x 14.8" x 20.1"	

## INTRODUCTION

**Use tap water. Special solutions are not necessary in most cases.**

### Principles of ultrasonic cleaning:

Millions of tiny air bubbles are generated within liquid by high frequency vibration. The air bubbles burst when in contact with object and dislodge the debris to achieve the cleaning effect.



- Using tap water is sufficient. Purified water or distilled water has the same cleaning effect as regular tap water for ultrasonic cleaning.
- When cleaning silver or copper items where oxidation has darkened the items, special solutions needs to be added to the water to remove the oxidation.

### Main Features

- Tank capacity: 2500 ml / 2.6 Qt . Size: 24.5x15.0x7.6 cm / 9.6"x5.9"x3.0". Longest item that can fit inside the tank is 26.0 cm / 10.2".
- Use stronger industrial grade  $\Phi$ 38 ultrasonic transducer (60 W), good clean effect.
- Control panel with capacitive sensing technology: Durable, reliable, resistant to water and harsh chemicals .
- Ceramic heater (about 100 W) 65 °C temperature limited.
- 2-color LED display. 1 to 30-minute full range timer. Degas feature.
- Industrial grade IC. Moisture-proofed PCB. Cooling fan. Thermal cutoff, overheat protector, internal safety timer for heater. Improved product durability.
- 4 mm wall thickness with tongue and groove joints for better impact and water-proof performances.

### Read the Manual First

The manual should be carefully reviewed before starting to use the device. Warnings should be observed carefully. Please follow the manual for operations.

## TABLE OF CONTENTS



Safety Precautions .....	1,2
Items Not Suitable for Ultrasonic Cleaning .....	2
Applications .....	3,4,5
Sample Applications .....	5,6
Product Explosion Picture .....	7,8
Product Structure and Accessories.....	9
Control Panel and Operations .....	10
Common Cleaning Methods .....	11,12
Operation Guidelines .....	13,14
Care and Maintenance .....	14
Specifications .....	15

## SAFETY PRECAUTIONS

### Keep it away from children!

-  This appliance can be used by children aged from 8 years and above if they have been given supervision or instruction concerning use of the appliance in a safe way and if they understand the hazards involved. Cleaning and user maintenance shall not be made by children unless they are aged from 8 years and above and supervised. Keep the appliance and its cord out of reach of children aged less than 8 years.
- Please store the ultrasonic cleaner where it is not reachable by children.
- Danger to children! Danger for death through suffocation! Keep the packaging material away from children.
- This appliance shall not be used by children. Keep the appliance and its cord out of reach of children.

### To prevent life-threatening electrical shock, please observe the following:

-   **Danger of electrical shock!** Do not use while bathing. Never immerse the device or the power cord in water or other liquid.

- Danger of electrical shock!** Never touch the power plug with wet hands, especially when inserting or removing the plug.
- Danger of electrical shock!** If the unit has fallen into water during operation, do not touch the unit. Remove the power plug from the socket first.
- Danger of electrical shock!** Do not spray water or liquid over the device.
- Never operate the device unattended.
- Follow the manual to operate the device.
- Do not use components unapproved by the manufacturer.
- When removing the power cord from the socket, grab the power plug not the cord.
- To protect the power cord from damage, do not cause it to get caught by things such as a cupboard door or a chair leg; do not drag across a hot surface.
- If there is damage to the power plug, cord, housing, or other parts of the device, do not use the device.
- Do not disassemble the device, except by professionals.
- If the unit is damaged, non-operational or has fallen into water, take it to a qualified service provider.
- Remove the power plug from the socket
  - if malfunction occurs
  - before cleaning the device
  - if the device is not going to be used for prolonged period
  - after each use (recommended)
- The installation of an earth leakage circuit breaker with a rated tripping current of no more than 30 mA provides further protection against an electrical shock. The installation should only be carried out by a trained electrician.

### To prevent fire hazards, please observe the following:

- Never block the vents on the device. Keep the vents free from lint, hair and other materials.
- Do not place the device on a soft surface, such as a bed or a couch, where the vents could be blocked.
- Observe the other warnings in the previous section.
- If the supply cord is damaged, it must be replaced by the manufacturer or its service agent or a similarly qualified person in order to avoid a hazard.

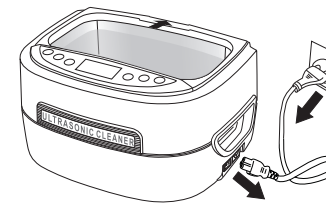

- 5** When cleaning is completed, turn off the switch, remove the lid and retrieve the items. Pour water out through the pouring recess. Clean and wipe the tank dry.

## CARE AND MAINTENANCE

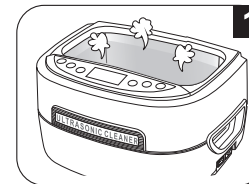

- 1** Do not turn on the unit without water in the tank. Even though the unit is designed with multiple protections, if it is turned on for over 30 seconds without water in the tank, it may damage the unit or severely reduce the life of the unit. If heating over 3 minutes, it will damage the heater.

 This unit is equipped with a thermal cutoff. If the cleaning function is turned on without water in the tank, the temperature will rise continuously. The thermal cutoff will be actuated after approximately 15 minutes respectively to ensure safety. The unit will be disabled until it's repaired.

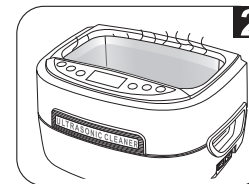

- 2** Do not run the unit for extended time or continuously. The unit is designed with overheat protection. If the unit has been running for 45 minutes, it is recommended to stop the unit for about 20 minutes to prolong the life of the unit.

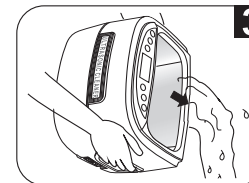

- 3** Do not keep water in the cleaning tank for a long time. After cleaning is completed, turn off the switch then pour water out through the pouring recess. Avoid getting water inside the housing through the vents and causing damage.

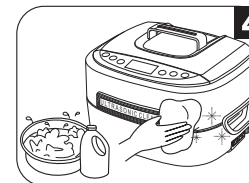

- 4** Do not spray water over the housing. Use a towel to wipe the tank and the housing.

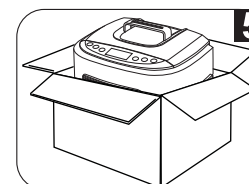

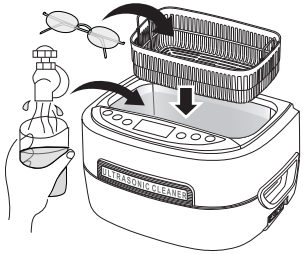

- 5** Do not expose the unit under direct sunshine for a long. Keep the unit in a dry, cool and ventilated area.

## OPERATION GUIDELINES



- 1 Remove the lid, put the items in the basket then put them in the cleaning tank. Add water to a level between MIN and MAX and above the area to be cleaned.

 If the unit is turned on without water, ultrasonic energy will not be absorbed. Once over 30 seconds, it may damage the unit or severely reduce the life of the unit.

- 2 Connect the power cord to an outlet and turn the switch on. LED display shows . This is the most

commonly used time setting and working state. If the time needs to be adjusted, press Time button and  button. The time can be set between 1 to 30 minutes. Common cleaning time are 5, 10 or 15 minutes.

Prolonged cleaning time may result in:

- a. Loosening of the screws if used.
- b. Increasing the pre-existing cracks.
- c. Peeling of coating which was already separated.

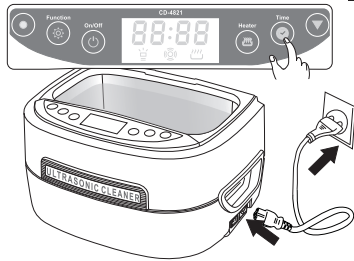



- 3 Press On/Off button to start cleaning.

During cleaning, buzzing sound can be heard from the cleaning tank, indicating the cleaning is underway. Closing the lid will reduce the noise.

LED display will count down to show the remaining cleaning time. When it displays , the cleaning is done. To stop cleaning at any time, press On/Off button.

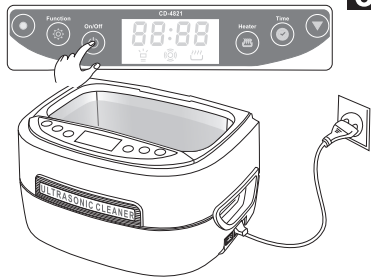
The unit is designed with overheating protection to avoid damage caused by extended and continuous operation. When the red light is on, the unit will not turn on even it is forced to. The unit will idle for about 20 minutes then can be restarted after the green light comes on.



- 4 Select one of the four cleaning methods recommended earlier.
  - a. When the heater is needed, press Heater button,  flashes, indicating the heater is turned on. When water temperature reaches 60°C (140°F) the heater will turn off automatically.

To ensure safety, the unit is designed with dual protections. The heater will be turned off automatically if it has been running for 45 minutes.

- b. To speed up the mixing when solution is used, degas function can be used. Press Time button to set the timer. Press Function button,  illuminates. Press On/Off to start degassing. It changes over to normal cleaning after 90 seconds.
- c. When debris "smoke" is no longer visible, cleaning is done. If additional cleaning is needed, press Time button to reset the timer and repeat the steps above.

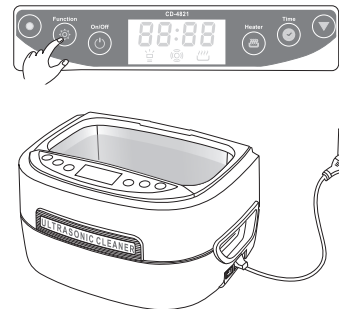

## SAFETY PRECAUTIONS



### Other observations:

- Do not operate the product without filling the tank with water. Running dry will damage the unit.
- Do not plug in the power cord before adding water to the tank. Do not fill the tank above the Max line to avoid overspill.
- Do not use solution containing abrasive substances or strong corrosive chemical solution not recommended by the manufacturer or the supplier.
- Place the device on a dry and flat surface for operation.
- When the device is subjected to severe electromagnetic interference, it may malfunction, stop operating or lose control functions. If this happens, unplug the power cord then reinsert it to restart the device.

## IMPORTANT SAFETY INSTRUCTIONS



### When using electric appliances, basic precautions should always be followed, including the following :

- Read all the instructions before using the appliance.
- To reduce the risk of injury, close supervision is necessary when an appliance is used near children.
- Only use attachments recommended or sold by the manufacturer.
- Do not use outdoors.
- To disconnect, turn all controls to the off (O) position, then remove plug from outlet. Do not unplug by pulling on cord. To unplug, grasp the plug, not the cord. Unplug from outlet when not in use and before servicing or cleaning.
- To reduce the risk of electrical shock, do not put the appliance in water or other liquid. Do not place or store appliance where it can fall or be pulled into a tub or sink.
- All servicing of this product, including transducer replacement, is to be conducted by qualified service personnel.
- Do not operate any appliance with a damaged cord or plug, or after the appliance malfunctions or is dropped or damaged in any manner. Return appliance to the nearest authorized service facility for examination, repair, or electrical or mechanical adjustment.



### Items Not Suitable for Ultrasonic Cleaning

<b>Soft Jewelry:</b> Pearls, emerald, ivory, coral, agate, sea turtle shells, etc	These items are not hard, so scratches may occur during cleaning.
<b>Welded, Plated and Glued Items:</b> Welded or plated metal items, glued items	Ultrasonic cleaning may enlarge the gaps inside the welded joints, plated coating or glued items and may cause separation.
<b>Watches:</b> Except diver's watches with depth rating over 50 m (150 ft) .	Because the strong penetration capability of the ultrasonic waves, water may get into the watches if they are not truly waterproof. Use the watch stand supplied as a precaution if not sure.
<b>Others:</b> Wood; coated glass, ceramic, camera filters with preexisting cracks.	Ultrasonic cleaning may enlarge the cracks pre-existed in the coating on the glasses, ceramic, and glass. If the items have no pre-existing cracks, then it is okay.





# CONTROL PANEL AND OPERATIONS

## 1. Indicator Light - Working Status

Green - Normal working status, ready to use.

Red - Under overheat protection. 15 minutes of waiting time is needed for the light to change from red to green. Work can resume afterwards.

## 2. Function Button - Functions (Degas/Normal)

Press Function button,  illuminates, indicating Degas function is selected. Press On/Off button to start degas.  will flash for about 90 seconds, then the unit will return to normal cleaning function. Pressing Function button before it ends will stop degassing. If additional degassing is needed after it ends, press Function button again.

### Degas

When cleaning heavily soiled or greasy items, silver, copper or brass items, chemical solutions need to be added into the water. The solution may form many small droplets and take a long time to dissolve in the water. Newly added water may generate many air bubbles on the tank walls. These will reduce the cleaning effect in the beginning phase of ultrasonic cleaning. Turning on the degas function will dissipate the droplets and the air bubbles, usually in 90 seconds, and improve cleaning efficiency.

## 3. On/Off Key - On/Off Switch for the Unit

After powering on, the LED displays  which is the default time and the unit is ready with normal working status.

Press On/Off button once and the cleaning starts. The cleaning stops when the timer counts down to . If the unit needs to be stopped before the timer runs up, press On/Off button.

4.  Digital LED display of working time. It counts down after work being started.



## 5. — Degas Status



 — Illuminated, the degas function is selected.  — Flashing, degassing is underway.



## 6. — Normal Cleaning Status

 — Illuminated, normal cleaning is underway.

## 7. — Heater Status

Press Heater button,  flashes, indicating the heater is turned on. Press Heater button again,  dims, indicating the heater is turned off.

8. **Heater Button** — Heater button. Pressing Heater button,  flashes, indicating the heater is turned on. To cancel heating, press Heater,  dims, indicating the heater is turned off.

9. **Timer Button** — Timer quick set button. Press Timer button, LED display shows . Pressing it again to Timer it to . Each pressing makes it to increase by 5 minutes.

10. **▼ Button** — Timer decreasing button. Each pressing reduces the timer by 1 minute.

# PRODUCT STRUCTURE AND ACCESSORIES

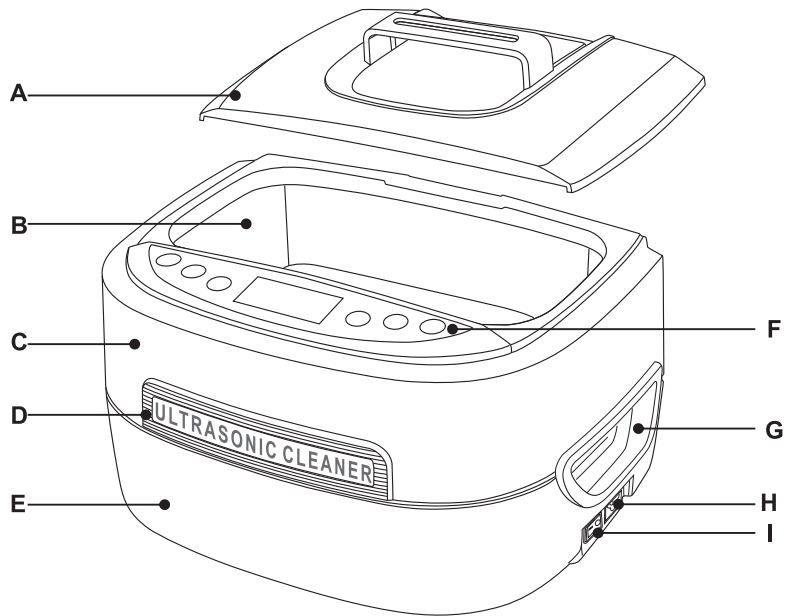

- A.** Top cover
- B.** Stainless steel tank
- C.** Top housing
- D.** Logo block
- E.** Bottom housing
- F.** Control panel
- G.** Handles
- H.** Power socket
- I.** Power switch



Power cord

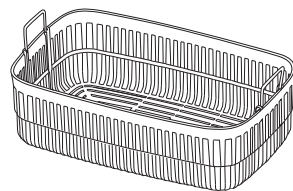

Plastic basket

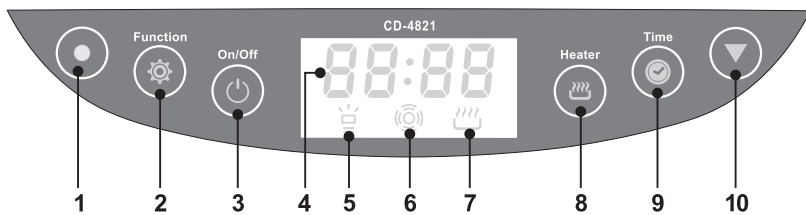

# PRODUCT EXPLOSION PICTURE

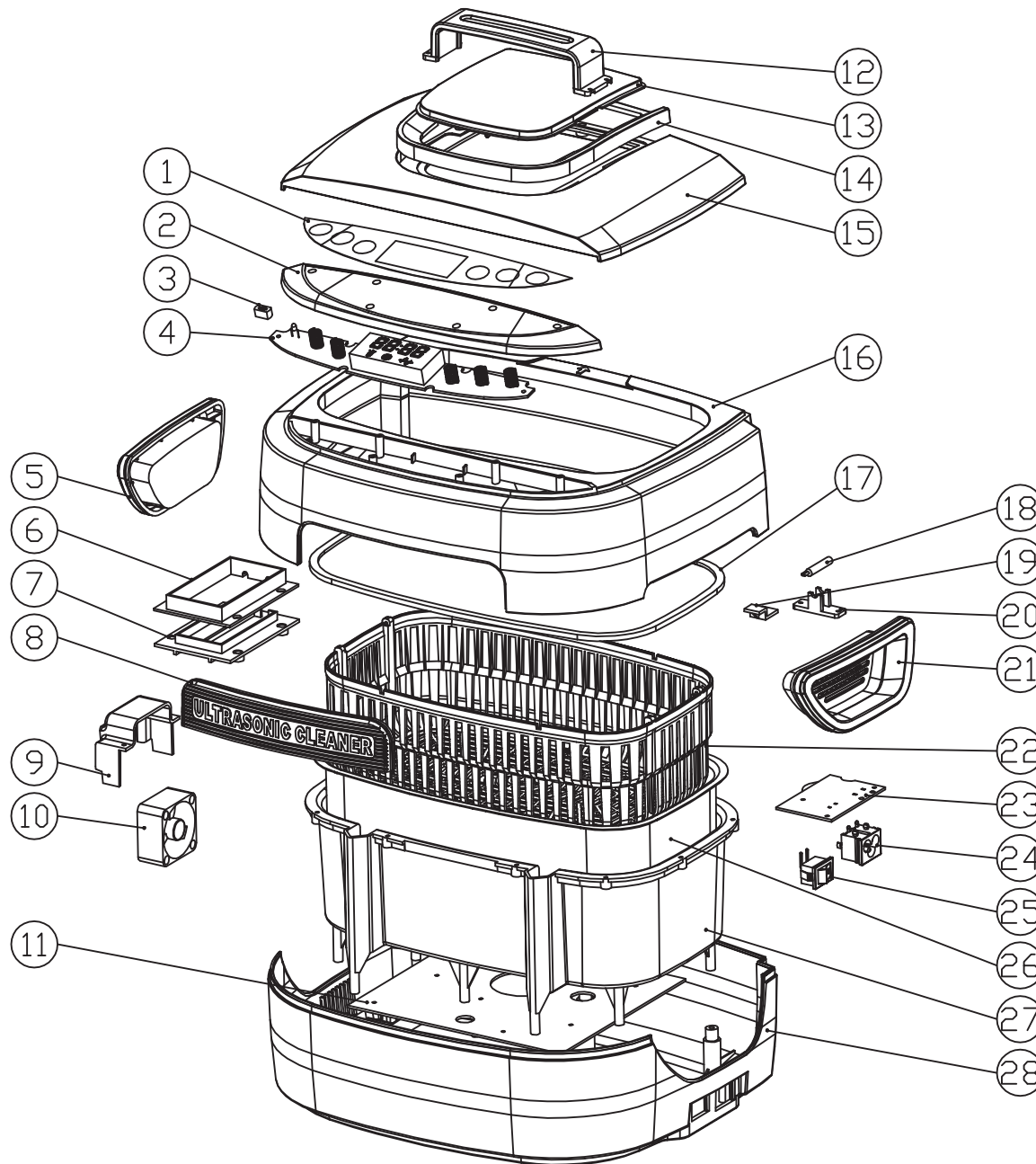

No.	Item	Material
①	Panel surface	PC
②	Control panel box	ABS
③	Light socket	ABS
④	Button pad	94V0
⑤	Left handle	ABS
⑥	Heater pocket	PA 66
⑦	Heater cover	PA 66
⑧	Logo block	ABS
⑨	Cooling fan socket	ABS
⑩	Cooling fan	Standard part
⑪	Power PCB	94V0
⑫	Stainless steel handle	SUS 304
⑬	Lid-window	AS
⑭	Lid top holderwindow bracket	ABS
⑮	Lid	ABS
⑯	Top housing	ABS
⑰	Silicon seal	Silicone rubber
⑱	Thermocouple	Standard part
⑲	Thermal cutoff holder	ABS
⑳	Thermocouple holder	ABS
㉑	Right handle	ABS
㉒	Plastic basket	ABS
㉓	Power switch	94V0
㉔	Power socket	Standard part
㉕	Power switch	Standard part
㉖	Stainless steel tank	SUS 304
㉗	Inner tank	ABS
㉘	Bottom housing	ABS

## SPECIFICATIONS

<b>Description</b>	TPC Ultrasonic Cleaner	
<b>Model</b>	UC 300	
<b>Tank Capacity</b>	3000 ml / 3.2 quart (US)	Max. 2500 ml / 2.6 quart (US)
		Min. 1500 ml / 1.6 quart (US)
<b>Tank Size</b>	25.0 x 17.4 x 7.8 cm / 9.8" x 6.9" x 3.1"	
<b>Longest Item Fits inside Tank</b>	26.6 cm / 10.5"	
<b>Power Supply</b>	170 W ( AC 100~120V 50/60Hz)	
	170 W (AC 220~240V 50/60Hz)	
	150 W (AC 100V 50/60Hz)	
<b>Digital Timer Settings</b>	1 to 30-minute full range timer	
<b>Drainage</b>	Drainage valve	
<b>Ultrasonic Frequency</b>	35,000 Hz	
<b>Tank Material</b>	Stainless Steel SUS304	
<b>Housing Material</b>	ABS	
<b>Net Weight</b>	5.1 kg / 11.3 lb	
<b>Gross Weight</b>	6.1 kg / 13.4 lb	
<b>Unit Size</b>	45.5 x 27.5 x 21.0 cm / 17.9" x 10.8" x 8.3"	
<b>Inner Carton Size</b>	49.0 x 31.5 x 28cm / 19.3" x 12.4" x 11"	
<b>Qty per Master Carton</b>	2 pcs /ctn	
<b>Master Carton Size</b>	50.5 x 33 x60 cm / 19.9" x 13" x23.6"	

# TPC Ultrasonic Cleaner

Dentsonic UC 300

## USER MANUAL

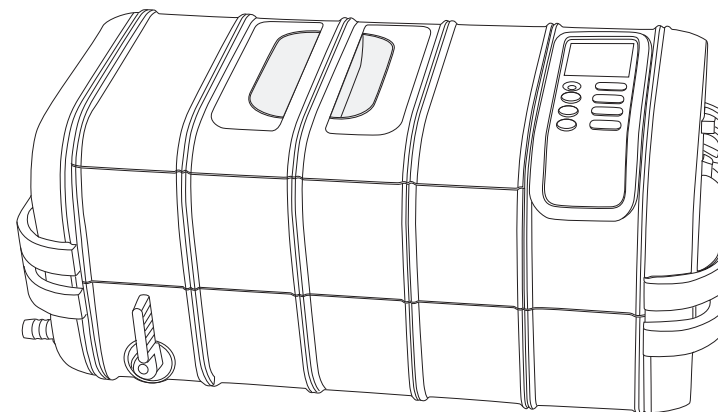

### FEATURES

- 1 Large capacity tank** Tank capacity 3000 ml / 3.2 qt;  
Tank size 25.0x17.4x7.8 cm / 9.8"x6.9"x3.1"
- 2 3-color LED display** 1 to 30-minute full range timer, 5 temperature settings, actual temperature thermometer, degas and solution usage timer
- 3 Drainage valve** Convenient to use
- 4 Super-sized ultrasonic transducer** Ø 45mm industrial grade transducer(80W), 30% more powerful than our standard transducer
- 5 Ceramic heaters** 100W ceramic heaters
- 6 Multiple circuit protectors** When overloaded or improperly used, the protectors shut down the power to certain areas to protect the machine
- 7 Two cooling fans** Improves heat dissipation and beneficial for continuous operations
- 8 PCB board placed vertically** Better water-proof
- 9 De-gas feature** Removes air bubbles quickly, fasten the fusion of water and solution
- 10 Moisture-proofed PCB with industrial IC** Capable for different working environments with better anti-interference performance
- 11 Detachable power cord** Independent power switch and detachable power cord, convenient to use
- 12 Engineering grade plastics** 4.5mm wall thickness with tongue and groove joints, with impact and water-proof performances

# INTRODUCTION

**Use tap water. Special solutions are not necessary in most cases.**

## **Principles of ultrasonic cleaning:**

Millions of tiny air bubbles are generated within liquid by high frequency vibration. The air bubbles burst when in contact with object and dislodge the debris to achieve the cleaning effect.



- Using tap water is sufficient. Purified water or distilled water has the same cleaning effect as regular tap water for ultrasonic cleaning.
- When cleaning silver or copper items where oxidation has darkened the items, special solutions needs to be added to the water to remove the oxidation.

## **Main Features**

- Tank opening size: 25.0 x 17.4 x 7.8 cm / 9.8" x 6.9" x 3.1". Longest item that can fit inside the tank is 26.6 cm / 10.5". 3000 ml / 3.2 qt tank capacity.
- Super-sized Ø45mm industrial grade ultrasonic cleaner ( 80 W) and two ceramic heater 100 W.
- 3-color LED display. 1 to 30-minute full range timer. 5 temperature settings. Solution usage timer. Working status indicators. Degas feature.
- Multiple circuit protections:
  - a. Thermal cutoff to prevent working without water.
  - b. Temperature controller to prevent PCB overheat.
  - c. Heater with internal timer to prevent overheating.
- Industrial grade IC. Moisture-proofed PCB. Two cooling fans working together.
- Drainage valve.

## **Read the Manual First**

The manual should be carefully reviewed before starting to use the device. Warnings should be observed carefully. Please follow the manual for operations.

# TABLE OF CONTENTS

Safety Precautions .....	1,2
Items Not Suitable for Ultrasonic Cleaning .....	2
Applications .....	3,4,5
Sample Applications .....	5,6
Product Structure and Accessories .....	7
Product Explosion Picture.....	8,9
Control Panel and Operations .....	10,11
Common Cleaning Methods .....	11,12,13
Operation Guidelines .....	14,15
Care and Maintenance .....	16



## CARE AND MAINTENANCE

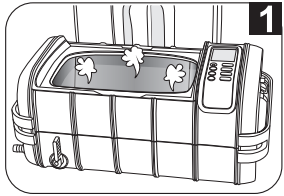

- 1 Do not turn on the unit without water in the tank.** Even though the unit is designed with multiple protections, if it is turned on for over 30 seconds without water in the tank, it may damage the unit or severely reduce the life of the unit. If heating over 3 minutes, it will damage the heater.

 This unit is equipped with a thermal cutoff. If the cleaning function is turned on without water in the tank, the temperature will rise continuously. The thermal cutoff will be actuated after approximately 15 minutes respectively to ensure safety. The unit will be disabled until it's repaired.

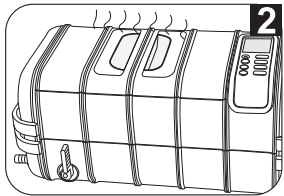

- 2 Do not run the unit for extended time or continuously.** The unit is designed with overheat protection. If the unit has been running for 45 minutes, it is recommended to stop the unit for about 20 minutes to prolong the life of the unit.

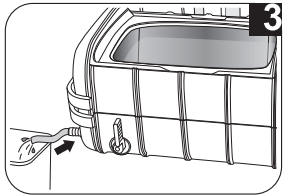

- 3 Do not keep water in the cleaning tank for a long time.** After cleaning is completed, open the drainage valve to drain the dirty water. Clean and wipe the tank dry.

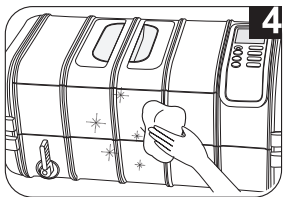

- 4 Do not spray water over the housing.** Use a towel to wipe the tank and the housing dry.

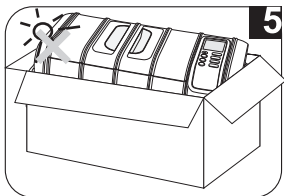

- 5 Do not expose the unit under direct sunshine for a long time.** Keep the unit in a dry, cool and ventilated area.

## SAFETY PRECAUTIONS



**Keep it away from children!**

-  **This appliance can be used by children aged from 8 years and above if they have been given supervision or instruction concerning use of the appliance in a safe way and if they understand the hazards involved. Cleaning and user maintenance shall not be made by children unless they are aged from 8 years and above and supervised. Keep the appliance and its cord out of reach of children aged less than 8 years.**
- Please store the ultrasonic cleaner where it is not reachable by children.
- Danger to children! Danger for death through suffocation! Keep the packaging material away from children.
- This appliance shall not be used by children. Keep the appliance and its cord out of reach of children.



**To prevent life-threatening electrical shock, please observe the following:**



**Danger of electrical shock!** Do not use while bathing. Never immerse the device or the power cord in water or other liquid.

- **Danger of electrical shock!** Never touch the power plug with wet hands, especially when inserting or removing the plug.
- **Danger of electrical shock!** If the unit has fallen into water during operation, do not touch the unit. Remove the power plug from the socket first.
- **Danger of electrical shock!** Do not spray water or liquid over the device.
- Never operate the device unattended.
- Follow the manual to operate the device.
- Do not use components unapproved by the manufacturer.
- When removing the power cord from the socket, grab the power plug not the cord.
- To protect the power cord from damage, do not cause it to get caught by things such as a cupboard door or a chair leg; do not drag across a hot surface.
- If there is damage to the power plug, cord, housing, or other parts of the device, do not use the device.
- Do not disassemble the device, except by professionals.
- If the unit is damaged, non-operational or has fallen into water, take it to a qualified service provider.
- Remove the power plug from the socket
  - if malfunction occurs
  - before cleaning the device
  - if the device is not going to be used for prolonged period
  - after each use (recommended)
- The installation of an earth leakage circuit breaker with a rated tripping current of no more than 30 mA provides further protection against an electrical shock. The installation should only be carried out by a trained electrician.



**To prevent fire hazards, please observe the following:**

- Never block the vents on the device. Keep the vents free from lint, hair and other materials.
- Do not place the device on a soft surface, such as a bed or a couch, where the vents could be blocked.
- Observe the other warnings in the previous section.
- If the supply cord is damaged, it must be replaced by the manufacturer or its service agent or a similarly qualified person in order to avoid a hazard.

## SAFETY PRECAUTIONS



### Other observations:

- Do not operate the product without filling the tank with water. Running dry will damage the unit.
- Do not plug in the power cord before adding water to the tank. Do not fill the tank above the Max line to avoid overspill.
- Do not use solution containing abrasive substances or strong corrosive chemical solution not recommended by the manufacturer or the supplier.
- Place the device on a dry and flat surface for operation.
- When the device is subjected to severe electromagnetic interference, it may malfunction, stop operating or lose control functions. If this happens, unplug the power cord then reinsert it to restart the device.

## IMPORTANT SAFETY INSTRUCTIONS



### When using electric appliances, basic precautions should always be followed, including the following :



- Read all the instructions before using the appliance.
- To reduce the risk of injury, close supervision is necessary when an appliance is used near children.
- Only use attachments recommended or sold by the manufacturer.
- Do not use outdoors.
- To disconnect, turn all controls to the off (O) position, then remove plug from outlet. Do not unplug by pulling on cord. To unplug, grasp the plug, not the cord. Unplug from outlet when not in use and before servicing or cleaning.
- To reduce the risk of electrical shock, do not put the appliance in water or other liquid. Do not place or store appliance where it can fall or be pulled into a tub or sink.
- All servicing of this product, including transducer replacement, is to be conducted by qualified service personnel.
- Do not operate any appliance with a damaged cord or plug, or after the appliance malfunctions or is dropped or damaged in any manner. Return appliance to the nearest authorized service facility for examination, repair, or electrical or mechanical adjustment.

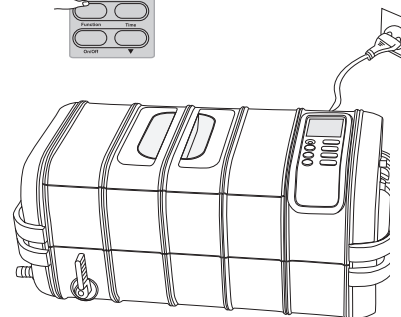
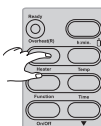

### Items Not Suitable for Ultrasonic Cleaning

<b>Soft Jewelry:</b> Pearls, emerald, ivory, coral, agate, sea turtle shells, etc	These items are not hard, so scratches may occur during cleaning.
<b>Welded, Plated and Glued Items:</b> Welded or plated metal items, glued items	Ultrasonic cleaning may enlarge the gaps inside the welded joints, plated coating or glued items and may cause separation.
<b>Watches:</b> Except diver's watches with depth rating over 50 m (150 ft) .	Because the strong penetration capability of the ultrasonic waves, water may get into the watches if they are not truly waterproof. Use the watch stand supplied as a precaution if not sure.
<b>Others:</b> Wood; coated glass, ceramic, camera filters with preexisting cracks.	Ultrasonic cleaning may enlarge the cracks pre-existed in the coating on the glasses, ceramic, and glass. If the items have no pre-existing cracks, then it is okay.



- 4** Select one of the four cleaning methods recommended earlier.
- a.** When the heater is needed, press TEMP button to select one of the 5 preset temperatures. Press Heater button,  flashes, indicating the heater is turned on. When the water reaches the set temperature,  dims, indicating the heater is turned off.

To ensure safety, the unit is designed with dual protections. The heater will be turned off automatically if it has been running for 50 minutes.

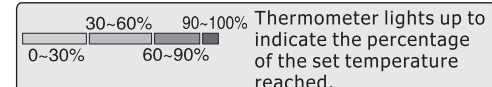

- b.** If solution is added, to speed up the mixing and to use less solution, use degas function. Press TIME button to set the timer to 10 minutes then press Function button,  illuminates. Press On/Off to start degassing. It changes over to normal cleaning automatically after 90 seconds.
- c.** When debris "smoke" is no longer visible, cleaning is done. If additional cleaning is needed, reset the timer and repeat the steps above.

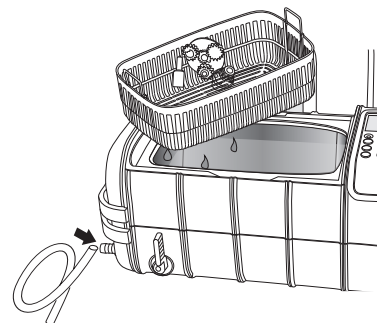

- 5** When cleaning is completed, switch off the power, open the lid and retrieve the basket and the items. Alternatively, raise and suspend the basket above water as illustrated in the Usage Guide for Accessories section to drain water. Connect the hose to the drainage pipe as shown. Open the drainage valve to drain the dirty water. Clean and wipe the tank dry. Close the drainage valve.

## OPERATION GUIDELINES

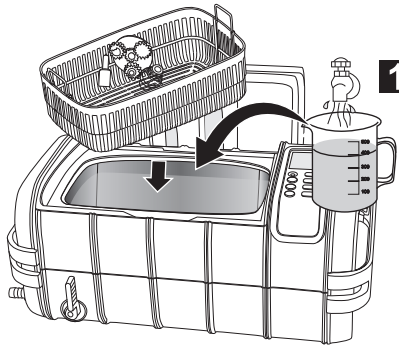

- 1** Remove the cover and put it on the cover holder vertically. Put items in the basket then put them in the cleaning tank. Add water to a level between MIN and MAX and above the area to be cleaned.

 If the unit is turned on without water, ultrasonic energy will not be absorbed. This model also has high power. Once on for over 15 seconds, it may damage the unit or severely reduce the life of the unit.

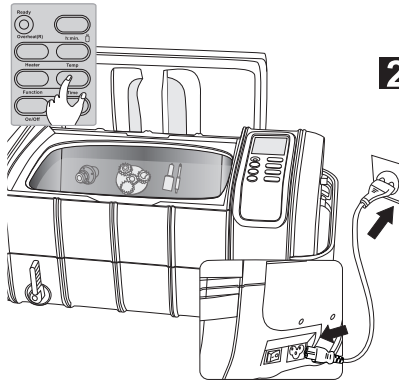

- 2** Connect the power cord to an outlet and turn the switch on. LED display shows 5:00. This is the most common timer setting and working state. If the timer needs to be adjusted, press Time button and ▼ button. The timer can be set between 1 to 30 minutes. Common cleaning times are 5, 10 or 15 minutes.

Prolonged cleaning time may result in:  
a. Loosening of the screws if used.  
b. Increasing pre-existing cracks.  
c. Peeling of coating which was already separated.

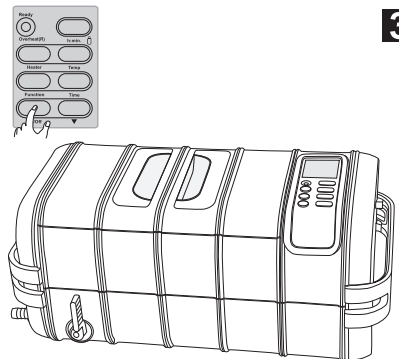

- 3** Press On/Off button to start cleaning. During cleaning, buzzing sound can be heard from the cleaning tank, indicating that the cleaning is underway. Closing the lid will reduce the noise level. The digital timer will count down to show the remaining cleaning time. When it displays 00:00, the cleaning is done. To stop cleaning at any time, press On/Off button. The unit is designed with overheating protection to avoid extended and continuous operation for too long. When the red light is on, the unit will not turn on even if it is forced to. The unit will be idled for about 20 minutes and can be restarted after the green light comes on.

**13. On/Off Button.** After powering on, the LED displays which is the default time(as picture shown), and the unit is ready with the normal working status. Press On/Off button once and the cleaning starts. The cleaning stops when the timer counts down to 00:00. If the unit needs to be stopped before the timer runs out, press On/Off button.



**14. 0 h/min – Solution Usage Timer Set Button.** Each time that 0 button is pressed, the timer is increased by 20 minutes. For example, 1:20 indicate that the solution is set to be used for 1 hour and 20 minutes. The maximum time can be set is 9 hour 60 minutes.

**15. Temperature Set Button.** 5 set temperatures (°C/°F) can be selected. Press Temp button to select the temperature in the following sequence:  
→ 40°C or 104°F → 45°C or 113°F → 50°C or 122°F → 55°C or 131°F → 60°C or 140°F →

**16. Timer Quick Set Button.** Press Time button, LED display shows 05:00. Each pressing increases the time by 5 minutes.

**17. ▼ - Decreasing Button.**

- a. When Time is used, each pressing reduces the timer by 1 minute.
- b. When Temp is used, each pressing reduces the set temperature down to the next level.
- c. When 0 h/min is used, each pressing reduces the solution set time by 20 minutes.

## CONTROL PANEL AND OPERATIONS

- 05:00 – Working Time Display.** It counts down after work is started.
- Multistage Thermometer.** Solid green light indicates that the water temperature is 0-30% of the set temperature. Solid orange light indicates that the water temperature is 30-60% of the set temperature. Solid red light indicates that the water temperature is 60-90% of the set temperature. Flashing red light indicates that the water temperature is close to the set temperature. All lights indicate that the water temperature is at the set temperature (90-100%).
- 050 – Set Temperature Display.** Press Temp button to select one of the 5 set temperatures.   
→ 40°C or 104°F → 45°C or 113°F → 50°C or 122°F → 55°C or 131°F → 60°C or 140°F
- CF – °C or °F Indicator.**   
°C – Set temperature in °C.   
°F – Set temperature in °F.
- 1:40 – Solution usage remaining time.** It counts down to show the remaining usage time (hour:minute) of the solution.
- Solution Warning Light.** Once the Solution Usage Timer is set, the light will come up. flashing, indicates that solution needs to be changed.
- Degas Status.** – Illuminated, the degas function is selected. Flashing, degassing is underway.
- Normal Cleaning Status.** – Illuminated, normal cleaning is underway.
- Heater Status.** Press Heater button, flashes, indicating the heater is turned on. Press Heater button again, dims, indicating the heater is turned off.
- Working status.**   
Green – Ready (G): Normal working status, ready to use.   
Red – Overheat (R): Under overheat protection. 20 minutes or more of waiting time is needed for the light to change from red to green. Work can resume afterwards.
- Heater button.** Pressing Heater button, flashes, indicating the heater is turned on. To cancel heating, press Heater button again, dims, indicating the heater is turned off.

When the water reaches the set temperature, the heater will turn off automatically.

- Function Button.** Press Function button, illuminates, indicating Degas function is selected. Press On/Off button to start degassing. will flash for 2 minutes, then the unit will return to the normal cleaning function. Pressing Function button before it ends will stop degassing. If additional degassing is needed after it ends, press Function button again.

**Degas:** When cleaning heavily soiled or greasy items or silver, copper or brass items, chemical solutions need to be added into the water. The solution may form many small droplets and take a long time to dissolve in the water. Newly added water may generate many air bubbles on the tank walls. These will reduce the cleaning effect in the beginning phase of ultrasonic cleaning. Turning on the degas function will dissipate the droplets and the air bubbles, usually in 2 minutes, and improve cleaning efficiency.

## PRODUCT STRUCTURE AND ACCESSORIES

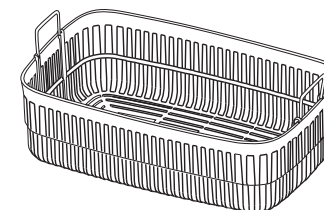
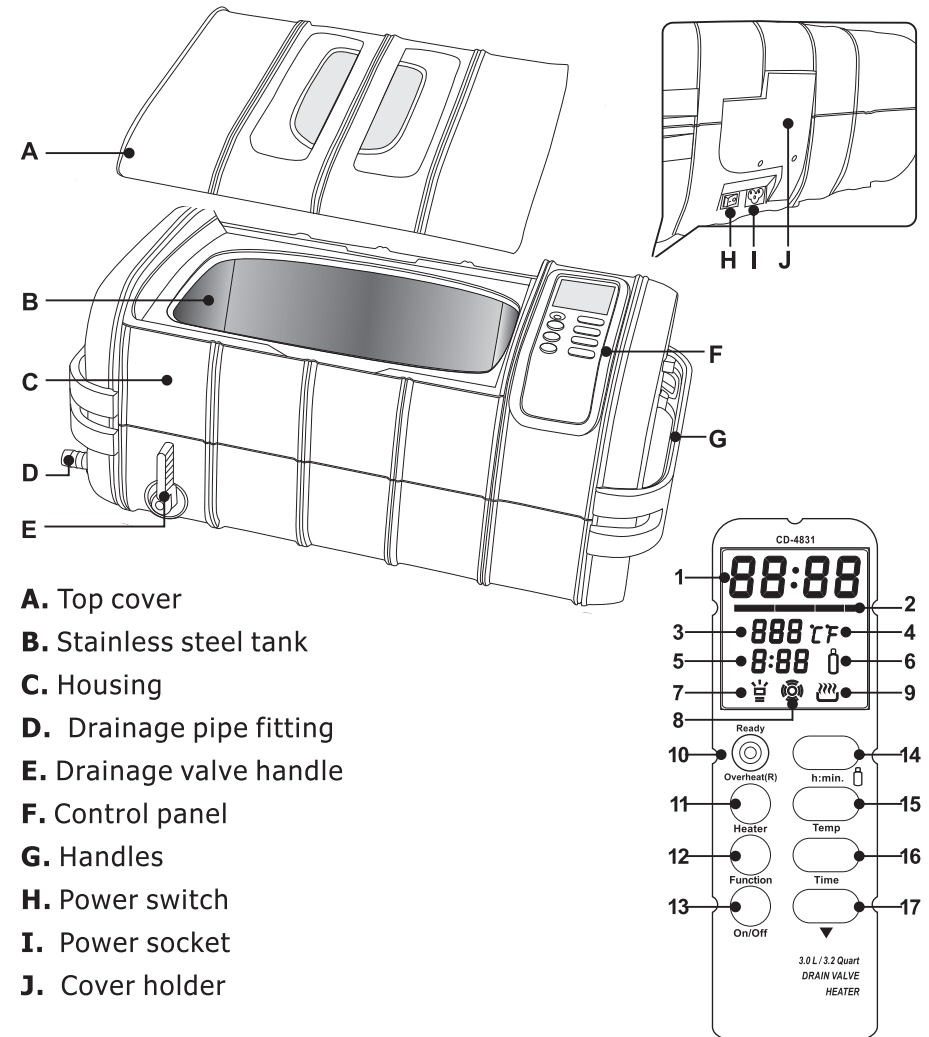

Plastic basket



Power cord

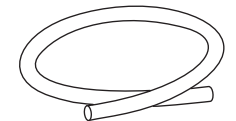

Hose



# PRODUCT EXPLOSION PICTURE

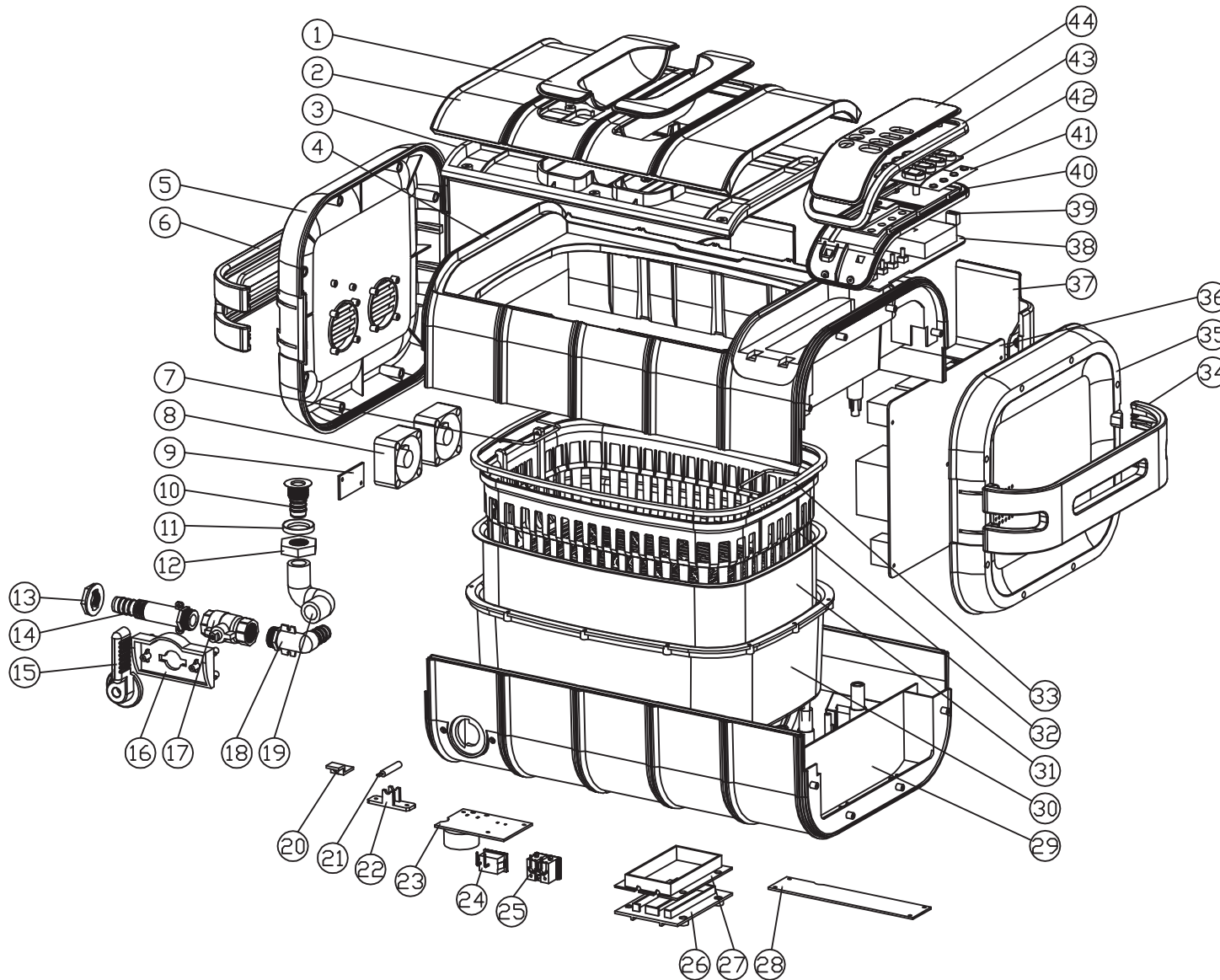

No.	Item	Material
①	Lid-window	AS
②	Lid-top	ABS
③	Lid-bottom	ABS
④	Top ring	ABS
⑤	Left cover	ABS
⑥	Left handle	ABS
⑦	Stainless steel handle	Stainless steel 304
⑧	Cooling fan	Standard part
⑨	Socket board for conversion	94V0
⑩	Spout	SUS 304
⑪	Washer	AL
⑫	Nut	AC
⑬	Nut	ABS
⑭	Spout	ABS
⑮	Valve handle	ABS
⑯	Bracket	ABS
⑰	Ball valve	Standard part
⑱	Elbow	ABS
⑲	Hose	Silicone rubber
⑳	Thermal cutoff holder	ABS
㉑	Thermocouple	Standard part
㉒	Thermocouple holder	ABS
㉓	Power switch PCB	94V0
㉔	Power switch	Standard part
㉕	Power socket	Standard part
㉖	Heater cover	PA 66+30% fiberglass
㉗	Heater pocket	PA 66+30% fiberglass
㉘	Power PCB 2	94V0
㉙	Bottom housing	ABS
㉚	Inner tank	ABS
㉛	Stainless steel tank	Stainless steel 304
㉜	Plastic basket	ABS
㉝	Silicon seal	Silicone rubber
㉞	Right handle	ABS
㉟	Right cover	ABS
㊱	Power PCB 1	94V0
㊲	Cover holder	ABS
㊳	Button pad	94V0
㊴	Light socket	ABS
㊵	Keypad cover	ABS
㊶	Film	PC
㊷	Soft rubber button	TRP 40°
㊸	Control panel up cover	ABS
㊹	Keypad lens	AS

# SPECIFICATIONS

<b>Description</b>	TPC Ultrasonic Cleaner	
<b>Model</b>	UC 600	
<b>Tank Capacity</b>	6.0 L / 1.6 gallon (US)	Max. 5.0 L / 1.3 gallon (US)
		Min. 3.35 L / 0.9 gallon (US)
<b>Tank Size</b>	32.3 x 20.5 x 9.9 cm / 12.7" x 8.1" x 3.9"	
<b>Longest Item Fits inside Tank</b>	34.0 cm / 13.4"	
<b>Power Supply</b>	260 W ( AC 100~120V 50/60Hz)	
	300 W (AC 220~240V 50/60Hz)	
	250 W (AC 100V 50/60Hz)	
<b>Digital Timer Settings</b>	1 to 30-minute full range timer	
<b>Drainage</b>	Drainage valve	
<b>Ultrasonic Frequency</b>	35,000 Hz	
<b>Tank Material</b>	Stainless Steel SUS304	
<b>Housing Material</b>	ABS	
<b>Net Weight</b>	7.9 kg / 17.4 lb	
<b>Gross Weight</b>	9.0 kg / 19.8 lb	
<b>Unit Size</b>	53.4 x 30.5 x 24.4 cm / 21.0" x 12.0" x 9.6"	
<b>Inner Carton Size</b>	57.5 x 37.0 x 32.5 cm / 22.6" x 14.6" x 12.8"	
<b>Qty per Master Carton</b>	2 pcs /ctn	
<b>Master Carton Size</b>	60.0 x 38.5 x 67.0 cm / 23.6" x 15.2" x 26.4"	

# TPC Ultrasonic Cleaner

Dentsonic UC 600

## USER MANUAL

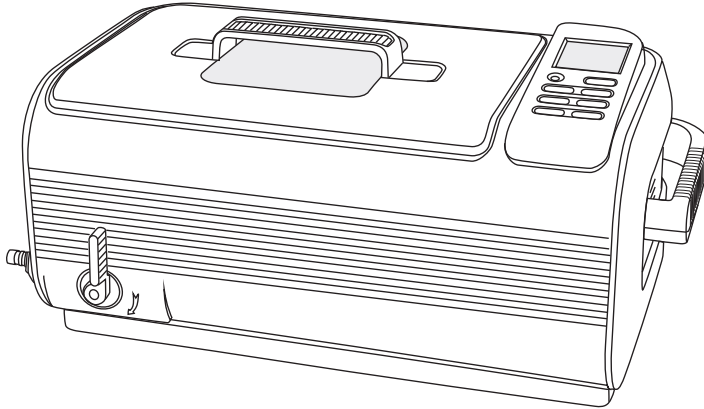

### FEATURES

**1 Large capacity tank**

Tank capacity 6.0 L / 1.6 gallon;  
Tank size 32.5x20.5x9.9 cm / 12.8"x8.1"x3.9"

**2 Suspendible basket**

Patented design, basket can be raised and suspended to drain water

**3 Drainage valve**

Convenient to use

**4 Two industrial grade ultrasonic transducers**

Uniform distribution of ultrasonic waves, strong cleaning, high durability

**5 Two ceramic heaters**

Mounted underneath the bottom of the tank for safe and even heating; more durability construction

**6 3-color LED display**

1 to 30-minute full range timer, 5 temperature settings, actual temperature thermometer, degas and solution usage timer

**7 Independent control circuit for each ultrasonic transducer**

40% higher efficiency, not susceptible to interference, more durable

**8 Multiple circuit protectors**

When overloaded or improperly used, the protectors shut down the power to certain areas to protect the machine

**9 Moisture-proofed PCB with industrial IC**

Capable for different working environments with better anti-interference performance

**10 Two cooling fans**

One for cooling of PCB boards, one for cooling of ultrasonic transducers. Improve heat dissipation and beneficial for continuous operations

**11 De-gas feature**

Removes air bubbles quickly

**12 Engineering grade plastics**

Better water-proof and drop-proof properties

# INTRODUCTION

**Use tap water. Special solutions are not necessary in most cases.**

## **Principles of ultrasonic cleaning:**

Millions of tiny air bubbles are generated within liquid by high frequency vibration. The air bubbles burst when in contact with object and dislodge the debris to achieve the cleaning effect.



- Using tap water is sufficient. Purified water or distilled water has the same cleaning effect as regular tap water for ultrasonic cleaning.
- When cleaning silver or copper items where oxidation has darkened the items, special solutions needs to be added to the water to remove the oxidation.

## **Main Features**

- Tank opening 32.5 x 20.5 x 9.9 cm / 12.8" x 8.1" x 3.9". Longest item that can fit inside the tank is 34.0 cm / 13.4". 6.0 L / 1.6 gallon tank capacity.
- Suspendible basker to drain water conveniently.
- 2 industrial grade ultrasonic transducers (approximately 2 x 55 W = 110 W), 2 ceramic heaters (approximately 2 x 80 W = 160 W).
- 3-color LED display. 1 to 30-minute full range timer. 5 temperature settings. Actual temperature thermometer. Solution usage timer. Working status indicators. Degas feature.
- Independent control circuits and multiple circuit protections.
- Industrial grade IC. Moisture-proofed PCB. Cooling fan. Drainage valve.

## **Read the Manual First**

The manual should be carefully reviewed before starting to use the device. Warnings should be observed carefully. Please follow the manual for operations.

# TABLE OF CONTENTS

Safety Precautions .....	1,2
Items Not Suitable for Ultrasonic Cleaning .....	2
Applications .....	3,4,5
Sample Applications .....	5,6
Product Structure and Accessories .....	7
Product Explosion Picture.....	8,9
Control Panel and Operations .....	10,11
Common Cleaning Methods .....	11,12,13
Operation Guidelines .....	14,15
Care and Maintenance .....	16
Usage Guide for Accessories.....	17

# SAFETY PRECAUTIONS



## Keep it away from children!

-  **This appliance can be used by children aged from 8 years and above if they have been given supervision or instruction concerning use of the appliance in a safe way and if they understand the hazards involved. Cleaning and user maintenance shall not be made by children unless they are aged from 8 years and above and supervised. Keep the appliance and its cord out of reach of children aged less than 8 years.**
- Please store the ultrasonic cleaner where it is not reachable by children.
- Danger to children! Danger for death through suffocation! Keep the packaging material away from children.
- This appliance shall not be used by children. Keep the appliance and its cord out of reach of children.



## To prevent life-threatening electrical shock, please observe the following:



**Danger of electrical shock!** Do not use while bathing. Never immerse the device or the power cord in water or other liquid.

- **Danger of electrical shock!** Never touch the power plug with wet hands, especially when inserting or removing the plug.
- **Danger of electrical shock!** If the unit has fallen into water during operation, do not touch the unit. Remove the power plug from the socket first.
- **Danger of electrical shock!** Do not spray water or liquid over the device.
- Never operate the device unattended.
- Follow the manual to operate the device.
- Do not use components unapproved by the manufacturer.
- When removing the power cord from the socket, grab the power plug not the cord.
- To protect the power cord from damage, do not cause it to get caught by things such as a cupboard door or a chair leg; do not drag across a hot surface.
- If there is damage to the power plug, cord, housing, or other parts of the device, do not use the device.
- Do not disassemble the device, except by professionals.
- If the unit is damaged, non-operational or has fallen into water, take it to a qualified service provider.
- Remove the power plug from the socket
  - if malfunction occurs
  - before cleaning the device
  - if the device is not going to be used for prolonged period
  - after each use (recommended)
- The installation of an earth leakage circuit breaker with a rated tripping current of no more than 30 mA provides further protection against an electrical shock. The installation should only be carried out by a trained electrician.



## To prevent fire hazards, please observe the following:

- Never block the vents on the device. Keep the vents free from lint, hair and other materials.
- Do not place the device on a soft surface, such as a bed or a couch, where the vents could be blocked.
- Observe the other warnings in the previous section.
- If the supply cord is damaged, it must be replaced by the manufacturer or its service agent or a similarly qualified person in order to avoid a hazard.



# SAFETY PRECAUTIONS



## Other observations:

- Do not operate the product without filling the tank with water. Running dry will damage the unit.
- Do not plug in the power cord before adding water to the tank. Do not fill the tank above the Max line to avoid overspill.
- Do not use solution containing abrasive substances or strong corrosive chemical solution not recommended by the manufacturer or the supplier.
- Place the device on a dry and flat surface for operation.
- When the device is subjected to severe electromagnetic interference, it may malfunction, stop operating or lose control functions. If this happens, unplug the power cord then reinsert it to restart the device.

# IMPORTANT SAFETY INSTRUCTIONS



## When using electric appliances, basic precautions should always be followed, including the following :

- Read all the instructions before using the appliance.
- To reduce the risk of injury, close supervision is necessary when an appliance is used near children.
- Only use attachments recommended or sold by the manufacturer.
- Do not use outdoors.
- To disconnect, turn all controls to the off (O) position, then remove plug from outlet. Do not unplug by pulling on cord. To unplug, grasp the plug, not the cord. Unplug from outlet when not in use and before servicing or cleaning.
- To reduce the risk of electrical shock, do not put the appliance in water or other liquid. Do not place or store appliance where it can fall or be pulled into a tub or sink.
- All servicing of this product, including transducer replacement, is to be conducted by qualified service personnel.
- Do not operate any appliance with a damaged cord or plug, or after the appliance malfunctions or is dropped or damaged in any manner.  
Return appliance to the nearest authorized service facility for examination, repair, or electrical or mechanical adjustment.



## Items Not Suitable for Ultrasonic Cleaning

### Soft Jewelry:

Pearls, emerald, ivory, coral, agate, sea turtle shells, etc

These items are not hard, so scratches may occur during cleaning.

### Welded, Plated and Glued Items:

Welded or plated metal items, glued items

Ultrasonic cleaning may enlarge the gaps inside the welded joints, plated coating or glued items and may cause separation.

### Watches:

Except diver's watches with depth rating over 50 m (150 ft) .

Because the strong penetration capability of the ultrasonic waves, water may get into the watches if they are not truly waterproof. Use the watch stand supplied as a precaution if not sure.

### Others:

Wood; coated glass, ceramic, camera filters with preexisting cracks.

Ultrasonic cleaning may enlarge the cracks pre-existed in the coating on the glasses, ceramic, and glass. If the items have no pre-existing cracks, then it is okay.

# PRODUCT STRUCTURE AND ACCESSORIES

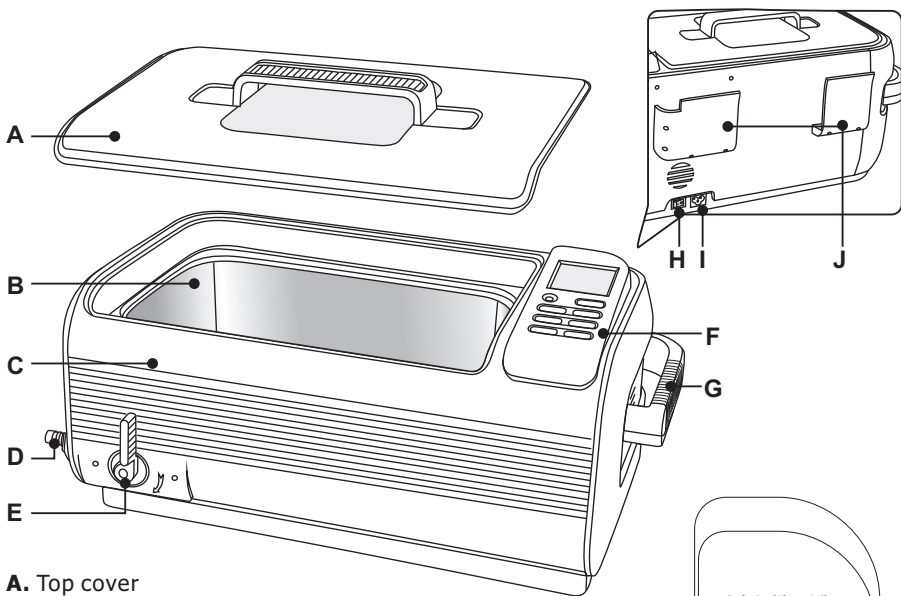

- A.** Top cover
- B.** Stainless steel tank
- C.** Housing
- D.** Drainage pipe fitting
- E.** Drainage valve handle
- F.** Control panel
- G.** Handles
- H.** Power switch
- I.** Power socket
- J.** Cover holder

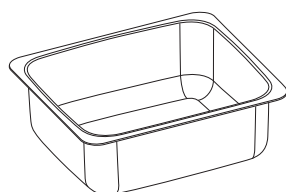

Optional Accessory: Indirect cleaning tank  
 Size: 21.7x18.5x7.4 cm    Capacity: 2.1 L  
 Internal size: 19.8x16.6x7.35 cm

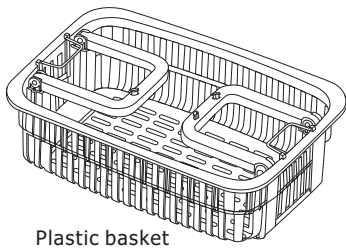
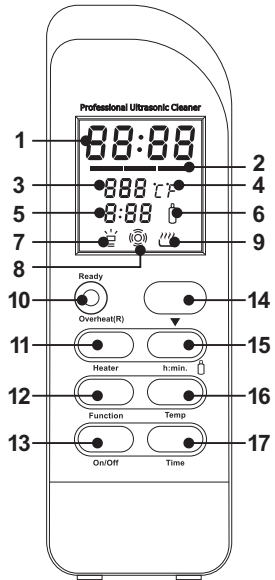

Plastic basket



Power cord

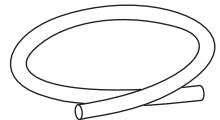

Hose



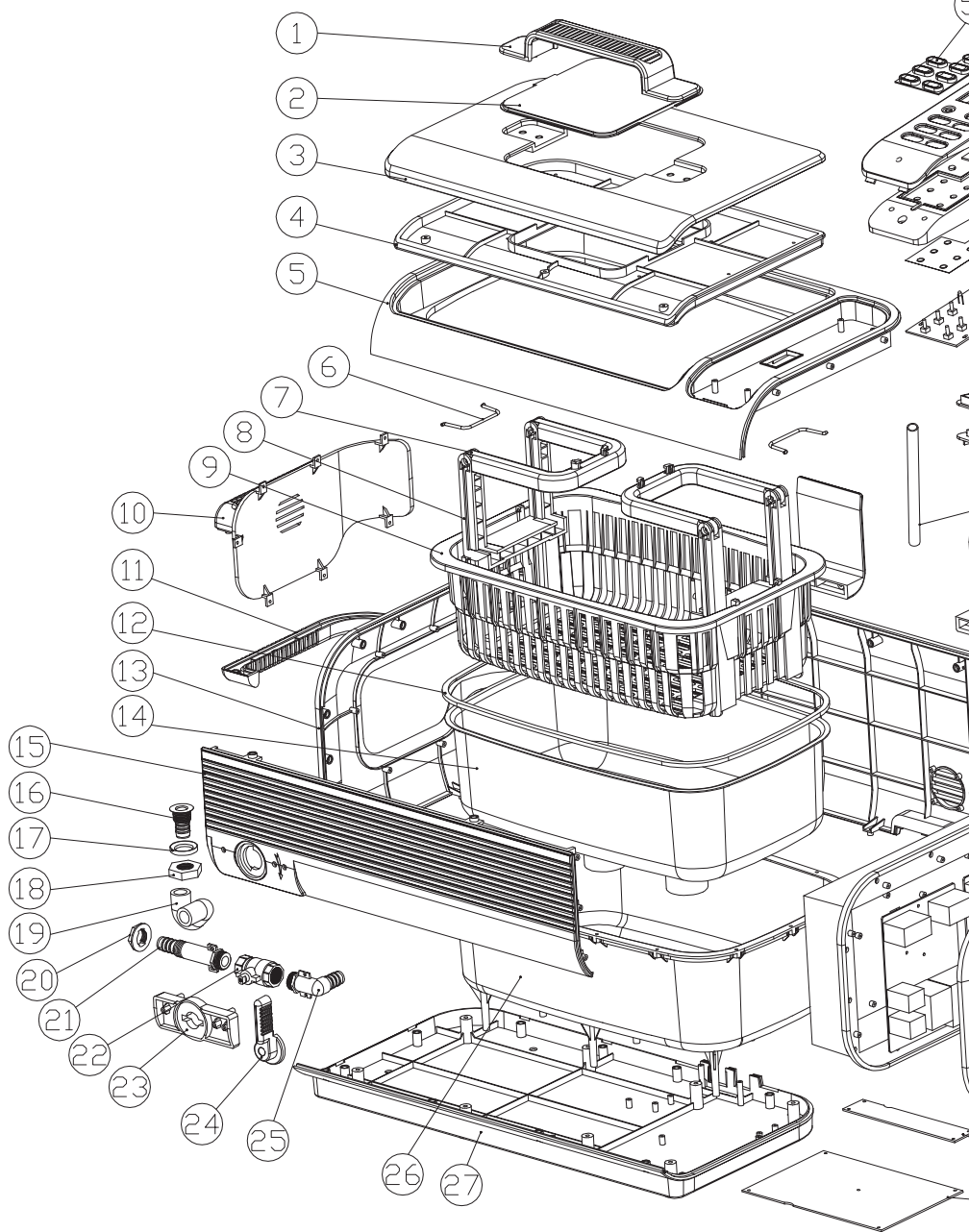

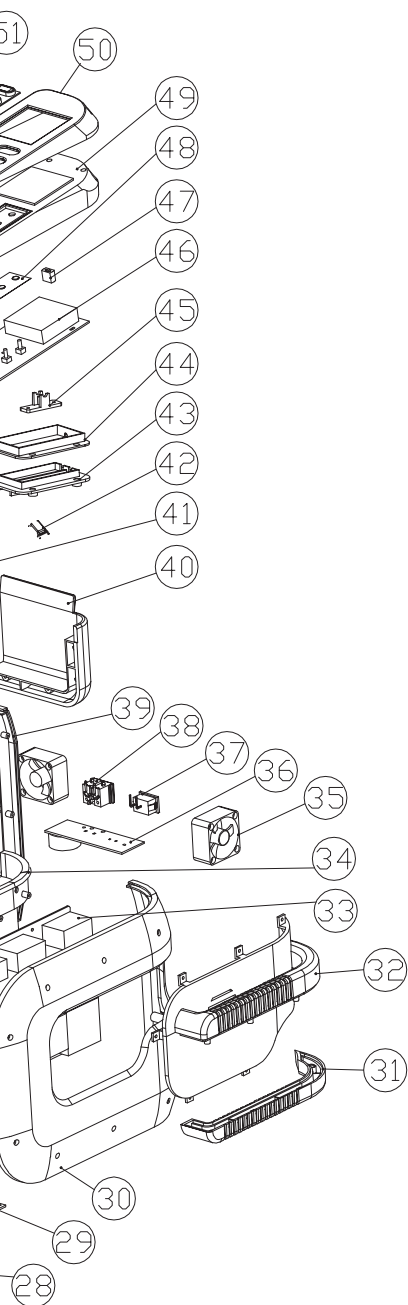







# PRODUCT EXPLOSION PICTURE







No.	Item	Material
①	Top handle	ABS
②	Lid-window	AS
③	Lid-top	ABS
④	Lid-bottom	ABS
⑤	Top ring	ABS
⑥	Stainless steel handle	SUS 304
⑦	Basket foldable handle 1	ABS
⑧	Basket foldable handle 2	ABS
⑨	Plastic basket	ABS
⑩	Left up handle	ABS
⑪	Left down handle	ABS
⑫	Silicon seal	Silicone rubber
⑬	Left cover	ABS
⑭	Stainless steel tank	SUS 304
⑮	Front cover	ABS
⑯	Spout	SUS 304
⑰	Washer	AL
⑱	Nut	AL
⑲	Hose	Silicone rubber
⑳	Nut	ABS
㉑	Spout	ABS
㉒	Ball valve	Standard part
㉓	Bracket	ABS
㉔	Valve handle	ABS
㉕	Elbow	ABS
㉖	Inner tank	ABS
㉗	Bottom cover	ABS
㉘	Power PCB 1	94V <sub>0</sub>
㉙	Power PCB 2	94V <sub>0</sub>
㉚	Right cover	ABS
㉛	Right down handle	ABS
㉜	Right up handle	ABS
㉝	Transducer PCB	94V <sub>0</sub>
㉞	Right panel	ABS
㉟	Cooling fan	Standard part
㊱	Power switch	94V <sub>0</sub>
㊲	Power switch	Standard part
㊳	Power socket	Standard part
㊴	Back cover	ABS
㊵	Cover holder	ABS
㊶	Hose	Silicone rubber
㊷	Thermal cutoff	A0-3A-F
㊸	Heater cover	PA 66
㊹	Heater pocket	PA 66
㊺	Thermocouple holder	ABS
㊻	Button pad	94V <sub>0</sub>
㊼	Light socket	ABS
㊽	Film	PC
㊾	Control panel box	AS
㊿	Control panel cover	ABS
51	Key pad cover	TRP 40°

# CONTROL PANEL AND OPERATIONS

- 05:00 – Working Time Display.** It counts down after work is started.
  - Multistage Thermometer.**  Solid green light indicates that the water temperature is 0-30% of the set temperature.  Solid orange light indicates that the water temperature is 30-60% of the set temperature.  Solid red light indicates that the water temperature is 60-90% of the set temperature.  Flashing red light indicates that the water temperature is close to the set temperature. All lights indicate that the water temperature is at the set temperature (90-100%).
  - 050 – Set Temperature Display.** Press Temp button to select one of the 5 set temperatures. → 40°C or 104°F → 45°C or 113°F → 50°C or 122°F → 55°C or 131°F → 60°C or 140°F →
  - CF – °C or °F Indicator.**  
°C – Set temperature in °C.  
°F – Set temperature in °F.
  - 1:40 – Solution usage remaining time.** It counts down to show the remaining usage time (hour:minute) of the solution.
  - Solution Warning Light.** Once the Solution Usage Timer is set, the light will come up.  flashing, indicates that solution needs to be changed.
  - Degas Status.**  — Illuminated, the degas function is selected.  Flashing, degassing is underway.
  - Normal Cleaning Status.**  — Illuminated, normal cleaning is underway.
  - Heater Status.** Press Heater button,  flashes, indicating the heater is turned on. Press Heater button again,  dims, indicating the heater is turned off.
- 10. Working status.**  
Green – Ready (G): Normal working status, ready to use.  
Red – Overheat (R): Under overheat protection. 20 minutes or more of waiting time is needed for the light to change from red to green. Work can resume afterwards.
- 11. Heater button.** Pressing Heater button,  flashes, indicating the heater is turned on. To cancel heating, press Heater button again,  dims, indicating the heater is turned off.

When the water reaches the set temperature, the heater will turn off automatically.

- 12. Function Button.** Press Function button,  illuminates, indicating Degas function is selected. Press On/Off button to start degassing.  will flash for 90 seconds, then the unit will return to the normal cleaning function. Pressing Function button before it ends will stop degassing. If additional degassing is needed after it ends, press Function button again.

**Degas:** When cleaning heavily soiled or greasy items or silver, copper or brass items, chemical solutions need to be added into the water. The solution may form many small droplets and take a long time to dissolve in the water. Newly added water may generate many air bubbles on the tank walls. These will reduce the cleaning effect in the beginning phase of ultrasonic cleaning. Turning on the degas function will dissipate the droplets and the air bubbles, usually in 90 seconds, and improve cleaning efficiency.



**13. On/Off Button.** After powering on, the LED displays which is the default time(as picture shown), and the unit is ready with the normal working status. Press On/Off button once and the cleaning starts. The cleaning stops when the timer counts down to 00:00. If the unit needs to be stopped before the timer runs out, press On/Off button.

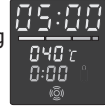

**14. ▼ - Decreasing Button.**

- a. When Time is used, each pressing reduces the timer by 1 minute.
- b. When Temp is used, each pressing reduces the set temperature down to the next level.
- c. When h/min is used, each pressing reduces the solution set time by 20 minutes.

**15. h/min – Solution Usage Timer Set Button.** Each time that h/min button is pressed, the timer is increased by 20 minutes. For example, 1:20 indicate that the solution is set to be used for 1 hour and 20 minutes. The maximum time can be set is 9 hour 60 minutes.

**16. Temperature Set Button.** 5 set temperatures (°C/°F) can be selected. Press Temp button to select the temperature in the following sequence:

→ 40°C or 104°F → 45°C or 113°F → 50°C or 122°F → 55°C or 131°F → 60°C or 140°F →

**17. Timer Quick Set Button.** Press Time button, LED display shows 05:00. Each pressing increases the time by 5 minutes.

# OPERATION GUIDELINES

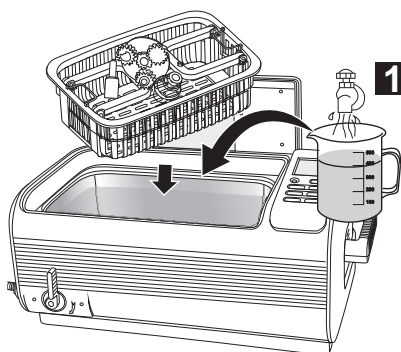

- 1** Remove the cover and put it on the cover holder vertically. Put items in the basket then put them in the cleaning tank. Add water to a level between MIN and MAX and above the area to be cleaned.

 If the unit is turned on without water, ultrasonic energy will not be absorbed. This model also has high power. Once on for over 15 seconds, it may damage the unit or severely reduce the life of the unit.

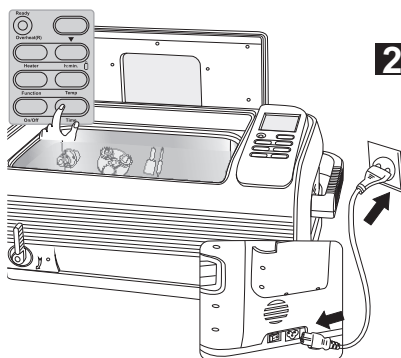

- 2** Connect the power cord to an outlet and turn the switch on. LED display shows 5:00. This is the most common timer setting and working state. If the timer needs to be adjusted, press Time button and ▼ button. The timer can be set between 1 to 30 minutes. Common cleaning times are 5, 10 or 15 minutes.

Prolonged cleaning time may result in:

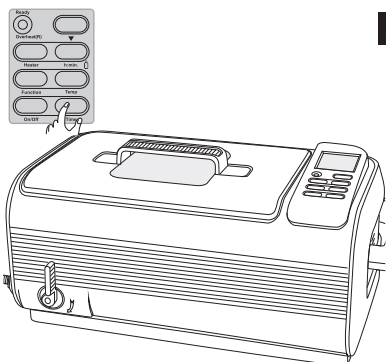

- a. Loosening of the screws if used.
- b. Increasing pre-existing cracks.
- c. Peeling of coating which was already separated.

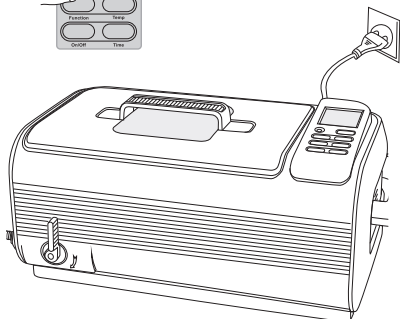
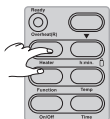

- 3** Press On/Off button to start cleaning. During cleaning, buzzing sound can be heard from the cleaning tank, indicating that the cleaning is underway. Closing the lid will reduce the noise level. The digital timer will count down to show the remaining cleaning time. When it displays 00:00, the cleaning is done. To stop cleaning at any time, press On/Off button. The unit is designed with overheating protection to avoid extended and continuous operation for too long. When the red light is on, the unit will not turn on even if it is forced to. The unit will be idled for about 20 minutes and can be restarted after the green light comes on.



**4** Select one of the four cleaning methods recommended earlier.

**a.** When the heater is needed, press TEMP button to select one of the 5 preset temperatures. Press Heater button,  flashes, indicating the heater is turned on. When the water reaches the set temperature,  dims, indicating the heater is turned off.

To ensure safety, the unit is designed with dual protections. The heater will be turned off automatically if it has been running for 50 minutes.

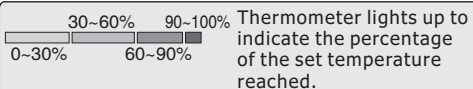

**b.** If solution is added, to speed up the mixing and to use less solution, use degas function. Press TIME button to set the timer to 10 minutes then press Function button,  illuminates. Press On/Off to start degassing. It changes over to normal cleaning automatically after 90 seconds.

**c.** When debris "smoke" is no longer visible, cleaning is done. If additional cleaning is needed, reset the timer and repeat the steps above.

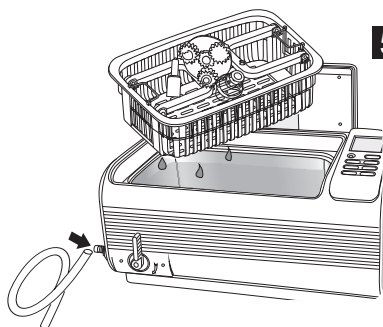

**5** When cleaning is completed, switch off the power, open the lid and retrieve the basket and the items. Alternatively, raise and suspend the basket above water as illustrated in the Usage Guide for Accessories section to drain water.

Connect the hose to the drainage pipe as shown. Open the drainage valve to drain the dirty water. Clean and wipe the tank dry. Close the drainage valve.

## CARE AND MAINTENANCE

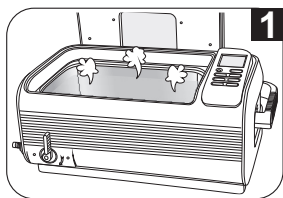

### **Do not turn on the unit without water in the tank.**

Even though the unit is designed with multiple protections, if it is turned on for over 30 seconds without water in the tank, it may damage the unit or severely reduce the life of the unit. If heating over 3 minutes, it will damage the heater.



This unit is equipped with a thermal cutoff. If the cleaning function is turned on without water in the tank, the temperature will rise continuously. The thermal cutoff will be actuated after approximately 15 minutes respectively to ensure safety. The unit will be disabled until it's repaired.

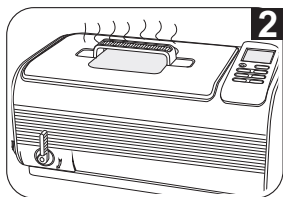

### **Do not run the unit for extended time or continuously.**

The unit is designed with overheat protection. If the unit has been running for 45 minutes, it is recommended to stop the unit for about 20 minutes to prolong the life of the unit.

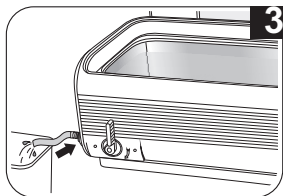

### **Do not keep water in the cleaning tank for a long time.**

After cleaning is completed, open the drainage valve to drain the dirty water. Clean and wipe the tank dry.

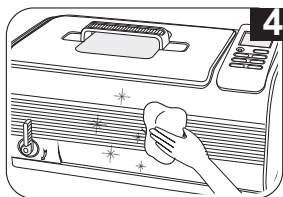

### **Do not spray water over the housing.**

Use a towel to wipe the tank and the housing dry.

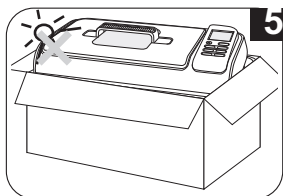

### **Do not expose the unit under direct sunshine for a long time.**

Keep the unit in a dry, cool and ventilated area.

# USAGE GUIDE FOR ACCESSORIES

## Plastic Basket:

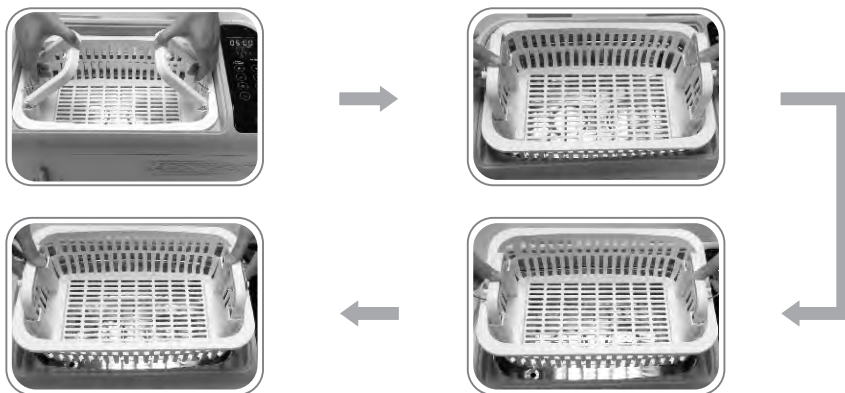

The basket has foldable handles.  
It can be raised and suspended above water to drain water.

## Indirect cleaning tank.



Put it atop the fixed tank as shown.  
Add water in the fixed tank.  
Add chemicals or special solutions in the indirect cleaning tank.  
Cleaning efficiency can reach 90% of direct cleaning.