

ProCart II™ Mobile Treatment Console

OPERATION MANUAL

© Copyright 2011 DNTLworks Equipment Corporation
09/20/2011
All Rights Reserved

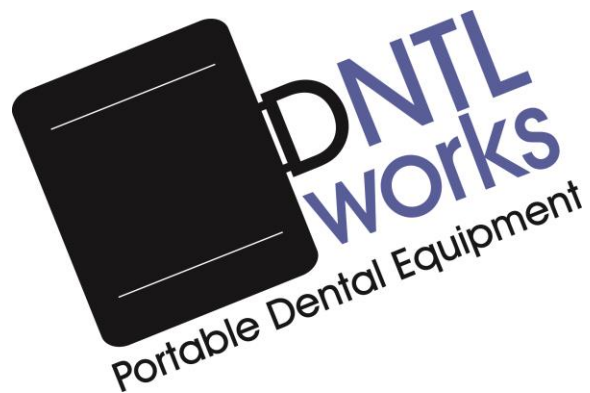

DNTLworks Equipment Corporation
7300 South Tucson Way
Centennial, Colorado 80112 USA

Toll Free: (800) 847-0694
Main: (303) 693-1410
Fax: (303) 693-6189

Contents

Introduction	3
Customer Service	4
DNTLworks Limited Warranty.....	4
Returns.....	5
Description of Unit.....	5
Air System	5
Water System.....	5
Vacuum System.....	5
Electrical System	5
Specifications	5
Unit Features.....	6
Top View	6
Front View.....	7
Back View	8
Operation	9
Setup	9
Handpiece Operation.....	10
Three-way Syringe	11
Vacuum System.....	11
Water Bottle.....	13
Accessories.....	13
Dental Office Infection Control Guidelines (CDC).....	14
Barrier Techniques	14
Cleaning and Disinfection of Dental Unit and Environmental Surfaces	15
Use and Care of Handpieces and Other Intra-oral Dental Devices.....	15
Other Important Issues	16
Shut Down Instructions.....	16
Maintenance	19
Electrical Diagram	20
Air Diagram	21
Water Diagram.....	22

Vacuum Diagram.....	23
Back, Inside View	24
Pumps, Inside View	25
Air and Vacuum Tanks, Inside View	26
Shelf, Inside View	27
Control Panel, Inside View	28
Troubleshooting Flow Charts	29
Handpiece Water	29
Syringe Water	30
Air Regulator Adjustment	30
Waste Leak.....	31
Poor Vacuum.....	31
Compressor Will Not Shut Off or Will Recycle Often.....	32
Compressor Will Not Start	33
Compressor Will Not Recycle or Stalls	33

Introduction

Thank you for purchasing the ProCart II™ Mobile Treatment Unit from DNTLworks Equipment Corporation. The information contained in the manual should answer any questions regarding service and operation of your ProCart II™ unit.

All authorized personnel who operate, maintain, or service your ProCart II™ unit should carefully review this manual before attempting to operate, perform maintenance on or service the unit. Your ProCart II™ unit should be operated and maintained by trained personnel only. Should questions or problems arise, contact our Customer Service Department.

Although your ProCart II™ unit has been designed and tested for maximum safety and optimum performance, it is sold with the express understanding that DNTLworks, its subsidiaries, agents and representatives will not accept any responsibility for the following, including, but not limited to:

- 1) Operator’s lack of knowledge, negligence or carelessness in the operation of this equipment.
- 2) Equipment not properly maintained or serviced.
- 3) Injury to personnel or patients from improper use.
- 4) Modification or tampering of any kind.

Customer Service

In the event you require assistance with your unit, please call 1-800-847-0694 or 303-693-1410 and speak with one of our customer service representatives. Our service hours are from 8:00 a.m. to 5:00 p.m., Mountain Standard Time, Monday through Friday.

In most instances, service problems may be solved over the telephone. If service is required, you may ship the unit to our manufacturing facility for repair. Warranty service will be performed in accordance with the DNTLworks' Limited Warranty. Non-warranty service will be provided at reasonable parts and labor costs.

DNTLworks Limited Warranty

DNTLworks warrants to the purchaser that these products are free of defects in materials and/or workmanship for three (3) full years from date of delivery, on a "parts only" basis. In addition, DNTLworks extends a ninety (90) day labor warranty from the date of delivery for all products we manufacture. Shipping charges incurred to the factory under warranty purposes will be the responsibility of the owner.

During the warranty period, all parts which, upon inspection and examination by DNTLworks, are proven to be defective, will be replaced free of charge. All decisions concerning whether a part will be repaired or replaced and the manner, method, and extent of such repair or replacement will be at the sole discretion of DNTLworks. The responsibility of DNTLworks does not include repair and replacement cost resulting from misuse, abuse, improper maintenance, or normal wear and tear.

DNTLworks will pay for labor costs for warranty service for a period of 90 days from the date of purchase. DNTLworks sole obligation under said warranty is to repair, or, at its option, replace the defective part. The buyer will have no options.

Warranties for products not manufactured by DNTLworks, but sold in combination with DNTLworks products, will be honored by DNTLworks for the entire duration of the original manufacturer's warranty period.

The warranty will be voided by alterations, tampering with, improper installation or maintenance, accident or modification of the equipment, with the exception of work performed by DNTLworks or one of its authorized service agents. This warranty expressly excludes all damage to the products resulting from careless or neglectful transportation. DNTLworks will in no event be responsible for any work done without first obtaining DNTLworks' written consent.

This warranty is made expressly in lieu of all other warranties, expressed or implied, including any implied warranties of merchantability or fitness for a particular purpose. No employee, agent, franchise, dealer or other person is authorized to give any warranties of any nature on behalf of DNTLworks. Except as provided herein, DNTLworks will have no liability or responsibility to the customer or any other person or entity with respect to any liability, loss or damage caused or alleged to be caused directly or indirectly by equipment sold, leased, or furnished by DNTLworks, including, but not limited

to, any interruption of services, loss of business or anticipatory profits or consequential damage arising out of or connected with the sale, lease, use, or anticipated use of equipment. Notwithstanding the above limitations and warranties, DNTLworks liability hereunder for damages incurred by customer or other will not exceed the amount paid by customer for the particular equipment involved.

Returns

Purchased goods may not be returned without the express written consent of DNTLworks and a Return Goods Authorization Number (RGA#). All items must be returned within 14 days of initial delivery and are subject to a 15% restocking charge. Special order items cannot be returned for credit consideration. Freight charges on approved return items shall be borne by the customer.

Description of Unit

ProCart II™ is an easy-to-clean, self-contained operatory system that sets up in just a few minutes. It requires no plumbing and is mobile for ease of movement between operatories or for storage.

Air System

The internal air compressor will activate when main power switch is turned on, filling the air tank and pressurizing the water reservoir. The compressor will deactivate when air pressure reaches 100psi and will recycle at 70psi.

Water System

Water container should be filled 3/4 full. Water to handpieces is controlled by the foot control toggle and the valves on the front of the unit. The water for the air/water syringe is controlled by depressing the water button on the syringe. Syringe water pressure is controlled by the water regulator at a maximum of 40psi.

Vacuum System

The internal vacuum system is activated by removing HVE or saliva ejector from holder. You may use either the saliva ejector or HVE as needed. There is a vacuum solids trap and a waste purge pump. In the vacuum container is an automatic shut down system to prevent spillage. Cannot used Saliva Ejector and HVE at the same time.

Electrical System

There are two electrical outlets on your system, one internal outlet and one external, to accommodate accessories. You may use a maximum of 2 amps on the internal and external outlets. The unit is protected by a 15 amp circuit breaker.

Specifications

Dimension	Length	20" (51cm)
-----------	--------	------------

	Width	21" (53cm)
	Adjustable Height	30" (76cm) to 34" (86cm)
Total Weight		100lbs (45.5 Kg)
Electrical	Voltage	115 or 220Vac
	Frequency	60 or 50 Hz
	Wattage	1200 to 1440 W
Compressor	Horsepower	1/3 Hp
	Working Pressure	70 to 100psi
	Flow Rate	2.5scfm @ 40psi
	Air Tank	1 Gallon (4 Liter)
Vacuum Pump	Horsepower	1/3 Hp
	Pressure	12 inHg
	Flow Rate	4.6 scfm
	Container	1 Gallon (4 Liter), 7.5 Pints Useable.
Unit Sound	Full Load	48dB @ 3'

Unit Features

Top View

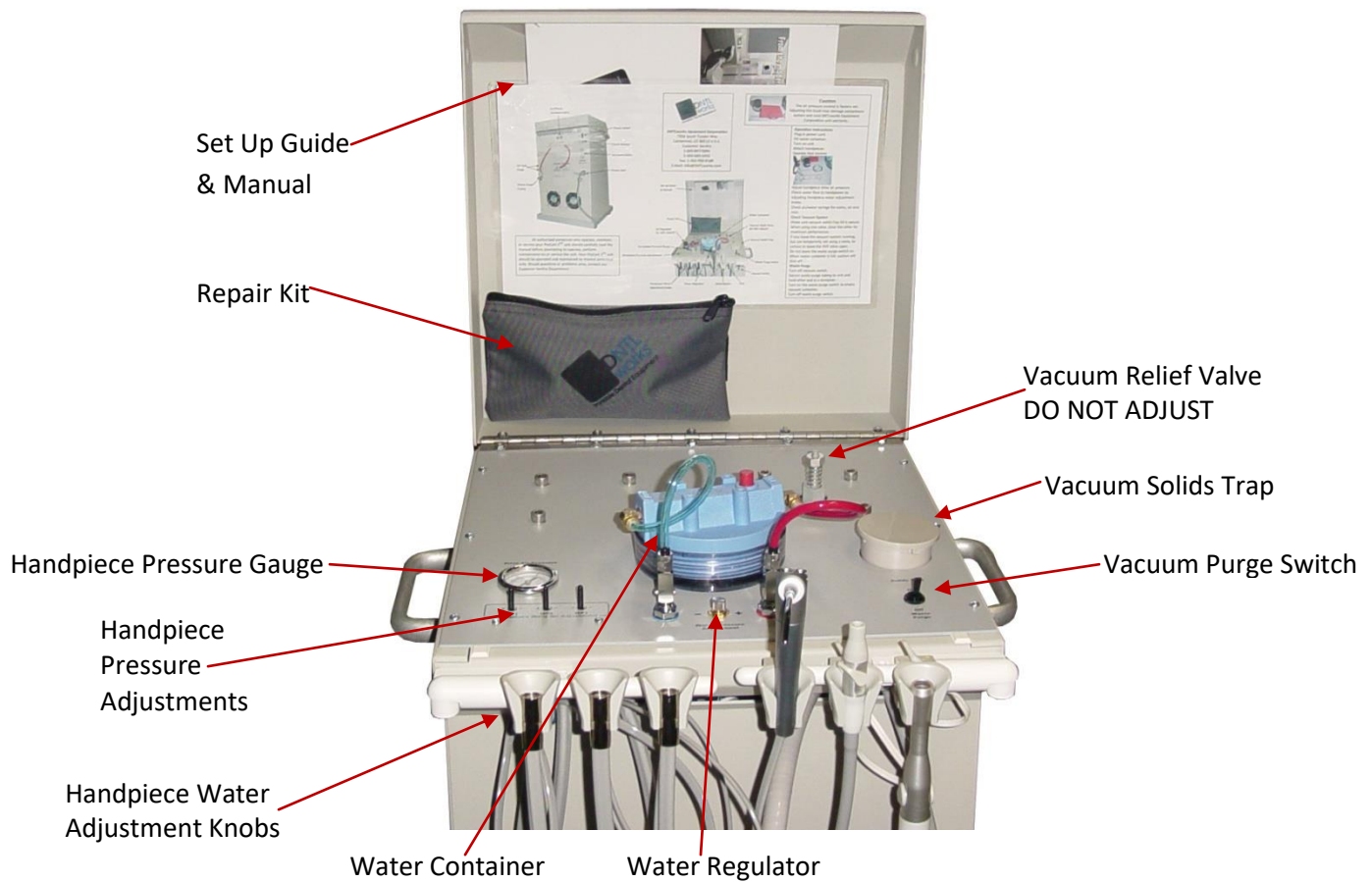

Front View

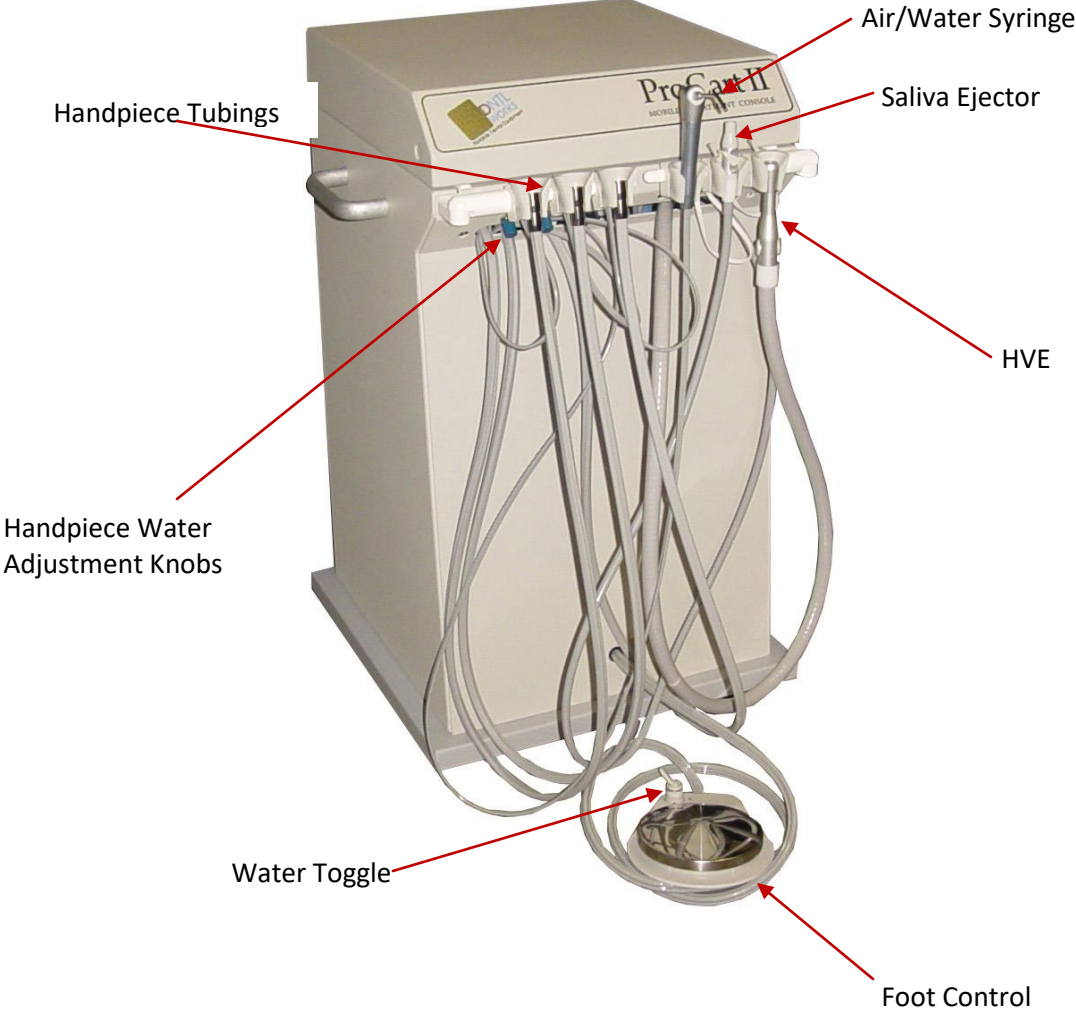



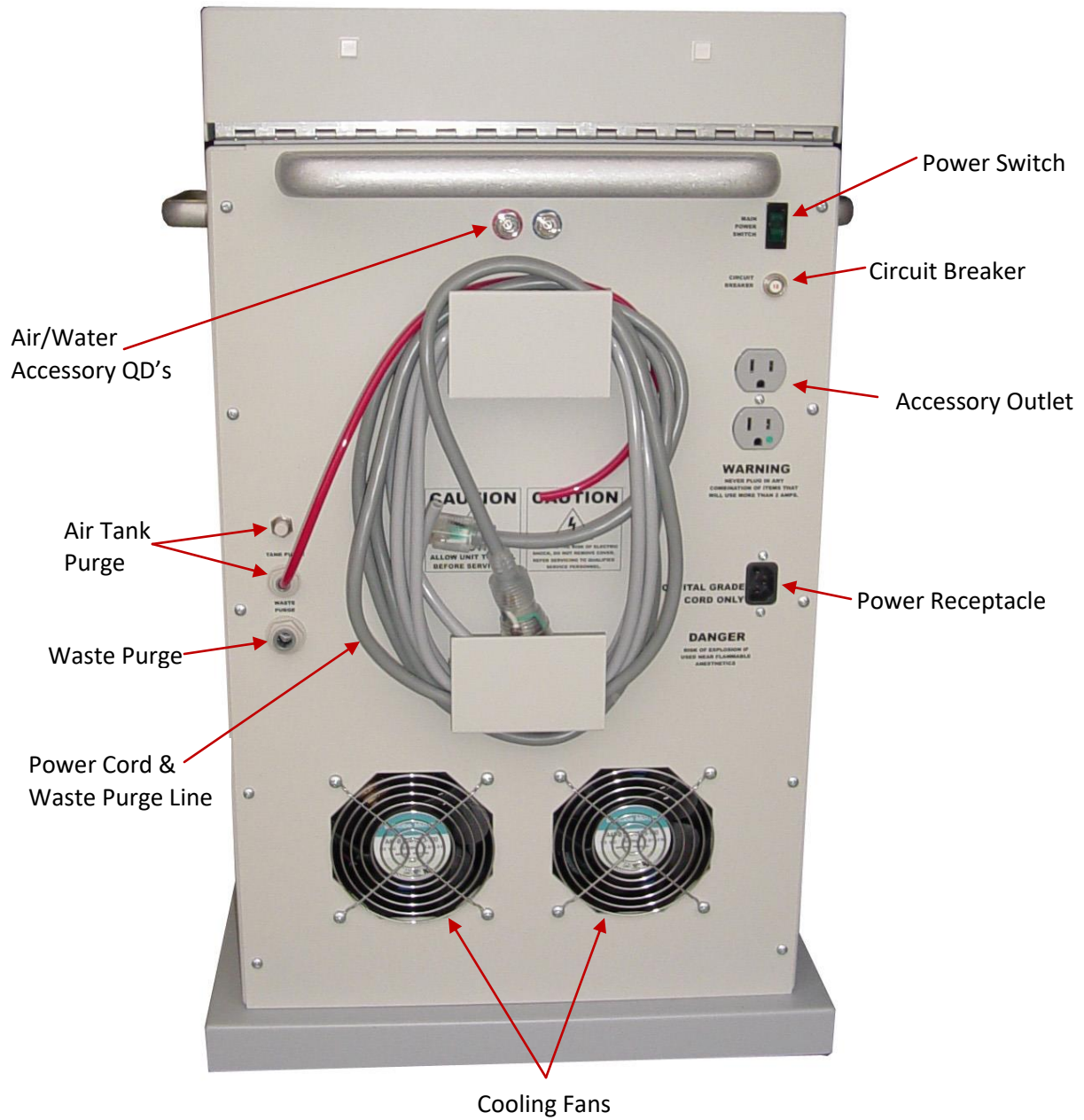







Back View



Operation

Setup

 <p>Place foot control near the operator.</p>	 <p>Install handpieces.</p>
 <p>Install saliva ejector tip. Install HVE tip.</p>	 <p>Plug power cord into power receptacle and into wall outlet. Make sure the ProCart II is the only unit on the circuit.</p>
 <p>Connect waste purge tubing.</p>	 <p>Turn on power switch.</p>
 <p>Fill water container 3/4</p>	 <p>Connect water container to unit.</p>
 <p>Remove handpiece and depress foot control. Adjust pressure to manufacturer's setting. Repeat for other handpieces.</p>	 <p>Turn on water toggle.</p>

Remove handpiece from holder. Depress foot control and adjust handpiece water. Repeat for other handpieces.



Test air and water on syringe.



Turn toggle on holder to the ON position.



Remove HVE or saliva ejector from holder.

Handpiece Operation

Remove handpiece from holder.



Depress foot control.



When using a handpiece, make sure air pressure does not exceed handpiece manufacturer's recommended pressure. When setting the maximum handpiece pressure, always make sure foot control is fully depressed, and adjust handpiece air adjustment valve.

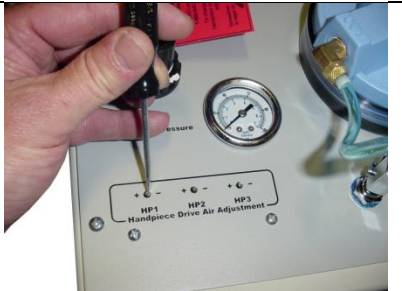



Turn on foot control toggle valve. If the handpiece does not require water, turn toggle off.

For handpiece coolant water, adjust water valve while fully depressing foot control.







Always clean handpieces between patients. See Dental Office Infection Controls Guidelines CDC. Below.

Three-way Syringe

 <p>Water only.</p>	 <p>Air only.</p>
 <p>Air and water (mist). You can use disposable syringe tip kits. (A-dec type disposable tip kit) Always clean syringe between patients. See Dental Office Infection Controls Guidelines CDC, below.</p>	

Vacuum System

	<p>When using either saliva ejector or HVE, make sure the other valve is closed. Cannot use Saliva Ejector and HVE at the same time. Always clean vacuum system between patients. See Dental Office Infection Controls Guidelines CDC, below.</p>
 <p>Move toggle to ON position.</p>	 <p>Remove HVE or saliva ejector and open valve.</p>
<p>Before using saliva ejector always check screen.</p> 	<p>Replace solids trap as needed.</p> 



Never adjust vacuum relief valve.
When using saliva ejector, vacuum relief valve will have an air leak sound.

Purge Vacuum System

Make sure purge tubing is installed.

Always clean vacuum system between patients.
See Dental Office Infection Controls Guidelines CDC, below.
To clean vacuum system, use a non-foaming vacuum system cleaning solution.



Hold end of purge line over a container.









Turn on waste purge.
Never leave purge pump running when not purging system.

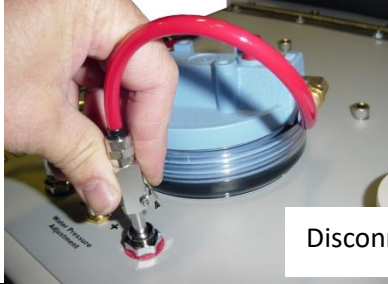

Cleaning Between Patients and End of Day

- 1) Remove any waste in vacuum container by purging and disposing of contents in a CDC-approved manner. See Dental Office Infection Control Guidelines CDC, below.
- 2) Mix one quart of evacuation cleaner, turn on evacuation system and suction cleaner into waste bottle using the HVE valve, and the saliva ejector.
- 3) Dispose of cleaner waste in CDC-approved manner.
- 4) Wipe down outside of the bottle and tubings with a surface cleaner.
- 5) Clean tubings and handpieces in CDC-approved manner.
- 6) Clean unit surfaces CDC-approved manner.

Water Bottle

	<p>Disconnect red air line.</p>	 <p>Depress red pressure relief valve.</p>
	<p>Disconnect blue water line.</p>	<p>Make sure o-ring is not missing and is seated in the groove.</p>  <p>Lubricate o-ring as needed.</p>
	<p>Fill about 3/4 full. We recommend distilled water only.</p>	<p>Reconnect water and air lines.</p> 
	<p>You can adjust the water pressure to the air/water syringe.</p>	

Accessories

	<p>The inside outlet is used for accessories built into the unit, such as fiber optic systems or water heaters, etc.</p> <p>Never use more than 2 amps between the inside and outside outlets.</p> <p>Questions: Call Customer Service.</p>
---	---



The outside outlet is used for external accessories use.

Never use more than 2 amps between the inside and outside outlets.

The air 1/4" QD is used for accessories that require air. The pressure will be between 70 to 100psi. The accessory should not be used at the same time you are using one of the handpieces. You may connect to an external air or nitrogen system. Make sure the pressure does not exceed 100psi.



The water 1/4" QD is used for accessories that require water. The pressure will be 65psi.

You may connect to an external water system. Make sure the pressure does not exceed 65psi. You will need to disconnect the water bottle from the unit.

Dental Office Infection Control Guidelines (CDC)

DENTAL OFFICE INFECTION CONTROL GUIDELINES FOR THE PROTECTION OF PATIENTS AND DENTAL CARE PERSONNEL AS RECOMMENDED BY THE UNITED STATES CENTERS FOR DISEASE CONTROL (CDC)

NOTE: A medical history should be taken at the initial patient visit and on recall, updated with notations made on the chart.

Barrier Techniques

- 1) Dentists, hygienists and assistants should wear new gloves for each patient treated. Hands should always be washed with liquid soap before and after treatment, contact with patients or after touching inanimate objects likely contaminated by blood or saliva, and before leaving the operatory. Remove torn, cut or punctured gloves immediately, wash hands, and re-glove before completion of dental procedures.
- 2) During all treatment procedures, dentists, hygienists and assistants should wear face masks and protective eyewear, or in lieu of both of these, a chin-length plastic face shield.

3) Reusable and/or disposable gowns, laboratory coats or uniforms should be worn when street clothing may be soiled with blood or other body fluids. Gowns should be changed at least daily or when visibly soiled with blood.

Cleaning and Disinfection of Dental Unit and Environmental Surfaces

1) After treatment of each patient and at the completion of daily work activities, countertops and dental unit surfaces that may have become contaminated with patient material should be cleaned with disposable toweling, using an appropriate cleaning agent and water as necessary. Surfaces then should be disinfected with a suitable chemical germicide.

2) A chemical germicide registered with the EPA as a “hospital disinfectant” and labeled for “tuberculocidal” (i.e., mycobactericidal) activity is recommended for disinfecting surfaces that have been soiled with patient material. These intermediate level disinfectants include phenolics, iodophors, and chlorine-containing compounds. Because mycobacteria are among the most resistant groups of microorganisms, germicides effective against mycobacteria should be effective against many other bacterial and viral pathogens. A fresh solution of sodium hypochlorite (household bleach) prepared daily is an inexpensive and effective intermediate-level germicide. Concentrations ranging from 500 to 800 ppm of chlorine (a 1:100 dilution of bleach and tap water or 1/4 cup of bleach to 1 gallon water) are effective on environmental surfaces that have been cleaned of visible contamination. Caution should be exercised, since chlorine solutions are corrosive to metals, especially aluminum.

3) Low-level disinfectants - EPA registered “hospital disinfectants” that are not labeled for “tuberculocidal” activity (e.g., quaternary ammonium compounds) - are appropriate for general housekeeping purposes such as cleaning floors, walls and other housekeeping surfaces. Intermediate and low level disinfectants are not recommended for reprocessing critical or semi-critical dental instruments.

4) Before high-level disinfection or sterilization, and while wearing heavy duty rubber (household) gloves, ultrasonically clean (preferably) or scrub instruments in order to remove debris.

Use and Care of Handpieces and Other Intra-oral Dental Devices

1) Routine between-patient use of a heating process capable of sterilization (i.e., steam under pressure (autoclaving), dry heat, or heat/chemical vapor) is recommended for all highspeed dental handpieces, lowspeed handpiece components used intra-orally, and reusable prophylaxis angles. Manufacturers’ instructions for cleaning, lubrication, and sterilization procedures should be followed closely to ensure both the effectiveness of the sterilization process and the longevity of these instruments. According to manufacturers, virtually all highspeed and lowspeed handpieces in production today are heat tolerant and most heat-sensitive models manufactured earlier can be retrofitted with heat-stable components.





2) Internal surfaces of highspeed handpieces, lowspeed handpiece components, and prophylaxis angles may become contaminated with patient material during use. This retained patient material then may be expelled intra-orally during subsequent uses. Restricted physical access - particularly to internal surfaces of these instruments - limits cleaning and disinfection or sterilization with liquid chemical germicides. Surface disinfection by wiping or soaking in liquid chemical germicides is not an acceptable method for reprocessing highspeed handpieces, lowspeed handpiece components used intra-orally, or reusable prophylaxis angles.

3) Highspeed handpieces should be run to discharge water and air for a minimum of 20-30 seconds after use on each patient. Handpieces, in addition, should be heat sterilized between uses on patients. This procedure is intended to aid in physically flushing out patient material that may have entered the turbine and air or water lines. Use of an enclosed container or high-velocity evacuation should be considered to minimize the spread of spray, splatter, and aerosols generated during discharge procedures. Additionally, there is evidence that overnight or weekend microbial accumulation in water lines can be reduced substantially by removing the handpiece and allowing water lines to run and to discharge water for several minutes at the beginning of each clinic day. Sterile saline or sterile water should be used as a coolant/irrigation when surgical procedures involving the cutting of bone are performed.

Other Important Issues

- 1) A “no-touch” technique (e.g., hemostats or needle holders), should be utilized when using “sharps” (needles, scalpels, blades, etc.).
- 2) In the operatory, sterilized and decontaminated instruments, charts, and other objects should be protected from patient contact.
- 3) “Sharps” should be disposed of in puncture proof containers; hazardous and/or infectious waste materials, which include “sharps,” should be disposed of in a manner consistent with prevailing local laws.
- 4) All dental personnel should be encouraged to receive immunization protection whenever possible, e.g., hepatitis B immunization.
- 5) All impressions, models and devices should be disinfected before submission and upon receipt from the dental laboratory.

Shut Down Instructions

	<p>Depressurize and remove water container.</p>	<p>Wipe dry.</p> 
	<p>Replace water container.</p>	<p>Turn on foot control toggle valve.</p> 

 <p>Open all water valves.</p>	 <p>Place handpieces over container and depress foot control until all water is purged.</p>
 <p>Depress syringe water button until all water is purged.</p>	 <p>Remove all handpieces and vacuum attachments.</p>
 <p>Turn on vacuum.</p>	 <p>Mix non-foaming vacuum cleaning solution and run solution through HVE valve.</p>
 <p>Run cleaning solution through saliva ejector valve.</p>	 <p>Turn off vacuum.</p>
 <p>Make sure purge tubing is installed.</p>	 <p>Hold end of purge line over a container.</p>



Turn on waste purge.



Wipe water container dry.



Turn off power switch.



Place paper towel under air regulator bowl.
Depress pin valve at the bottom of bowl to drain moisture.
Unit must be pressurized.



Place air tank (red) purge line over a container.



Depress tank purge valve until all air and moisture is removed from air tank.



Before closing lid, disconnect water container.

Maintenance

The following visual checks should be performed before operating the unit:

- 1) Look for mechanical damage that could affect safe operation, including, but not limited to, the following:
 - a. Cracks in power cord.
 - b. Splits or kinks in air or water lines.
 - c. Check for cracks in water container.
 - d. Cracks, kinks or splits in handpiece tubing, syringe tubing and vacuum tubings.
- 2) Look for loose or missing items, including, but not limited to, the following:
 - a. Loose or missing screws, nuts and/or bolts.
 - b. Loose handles.

Should mechanical or other damage be noted that would affect safety or operation, the unit should not be used until repair or replacement of defective items is completed. You may call Customer Service for help.

!!CAUTION!!

Handpieces:

Follow manufacturers' instructions for maintenance.

Syringe:

Follow manufacturer's instructions for maintenance.

Air Pressure Source:

Do not exceed 100 psi.

Electrical Diagram

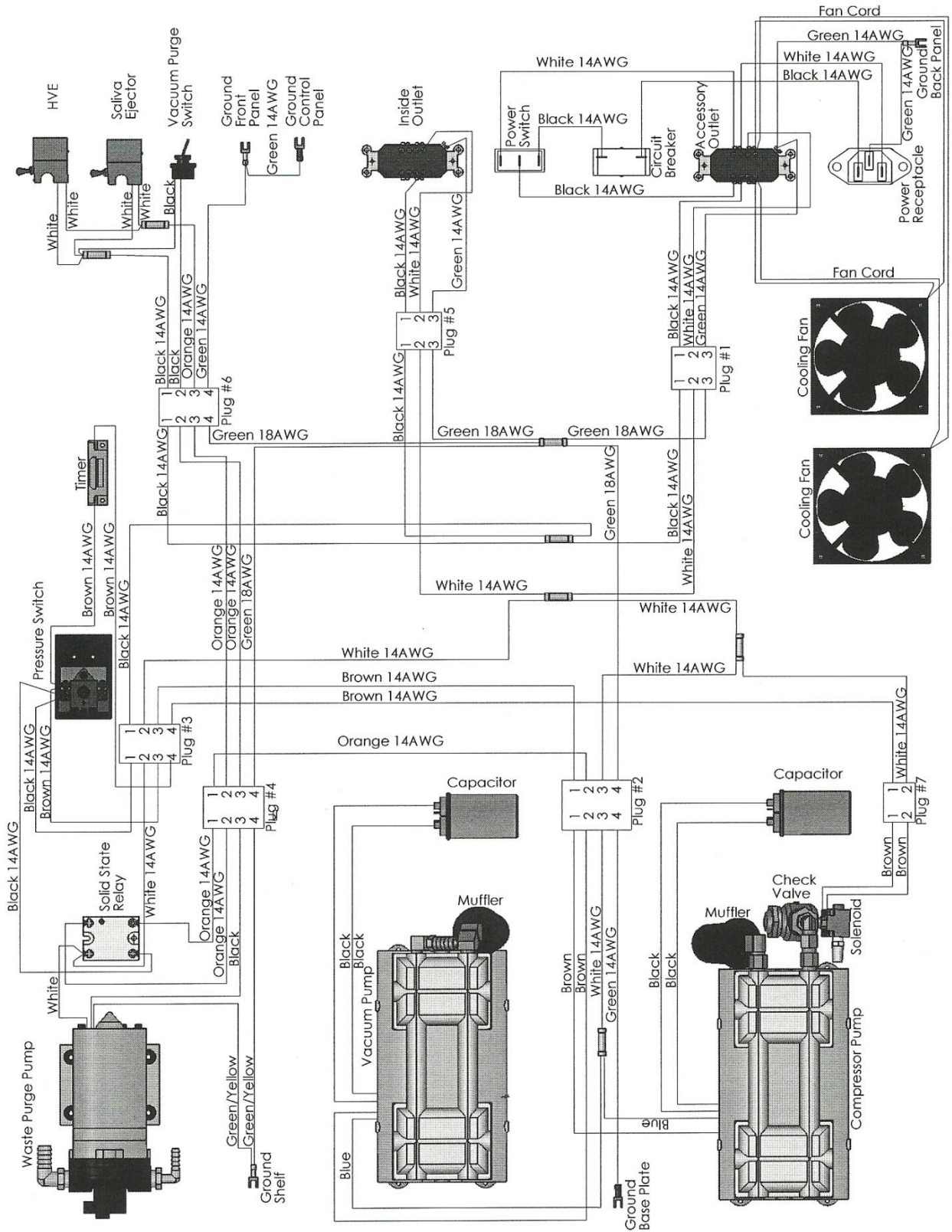

Air Diagram

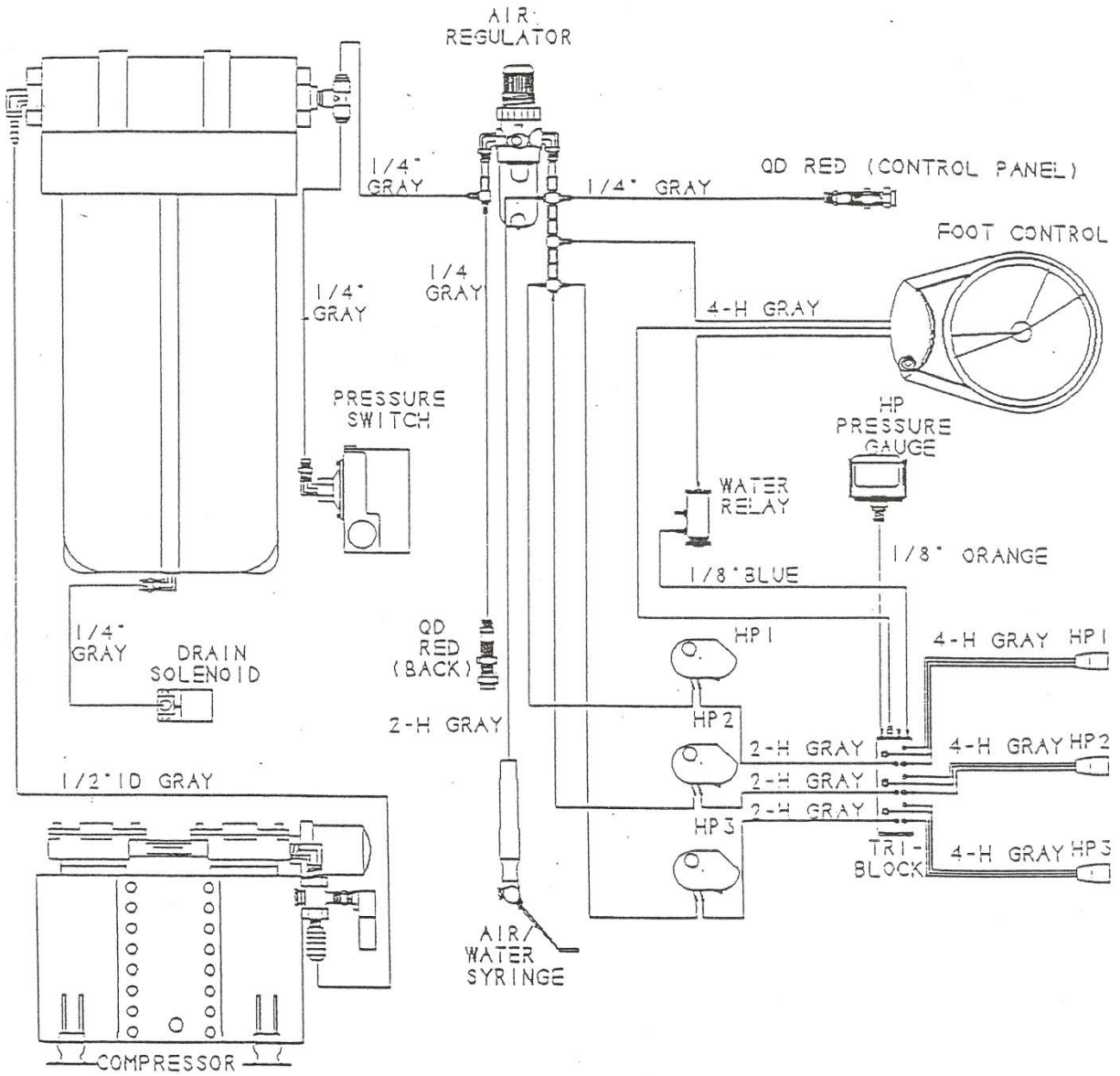

Water Diagram

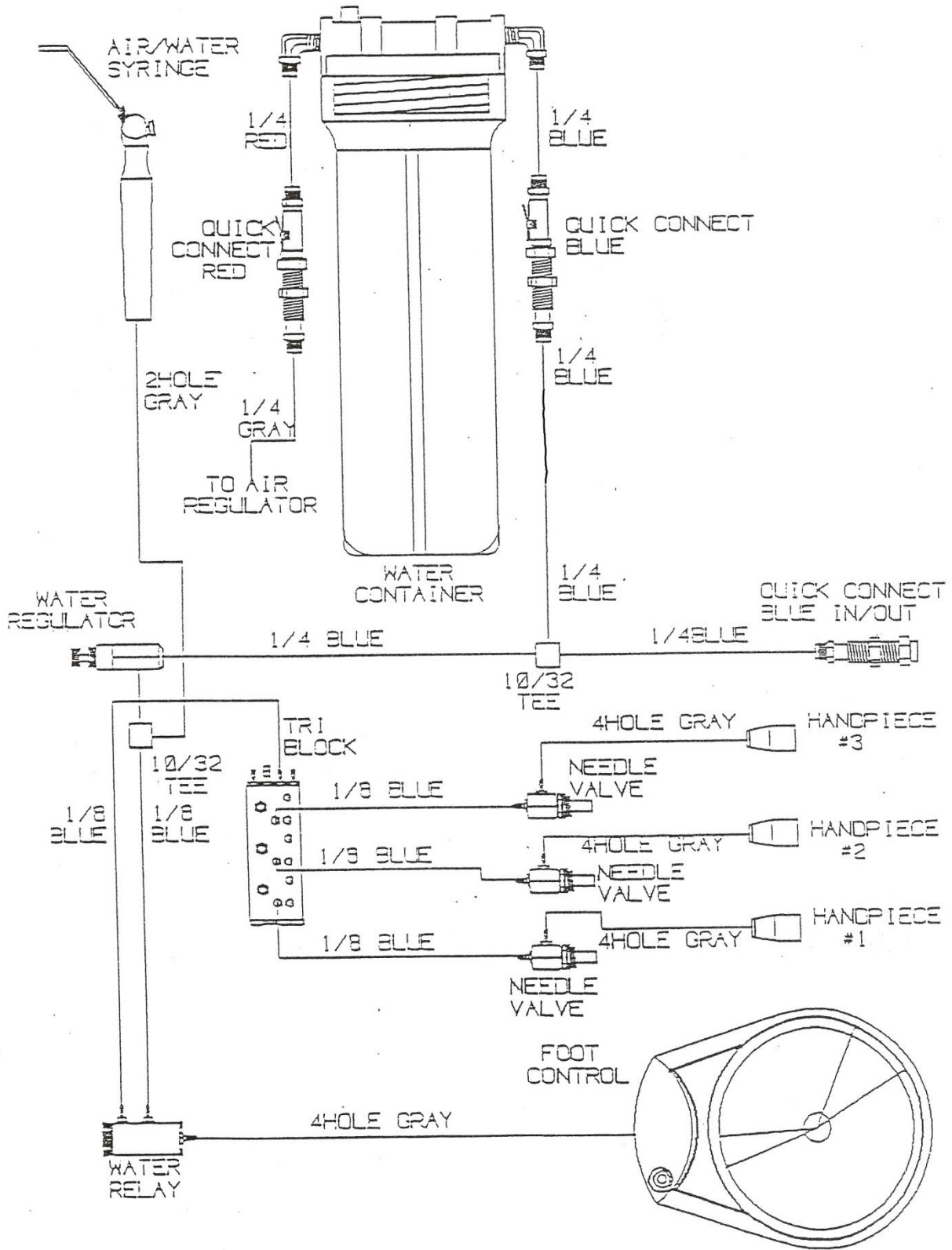

Vacuum Diagram

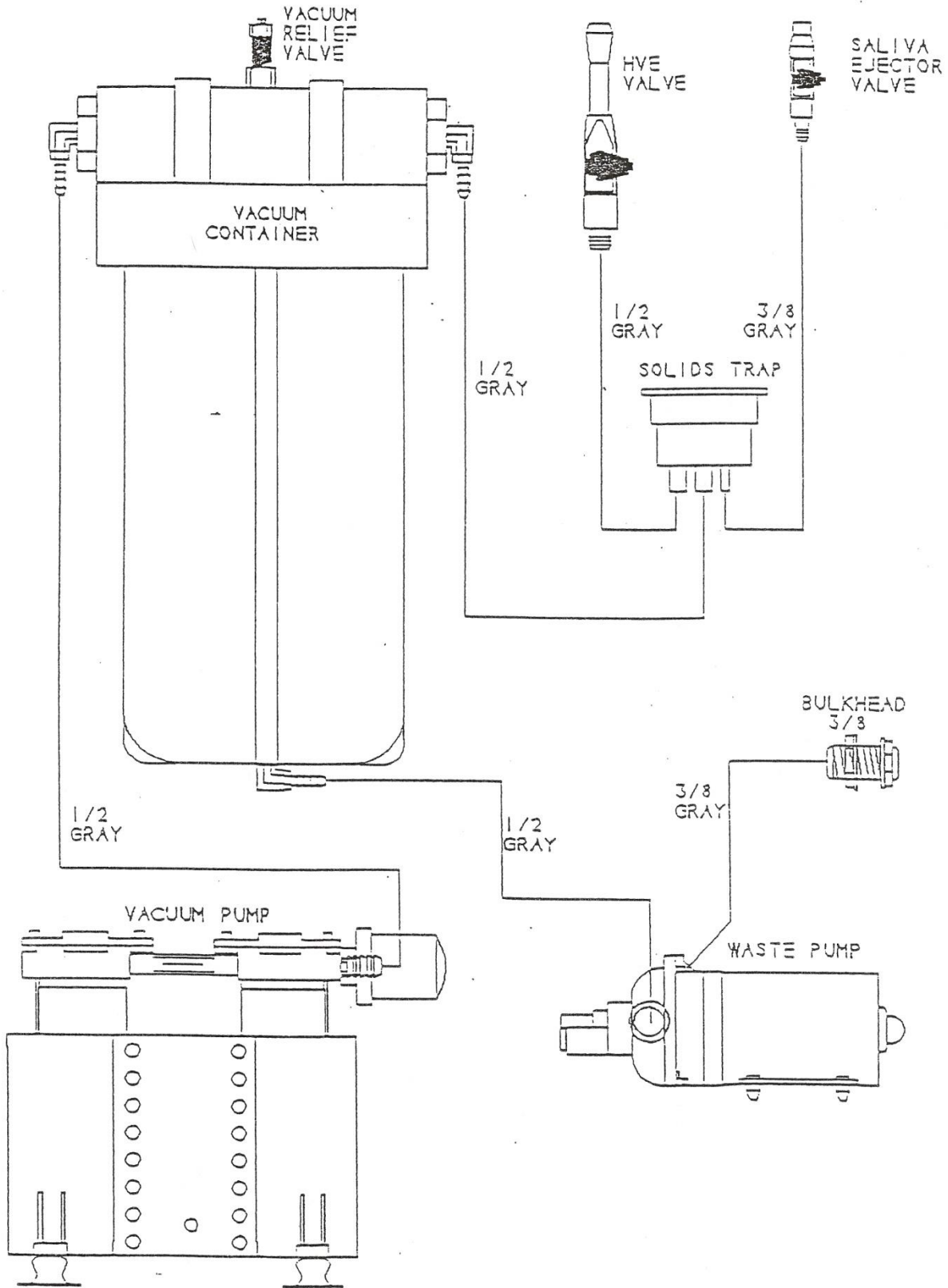

Back, Inside View

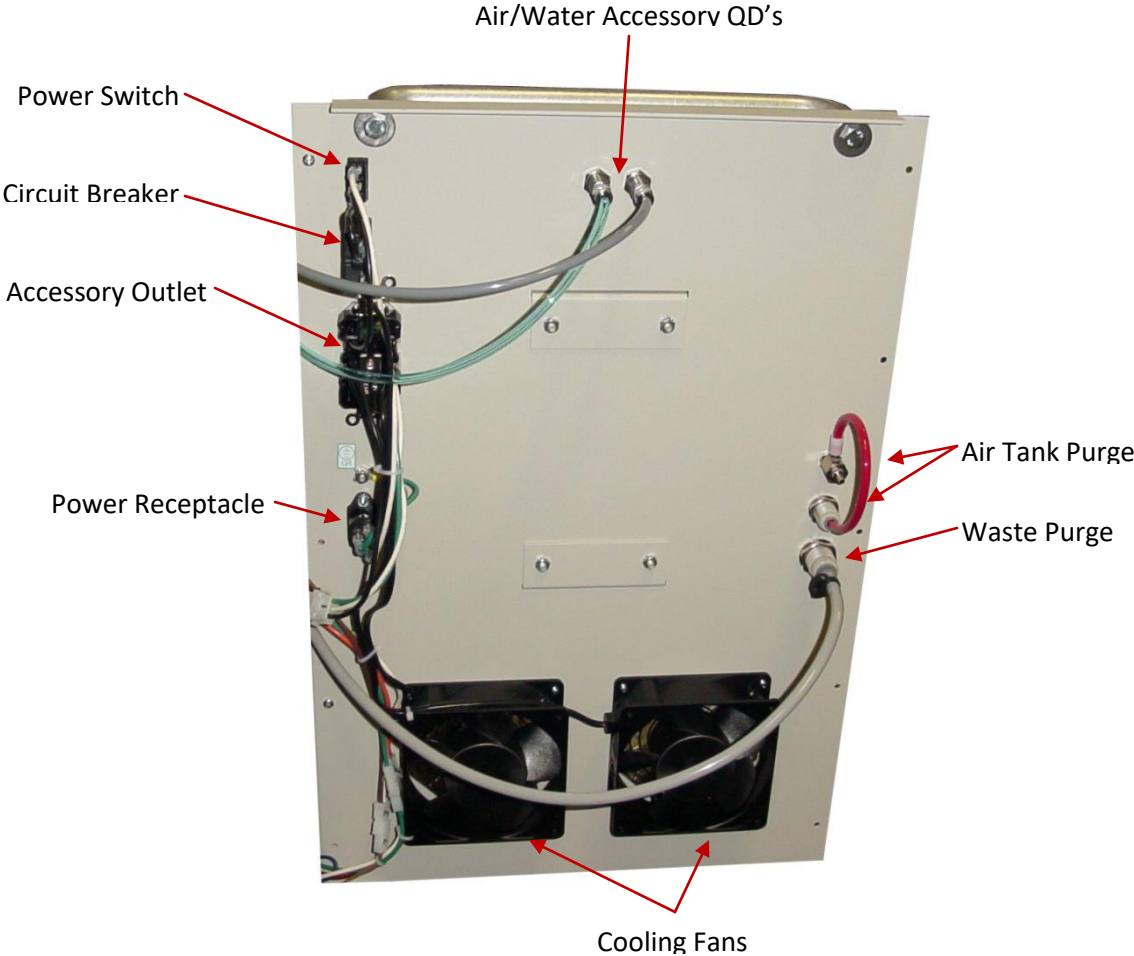

Pumps, Inside View

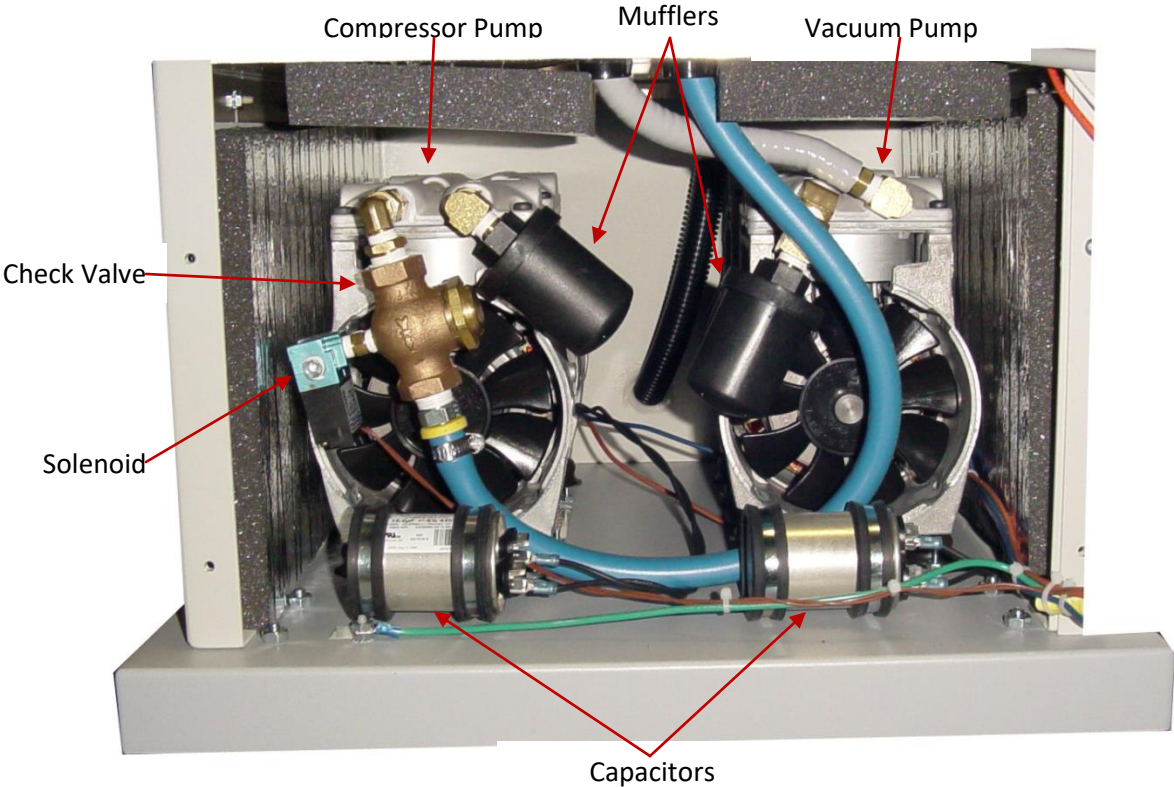

Air and Vacuum Tanks, Inside View

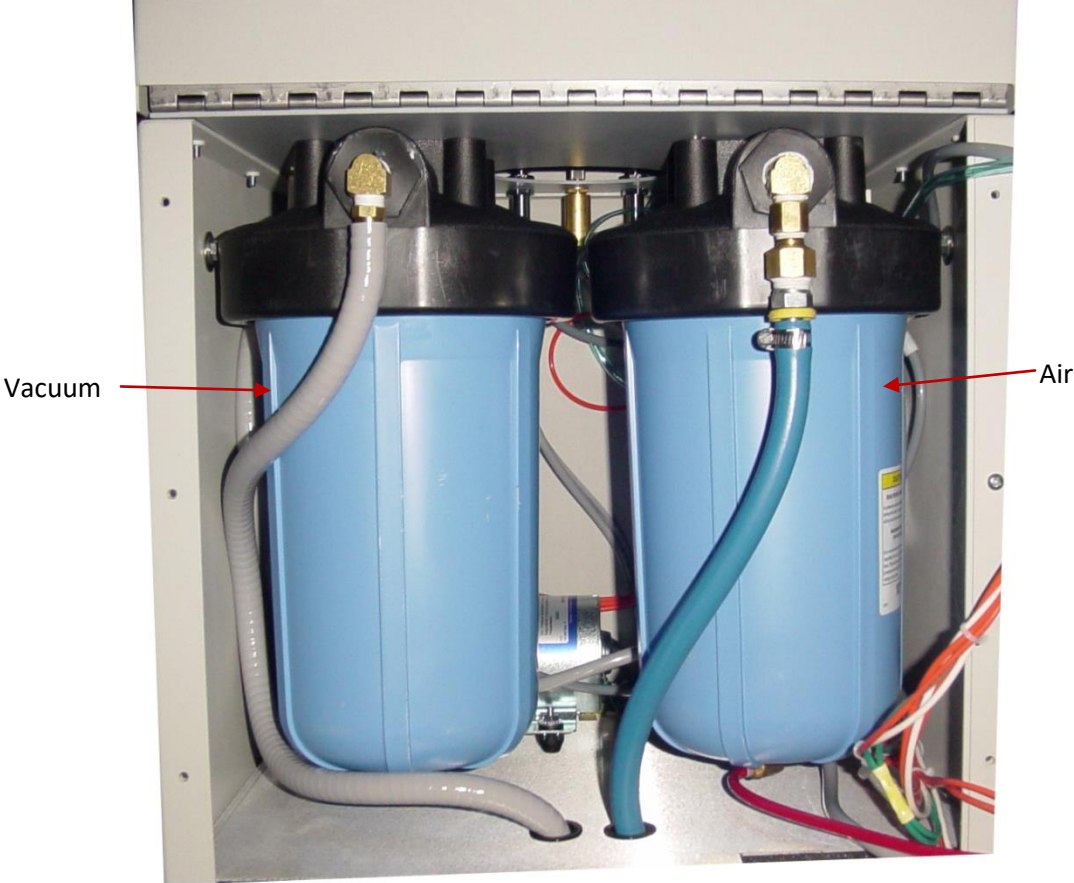

Shelf, Inside View

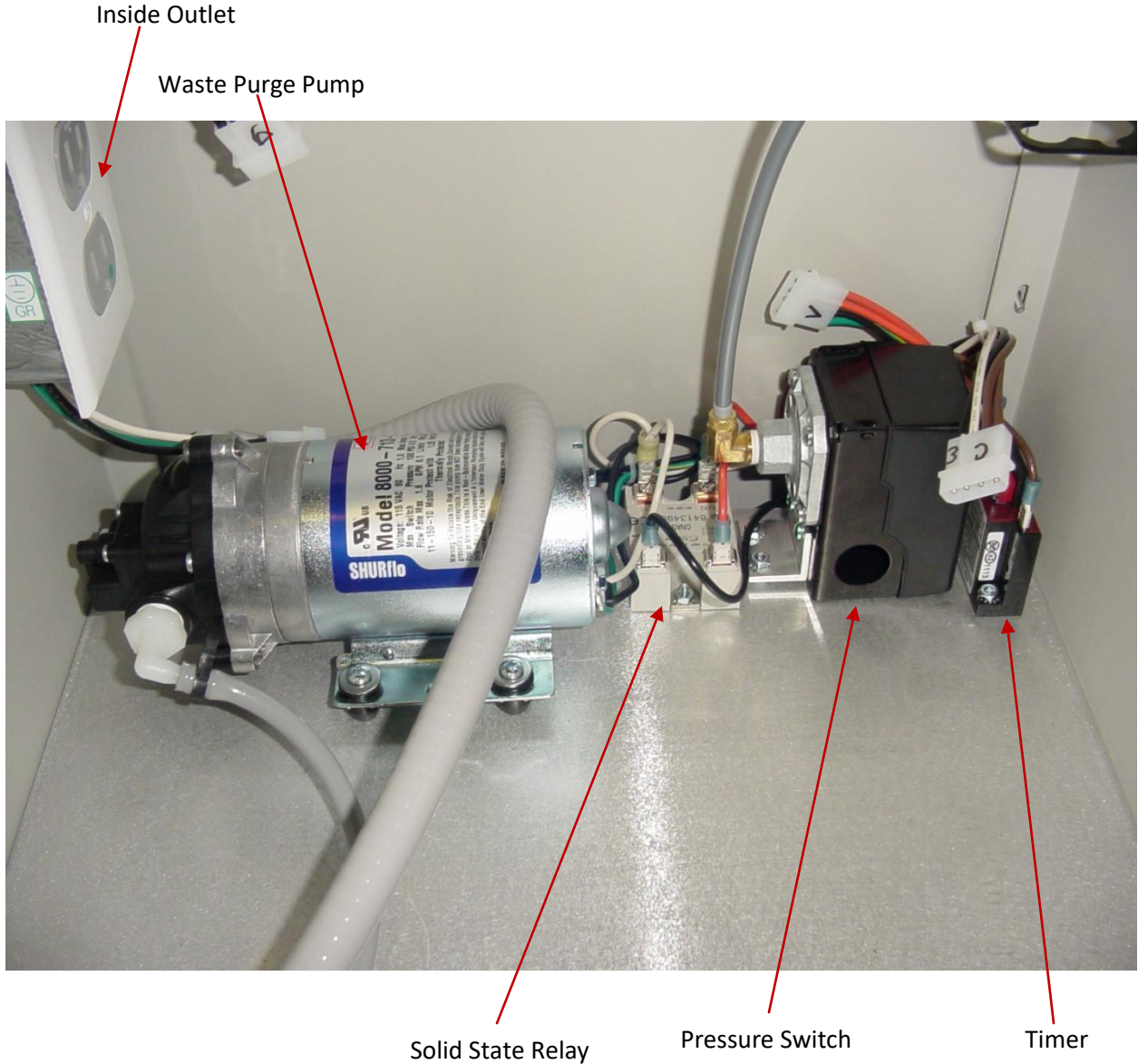

Control Panel, Inside View

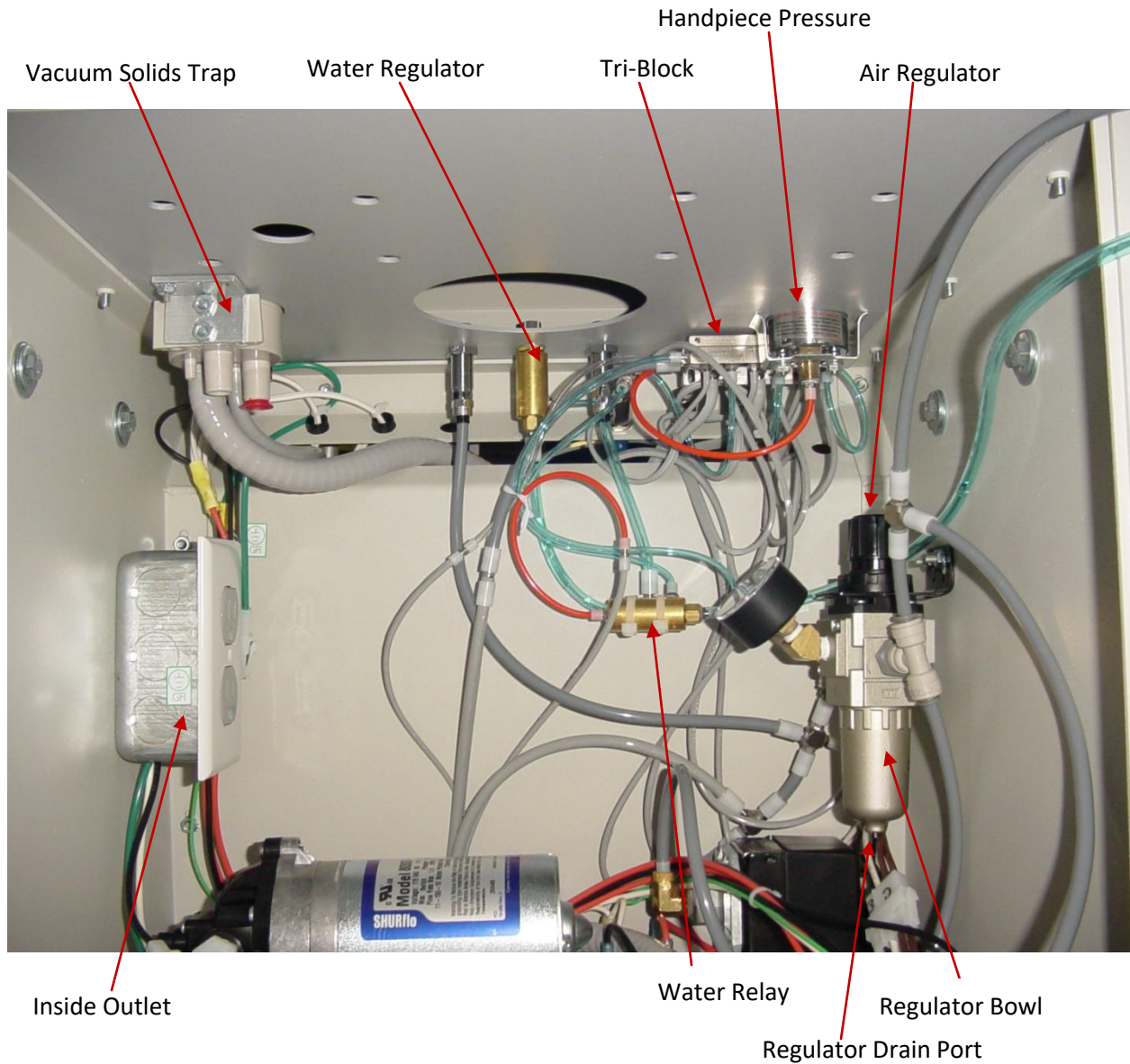

Caution

The air regulator is factory set. Adjusting this knob may damage the compressor system and void the DNTLworks Equipment Corporation unit warranty.

Troubleshooting Flow Charts

Handpiece Water

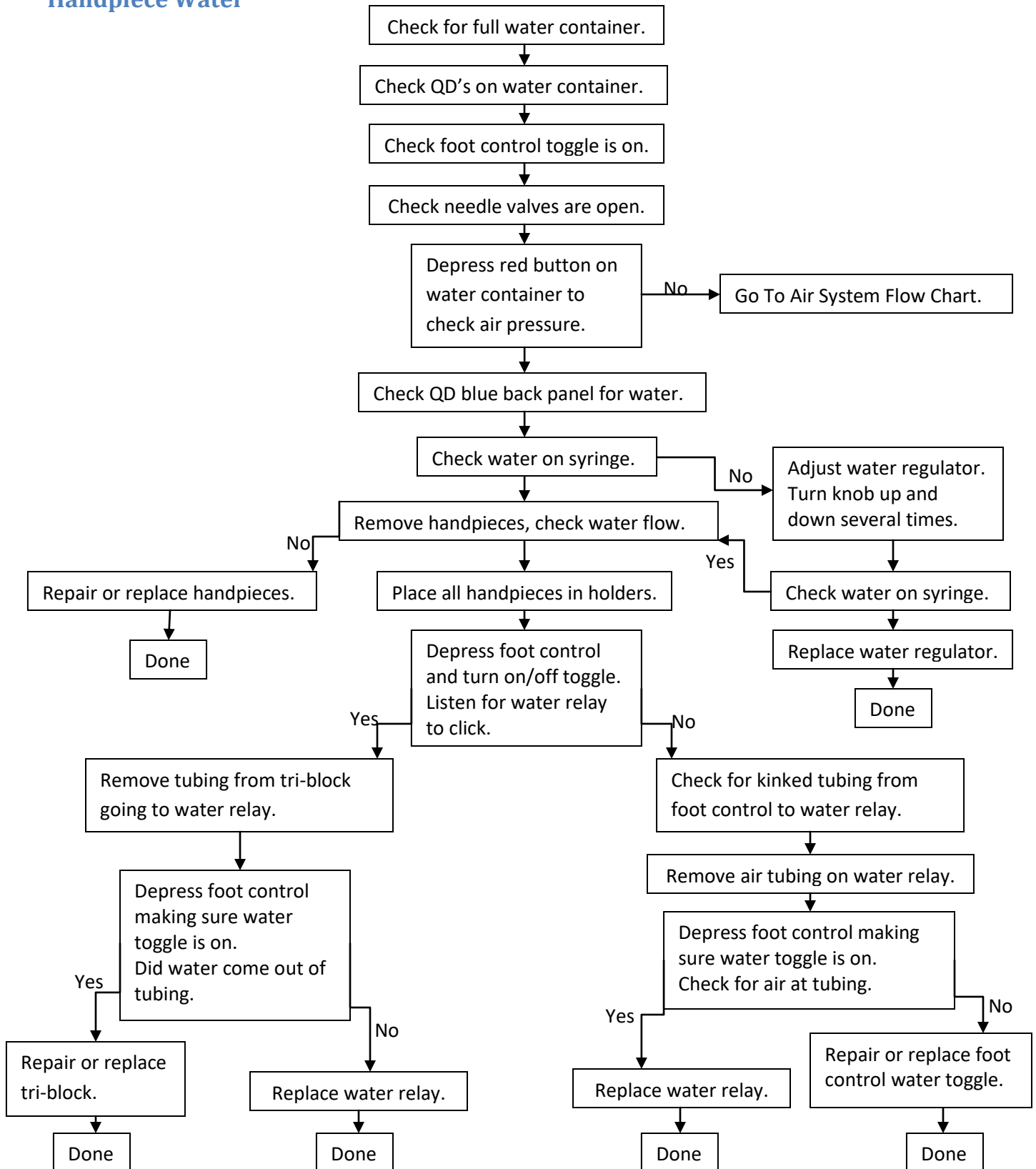

Syringe Water

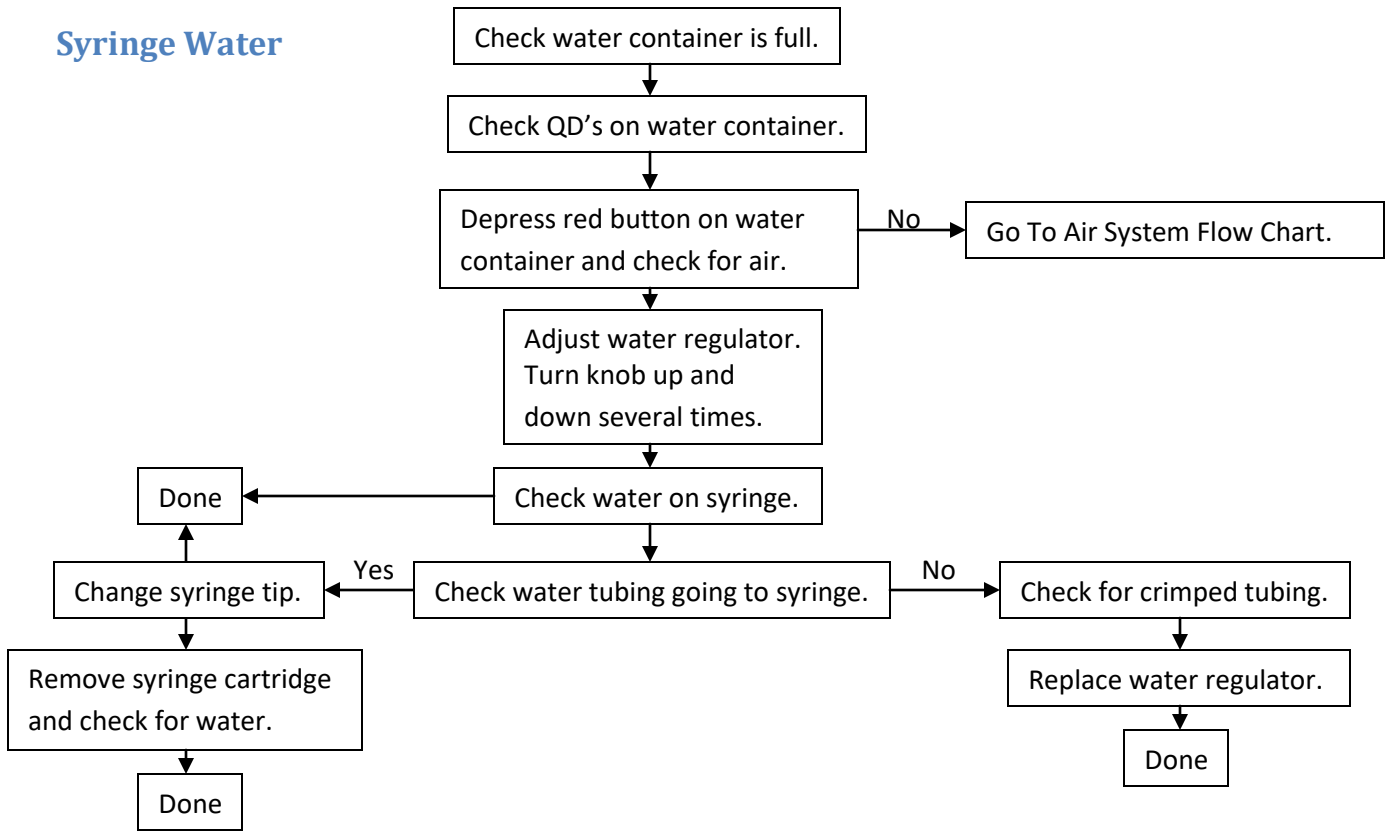

Air Regulator Adjustment

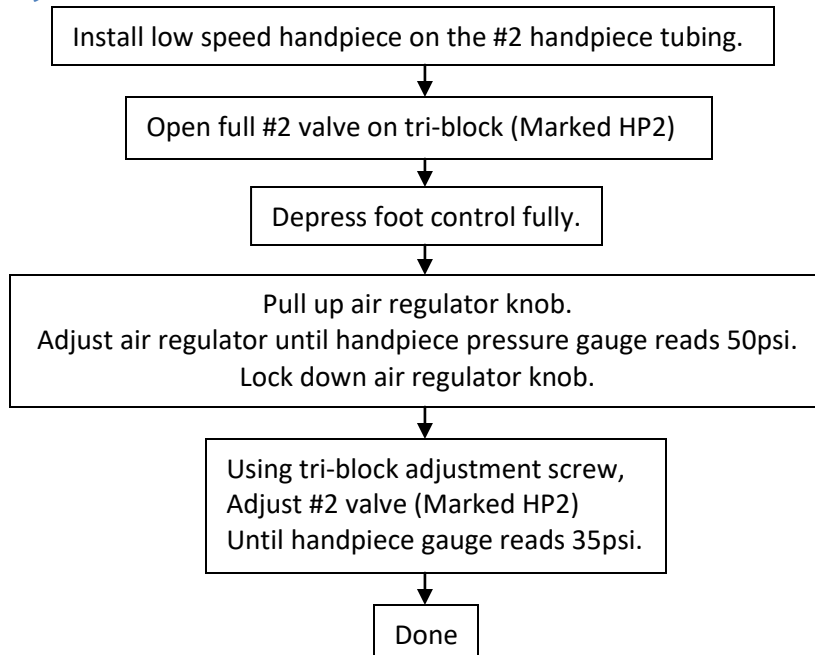

Waste Leak

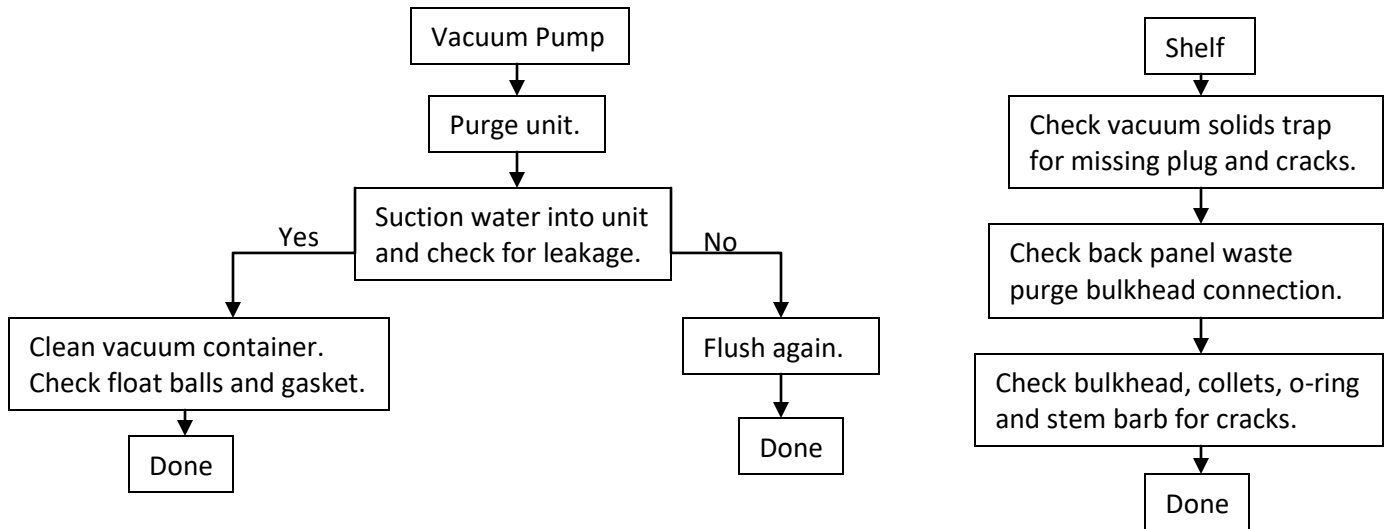

Poor Vacuum

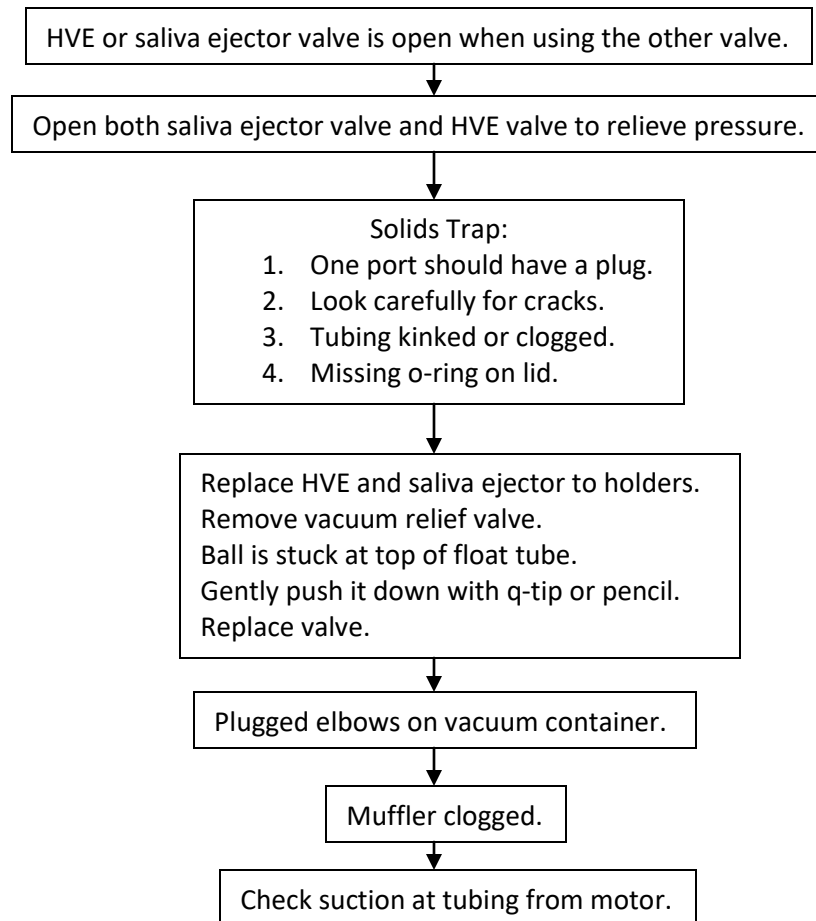

Compressor Will Not Shut Off or Will Recycle Often

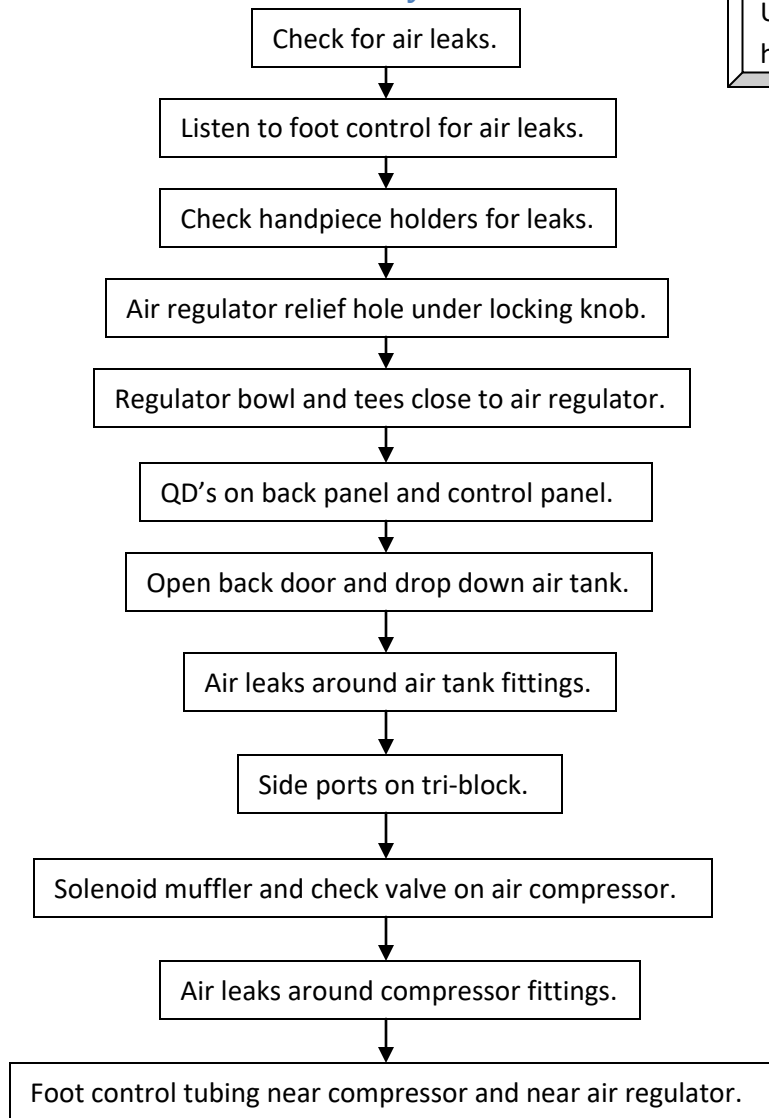

Compressor Will Not Start

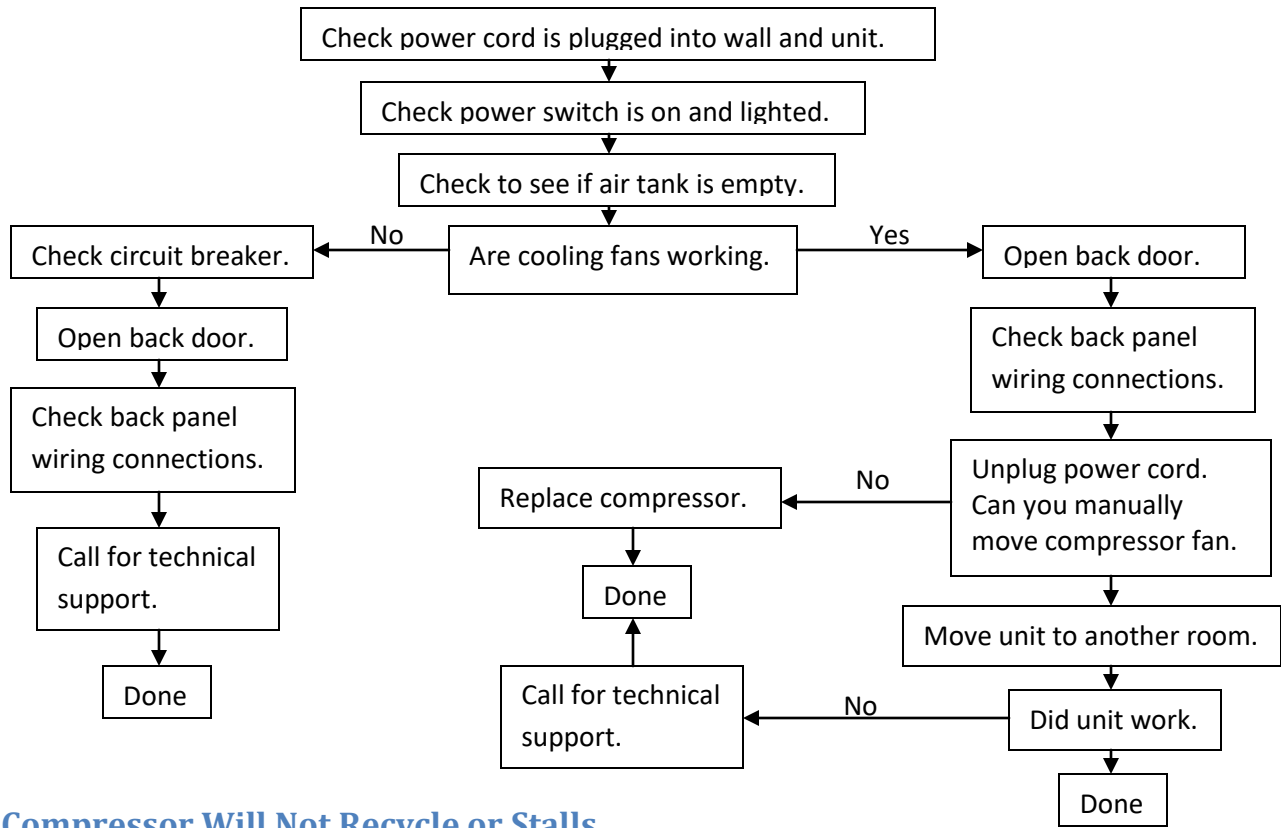

Compressor Will Not Recycle or Stalls

