

bernette

SWISS DESIGN



BERNETTE SEWING MACHINE WORKBOOK

For bernette models b37 and b38



TABLE OF CONTENTS

Introduction..... 3

Sewing Machine Needles..... 4

Thread..... 6

bernette Presser Feet 7

Stitch Selection 8

Securing Stitches 9

Turning Corners..... 10

Zigzag Stitch 11

Blind Hem 12

Triple Straight Stitch 13

Overlock Stitch 14

Stretch Stitch 15

Buttonholes 16

Attaching Buttons..... 17

Stitching Zippers..... 18

Decorative Stitching..... 19

Satin Stitching 20

Stitch Combinations/Memory..... 21

Alphabets..... 22

Double Needle Stitching..... 23

Supplies..... 24

Stitch, Function, and Foot Charts..... 25



The information in this workbook applies to bernette models: b37 and b38.

Note: Some exercises apply only to certain models equipped with the feature being highlighted.

INTRODUCTION

Congratulations on the purchase of your new bernette sewing machine. The information in this workbook will help you learn the basics of using your new machine.

This workbook is designed to be used as a step-by-step guide to familiarize you with the basic operation of your bernette sewing machine. Once you have completed the exercises designated for your machine, attach the sewn samples to the information pages (or add a facing page for mounting) and insert the pages into plastic page protectors to store in a 3-ring binder. They can then be used as a reference tool in the future as you use your machine and explore the creative possibilities it affords.

Stitch and function charts for each bernette model are found on pages 26-27. Each stitch exercise page has a graphic of the stitch(es) used so you can quickly find it on the chart and then locate it on your machine.

Each page with a stitching exercise ends with a “Sew How” box. This mini-quiz will let you test your knowledge and review the points related to the exercise.

Taking the class is just the first step. Using the information on a regular basis will help make it become part of your sewing skill set.

Instructional video tutorials for these models are available on mybernette.com. You will also find inspiring sewing projects and machine information on the bernette website.

www.mybernette.com



Sewing Machine Needles

Needle "Secret" Code

- DRI = Triple
- E = Embroidery
- J = Jeans
- L, LL, R = Leather
- M = Microtex
- MET = Metallic
- N = Topstitching/
Cordonnet
- Q = Quilting
- S = Stretch
- SUK = Fine Ball Point
- SES = Medium Ball Point
- WING = Wing
- ZWI = Double
- ZWIHO = Double Wing

Needle Size Conversion

Regardless of the system, the greater the number, the larger the diameter of the needle.

European vs. Domestic

60=8	90=14
70=10	100=16
75=11	110=18
80=12	120=19

Needle Size for Fabrics

60 – very fine batiste
 70 – shirt-weight
 80 – medium-weight
 90 – denim and twill
 100/110/120 – canvas

General Information

Along with thread, needles are very important to stitch formation. Many "mechanical" problems and damage to fabrics can be traced to a bent, damaged, or incorrect size or type needle.

When selecting the correct needle, consider the following:

- Needle system – 130/705H
- Needle point – assures proper stitch formation; avoids fabric damage
- Needle size – smaller for lightweight fabrics; larger for heavier fabrics

If the needle is:

- Too small – the thread can't stay in the groove to form a loop to be picked up by the hook point
- Bent – the thread loop forms too far away from hook point and the hook can't enter the loop to form a stitch
- Blunt – the needle won't pierce fabric, so no thread loop forms to make a stitch

Need to Know

- Needles should be changed after every 4-6 hours of stitching. The needle is the most inexpensive part in your sewing machine, but it is crucial for getting good results and keeping your machine running well.
- Don't let false economy keep you from doing what is best for your sewing projects and your machine.
- The selected thread should fit in the groove on the front of the needle. If it isn't protected by the groove, a needle with a larger groove should be used.
- Always make sure needles are fully inserted as high as possible, with the flat side to the back.

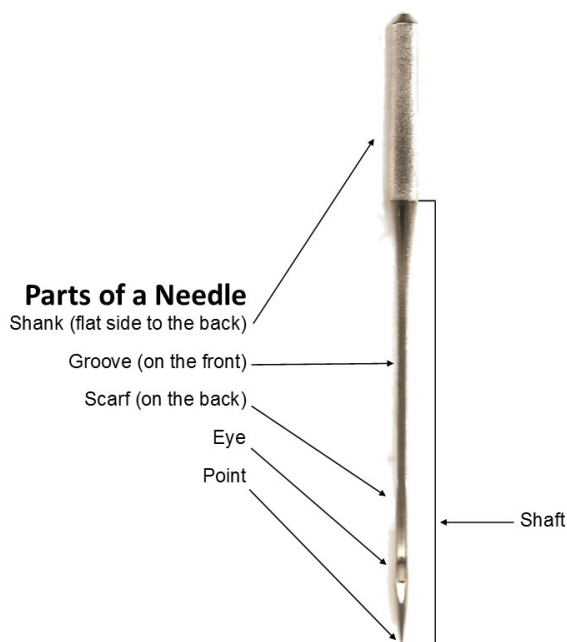

Sewing Machine Needles

TYPE	SIZES	DESCRIPTION
Ballpoint	60 – 100	Has a rounded point. Size 70 for lingerie, nylon, jersey; 80 for t-shirt; 90 for sweatshirt fleece.
Stretch	70 – 90	A Stretch needle has a more rounded point than a Ballpoint, and a blue anti-cling coating which helps to prevent skipped stitches in knits and elastic. Sometimes used on Ultrasuede, vinyl, and plastic.
Universal	60 – 120	A compromise between a Sharp and a Ballpoint; used on both wovens and knits.
Double	1.6/70 – 8.0/100	Two needles attached to one shank. For pintucks, hems, and decorative work. Available in Universal, Stretch, Jeans, Metallic, and Embroidery needles.
Triple	2.5/90 – 3.0/90	Three needles attached to one shank. Used to create mock smocking and other decorative effects.
Jeans	70 – 110	Has a sharp point and a shaft that is less prone to flex. The sharpness of the needle is better for use on denim and woven fabrics.
Leather	80 – 100	Point is a sharp cutting wedge. Used for leather only. Not for vinyl or simulated leathers.
Microtex / Sharp	60 – 90	Sharp point; thin shaft. Specially designed for microfiber fabrics.
Quilting	75 and 90	Thin, tapered point eliminates potential damage to fabric when seaming and cross-seaming.
Topstitch	70 – 100	A sharp point with a large eye and deep groove. For use with heavier fabrics – the large groove cradles heavier threads.
Embroidery	75 and 90	Sharp needle with large eye and groove; has a coating and a larger scarf. Prevents shredding of rayon or metallic threads. Two threads may be used through the eye.
Metafil	80	Similar to Embroidery needle with large eye and deep groove. Made of a heat-resistant alloy with a friction-reducing coating. Suitable for manufactured fibers such as polyester, acrylic, and nylon.
Wing	100 and 110	Sharp-pointed needle with a non-cutting metal wedge on each side. Makes a hole without cutting the threads of the fabric. Used for decorative and heirloom work, such as hemstitching.
Double Wing	100	One Universal needle and one Wing needle attached to a single shank.
Metallic	70 – 100	Designed for metallic threads; has a large eye and deep groove.

Thread

To achieve quality stitches, a sewing machine needs three things: suitable thread, correct needle size, and properly adjusted thread tensions. Poor quality or the wrong type of thread can cause inferior stitches on any machine. Low-quality thread results in crooked and looped stitches, puckered seams, frayed thread, and/or needle breakage. Did you know that thread passes through the eye of the needle approximately 37 times in a "seesaw" action before it forms a single stitch?

Long staple threads are stronger and smoother than short staple threads (Staple refers to the length of fibers twisted together to form a single ply.) Most bargain-priced threads are made of short staple and will deposit more lint and fuzz into your sewing machine, potentially causing tension inconsistencies and possibly even damage to your machine over the long term. Using long staple threads also results in less snagging and fraying.

Ply refers to the number of strands twisted together to make a single thread. The plies are usually indicated by a number after the weight of the thread such as 50/3, which means a 3-ply, 50 weight thread. The lower the weight, the heavier the thread; conversely, higher numbers indicate fine or light-weight thread.

Guidelines for Thread Weights

- 12 wt.— Couching, bobbinwork
- 30 wt.— Embroidery, bobbinwork
- 40 wt.— General construction, quilting, embroidery
- 50 wt.— General construction, piecing, bobbin thread, quilting
- 60 wt.— Lingerie, heirloom, appliqué, bobbin thread, quilting
- 80 wt.— Extra-fine lingerie, heirloom



Fibers

Fiber refers to the type of material used to produce the thread.

Polyester

Good for clothing construction on man-made, natural, or blended fabrics. Tolerates high temperatures. Polyester embroidery thread has a high sheen; excellent for machine embroidery, abrasion resistant, and will not fade.

Cotton

Available in a wide range of weights from 12-100, cotton thread gives a soft, full look to embroidery, applique, and buttonholes. It is also excellent for clothing construction on natural fibers, patchwork piecing, darning and heirloom sewing.

Rayon

A glossy embroidery thread, rayon is not as strong as cotton and polyester fibers, making it useful for decorative work but not for construction techniques.

Silk

Used on silk and wool fabrics, this strong, lustrous fiber is good for construction and decorative details such as buttonholes. Also used for machine and hand basting.

bernette Presser Feet



Every machine needs a presser foot to hold the fabric in place against the feed dog, helping to move it under the needle for stitching. Along with an all-purpose foot for general sewing, other presser feet for specific tasks are included with Bernette machines.

The presser feet are easy to attach with snap-on soles that take only a few seconds to change when needed. In addition to the standard presser feet included with each model, there are additional optional presser feet available for special techniques. For more information, go to <http://mybernette.com>.

Standard Presser Feet



b37 & b38 (A)



b38 (C)

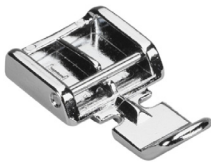

b37 & b38 (E)



b37 & b38 (F)



b38 (F2)



b38 (G)



b37 & b38 (R)



b37 & b38 (T)

Zigzag Foot (A) – An all-purpose presser foot, the Zigzag Foot works well for most general sewing situations - seaming, topstitching, basting, gathering, etc., using the practical/utility stitches of the machines. It is also useful for sewing open decorative stitches, but heavy satin stitches may cause the foot to drag on the dense thread build-up.

Overlock Foot (C) – Use this presser foot with the Overlock Stitch to seam the fabric and overcast the edges in one step, resulting in a narrow seam allowance (about 1/4") that is pressed to one side.

Zipper Foot (E)– This narrow foot lets the needle stitch next to the zipper coil. It is attached to either the right or left sides of the shank, allowing the needle to sew the opposite side of the zipper.

Satin Stitch Foot (F) – Intended for sewing over heavy decorative stitches such as satin stitches, the sole of this foot is designed to move easily over dense thread build-up.

Open Toe Foot (F2) – This foot is the same as the Satin Stitch foot but is open in the front for added visibility of the stitching area.

Blindstitch Foot (G) – Used with the blindstitch, this foot creates a hem that is inconspicuous from the right side of the fabric.

Buttonhole Foot with Slide (R) – Required for creating functional and beautiful buttonholes for any project.

Button-sew-on Foot (T) – This foot is designed to sit on top of a flat 2- or 4-hole button so it can easily be machine-stitched in place.

Stitch Selection

Model b38

With 345 stitches on model b38, the creative possibilities are limitless. Easy selection using the touch panel makes it simple to select your choice of decorative pattern or letter. There are five modes, each with a selected group of patterns. These groups are:

Mode 1 : Direct pattern selection: The numbered keys on the touch panel can be selected by directly pressing the key. Mode 1 is selected when the machine is turned on.

Mode 2 : Utility stitch pattern selection: These stitches are practical stitches such as stretch, overlock, and hemming stitches. This group includes stitches 01-10, which are the same as the Direct Select stitches in Mode 1.

Mode 3 : Decorative stitch pattern selection: A wide variety of edgings, cross stitches, satin-stitched motifs, florals and more; total of 92 patterns.

Mode 4 : Number and letter selection: Alphabet including upper and lower case plus numbers and symbols. Add monograms, names and sayings to your projects.

Mode 5 : European accented letter selection

Mode 6 : Russian (Cyrillic) letter selection

To access a stitch, press the Mode button (lower left corner of the touch panel). The Mode number will appear on the left side of the screen next to the appropriate name.

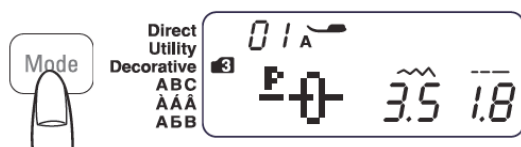

Using the Touch Panel, press the two digit stitch number from the selected mode. Stitch #54 from Mode 3 is now selected.

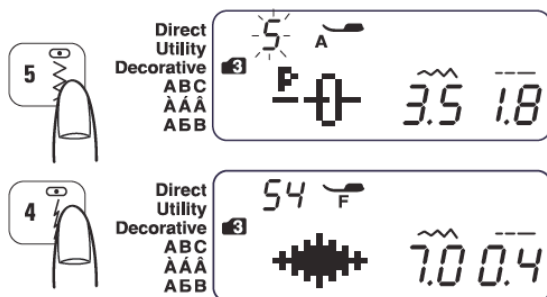

Model b37



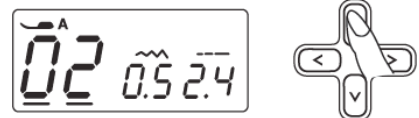
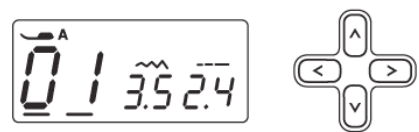

Select any of the 49 stitches of model b37 with a simple toggle button.

Press the cursor buttons (side-to-side) to move the cursor under the stitch pattern number. Note: The cursors appear under both digits when the power is turned on.

Press the value set buttons (up-and-down) to change the stitch pattern number until the pattern number of the desired stitch is indicated.



Securing Stitches

-  Firm fabric, 4" x 6", two pieces
-  80/12 Universal
-  Center
-  Zigzag Foot A

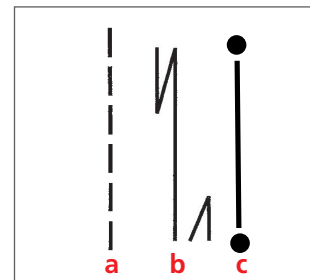

Securing Stitch

b37: Stitch #07

b38: Mode 2 Stitch #07

Locking Stitch

b37: Stitch #14

b38: Mode 2 Stitch #11

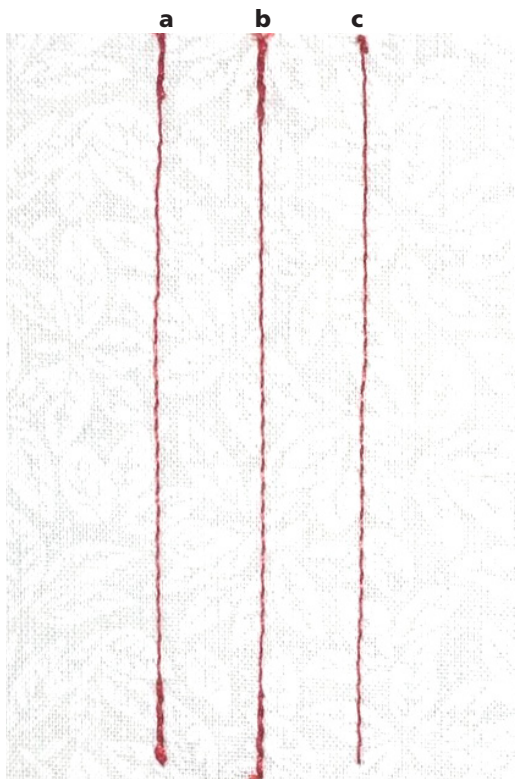

Straight Stitch/Reverse (a)

1. Layer the fabric pieces together and place under the presser foot, aligning one 6" cut edge with the 5/8" guide line on the stitch plate.
2. Select the straight stitch. Sew a few stitches forward, then press the Reverse Sewing button; sew a few stitches backward. the machine will sew in reverse until the Reverse Sewing button is released.
3. Continue stitching the seam; secure the opposite end in the same way.

Securing Stitch (b)

1. Select the Securing Stitch. Sew down the center of the fabric between the 6" edges of the fabric; machine will automatically take five straight stitches forward and back at the beginning to secure the stitching.
2. At the end of the seam, press and release the Reverse Sewing button. The machine will automatically take five stitches backward, five stitches forward to secure the stitching, and then stop.

Locking Stitch (c)





1. Select the Locking Stitch. Sew along the remaining 6" edge of the fabric; machine will take several short stitches at the beginning to secure stitching, then continue stitching forward.
2. At the end of the seam, press and release the Reverse Sewing button and the machine will take several short stitches to secure, and then stop.

Sew HOW

Do you know how to:

- Activate the Reverse Sewing button to backstitch and to end a seam when using the Securing or the Locking stitch?

Turning Corners

-  Firm woven fabric, 4" x 6"
-  Lightweight tear-away stabilizer 4" x 6"
-  80/12 Universal
-  Center
-  Zigzag Foot

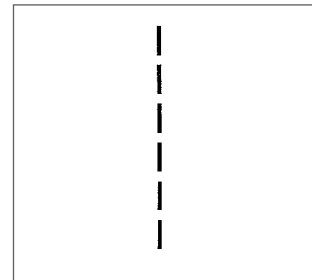

1. Select the Straight Stitch #01 and engage the Needle Stop Down function.
2. Place the stabilizer on the wrong side of the fabric.
3. Sew a line of stitching, and stop with the needle down in the fabric.
4. Raise the presser foot and pivot to turn a corner.
5. Lower the presser foot and continue sewing, pivoting to form at least 2-4 corners.

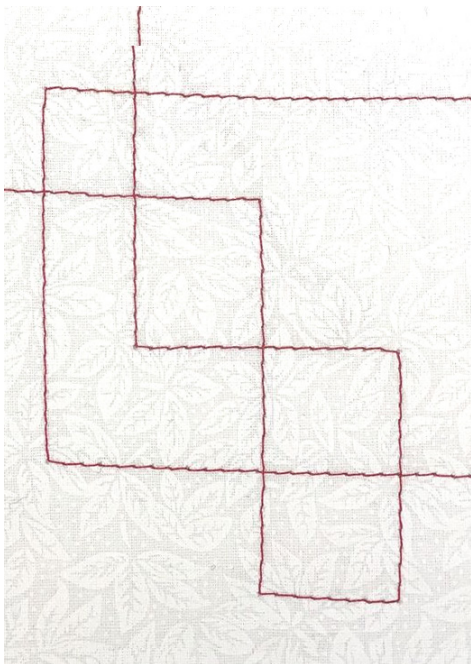

To Access Needle Stop Up/Down







Push the button on the front of the machine. If the needle is in the Stop Up position, it will change to Stop Down and vice versa.

Sew HOW

Do you know how to:

- Raise the presser foot of the machine?
- Pivot to form a stitched corner?

Zigzag Stitch

-  Firm woven fabric, 4" x 6"
-  80/12 Universal
-  As directed in instructions
-  Zigzag Foot A

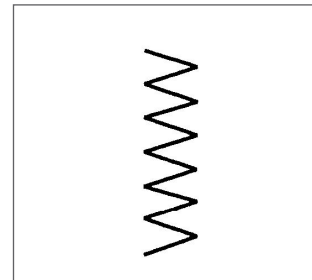

1. Select the Zigzag Stitch #5 (width = 4, length = 2).
2. Finish one 6" edge using the following steps.
3. Align the edge of the fabric with inner toe of presser foot so stitch falls on edge of the fabric.
4. Sew using the inside edge of the right toe as a guide.
5. The needle should go into the fabric on one stroke of the needle and over the edge on the next stroke.



Notes:

The zigzag stitch makes a good finish for raw edges.

Do not use too long a stitch or too wide a stitch; the edge should lie flat, not roll.

Match the weight of the thread to the weight of the fabric for best results.

Sew HOW

Do you know how to:

- Adjust the stitch width?
- Adjust the stitch length?

Blind Hem

-  Heavy flannel, 6" x 7"
-  80/12 Universal
-  As programmed
-  Zigzag Foot
Blindstitch Foot

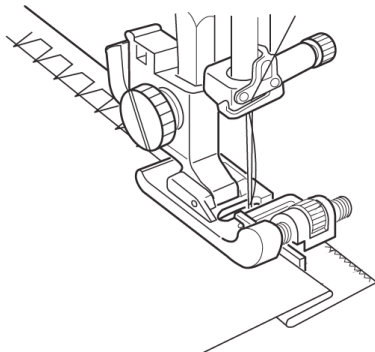
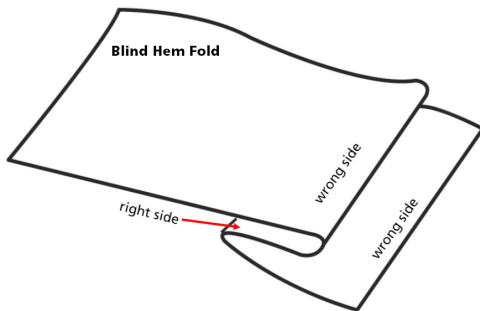
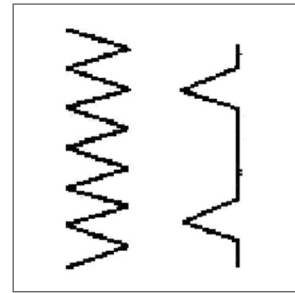





1. Attach the Zigzag Foot to the machine.
2. Finish one 6" edge of the fabric using a zigzag stitch, guiding the edge of fabric under the center of the foot. The needle should go into the fabric on one stroke of the needle and over the edge on the next stroke.
Note: *This is the same as the exercise on page 11.*
3. Fold a 2" hem to wrong side of fabric and press.
4. Baste the hem in place, sewing about 1/4" from the upper edge of the hem (the one previously stitched).
5. Select the Blindstitch and attach Blindstitch Foot G to the machine.
6. Fold the hem back to the right side over the basting line, exposing the zigzagged edge of the fabric.
7. Place the folded fabric under the foot and position it so the needle sews on the extended hem allowance, barely stitching into the fold of the hem as it swings over.
8. Use the screw on the side of the foot to adjust the guide if needed so that it is next to the fold of the hem.
9. Sew the hem, keeping the fold of the fabric next to the guide.
10. Unfold the fabric when finished, and notice that the stitches barely show on the outside of the fabric.

Sew HOW

Do you know how to:

- Do the blind hem fold?
- Adjust the guide on the Blindstitch Foot?

Triple Straight Stitch

-  Firm woven fabric, 4" x 6", two pieces
-  80/12 Universal
-  As directed in instructions
-  Zigzag Foot A

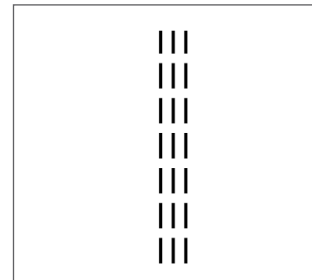

Triple Straight Stitch Seam

1. Attach the Zigzag Foot A to the machine.
2. Select the Triple Straight Stitch #03.
3. Place the fabric pieces right sides together.
4. Position the edge of the fabric along the 5/8" mark on the stitch plate.
5. Sew the seam and press it open.

Triple Straight Stitch Edgestitching

1. From the right side of the fabric, topstitch along one side of the seam line.
2. Sewing in the same direction as before, sew along the opposite side of the seam.

Notes:

The Triple Straight Stitch creates a very sturdy seam on items that receive a lot of wear. It also creates beautiful bold topstitching with regular weight thread that mimics the look of a heavier decorative topstitching thread.

Zigzag Foot A is useful when sewing thick fabrics or across bulky seams. Lower the needle into the fabric and then lower the foot while pushing in the black button to lock the foot in the horizontal position to avoid slipping. The button is released automatically after sewing a few stitches.







Sew HOW

Do you know how to:

- Use the stitch plate markings?
- Use the black button on the Foot A?

Vari-Overlock Stitch

-  Cotton interlock, 4" x 6", two pieces
-  80/12 Universal
(Ballpoint or Stretch may also be used)
-  As programmed
-  Overlock Foot C

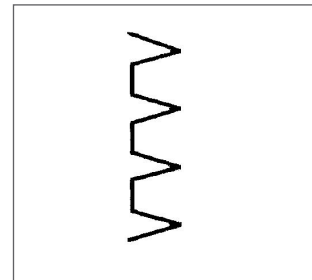

1. Attach Overlock Foot C to the machine.
2. Select Overlock Stitch (Stitch #11 on the b37 and #17 on the b38).
3. Engage the Needle Stop Down function if available.
4. Guide the raw edges of the fabric under the pin of the foot and stitch the two layers together. The stitch will form over the pin and the edge of the fabric.

Notes:

Using Overlock Foot C and the Overlock Stitch will keep the edge of the fabric flat, not rolled.

Other stitches that work with this presser foot are the Stretch Overlock Stitch and the Double Overlock Stitch.

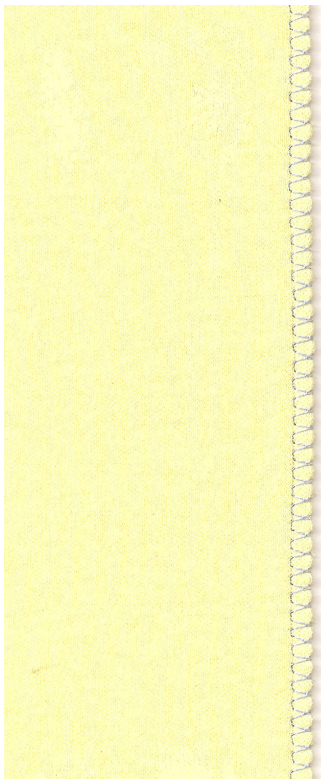





Sew HOW

Do you know how to:

- Engage the Needle Stop Down feature?
- Position Overlock Foot C?

Stretch Stitch

-  Spandex, 4" x 6", two pieces
-  80/12 Universal Ballpoint or Stretch may also be used
-  As programmed
-  Zigzag Foot A

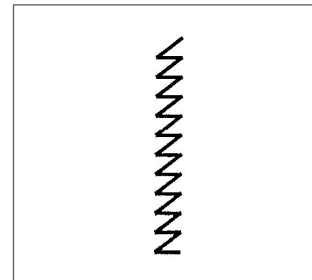

1. Attach Zigzag Foot A to the machine.
2. Select the Stretch Stitch (Stitch #04 on the b37 and #4, 04, or 12 on the b38).
3. Place the fabric pieces right sides together.
4. Position the edge of the fabric on the 5/8" marking on the stitch plate.
5. Sew the seam and press it open.

Notes:

This stitch is a narrow stretch stitch designed to eliminate puckering on knit fabrics and bias seams, while allowing the seam to be pressed completely open flat. If the fabric is pulling and stretching as it is sewn, adjust the presser foot pressure to a lower number to lighten the pressure of the foot on the fabric and eliminate the stretching.

Presser foot pressure adjustment is not available on the b37.







Sew HOW

Do you know how to:

- Adjust presser foot pressure on model b38?

1-Step Buttonholes

-  Heavy flannel, 7" x 6"
-  Lightweight tear-away stabilizer 7" x 6"
-  80/12 Universal
-  As programmed
-  Buttonhole Foot with Slide R

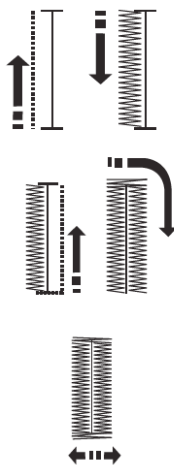
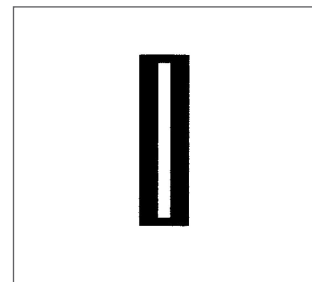







1. Fold flannel in half to 3.5" x 6" and press.
2. Insert stabilizer between the layers.
3. Mark buttonhole on fabric by drawing a line 1 1/2" from the fold along the 6" length. Mark the beginning point for each buttonhole along the drawn line.
4. Select the Standard buttonhole.
5. Press the needle stop up/down button to raise the needle.
6. Attach the Buttonhole Foot with Slide R.
7. Pull the button holder to the back, and place the button in it. Push it together tightly against the button.
8. Pull buttonhole lever down as far as it will go.
9. Insert the corner of the fabric under the foot. Press the needle stop up/down button twice. Remove the fabric to the left to draw the needle thread through the hole of the foot.
10. Place the fabric under the foot, and lower the needle at the starting point of the buttonhole mark.
11. Lower the Buttonhole Foot with Slide. Start to sew, keeping the foot control depressed until buttonhole is complete (it will stitch following the steps shown in the diagram to the left).

Sew HOW

Do you know how to:

- Select a buttonhole?
- Stitch a buttonhole?

Attaching Buttons

-  Firm woven fabric, 4" x 6"
 -  Lightweight tear-away stabilizer 4" x 6"
 -  80/12 Universal
 -  As needed
 -  Button Sew-On Foot T
 -  Feed dog lowered
- 3/4" (19 mm/30L) two-hole button**

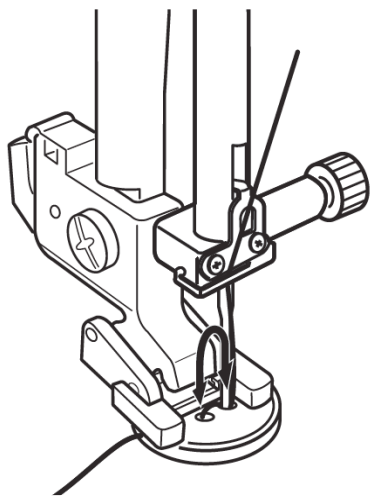
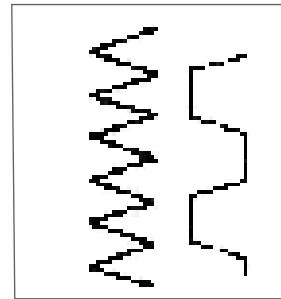

1. Attach the Button Sew-On Foot T to the machine and lower the feed dog, adjusting the speed to slow.
2. Select one of the following stitches:
Zigzag (Stitch #05 on the b37 and #5 or 05 on the b38)
Universal (Stitch #13 on the b 37 and #19 on the b38)
3. Place the stabilizer on the wrong side of the fabric.
4. Position fabric under the needle and place the button as desired. Lower the needle into one hole.
5. Check the distance between the holes of the button by turning the hand wheel. Adjust the stitch width if necessary so that the left and right swings of the needle fall into the holes of the button. Hold the thread tails as you begin to sew.
6. Sew 6-8 stitches, and stop. Bring the thread tails to the wrong side of the fabric and knot them together; trim the excess thread.



Note:





Stitch bartacks to attach charms, snaps, hooks, eyes, and ribbons using the same technique described above.

Sew HOW

Do you know how to:

- Lower the feed dog?
- Use Foot T to sew a bartack?

Stitching Zippers

-  Firm woven fabric, 4" x 6", two pieces
-  80/12 Universal
-  As programmed
-  Zigzag Foot A and Zipper Foot E
4" to 7" neckline zipper

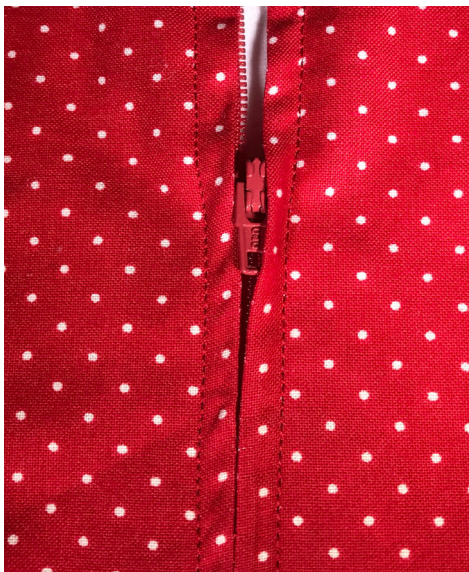
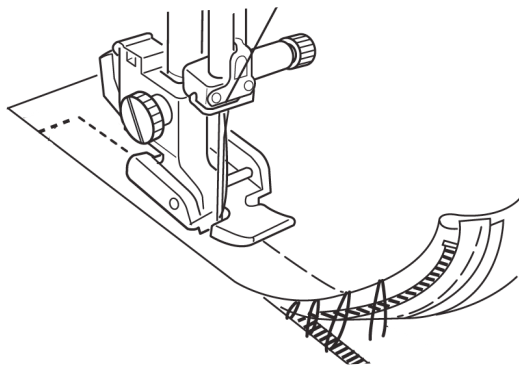
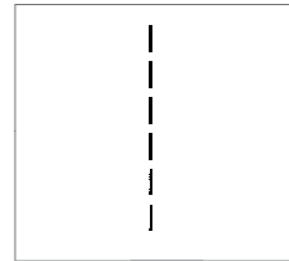

1. Attach Zigzag Foot A to the machine.
2. Place fabric pieces right side together.
3. Sew a straight stitch seam 3/4" from 6" edge:
 - Set stitch length at 2.5 mm. Start at one end and stitch for 2" (where zipper stop will be); backstitch to secure.
 - Change stitch length to a 4.0 mm stitch and baste the remainder of the seam.
 - Press seam allowances open.
4. Place the right side of the zipper against the seam allowances with the zipper teeth centered over the seam. Pin zipper to seam allowances only.
5. Attach Zipper Foot E to the machine. To sew the left-side of the zipper, attach the zipper foot with the right-hand side of the pin. To sew the right-side of the zipper, attach the zipper foot with the left-hand side of the pin.
6. Return the stitch length to 2.5 mm. Stitch close to the zipper teeth, sewing through the zipper tape and the seam allowance only, from bottom to top on each side of the zipper.
7. From the right side of the garment, pin through all layers to hold the sewn zipper to the project.
8. Sewing from the right side and starting from the bottom seam of the zipper:
 - Stitch from the seam out to one side.
 - Stop 3/8" from seam and pivot; stitch to the top.
 - Starting from the bottom, repeat on the opposite side
9. Remove the basting stitches.

Sew HOW

Do you know how to:

- Machine baste a seam?

Decorative Stitching

Decorative Stitching and Embellishment Techniques

As you begin to experiment with decorative stitches there are several things you should keep in mind:

- Type of thread you plan to use
- Presser foot you select
- How you prepare your fabric

Type of Thread

Selecting the thread for decorative stitching often comes down to a personal preference and what looks best on your project.

Cotton embroidery thread, especially in a heavier weight such as 30, gives a beautiful look to the stitches and has a nice luster to it.

If you want a high sheen, rayon or polyester embroidery thread are good choices.

Presser Foot

The presser foot you select is critical for good results because it can affect the way the fabric feeds under the needle, influencing the stitch formation.

Usually the key to selecting the correct presser foot is the sole. Stitches that are more open and have less thread will stitch well with an all-purpose presser foot such as Zigzag Presser Foot A.



When creating heavy, satin stitched patterns, you will need a foot that is not flat on the bottom. It should have some type of indentation that allows the foot to ride over the completed stitch without dragging or inhibiting the feed of the fabric. Satin Stitch Foot F and Open Toe Foot F2 are designed for this purpose.

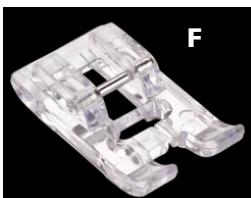

Preparing the fabric

Preparing your fabric correctly can take the frustration out of stitching, giving you a positive experience with beautiful results. The fabric needs to be stable enough to support the stitching without tunneling or puckering. This can be accomplished in several ways, sometimes with a combination of techniques:

- The fabric itself might be heavy enough to support the stitching.
- Interfacing (fusible or sew-in) can be applied to the wrong side of the fabric and left in the project.
- Stabilizers are used as a temporary form of support.

Additional Functions

The following function may be useful when working with decorative stitches.

Auto Lock (b37 and b38)

Easily tie off the beginning and end of decorative stitches without spoiling the look of the pattern. Press the Auto-Lock button on the front of the machine. The machine will finish the current pattern, take a series of short stitches, and automatically stop.







Needle Stop Down (b38)

Enter setting mode by pressing and holding the mem button while turning the power switch on; the setting mode screen appears. Press mode button to enter the up/down needle position setting. The default up/down needle position setting is "DN". To change the needle position, press the cursor. The "UP" mark will blink. Press memory button to change the up/down needle position to "UP".

Mirror Image (b38)

Press the Mirror Image button on the front of the machine. Pattern will stitch horizontally reversed. This feature can also be used with the memory function.

Satin Stitching

-  Firm woven fabric, 4" x 6"
-  Lightweight tear-away stabilizer 4" x 6"
-  80/12 Universal
-  Cotton or polyester embroidery thread
-  As indicated in directions
-  Satin Stitch Foot F or Open Toe Foot F2

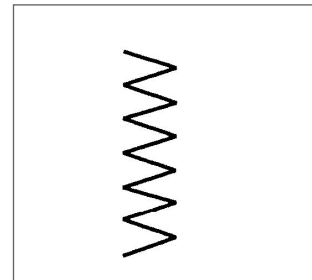

1. Attach Satin Stitch Foot F or F2 to the machine. If neither of these feet is available, use Zigzag Foot A and set the stitch length slightly longer for a slightly more open stitch.
2. Place the stabilizer behind the fabric.
3. Select the Zigzag Stitch.
4. Adjust the stitch length to satin stitch (0.5mm) and the stitch width to 5-7 mm.
5. Stitch a line of satin stitching. This stitch is used as a fill stitch, for decorative edgings, and to stitch applique shapes to a background fabric.
6. Check the tension of the stitch; the needle thread should fall slightly to the wrong side of the fabric so that the bobbin thread does not show on the right side of the fabric. If needed, loosen the needle tension slightly to pull the thread to the wrong side.
7. Continue stitching while altering the stitch width for tapered effects.









Sew HOW

Do you know how to:

- Adjust the settings for satin stitching?
- Taper and widen the satin stitch?

Stitch Combinations/Memory

-  Firm woven fabric, 4" x 6"
-  Lightweight tear-away stabilizer 4" x 6"
-  80/12 Universal
-  30 wt. cotton embroidery thread
-  Default
-  Satin Stitch Foot F or Open Toe Foot F2

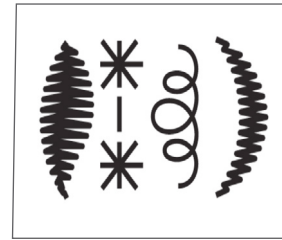

Preparation

1. Attach Satin Stitch Foot F or F2 to the machine.
2. Place the stabilizer behind the fabric.
3. Follow the directions to the right to sew a stitch combination using your bernette model.



Model b37

1. Select Stitch #44.
2. Sew pattern #44 and press the auto-lock button while sewing the second unit. The machine will stop automatically when the second unit is completed.
3. Select stitch pattern #41. Start sewing, then press the auto-lock button. Machine will stop automatically at the end of one pattern. Repeat step #2 to sew two patterns of stitch #44 and stop automatically.

Model b38 (Memory)







1. Select Mode 3, Stitch #39; press mem one time.
2. Select Mode 3, Stitch #38; press mem one time.
3. Select Mode 3, Stitch #39; press mem one time.
4. Begin sewing; the machine will finish the pattern, tie off the stitch, and automatically stop. Press clr.
5. Select Mode 3, Stitch #57; press mem one time.
6. Select Mode 3, Stitch #57 and touch Mirror Image; press mem one time.
7. Begin sewing; the machine will finish the pattern, tie off the stitch, and automatically stop.

Sew HOW

Do you know how to:

- Combine stitches on your machine?
- Access the memory and stitch combined stitches from your machine's memory?

Alphabets

-  Firm woven fabric, 4" x 6"
-  Lightweight tear-away stabilizer 4" x 6"
-  80/12 Universal
-  Cotton or Polyester embroidery thread
-  Default
-  Satin Stitch Foot F or F2



For Model b 38

Mode 4: Alphabets/number/symbol

Mode 5: European accented letters

Mode 6: Russian (Cyrillic) letters

Viewing Text

Press the right cursor scroll arrow to scroll to the right; press the left cursor scroll arrow to scroll to the left.

Deleting and Inserting Letters

1. Press the cursor scroll arrow to move it under the letter to be deleted.
2. Press the clear button.
3. Select the desired letter.
4. Press the mem button to program the new letter.



Upper Case Letters

1. Attach Satin Stitch Foot F or F2.
2. Place the stabilizer behind the fabric.
3. Select Mode 4 and press 11 for the upper case A.
4. Press the mem button to program the A.
5. Select and program letters B (#12) and C (#13).

Lower Case Letters

1. Select Mode 4 and press 38 for the lower case b.
2. Press the mem button to program the b.
3. Continue selecting letters e-r-n-e-t-t-e to spell the word "bernette", pressing the mem button after each selection. Note: Select the "t" one time but press the mem button twice to program two of them into memory.

Numerals







1. Select Mode 4 and press 01 for the numeral 1.
2. Press the mem button to program the 1.
3. Select and program numbers 2 through 5 (#02-05).
4. Position the fabric/stabilizer under the foot and stitch; the machine will stop and the needle will be in the up position when it reaches the end of the programmed word(s).

Sew HOW

Do you know how to:

- Program lettering into the memory of your machine?
- Edit lettering already programmed?

Double Needle Stitching

-  Firm woven fabric, 4" x 6"
-  Lightweight tear-away stabilizer 4" x 6"
-  2.0 mm or 3.0mm Double Needle
-  Two spools of cotton or polyester embroidery thread
-  Center
-  Satin Stitch Foot F or Open Toe Foot F2

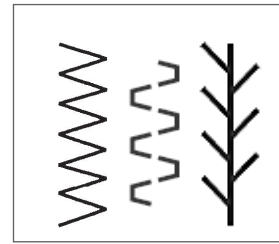

assorted stitches

Double Needles are available in sizes: **1.6/70 to 8.0/100**
 Note: Do not use a twin needle with spacing wider than the maximum stitch width of the machine,

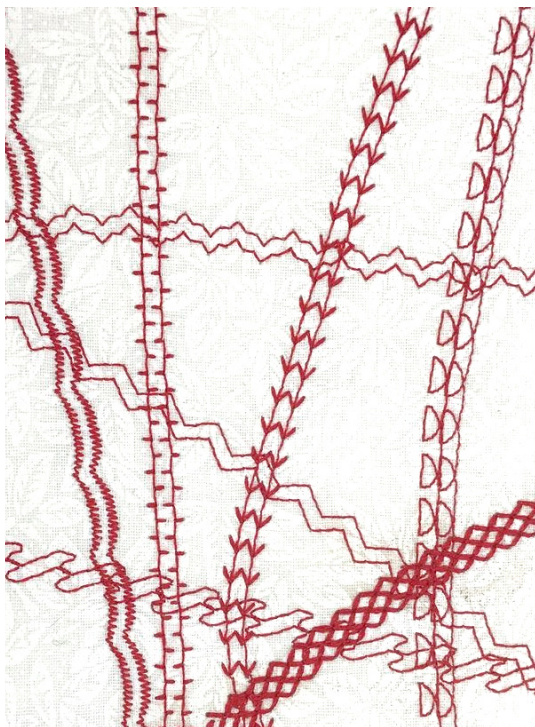

1. Attach Satin Stitch Foot F or Open Toe Foot F2 to the machine.
2. Place the stabilizer behind the fabric.
3. Insert the Double Needle into the machine with the flat side to the back; attach accessory spool pin to machine.
4. Thread the machine with 2 spools of thread following the normal thread path. When you reach the needle, there is a thread guide on each side of the needle. place one thread in the right guide and one in the left.
5. Carefully check the stitch width before sewing to avoid breaking the needles; turn the handwheel to walk the machine through the first stitch.
6. Select several different stitches and sew across the fabric as desired.

Double Needle Tips

- When doing decorative needle work, sew slowly – change motor to half speed if this option is available.
- Use this formula to determine the widest stitch width possible before the needle strikes the presser foot:
Widest width of the machine minus the width between the two needles = widest stitch width possible.
- Model b38 has a Twin Needle button on the front of the machine. When sewing with a double needle, press the button. The machine will restrict the width of the selected stitch automatically to prevent needle breakage.



Sew HOW

Do you know how to:

- Insert a Double Needle?
- Thread the machine for Double Needle sewing?

SUPPLIES

FABRICS

Q.	FABRIC TYPE	SIZE	EXERCISES	EXAMPLES
13	Firm woven	4" x 6"	Securing Stitches, pg. 9 Turning Corners, pg. 10 Zigzag Stitch, pg. 11 Triple Straight Stitch, pg. 13 Attaching Buttons, pg. 17 Stitching Zippers, pg. 18 Satin Stitching, pg. 20 Stitch Combinations/Memory, pg.21 Alphabets, pg. 22 Double Needle Stitching, pg. 23	Heavy muslin High-quality quilting cotton Medium weight denim
2	Heavy Flannel	7" x 6"	Blind Hem, pg. 12 Buttonholes, pg. 16	Wool flannel Brushed denim
2	Cotton Interlock	4" x 6"	Overlock Stitch, pg. 14	T-shirt knit
2	Spandex	2" x 6"	Stretch Stitch, pg. 15	Lycra







NOTIONS & ACCESSORIES

NOTION OR ACCESSORY	EXERCISES
One piece of lightweight tear-away stabilizer, 7" x 6"	Buttonholes, pg. 16
Six pieces of lightweight tear-away stabilizer, 4" x 6"	Turning Corners, pg. 10 Attaching Buttons, pg. 17 Satin Stitching, pg. 20 Stitch Combinations/Memory, pg. 21 Alphabets, pg. 22 Double Needle Stitching, pg. 23
Optional: Buttonhole Cutter and Block	Buttonholes, pg. 16
4"-7" neckline zipper	Stitching Zippers, pg. 18

NEEDLES & THREADS

80/12 Universal (Ballpoint may be used for knit fabrics)	For all stitch exercises except Double Needle Stitching, pg. 23
Double Needle, size 2.0 mm or 3.0 mm	Double Needle Stitching, pg. 22
Cotton or polyester embroidery thread	For all stitch exercises

SEWING FUNCTIONS

	Auto-lock button		Needle Stop Up/Down button
	Reverse Sewing button		Start/Stop button
	Cursor buttons (< >)		Value Set buttons (^ v)

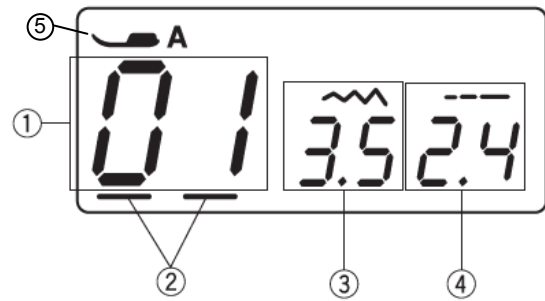

LCD DISPLAY

1	Stitch Pattern Number	4	Stitch Length
2	Cursors	5	Presser Foot
3	Stitch Width		

STITCH CHART

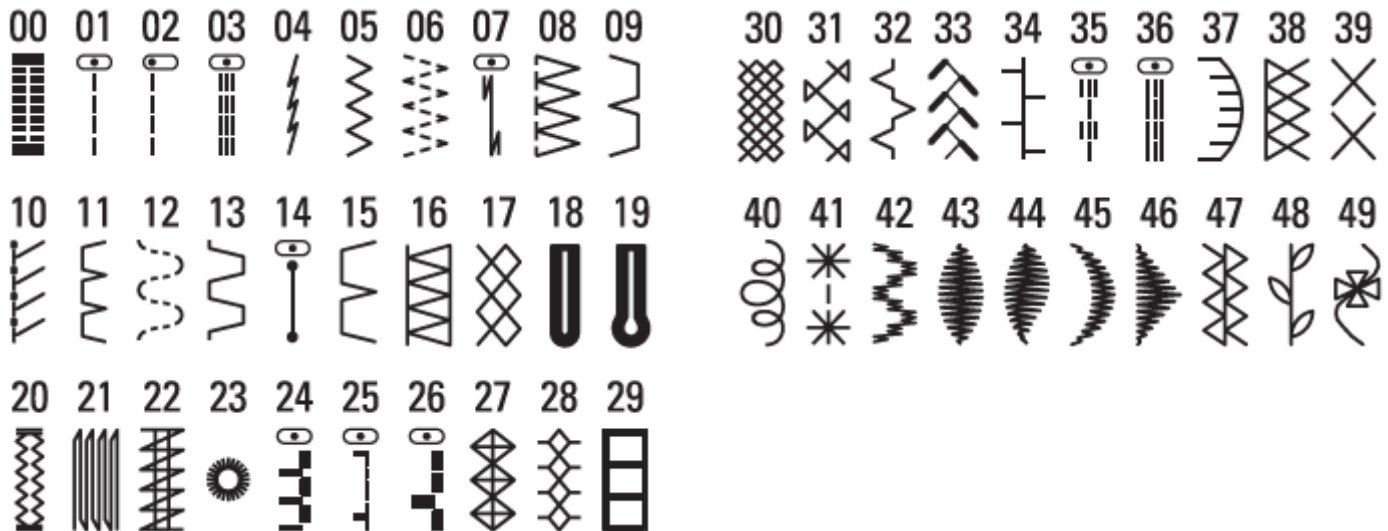

bernette 37 Accessories

5 Presser Feet:

One shank + 5 snap-on soles:

- Zigzag Foot (A)
- Satin Stitch Foot (F)
- Buttonhole Foot with Slide (R)
- Zipper Foot (E)
- Button-sew-on Foot (T)

Additional Accessories:

- Manual
- 4 Bobbins
- 1 pkg. Assorted Needles
- Small Spool Disc
- Large Spool Disc
- Spool Pin Felt
- Second Spool Pin
- Seam Ripper

- Spool Net
- Lint Brush
- Dust Cover

Optional:

- Large Extension Table

WARRANTY

- 10 years Mechanical
- 2 years Electrical
- 2 years Electronic

SEWING FUNCTIONS

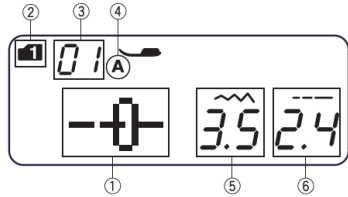

LCD DISPLAY

1	Stitch Pattern	4	Presser Foot
2	Mode	5	Stitch Width
3	Stitch Pattern Number	6	Stitch Length

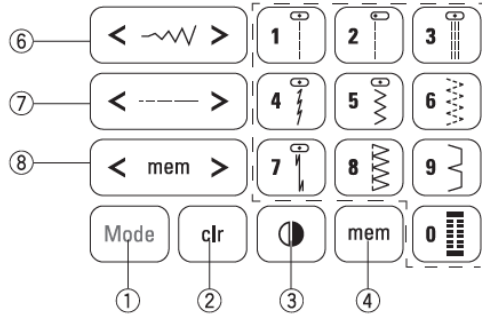

TOUCH PANEL

1	Mode button	5	Number buttons
2	Clear button	6	Stitch Width button
3	Mirror Image button	7	Stitch Length button
4	Memory Button	8	Cursor



Needle Stop Up/Down
Thread Cutter button
Twin Needle button
Slide Speed Control

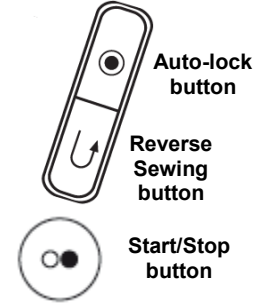

Auto-lock button
Reverse Sewing button
Start/Stop button

STITCH CHARTS

MODE 2

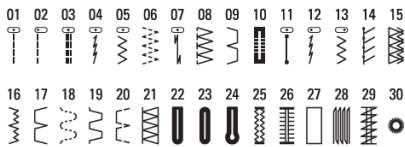

MODE 3

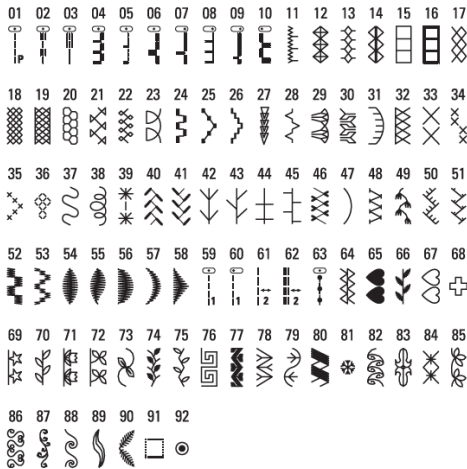

MODE 4

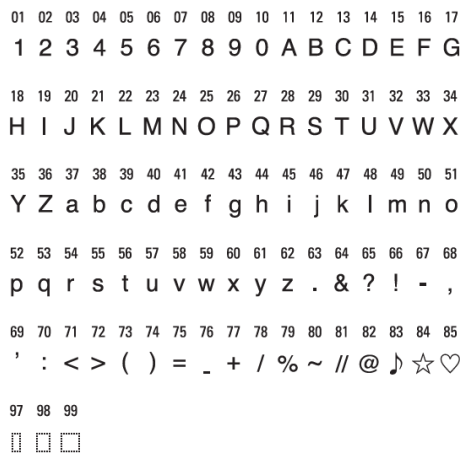

MODE 5



MODE 6



8 Presser Feet:

One shank + 8 snap-on soles:

- Zigzag Foot (A)
- Overlock Foot (C)
- Zipper Foot (E)
- Satin Stitch Foot (F)
- Blindstitch Foot (G)
- Button-sew-on Foot (T)
- Open Toe Foot (F2)
- Buttonhole Foot with Slide (R)

bernette 38 Accessories

Additional Accessories:

- Manual
- 4 Bobbins
- 1 pkg. Assorted Needles
- 3 Large Spool Discs
- 2 Small Spool Discs
- Second Spool Pin
- Seam Ripper
- Spool Net

- Lint Brush
- Screwdriver
- Hard Cover
- Large Extension Table

WARRANTY

- 10 years Mechanical
- 2 years Electrical
- 2 years Electronic