

# MY BERNINA

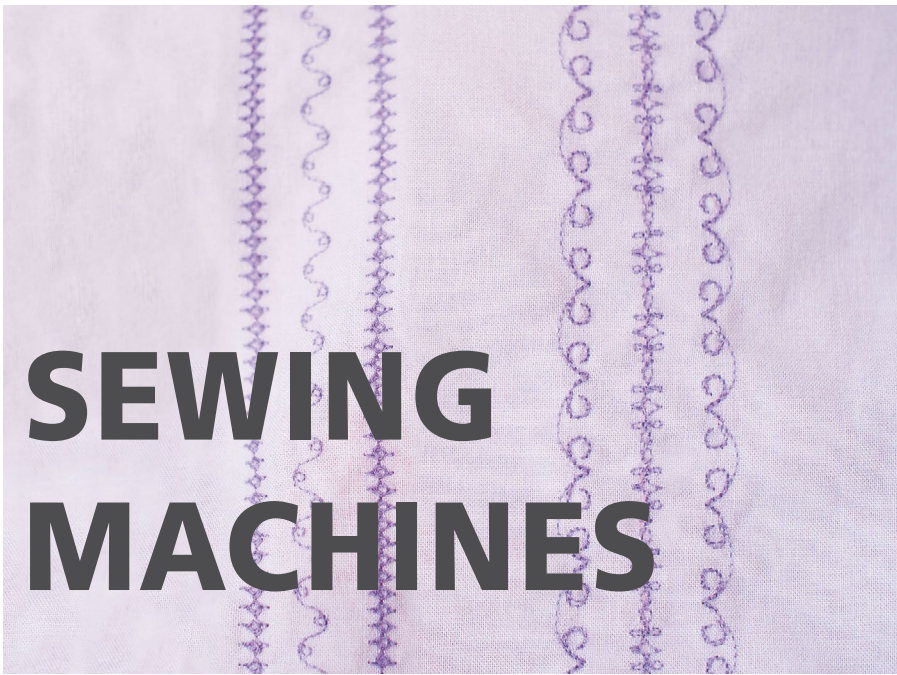

# SEWING MACHINES

**BERNINA SEWING MACHINE WORKBOOK**  
For BERNINA 335, 325, 215

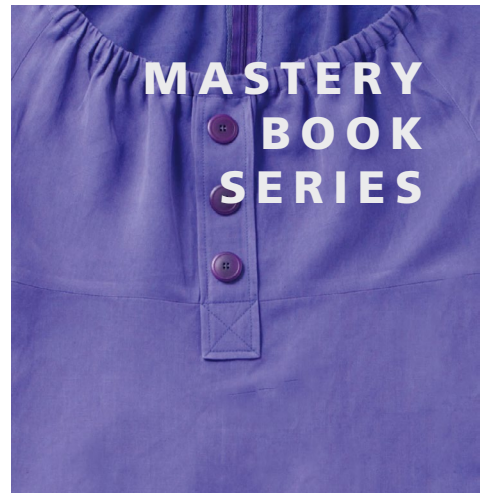

made to create **BERNINA**

# TABLE OF CONTENTS

---

INTRODUCTION .....	3	REFERENCE - SEWING MACHINE NEEDLES..	26
PREPARING TO STITCH .....	4	REFERENCE - SEWING MACHINE NEEDLE	
STITCH SELECTION.....	5	CHART .....	27
NEEDLE STOP UP/DOWN-FREE HAND		REFERENCE - THREADS.....	28
SYSTEM .....	6	REFERENCE - DECORATIVE STITCHING ....	29
PATTERN FUNCTIONS - PATTERN END.....	7	REFERENCE - CLEANING AND OILING .....	30
ALTERED STITCHES .....	8		
TEMPORARY ALTERED MEMORY .....	9		
MIRROR IMAGE - LEFT/RIGHT .....	10		
TRIPLE STRAIGHT STITCH .....	11		
VARI-OVERLOCK STITCH .....	12		
BASTING STITCH .....	13		
BLIND HEM .....	14		
STRETCH STITCH .....	15		
BALANCE.....	16		
MANUAL BUTTONHOLES.....	17		
AUTOMATIC BUTTONHOLE PROGRAM ..	18		
MEMORY BUTTONHOLES .....	19		
ATTACHING BUTTONS.....	20		
STITCHING ZIPPERS.....	21		
COMBINING STITCH PATTERNS.....	22		
PROGRAMMING ALPHABETS AND			
NUMBERS.....	23		
FREE-MOTION STITCHING .....	24		
REFERENCE - BERNINA PRESSER FEET .....	25		

**B 335**



**B 325**



**B 215**



The information in this workbook applies to the BERNINA Sewing Machines models shown here.

**NOTE:** Some exercises apply only to certain models equipped with the feature being highlighted.

# INTRODUCTION

Welcome! Learning to use your new machine to its fullest capabilities will let you enjoy your machine for many years. Understanding your machine's features and learning its navigation will maximize your creativity. While you will be learning some basics, you'll also be learning some creative techniques, and we hope both will be inspirational.

Along with your machine's manual, this workbook is designed to take you on a step by step journey into your machine's capabilities. Once completed, the workbook can serve as a technique reference guide.

Stitched samples can be attached to the pages or inserted into sheet protectors, if desired. You will find additional resource materials in the back of this workbook.

While this may be the beginning of your educational journey, there are other opportunities to grow creatively. BERNINA of America strives to provide quality sewing and embroidery machines while offering the best educational experience possible. Along with providing My BERNINA Classes, your local BERNINA dealer stocks BERNINA reference books, such as the Big Book of Feet.

Instructional video tutorials are available on [bernina.com](http://bernina.com) and the BERNINA YouTube channel. You will also find inspiring sewing projects on the BERNINA blog [WeAllSew.com](http://WeAllSew.com). For more information about machines and accessories, visit the BERNINA website at [bernina.com](http://bernina.com).

[www.bernina.com](http://www.bernina.com)  
[www.weallsew.com](http://www.weallsew.com)



# PREPARING TO STITCH

## CLEANING AND OILING

Keeping your machine clean and well oiled will keep it running smoothly and is a crucial component for successful machine stitching. Refer to Page 30 for cleaning tips. Your machine manual will also give you detailed cleaning and oiling suggestions.

## STITCH PLATE

Attach the 5.5 mm Stitch Plate: Standard accessory for B 335, 325, 215

## PRESSER FOOT

- Attach the shank with Reverse Pattern Sole #1 to the machine. (Refer to Page 25 Reference-BERNINA Presser Foot for more information about BERNINA Presser Feet.)

## RAISE FEED DOG

The feed dog will be raised when sewing.

## INSERT AND THREAD NEEDLE (Refer to Page 26-27 Reference-Threads for additional information.)

- Use the proper needle for the thread and fabric being used. It is advisable to insert a new needle for each project, or after every 8 hours of sewing time.
- Always thread with the presser foot up. This opens the tension discs and allows the thread to seat properly.

## THREADING TIPS FOR MODELS WITH BOTH HORIZONTAL AND VERTICAL SPOOL PINS:

- Use the horizontal spool pin with cross-wound threads; match spool cap size to end of spool.
- The smallest spool cap fits into the end of large cones/spools such as Isacord embroidery thread.
- Use the vertical spool pin with stacked threads and for some decorative threads (metallic threads); use the foam disc under the spool to avoid extra tension on the thread.

## THREAD THE BOBBIN FOR SEWING

- Generally, you will wind the bobbin with the same thread/thread weight that you will use in the needle.
- Open the bobbin cover and grasp the latch of the bobbin case. Remove the bobbin case.
- Insert the newly wound bobbin into the bobbin case so that the thread runs clockwise. Pull the thread counterclockwise into the slot. Then pull the thread to the left under the spring until it lies in the T-shaped slit at the end of the spring. The bobbin must turn clockwise.

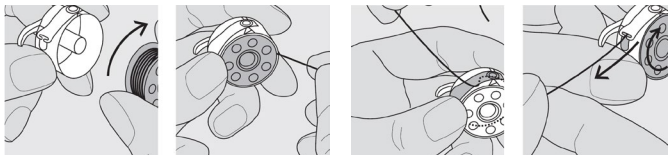

- To insert the bobbin case, hold the bobbin case latch. The finger on the case should point upwards. Insert the case so that it clicks into place. Pull the thread over cutter A and cut. Close the bobbin door. NOTE: The bobbin thread does not have to be brought up as the loose end is the right length to start sewing if you have cut the thread with the cutter.

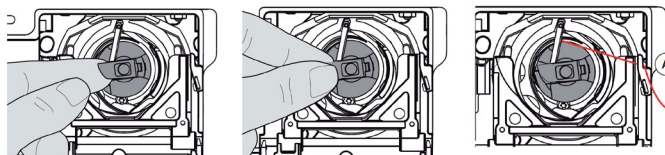



# STITCH SELECTION

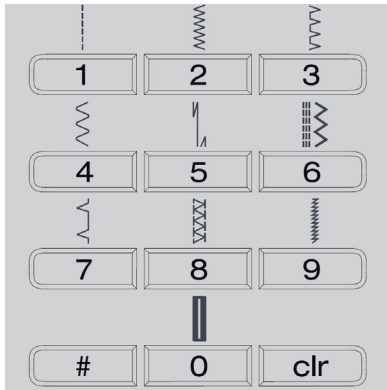

## Selecting a Stitch - B 335, 325

1. For stitch patterns 1 through 10:
  - Press the numbered button of your choice; stitch number and default width and length settings appear, as well as the recommended presser foot.
  - Press 0 to select Stitch Number 10 (standard buttonhole).
2. For stitch patterns 1-99 (B 335) / 1-40 (B325):
  - Press the # button and enter desired stitch number.
3. For stitch patterns 100 and beyond (B 335):
  - Press # button twice and enter desired stitch number.

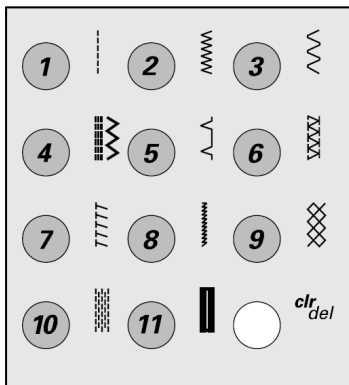

## Selecting a Stitch - B 215



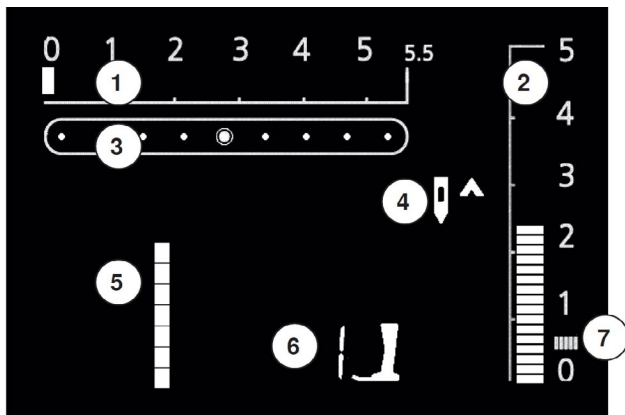

1. For stitch patterns 1 through 11:
  - Touch the numbered button of your choice; stitch number and default width and length settings appear on the LCD Display, as well as the recommended presser foot.

## Details of the Screen

- (1) Stitch width (basic setting always visible - blinks)
- (2) Stitch length (basic setting always visible - blinks)
- (3) Needle Position (9 positions)
- (4) Needle Stop Up/Down Display
- (5) Stitch Pattern Number
- (6) Recommended presser foot for selected stitch
- (7) Satin stitch recommendation for dense, short zig-zag stitch



# NEEDLE STOP UP/DOWN-FREE HAND SYSTEM

-  Firm woven fabric, 4" x 6", two pieces
-  80/12 Universal
-  Polyester or cotton embroidery thread
-  Center
-  Reverse Pattern Sole #1

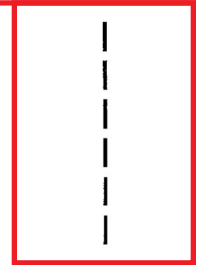

NOTE: The BERNINA foot control is an optional accessory for the B 335, 325, and 215. A tap of the toe will make the needle take one full revolution. A heel tap will raise or lower the needle.

The Free Hand System is an optional accessory for the B 335 only.

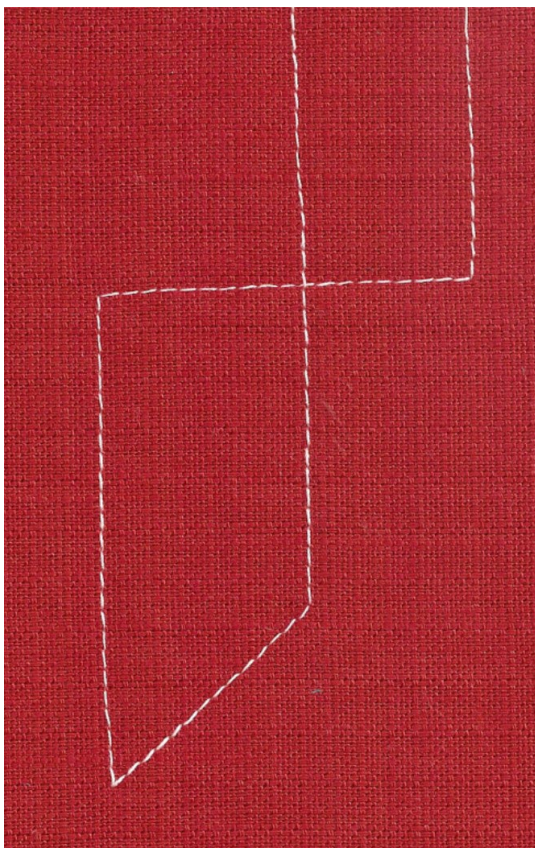







1. Attach Reverse Pattern Sole #1.
2. Select the Straight Stitch #1.
3. Touch the Needle Up/Down Button on the machine. Each push of the button will set the Needle to stop in the Up position or in the Down position as noted on the screen.
  - This setting remains until changed, even if the machine is turned off.
4. To lower or raise the needle, press and hold the Needle Up/Down button. The needle will raise and lower. This does not affect the Needle Up/Down setting.
5. Sew a line of stitching and stop in the middle of the fabric.
6. Raise the Take Up Lever and pivot to form at least 2 right angle corners and 2 additional corners.
  - When pivoting, use the FHS (Free Hand System - optional accessory for B 335 only) to raise the presser foot.

## Sew HOW

Do you know how to:

- Raise and lower the needle without using the handwheel?
- Set the needle to always stop in the down position?

# PATTERN FUNCTIONS - PATTERN END

-  Firm woven fabric, 4" x 6"
-  Lightweight tear-away stabilizer 4" x 6"
-  80/12 Universal
-  Polyester or cotton embroidery thread
-  Default
-  Open Embroidery Sole #20

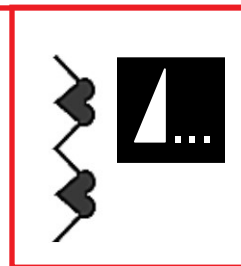

**NOTE:** Refer to Page 29 Reference-Decorative Stitching for more tips for decorative stitching.

## For B 335 and 325 ONLY

1. Attach Open Embroidery Sole #20.
2. Place the stabilizer behind the fabric.
3. Select the satin stitch hearts stitch #25 (B 325) or #44 (B 335).
4. Sew 3½ patterns, pausing in the middle of the fourth pattern.
5. Press Pattern End and start sewing again. The machine will stop stitching when the pattern is complete.
  - **Tip:** To make sure you have a complete pattern, depress the foot control and do not lift your foot until the machine stops.
6. Press clr.









## Sew HOW

Do you know how to:

- Stitch a complete pattern?

# ALTERED STITCHES

-  Firm woven fabric, 4" x 6"
-  Lightweight tear-away stabilizer 4" x 6"
-  80/12 Universal
-  Polyester or cotton embroidery thread
-  Default
-  Open Embroidery Sole #20

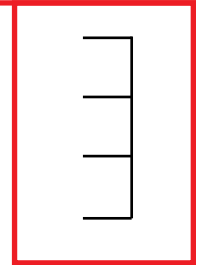

### Instructions Below for B 335 and 325 ONLY

**B 215:** Pick any stitch (#2 through #9) and experiment with the length and width settings.

1. Attach Open Embroidery Sole #20.
2. Place the stabilizer behind the fabric.
3. Select Blanket Stitch (B 325 #39, B 335 #107, B 215 use Blind Stitch #5).
4. Sew a row of stitches.
5. Adjust stitch width to 3.5 mm and stitch length to 4.1 mm. Sew a second row of stitching next to the first.
6. Change the stitch length back to its default setting.
7. Sew a third row of stitching next to the previously sewn rows.

Programmed settings	3.5 mm width 4.1 mm length	3.5 mm width Default length
------------------------	-------------------------------	--------------------------------

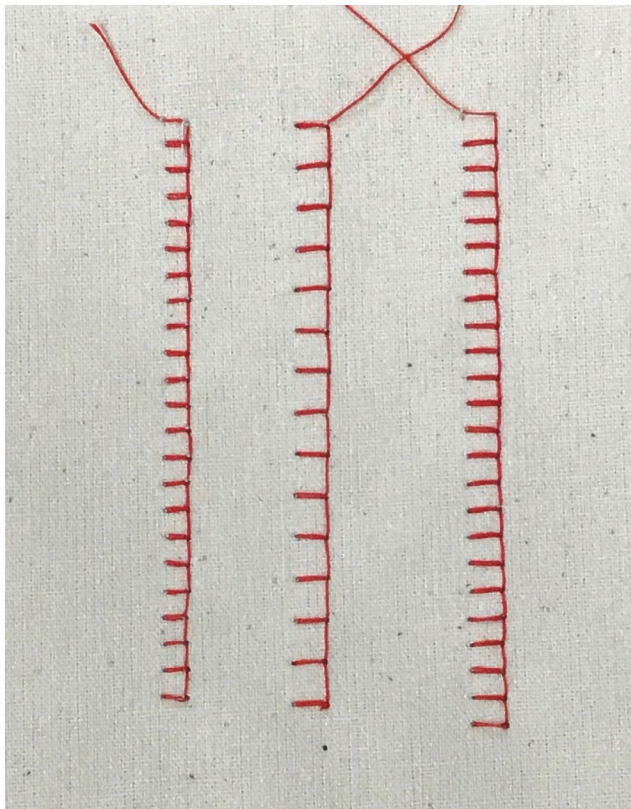

NOTE: Stitch width and length can be altered while sewing.

## Sew HOW

Do you know how to:

- Access stitches on your model?
- Reset the stitch length and width to the preprogrammed settings?



# TEMPORARY ALTERED MEMORY







---

Temporary Altered Memory is an exclusive feature of BERNINA sewing machines. The machine will remember the last alterations made to any stitch. These alterations will remain in effect until manually changed, until clr is touched, or until the power to the machine is turned off.

1. Select Zigzag Stitch #2. Change the width of the stitch to 4.5. Change the stitch length to 1.
2. Select Stitch #1.
3. Select Zigzag Stitch #2 again. Notice that the stitch has retained the altered settings automatically.

*NOTE: Individual stitch patterns can be reverted to basic settings manually. All altered settings are lost when the clr button is pressed or when the sewing machine is turned off.*

# MIRROR IMAGE - LEFT/RIGHT

-  Firm woven fabric, 4" x 6"
-  Lightweight tear-away stabilizer 4" x 6"
-  80/12 Universal
-  Polyester or cotton embroidery thread
-  Default
-  Open Embroidery Sole #20



### Horizontal Mirror Image (Left/Right):

- Machine sews selected stitch in Horizontal Mirror Image.
- Right/left is determined by the sewing direction.

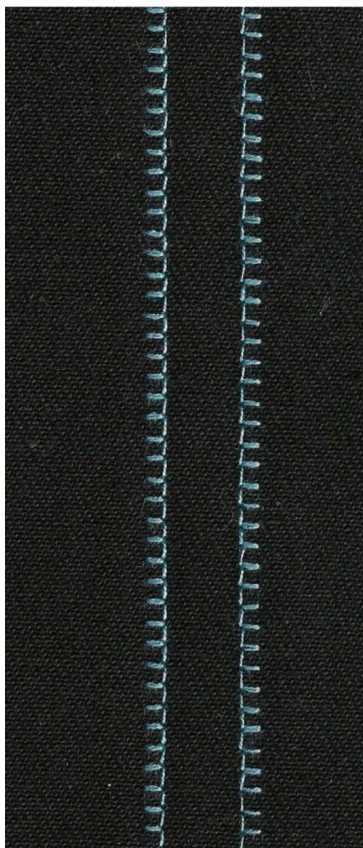

### For B 335 ONLY

1. Attach Open Embroidery Sole #20.
2. Place stabilizer behind fabric.

### Left/Right Mirror Image:

1. Select the Blanket Stitch #107.
2. Sew one row down length of fabric.
3. Engage Left/Right Mirror Image and sew a second row next to the first, using the side of the presser foot for spacing.

## Sew HOW

Do you know how to:

- Activate Mirror Image?

# TRIPLE STRAIGHT STITCH

 Firm woven fabric, 4" x 6", two pieces

 80/12 Universal (for best results use a Topstitch Needle to prevent looping)

 Polyester or cotton embroidery thread

 As directed in instructions

Reverse Pattern Sole #1

 Full Shank Edgestitch Foot #10 (optional accessory)

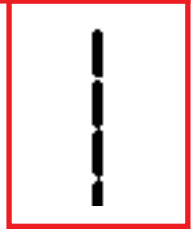

## Notes:

The Triple Straight Stitch creates a very sturdy seam on items that will receive a lot of wear.

It also creates beautiful bold topstitching with regular weight thread that mimics the look of a heavier decorative topstitching thread and a topstitch needle.



## Triple Straight Stitch Seam

Triple Straight Stitch available only on B 335 and 325

1. Attach Reverse Pattern Sole #1.
2. Select the Triple Straight Stitch #6 (B 335 and 325 ONLY). B 215 may wish select Straight Stitch #1, but note that stitch will not look the same.
3. Place the fabric pieces right sides together.
4. Position the edge of the fabric along the 5/8" mark on the stitch plate.
5. Sew the seam and press it open.

## Triple Straight Stitch Topstitching

1. Change to optional Edgestitch Foot #10 and adjust the needle position to the far right.
  - Note: If Edgestitch Foot #10 is not used, use Reverse Pattern Sole #1. Place the edge of the sole along the seam line and adjust the needle position to the far left or far right.
  - Note: The B 215 could create a similar look of heavy topstitching by using a large needle and heavier thread.
2. With the right side of the fabric up and with the guide of the foot in the ditch of the seam, sew the length of the seam from top to bottom.
3. Adjust the needle position to the far left.
4. Stitch a second time with the guide of the foot in the ditch of the seam. Sew in the same direction as before.

## Sew HOW

Do you know how to:

- Adjust the needle position?
- Use the optional Edgestitch Foot #10?

# VARI-OVERLOCK STITCH

 Cotton interlock, 4" x 6", two pieces

 80/12 Universal  
(Ballpoint or Stretch may also be used)

 Polyester or cotton embroidery thread

 As programmed

 Overlock Sole #2

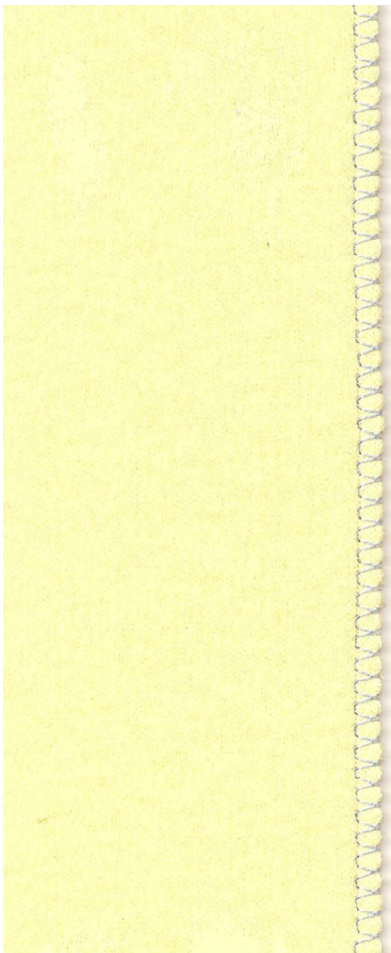
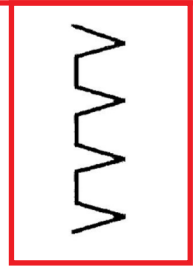

1. Attach Overlock Sole #2.
2. Select the Vari-Overlock Stitch #3 (B 335 and 325). B 215 select Stretch Overlock Stitch #7.
3. Engage the Needle Stop Down function.
4. Guide the raw edges of the fabric under the pin of the foot and stitch the two layers together. The stitch will form over the pin and the edge of the fabric.

**Notes:**

*Using the Overlock Foot and the Vari-Overlock Stitch will keep the edge of the fabric flat, not rolled.*

*Other stitches that work with this presser foot are the Stretch Overlock Stitch and the Double Overlock Stitch.*

## Sew HOW

Do you know how to:

- Engage the Needle Stop Down feature?
- Position Overlock Sole #2?



# BASTING STITCH

 Wool-like fabric or heavy flannel, 6" x 7"

 80/12 Universal

 Polyester or cotton sewing thread

 Default

 Reverse Pattern Sole #1

**NOTE:** This fabric sample will be used with the Blind Hem Exercise on the following page.



1. **Optional:** Finish one 6" edge of the fabric with a zigzag stitch, the Vari-Overlock Stitch, or an overlock machine.
2. Fold a 2" hem to the wrong side of the fabric and press.
3. Attach Reverse Pattern Sole #1.
4. Select the straight stitch. Touch clr to clear any previous changes to the stitch.
  - Increase the stitch length to 5 mm.
5. Baste the hem in place, sewing about 3/4" from the finished edge of the hem (if done in Step 1).
6. Press clr to return to a standard straight stitch.
7. Use this sample for the Blind Hem exercise on the next page.

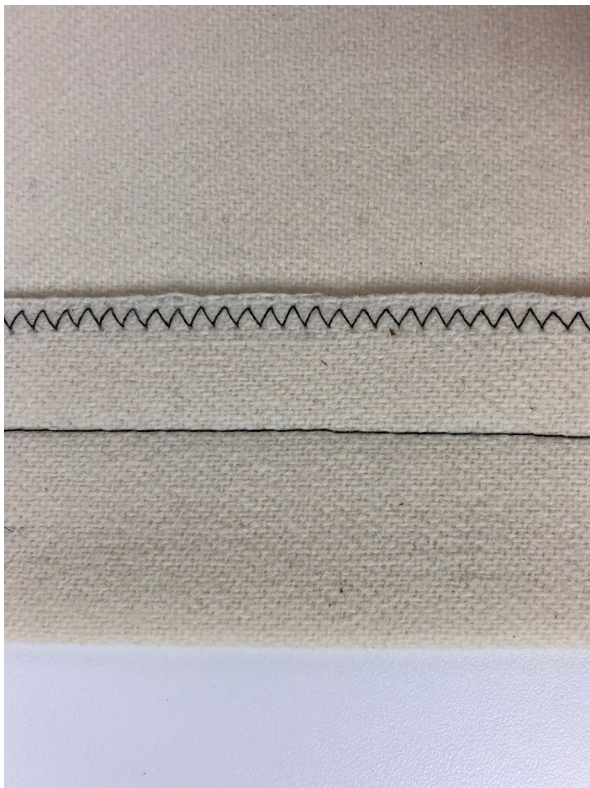





## Sew HOW

Do you know how to:

- Increase the stitch length on your machine?
- Overcast the edge of fabric?

# BLIND HEM

-  Wool-like fabric or heavy flannel, 6" x 7"
-  80/12 Universal
-  Polyester or cotton sewing thread
-  As programmed
-  Blindstitch Sole #5

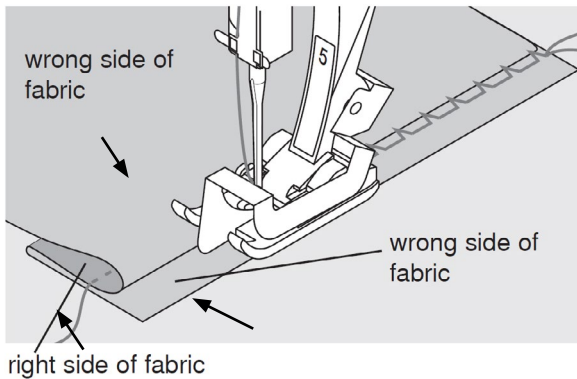
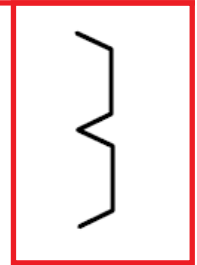

1. Begin with a basted 2" hem as instructed on previous page.
2. Select the Blind Stitch #7 on B 335, 325 / #5 on B 215.
3. Attach Blindstitch Sole #5 to the shank.
4. Fold the hem back to the right side over the basting line, exposing the zigzagged edge of the fabric.
5. Sew on the extended hem allowance, keeping the folded edge next to the guide on the foot.
6. Adjust the stitch width if needed so that the needle barely stitches into the fold. The metal guide on the sole can be adjusted sideways if needed by turning the screw on the right.
7. Unfold the fabric when finished, and notice that the stitches barely show on the right side of the fabric.







## Sew HOW

Do you know how to:

- Machine baste?
- Distinguish the difference between Blindstitch Sole #5 and Edgestitch Foot #10?

# STRETCH STITCH

-  Spandex, 4" x 6", two pieces
-  80/12 Universal (Ballpoint or Stretch may also be used)
-  Polyester or cotton sewing thread
-  As programmed
-  Reverse Pattern Sole #1

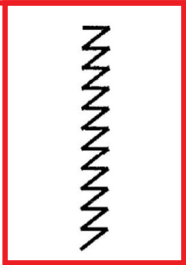







1. Attach Reverse Pattern Sole #1 to the shank.
2. Select the Super Stretch Stitch (#9 on the B 335 and 325, #8 on the B 215).
3. Place the fabric pieces right sides together.
4. Position the edge of the fabric on the 5/8" marking on the stitch plate.
5. Sew the seam.

## Sew **HOW**

Do you know how to:

- What fabric types you would use with this stitch?

# BALANCE

-  Firm woven fabric, 4" x 6"
-  Lightweight tear-away stabilizer 4" x 6"
-  80/12 Universal
-  Polyester or cotton embroidery thread
-  Default
-  Open Embroidery Sole #20

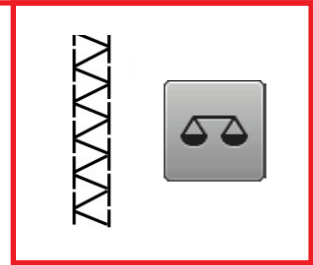

**Notes:**

The Balance function is generally reserved for fine tuning the stitch appearance, but is sometimes required because of differences in fabrics and threads.

The Balance Function is used to troubleshoot and fine tune stitches if they do not produce desired results with default settings. Oftentimes, this is caused by unusual fabrics or threads.

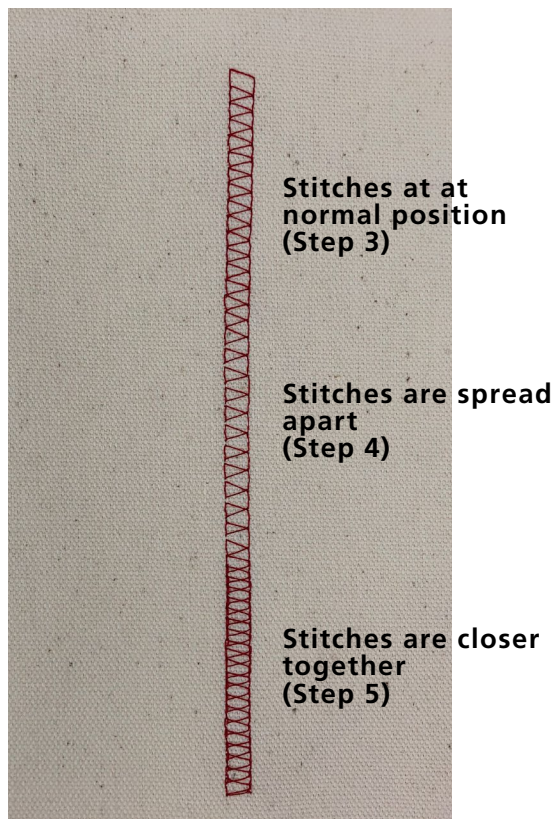

1. Attach Open Embroidery Sole #20.
2. Place the stabilizer behind the fabric.
3. Select the Double Overlock Stitch (#8 on the B 335 and 325, #6 on the 215); sew about 1 1/2" with the Balance Adjuster (on right side of machine) at the normal position.
4. Turn the Balance Adjuster clockwise and stitch for another 1 1/2". Notice that the stitches spread apart. You would use this adjustment if the stitches on your project appear too close together to open them up so they look like the normal stitch.
5. Turn the Balance Adjuster counterclockwise and stitch for 1 1/2". Notice that the stitches appear closer together. You would use this adjustment if the stitches on your project appear too spread apart with the setting at normal.
6. Return the Balance Adjuster to the normal setting.

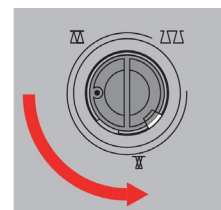
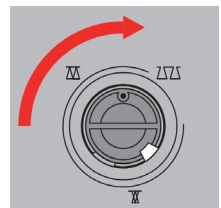
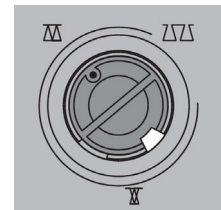







## Sew HOW

Do you know how to:

- Fine-tune the stitch using the Balance Adjuster on your model?



# MANUAL BUTTONHOLES

-  Wool-like fabric or heavy flannel, 6" x 6"
-  Lightweight tear-away stabilizer 3" x 6"
-  80/12 Universal
-  Polyester or cotton embroidery thread
-  As programmed
-  Buttonhole Sole #3  
(optional accessory B 335)

**NOTE:** Use the Manual Buttonhole on the B 335 or 325 when you wish to make a buttonhole longer than 29 mm (the maximum length of an Automatic Buttonhole).

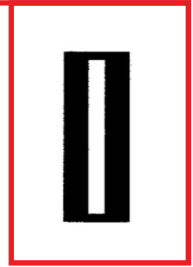
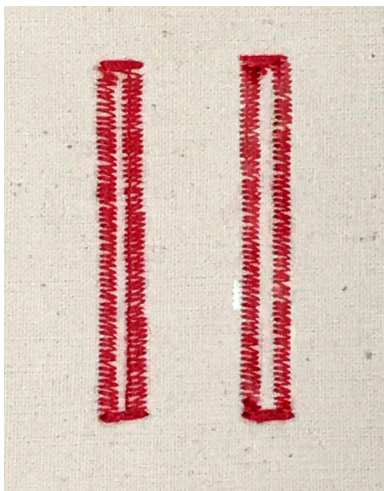

1. Fold fabric in half to 3" x 6" and press.
2. Insert stabilizer between the layers.
3. Mark two dots 1 1/2" apart to simulate the length of buttonhole needed.
4. Attach Buttonhole Sole #3.

## Stitch Standard Buttonhole

1. Select the Standard Buttonhole #0. (Touch clr to clear any previous changes.)
2. Align the first dot directly under the needle.
3. Sew the first step of the buttonhole. Stop at the second dot marked on the fabric.
4. Press the Quick Reverse button and engage the foot pedal or the Start/Stop button to advance to the next step.
5. Sew in reverse (this will be a straight stitch, stopping at the start of the first bead. Press the Reverse button.
6. The machine will sew the bartack at the top and the second bead. Stop at the end of the second bead and press the Quick Reverse button.
7. Engage the foot pedal or the Start/Stop button and the bottom bartack and securing stitches are sewn and the machine stops automatically.
8. Repeat all steps above for any consecutive buttonholes.

## Sew HOW

Do you know how to:

- Measure a button for buttonhole size?
- Adjust buttonhole bead width?

# AUTOMATIC BUTTONHOLE PROGRAM

 Wool-like fabric or heavy flannel, 6" x 6"

 Lightweight tear-away stabilizer 3" x 6"

 80/12 Universal

 Polyester or cotton embroidery thread

 As programmed

 Automatic Buttonhole Foot #3A  
(optional accessory for B 325 / not available for the B 215)

3/4" (19 mm/30L) two-hole button

18" Narrow cord  
(perle cotton, embroidery floss, etc.)

## Tips:

- Because the Automatic Buttonhole is a program, it needs to stitch to completion. Keep the Foot Control depressed until the machine stops stitching, or use the Start/Stop button to stitch the buttonhole.
- Buttonhole Bead Width and Stitch Density are also adjustable.

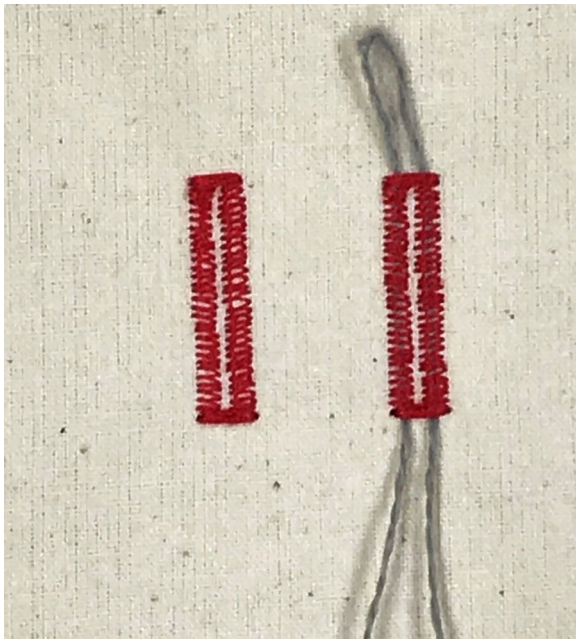

## For B 335 and 325 ONLY

1. Fold the fabric square in half to 3" x 6". Press.
2. Insert the stabilizer between the layers.

## Automatic Buttonhole

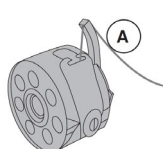
1. Attach Automatic Buttonhole Foot #3A. (This is an optional accessory for the B 325.)
2. Thread the bobbin thread through the finger of the bobbin case. This will increase the bobbin tension and will give the beads on the right side of the fabric a slightly rounded appearance. 
3. Select Standard Buttonhole #0.
4. Mark the beginning placement of one buttonhole.
5. The length of the buttonhole can be set by using the red slider on the foot.
6. Sew the stitch forward and stop when the slider aligns with the red marking on the presser foot. Press the Reverse Button.
  - NOTE: Auto and Automatic Buttonhole Foot with Slide 3A appear on the screen. The buttonhole length is now programmed.
7. The remainder of the buttonhole is sewn automatically. The machine will stop when the buttonhole is complete. The buttonhole is repeatable without re-setting.

## Corded Buttonhole

1. Fold the cord in half and loop the middle around the center "toe" of the foot and put tails in back slits.
2. Stitch a second buttonhole. Carefully remove the fabric from under the foot.
3. Pull the cord ends until the loop is pulled up under the buttonhole stitches; trim the ends of cord.
  - If working on a knit fabric, knot the cord ends together before trimming.
4. Store this buttonhole in Memory. See next page for details.

# MEMORY BUTTONHOLES

Long Term Buttonhole Memory allows you to save buttonholes that you use over and over (shirts, for example). Programmed saved buttonholes can be opened for re-use even after the machine has been turned off. Only one length per buttonhole can be saved. When saving a new length, the previously saved length will be overwritten. Manual buttonholes cannot be saved.

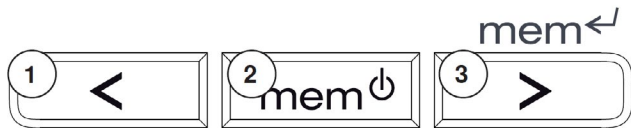
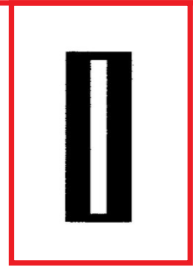

## For B 335 and 325 ONLY

**NOTE:** Buttonhole Foot with Slide #3A must be used to program the buttonhole for saving. This foot is standard with the B 335, and an optional accessory on the B 325. It is not available for the 215.

### To Save a Buttonhole in Memory

1. After the buttonhole you wish to save has been programmed and stitched, select the right arrow next to mem on the front of the machine (3).
2. The buttonhole is now saved.

### To Retrieve a Buttonhole from Memory









1. To retrieve the saved buttonhole, first select the desired buttonhole type.
2. Select the mem button (2).
3. Sew the programmed buttonhole.

## Sew HOW

Do you know how to:

- Program a buttonhole into the memory of your machine?
- Retrieve a programmed buttonhole?

# ATTACHING BUTTONS

-  Firm woven fabric, 4" x 8"
-  Lightweight tear-away stabilizer 4" x 4"
-  80/12 Universal
-  Polyester or cotton embroidery thread
-  As Programmed
-  Button Sew-On Foot #18 (optional accessory)
-  Feed dog down
-  3/4" (19 mm/30L) two-hole button



## B 335 and 325

1. Remove shank from machine and attach Button Sew-On Foot #18 to the machine; lower the feed dog.
2. Select the Button Sew-On Program (#11 B 325, #14 B 335).
3. Fold the fabric in half to 4" x 4" and press.
4. Insert the stabilizer between the layers of fabric.
5. Adjust the pin on the Button Sew-On Foot #18 to the desired position.
  - A short thread shank is appropriate for dress-and blouse-weight fabrics (lower the pin towards the button).
  - A tall shank is appropriate for coat and jacket-weight materials (raise the pin above the button).
6. Check the distance between the holes of the button by turning the hand wheel. Adjust the stitch width if necessary so that the left and right swings of the needle fall into the holes of the button. Hold the thread tails as you begin to sew.
7. When using the Button Sew-on Program, the machine stops automatically when the program is complete (keep the Foot Control fully depressed until the machine stops, or use the Start/Stop button); the thread tails are secured as part of the program.

### Tips:

- Using the lowest shank setting and the instructions above attach a charm(s) or snap or hook and eye.
- Stitch a ribbon with this technique (the stitch makes a bartack) and then tie the ribbon into a bow.



## B 215

1. Remove shank from machine and attach Button Sew-On Foot #18 to the machine; lower the feed dog.
2. Select Zigzag Stitch #2.
3. Change the width of the stitch to fit the width of the holes in the button.
4. Sew 6 to 8 zigzags and stop.
5. Bring the thread tails to the wrong side of the fabric and knot them together; trim the excess thread.

## Sew HOW

Do you know how to:

- Lower the feed dog?
- Adjust the shank on Button Sew-On Foot #18?



# STITCHING ZIPPERS

 Firm woven fabric, two 4" x 8" pieces

Neckline zipper, 4 to 7" length

 80/12 Universal

 Polyester or cotton embroidery thread

 As instructed

 Reverse Pattern Sole #1

 Zipper Sole #4

Optional: Zipper Foot with Guide #54

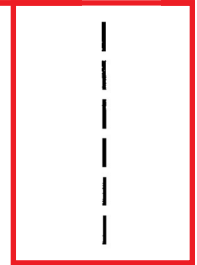

## Attaching the Zipper to Garment

1. Attach the Reverse Pattern Sole #1.
2. Place long edges of fabric with right sides together. Using a straight stitch, sew with a 3/4" seam allowance from one short end up to where the zipper stop will be (about 2"). Baste the rest of the seam with a stitch length of 5.0 mm, sewing 2 to 3 stitches in reverse at the end to secure the seam; return to a straight stitch length of 2.5 mm.
3. Press the seam allowances open. Place the right side of the zipper against the seam allowances with the zipper teeth centered over the seam. Pin or baste each side of zipper to the seam allowances only.
4. Change to the Zipper Sole #4; adjust the needle position to the right or left as needed to stitch close to the zipper teeth. Sew through the zipper tape and the seam allowance only, from bottom to top on each side of the zipper.
5. Pin or baste through all layers to hold the sewn zipper to the project.

## Topstitching the Zipper

1. Change to Zipper Foot with Guide #54 (optional foot).
2. Left Side: Adjust the seam guide to one notch to the right of center. Adjust the needle position to the far left. Sewing from the right side of the fabric and starting at the lower edge, sink the needle into the seam. Sew out about 3/8", stop, pivot and make sure the seam guide is lying in the ditch of the seam. Sew up the left side of the zipper, stitching through all layers.
3. Right Side: Adjust the guide one notch to left of center; move the needle position to the far right. Repeat the above steps on the right side of the zipper.



# COMBINING STITCH PATTERNS

Decorative stitches, letters, and numbers can be combined and stored in Memory on the B 335 and B 325. These machines have a capacity of 30 spaces. Stitch the combination using an appropriate foot for the stitches in the combination.

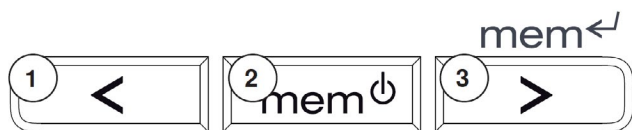

NOTE: The B 335 and 325 have a capacity of 30 spaces.

## For B 335 and 325 ONLY

### Combining Stitch Patterns

1. Select the mem button (2).
2. Select a decorative stitch.
3. Touch the right arrow on machine (3).
4. Select a second decorative stitch. Touch the right arrow (3).
5. Select a third decorative stitch. Touch the right arrow (3).
6. Press the foot control and the machine automatically start at the beginning of the stitch combination.
7. To stop at the end of a stitch combination, press the Pattern End button.

Note: The contents of the memory will be lost if the sewing machine is switched off without saving it.

### Saving in Memory

1. After stitching the combination, touch the mem (2) button to close.

### Overwriting Stitch Patterns, letters and/or numbers

1. Scroll with the right arrow (3) or left arrow button (1) to find the stitch pattern you want to overwrite.
2. Select the new stitch number/letter/number and make changes as desired (length/width or needle position).
3. Press the right arrow button (3); the stitch pattern has been overwritten.







### Deleting Stitch Patterns, letters and/or numbers

1. Scroll with the right arrow (3) or left arrow button (1) to find the stitch pattern you want to delete.
2. Press the clr button.
3. The stitch pattern has been deleted.

### Retrieving Stored Memory

1. Press the mem (2) button.
2. Stitch the pattern.

# PROGRAMMING ALPHABETS AND NUMBERS

-  Firm woven fabric, 4" x 6"
-  Lightweight tear-away stabilizer 4" x 6"
-  80/12 Universal
-  Polyester or cotton embroidery thread
-  Default
-  Open Embroidery Sole #20



## For B 335 and 325 ONLY

1. Attach Open Embroidery Sole #20.
2. Place the stabilizer behind the fabric.
3. Press the button (2) on the machine. The cursor and the available number of empty memory spaces (e.g.30) start to blink, and mem appears on the screen.
4. Press the Alphabet button (5) to select the alphabet of your choice.
5. The letter A in the alphabet of your choice appears on the display
6. Use the Arrow Buttons (4 and 6) to scroll the alphabet
  - Select desired letter or number. For this lesson select the B.
  - Press the button (3); the letter is programmed.
  - Scroll with the Arrow buttons to the letter E.
  - Press the button (3); the letter is programmed.
  - Continue in the same manner to add R, N, I, M, A. (The M is purposely misspelled).

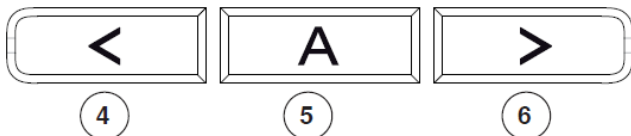
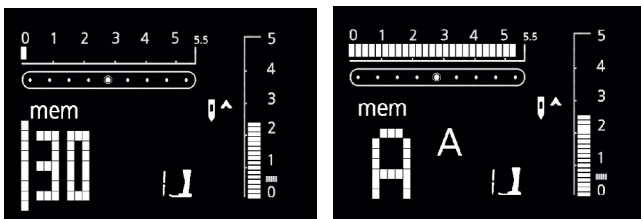
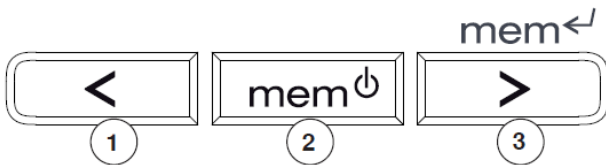

To delete the complete Memory contents:

- Press the clr button, keep depressed and press the button (2). Release both buttons.
- Leave Memory by pressing the button (2).
- Memory is now completely deleted and new lettering can be added.

NOTE: When programming more than one word, select the underscore symbol ( \_ ) to program a space between the words.

7. To correct the letter M to an N:
  - Scroll with the left arrow (4) to the letter M.
  - Scroll with the right arrow (6) to the letter N.
  - Press the right arrow (3); the letter is overwritten.
8. Stitch out the word BERNINA. Activate Pattern End after the stitching has started so that the machine will stop at the end of the word.
9. To save the word into Memory, you MUST press the (2) button. The contents are saved and Memory is closed. This must be done before the machine is turned off. The contents of Memory remain saved even when the machine is switched off and can be recalled at any time.

# FREE-MOTION STITCHING

 **Two 12" x 12" pieces medium weight cotton**  
**One 12" x 12" piece low-loft cotton batting**

 **80/12 Quilting needle**

 **50 weight thread in needle and bobbin**

 **Default**

**Darning Foot #9 or**

 **Freehand Embroidery Foot #24 or**  
**Freehand Quilting Foot #29 or**  
**Tear-Drop Embroidery Foot #26**  
**(optional accessories)**

 **Feed dog down**

## Free Motion Tips:

- BERNINA presser feet designed for free-motion stitching have a patented hooper mechanism that holds the fabric as the needle pulls away, making it easy to move the fabric.
- The key to successful free-motion stitching is to run the motor at a consistent speed and move the fabric at a consistent and smooth speed.
- Set the Slide Speed Control to medium and floor the foot control, or use the Start/Stop button on the machine.



*Free-motion stitching refers to sewing without the feeding aid of the sewing machine. The feed dog is lowered and the fabric stays in the same place unless you manually move it. Free-motion stitching is used in quilting, bobbinplay, and thread painting.*

1. Make a "quilt sandwich" with the batting between two layers of fabric and practice "drawing" a variety of shapes (see below) on fabric as follows:
2. Lower the feed dog.
3. Using the foot control or the Stop/Start button to run the machine, move the fabric in a forward and back motion.
4. Move fabric from top to bottom; then side to side, keeping the lines of stitching perpendicular to each other (1).
5. Stitch as you move fabric and stitch to the right, down, to the right, up, to the right, down, to the right, and up (2).
6. Move the fabric in smooth curves in an up and down motion working from left to right (3).
7. Move the fabric in loops (4) or figure 8 shapes.
8. Create stippling shapes – think of interconnecting puzzle pieces with evenly sized "bumps." Avoid "painting yourself into a corner" and/or stitching across a previously stitched line (5).

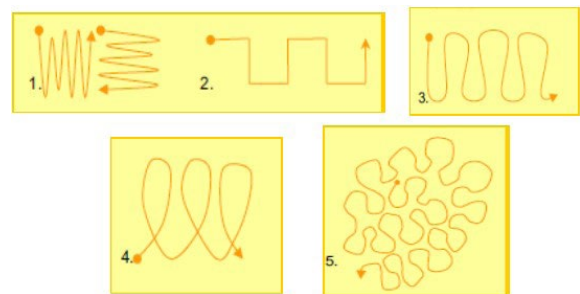

## Sew HOW

Do you know how to:

- Lower the feed dog?
- Move the fabric for even and consistent stitching?



# REFERENCE - BERNINA PRESSER FEET

---



## Easy-on/Easy-Off Soles

The BERNINA 335, 325, and 215 have simple-to-use, easy-on/easy-off metal soles that attach to a standard shank. These BERNINA models are also compatible with the full-shank presser feet available as optional accessories.

The BERNINA 335, 325, and 215 can use most BERNINA full-shank, non-lettered feet. Your BERNINA dealer can help you select additional presser feet to suit your sewing needs. A guide to the capabilities and machine setup for techniques can be found in the BERNINA Big Book of Feet.

## BERNINA PRESSER FEET



- are engineered for specific functions
- are Swiss-engineered for the highest quality
- are one-piece metal feet, making them sturdy and durable
- are easy to change with one hand, requiring no special tools
- have a white shank, making it easier to see the eye of the needle, resulting in easier threading
- are, in some cases, modeled after commercial feet used in factories to increase speed and production with professional results
- do the job intended in relation to all types of sewing (example: quilting, garment-making, home dec, etc.)
- are supported by the best and most complete educational materials in the industry, including reference books detailing each foot and its uses

# REFERENCE - SEWING MACHINE NEEDLES

## Needle "Secret" Code

- DRI = Triple
- E = Embroidery
- J = Jeans
- L, LL, R = Leather
- M = Microtex
- MET = Metallic
- N = Topstitching/  
Cordonnet
- Q = Quilting
- S = Stretch
- SUK = Fine Ball Point
- SES = Medium Ball Point
- WING = Wing
- ZWI = Double
- ZWI = Double
- ZWIHO = Double Wing

## Needle Size Conversion

Regardless of the system, the greater the number, the larger the diameter of the needle.

### European vs. Domestic

60=8	90=14
70=10	100=16
75=11	110=18
80=12	120=19

## Needle Size for Fabrics

- 60 – very fine batiste
- 70 – shirt-weight
- 80 – medium-weight
- 90 – denim and twill
- 100/110/120 – canvas

## General Information

Along with thread, needles are very important to stitch formation. Many "mechanical" problems and damage to fabrics can be traced to a bent, damaged, or incorrect size or type needle.

When selecting the correct needle, consider the following:

- Needle system – 130/705H
- Needle point – assures proper stitch formation; avoids fabric damage
- Needle size – smaller for lightweight fabrics; larger for heavier fabrics

If the needle is:

- Too small – the thread can't stay in the groove to form a loop to be picked up by the hook point
- Bent – the thread loop forms too far away from hook point and the hook can't enter the loop to form a stitch
- Blunt – the needle won't pierce fabric, so no thread loop forms to make a stitch

## Need to Know

- Needles should be changed after every 8 hours of stitching, or earlier if stitches are looking bad. The needle is the most inexpensive part in your sewing machine, but it is crucial for getting good results and keeping your machine running well. Don't let false economy keep you from doing what is best for your sewing projects and your machine.
- The selected thread should fit in the groove on the front of the needle. If it isn't protected by the groove, a needle with a larger groove should be used.
- Always make sure needles are fully inserted as high as possible, with the flat side to the back.

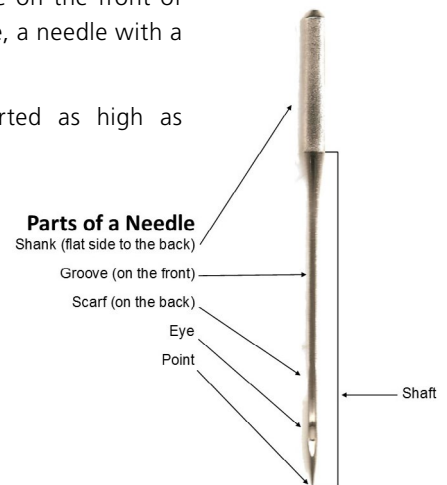

# REFERENCE - SEWING MACHINE NEEDLE CHART

TYPE	SIZES	DESCRIPTION
Ballpoint	60 – 100	Has a rounded point. Size 70 for lingerie, nylon, jersey; 80 for t-shirt; 90 for sweatshirt fleece.
Stretch	70 – 90	A Stretch needle has a more rounded point than a Ballpoint, and a blue anti-cling coating which helps to prevent skipped stitches in knits and elastic. Sometimes used on Ultrasuede, vinyl, and plastic.
Universal	60 – 120	A compromise between a Sharp and a Ballpoint; used on both wovens and knits.
Double	1.6/70 – 8.0/100	Two needles attached to one shank. For pintucks, hems, and decorative work. Available in Universal, Stretch, Jeans, Metallic, and Embroidery needles.
Triple	2.5/90 – 3.0/90	Three needles attached to one shank. Used to create mock smocking and other decorative effects.
Jeans	70 – 110	Has a sharp point and a shaft that is less prone to flex. The sharpness of the needle is better for use on denim and woven fabrics.
Leather	80 – 100	Point is a sharp cutting wedge. Used for leather only. Not for vinyl or simulated leathers.
Microtex / Sharp	60 – 90	Sharp point; thin shaft. Specially designed for microfiber fabrics.
Quilting	75 and 90	Thin, tapered point eliminates potential damage to fabric when seaming and cross-seaming.
Topstitch	70 – 100	A sharp point with a large eye and deep groove. For use with heavier fabrics – the large groove cradles heavier threads.
Embroidery	75 and 90	Light ballpoint needle with large eye and groove; has a coating and a larger scarf. Prevents shredding of rayon or metallic threads. Two threads may be used through the eye.
Metafil	80	Similar to Embroidery needle with large eye and deep groove. Made of a heat-resistant alloy with a friction-reducing coating. Suitable for manufactured fibers such as polyester, acrylic, and nylon.
Wing	100 and 110	Sharp-pointed needle with a non-cutting metal wedge on each side. Makes a hole without cutting the threads of the fabric. Used for decorative and heirloom work, such as hemstitching.
Double Wing	100	One Universal needle and one Wing needle attached to a single shank.
Metallic	70 – 100	Designed for metallic threads; has a large eye and deep groove.

# REFERENCE - THREADS

To achieve quality stitches, a sewing machine needs three things: suitable thread, correct size needle, and properly adjusted thread tensions. Poor quality or the wrong type of thread can cause inferior stitches on any machine. Inferior thread results in crooked and looped stitches, puckered seams, frayed thread, and/or needle breakage. Did you know that thread passes through the eye of the needle approximately 37 times in a “seesaw” action before it forms a single stitch?

Long staple threads are stronger and smoother than short staple threads. (Staple refers to the length of fibers twisted together to form a single ply). Most bargain-priced threads are usually short staple and will deposit more lint and fuzz into your sewing machine, potentially causing tension inconsistencies and possibly even damage to your machine over the long term. Using long staple threads also result in less snagging and fraying as you sew.

Ply refers to the number of strands twisted together to make a single thread. The number of plies is usually indicated by a number after the weight of the thread such as 50/3, which means a 3-ply, 50-wt. thread. The lower the weight, the heavier the thread; conversely, higher numbers indicate fine or lightweight thread.

## Guidelines for Thread Weights

- 12 wt.— Couching, bobbinwork
- 30 wt.— Embroidery, bobbinwork
- 40 wt.— General construction, quilting, embroidery
- 50 wt.— General construction, piecing, bobbin thread, quilting
- 60 wt.— Lingerie, heirloom, appliqué, bobbin thread, quilting
- 80 wt.— Extra-fine lingerie, heirloom

## Fibers

Fiber refers to the type of material used to produce the thread.

## Polyester

Good for clothing construction on man-made, natural or blended fabrics. Tolerates high temperatures. Polyester embroidery thread has a high sheen; excellent for embroidery, very abrasion resistant, and will not fade.

## Cotton

Available in a wide range of weights from 12-100, cotton thread gives a soft, full look to embroidery, appliqué, and buttonholes. It is also excellent for clothing construction on natural fibers, patchwork piecing, darning, and heirloom sewing.

## Rayon

A glossy embroidery thread, rayon is not as strong as cotton and polyester fibers, making it useful for decorative work, but not for construction techniques.

## Silk

Used on silk and wool fabrics, this strong, lustrous fiber is good for construction and decorative details such as buttonholes. Also used for quilting as it blends into the fabric.





# REFERENCE - DECORATIVE STITCHING

As you begin to experiment with decorative stitches on your BERNINA machine, there are several things you should keep in mind:

- Type of thread you plan to use
- Presser foot you select
- How you prepare your fabric

## Type of Thread

Selecting the thread for decorative stitching often comes down to a personal preference and what looks best on your project.

Cotton embroidery thread, especially in a heavier weight such as 30, gives a beautiful look to the stitches, has a nice luster to it and fills in well.

If you want a high sheen, rayon or polyester embroidery thread are good choices.

## Preparing the fabric

Preparing your fabric correctly can take the frustration out of your stitching, giving you a positive experience with beautiful results. The fabric needs to be stable enough to support the stitching without tunneling or puckering. This can be accomplished in several ways, sometimes with a combination of techniques:

- The fabric itself might be heavy enough to support the stitching.
- Interfacing (fusible or sew-in) can be applied to the wrong side of the fabric and left in the project.
- Stabilizers are used as a temporary form of support.

*For the exercises in this class, you will be using light-weight tear away stabilizer that can be removed after stitching if desired.*

## Presser Foot

The presser foot/sole you select is critical for good results because it can affect the way the fabric feeds under the needle, influencing the stitch formation.

Usually the key to selecting the correct presser foot is the bottom of the foot/bottom of the sole.

Stitches that are more open and have less thread will stitch well with an all-purpose or zigzag presser foot.

- Reverse Pattern Sole #1 (Reverse Pattern Foot #1) has small indentations in front of and behind the needle that allow the fabric to move in a "back and forth" manner when forming the stitches.

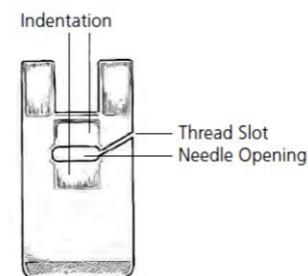

If you are creating heavy, satin stitched patterns, you will need a foot that is not flat on the bottom. It should have some type of indentation that allows the foot to ride over the completed stitch without dragging or inhibiting the feed of the fabric.

- Embroidery Foot #6 has a wedge-shaped indentation behind the needle, perfect for allowing heavy compact stitches to flow freely from under the back of the presser foot.

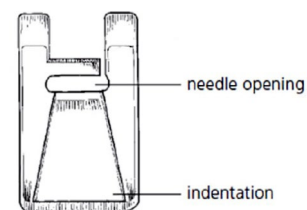

- Open Embroidery Sole #20 (or optional Foot #20) and optional Clear Embroidery Foot #39 both have the same shape but the Clear Embroidery Foot offers more visibility of the stitching area.

# REFERENCE - CLEANING AND OILING

One of the most important parts of maintaining your machine is proper cleaning and oiling. Below are tips to follow, but more complete instructions for your specific model can be found in your machine's manual.

It is recommended that you clean and oil every other bobbin, or every 8 hours of actual sewing time. If you notice your machine sounding louder than usual, then it is time to clean and oil.

## Cleaning the screen and the machine

- Wipe with a damp cloth.

## Cleaning the feed dog area

Clean the machine after every use; remove any lint from under the stitch plate and in the hook area.

- Turn the power switch to «0» (off) and unplug the machine.
- Remove the presser foot and needle.
- Press the stitch plate down at the back right corner, lift and remove.
- Clean the area with the lint brush.
- Replace the stitch plate.



## Cleaning the hook

- Turn the off power switch and unplug the machine.
- Remove the bobbin case.
- Push down the locking lever and the black hook race cover.
- Remove the hook.
- Clean the hook race with a cloth or brush; never use a sharp instrument.
- Replace the hook, turning the handwheel if necessary until the hook driver is on the left.
- Close the hook race cover and secure with the locking lever. The locking pin must engage.
- Check by turning the handwheel.
- Insert the bobbin case.



## Oiling the machine

- Turn off the power switch and unplug the machine.
- Squeeze 1 or 2 drops of oil into the hook race as shown in the picture to the right.
- Run the machine for a short time without thread to prevent oil from soiling your work.

