

DABA

GATIS



Necessary tools for instruction



- Level tool

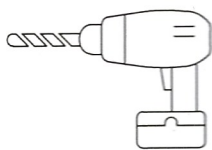

- Screw drill machine

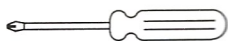

- Screw driver



- Drill bit Ø4mm

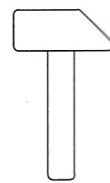

- Hammer

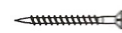

- Screws (come with the kit)

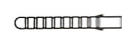

- Dowel (come with the kit)

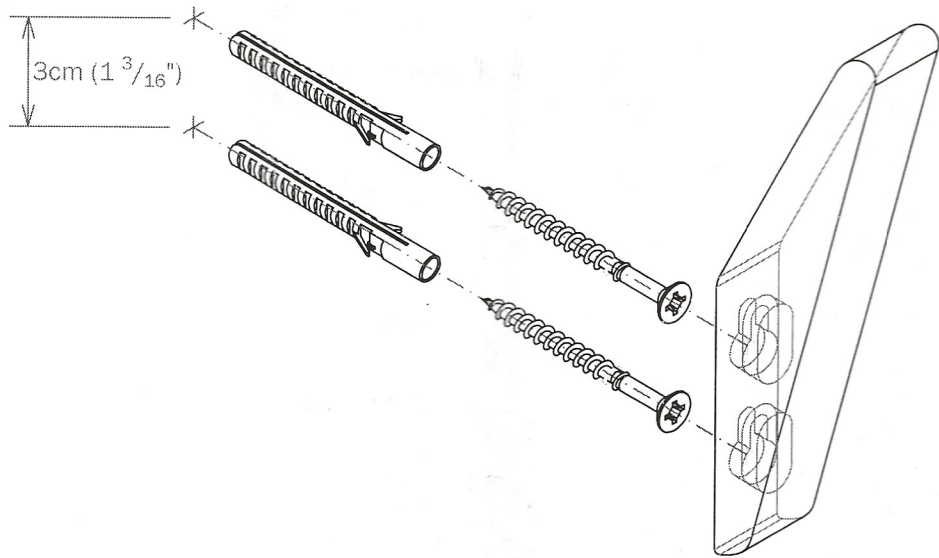

1.

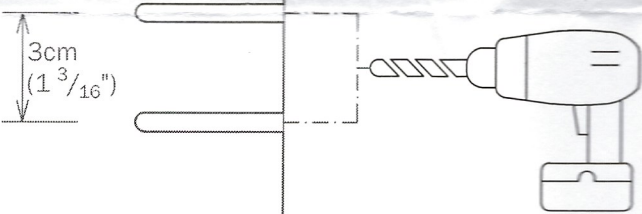

2.

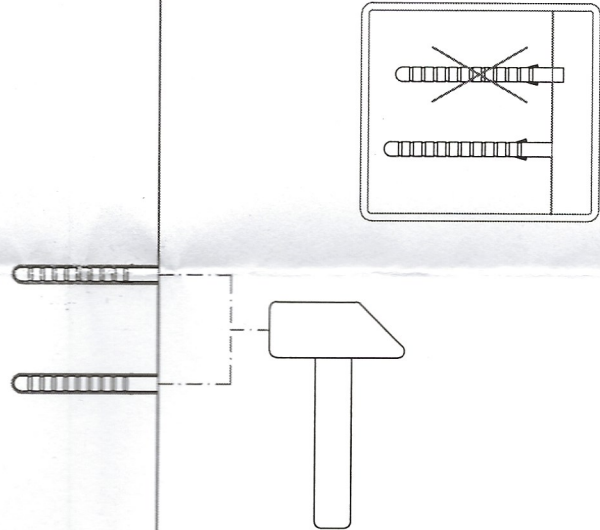

3.

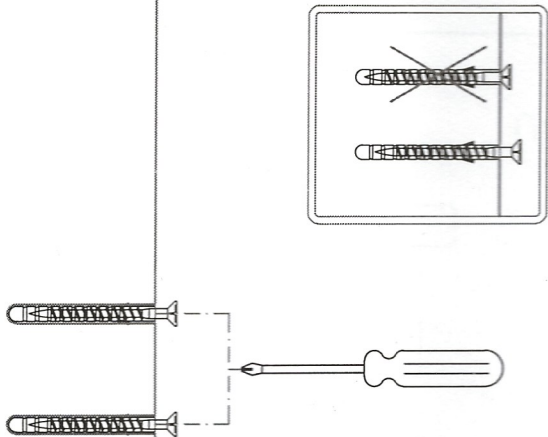

4.

