

# 10.1" Overhead In-Vehicle Entertainment System

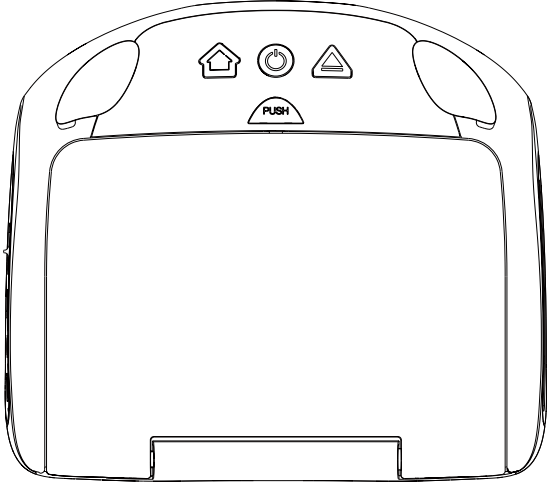

**OWNER'S  
MANUAL**



## **Congratulations**

Congratulations on your purchase of this In-Vehicle Entertainment System! The system has been designed to provide passengers with unlimited content options delivering smiles for many miles. Please read the directions that follow to familiarize yourself with the product to ensure that you obtain the best results from your equipment.

## **Safety Precaution**

The system has been designed so that it can be directly controlled through the monitors touch screen interface or remotely controlled directly by the user(s) using the VoxxLink APP. If the users are too young to control the system monitor themselves, adults in the vehicle can remotely control the system monitor using the VoxxLink APP. It is recommended that physical source media such as DVDs, USB thumb drives, and SD cards are not changed while the vehicle is in motion. Enjoy your entertainment system but remember that the safety of all passengers remains the number one priority.

## **Important Notice**

Installation of overhead products requires careful planning and preparation. Be extremely careful when working on a vehicle with side curtain air bags. Do not route wires near any portion of the side curtain air bag assemblies. This includes any anchor points in A, B, C or D pillars of the vehicle. Routing wires in these areas or running wires by the side curtain air bags can prevent the side curtain air bag from fully deploying which can result in personal injury to vehicle occupants. If you have any questions regarding wire routing in a vehicle, please contact Voxx Technical Support at 1-800-645-4994.

When connecting power and ground in a mobile video installation ensure that the ACC wire is fused at the point where it is connected to the vehicle ACC wiring. Failure to do so can result in damage to the vehicle if a short circuit develops between the vehicle connection point and the mobile video product.

An LCD panel and/or video monitor may be installed in a motor vehicle and visible to the driver if the LCD panel or video monitor is used for vehicle information, system control, rear or side observation or navigation. If the LCD panel or video monitor is used for television reception, video or DVD play, the LCD panel or video monitor must be installed so that these features will only function when the vehicle is in "park" or when the vehicle's parking brake is applied.

An LCD panel or video monitor used for television reception, video or DVD play that operates when the vehicle is in gear or when the parking brake is not applied must be installed to the rear of the driver's seat where it will not be visible, directly or indirectly, to the operator of the motor vehicle.

## **Warnings**

- Do not use any solvents or cleaning materials when cleaning the video monitor.
- Do not use any abrasive cleaners, they may scratch the screen.
- Use only a lightly dampened lint free cloth to wipe the screen if it is dirty.
- Before putting on headphones always adjust the volume setting to the lowest position.
- Remember to leave the dome light switch in the off or auto position when the vehicle is unattended, as the dome lights, if left on, can drain the vehicle battery.
- Do not put pressure on the screen.

## TABLE OF CONTENTS

Features .....	5
Accessories .....	6
Controls and Indicators Diagram (Front View) .....	7
Getting Started .....	9
Home Main Menu .....	10
System Applications .....	12
USB & SD Card Playback. ....	13
WIFI Connection .....	14
VOXX LINK.....	16
WFMM(Wireless FM Modulator).....	18
IR Headphone Transmitter.....	19
User Interface Language.....	20
About Device & Check for Update .....	21
Time Zone & Reset .....	23
Brightness Control .....	24
DVD Playback.....	25
Media & File Type Compatibility .....	26
Troubleshooting .....	27
General Specifications .....	29
Compliance Information.....	30

## FEATURES

- Android Operating System
- Quad-core Processor
- RAM (8GB)
- Internal Memory (16GB)
- 10.1" TFT LCD Display (1024x600)
- Capacitive Multi-Touch Panel
- User Downloadable Apps  
(Play Store, Chrome, Netflix and Disney Plus apps preloaded\*)
- MicroSD Card (Supports up to 64GB)
- USB 2.0 Input (Supports up to 64GB)
- Integrated DVD Player
- 100 Channel Wireless FM Modulator
- Dual Channel IR Headphone Transmitter
- Wi-Fi 802.11 a/b/n/g Dual Band (Hotspot Required)
- VOXX LINK Remote Control (APP for Android and iOS)

\* All trademarks and their respective logos cited herein are the property of their respective owners.

## ACCESSORIES

### Wireless Headphones

The monitor includes a built-in dual channel infrared transmitter for use with the included wireless headphones. The wireless headphones must be used within a direct line of sight from the screen. Infrared transmission, like visible light, travels only in a straight line.

### How to Use the Wireless Headphones

When wearing the headphones, make sure to observe the “Left” and “Right” labels. The headphones must be oriented correctly in order to receive the audio signal. Press the power button located on the side of the headphone. Volume can be adjusted by rotating the wheel on the outside edge of the headphone. The headphones are designed to automatically turn off after approximately 3 minutes of no activity to help prevent battery drain. If the headphones are not going to be used for an extended amount of time it is recommended to remove the batteries to prevent damage of the headphones due to battery corrosion.



## CONTROLS AND INDICATORS DIAGRAM (FRONT VIEW)

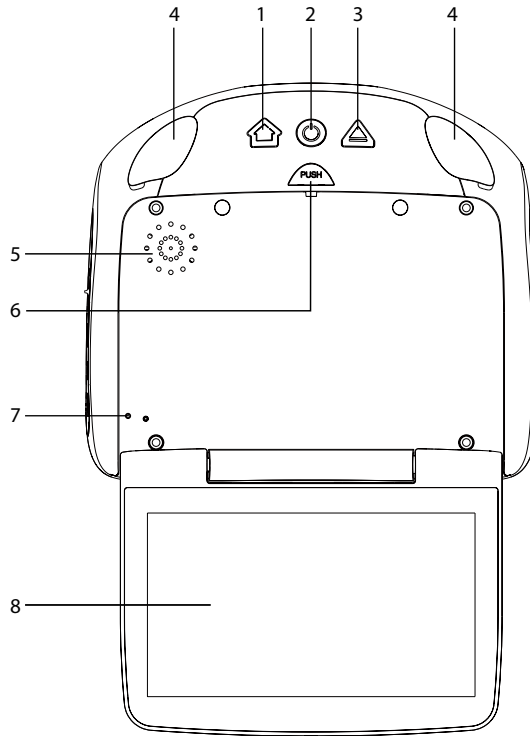

- 1. HOME (🏠) Button**  
This button is used to display the Home Menu Screen.
- 2. POWER (🔌) Button**  
This button is used to turn the system on/off.
- 3. EJECT (⚠️) Button**  
This button is used for ejecting a disc from the built-in DVD player.
- 4. Dome Lights**  
Provide additional interior illumination.
- 5. Ventilation Openings**
- 6. Screen Release**  
Push this button to release the screen from the locked position.
- 7. LCD Backlight Cut Off Switch**  
Used to turn off the LCD backlight when the LCD is in the closed position.
- 8. LCD Panel**

## CONTROLS AND INDICATORS DIAGRAM (SIDE VIEWS)

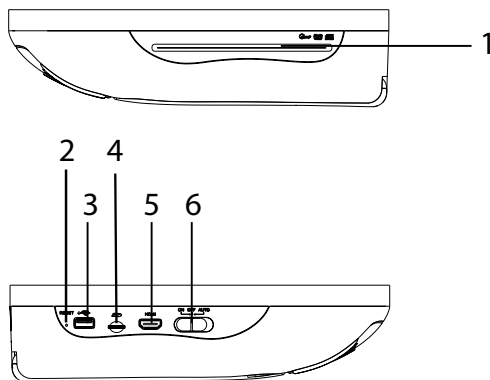

### 1. DVD Disc Insertion Slot

For loading and removing discs. When a disc is inserted, the unit will automatically turn ON and switch to DVD source. Insert a disc with label side facing up.

**Note:** The disc slot indicator is red when a disc is inserted and green when the disc slot is empty.

### 2. RESET

This button provides a system-level power reset. On left side nearby USB port, It does not affect the user settings.

### 3. USB INPUT

This input supports media playback from a USB thumb drive (up to 64GB). This port will also support USB charging (1amp) to provide power to a device that requires external USB power.

### 4. SD CARD

This input supports media playback from micro SD cards (up to 64GB).

### 5. HDMI INPUT

For connection of devices with HDMI outputs.

**Note:** Requires an HDMI device and may require a special HDMI adapter. Contact your HDMI device supplier for the adapter.

### 6. THREE POSITION DOME LIGHT SWITCH

**ON** - Turns on the dome lights.

**OFF** - The dome lights will not turn on in this position.

**AUTO** - Automatically turns on the dome lights in conjunction with the vehicle's interior illumination.



## GETTING STARTED

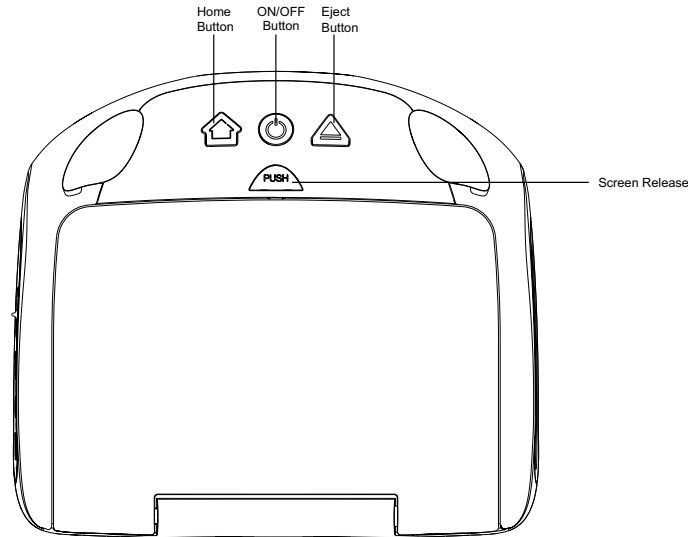

1. To start the system, the vehicle ignition key switch must be in ACC or engine ON position.
2. The Power Button and Home Button will flash RED and BLUE while the system is booting up. Once the boot up process is completed, the Power Button and Home Button will turn RED, and stay in Standby position. It will take approximately 12 seconds to 15 seconds to complete the system boot up process.
3. Once the Power and Home buttons are solid RED, press the Power Button to turn the system ON and the logo image will appear on the screen. After the logo image displays, the Home Main Menu will appear on the screen.

## HOME MAIN MENU

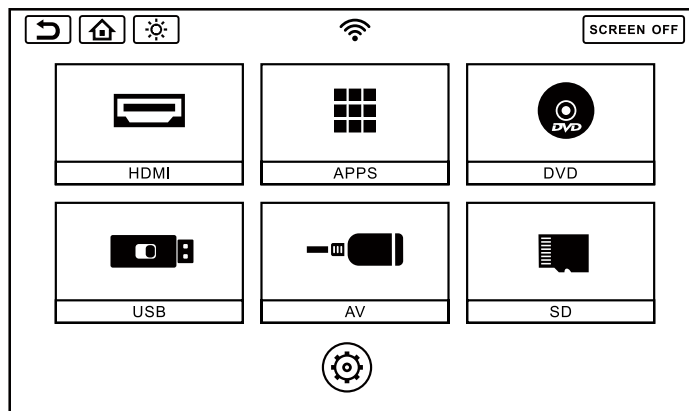

### HDMI

The HDMI inputs allow the user to enjoy high-definition digital images and high-quality sound by connecting an HD device such as a Blu-ray player or smartphone with an HDMI output to the system. Plug in the HDMI device with a special adapter available from your mobile phone provider.

#### Notes:

- This source requires an HDMI enabled device and a special HDMI adapter. Contact your HDMI device supplier for the adapter.
- Phone functionality (phone calls, texting, etc.) may be limited while using the adapter.
- HDMI content is copy protected and is not available on the AV output of the AMOVA10/OVA10 System.

#### APPLICABLE HDMI FEATURE

- Input audio signal: 2 channel.
- Input video signal: 480p, 576p, 720p, 1080i, and 1080p.

## HOME MAIN MENU( CONTINUED)

### **APPS**

This system comes pre-loaded with the following apps: Google Play Store, Chrome Browser, Netflix. and Disney Plus. You may also log into the Play Store with your Google account and download your favorite apps directly. If you do not have Google account, creating one is easy and free.

### **DVD**

The DVD source input is used to play DVDs, Audio CDs and MP3 discs.

### **USB**

The USB source input is used to play MP3 files, JPEG files (Photos) and MPEG **I, II** files. See page 30 for more information.

### **AV**

An external video source, video game system, or other audio/video devices can be connected to the AV input. This AV input connection is normally performed when the unit is installed. Turn the video source component on with its power button or remote control and it is now ready to play the audio and video signals from the source connected to the AV input.

### **Micro SD Card Slot**

Supported SD Card Device up to 64GB.

### **SETUP**

Allow user to access the system menu.

## SYSTEM APPLICATIONS

This system comes pre-loaded with the following apps: Google Play Store, Chrome Browser, Netflix and Disney Plus. You may also log into the Play Store with your Google account and download your favorite apps directly. If you do not have Google account, creating one is easy and free.

1. Connect the AMOVA10/OVA10 monitor to a Wi-Fi hotspot Refer to page 14 for details.
2. Select "APPS" from the main menu screen.
3. Select the Play Store to download your choice of applications (connection to a Wi-Fi hotspot is required).
4. Touch the log-in button and use the on-screen keyboard to enter your Google account credentials to allow access to the Play Store.
5. Download and install the apps you wish to use on the system.
6. From the "APPS" main screen, you may choose the application you wish to use on the system. Press the "HOME" button to exit any applications and return to the "HOME" screen.

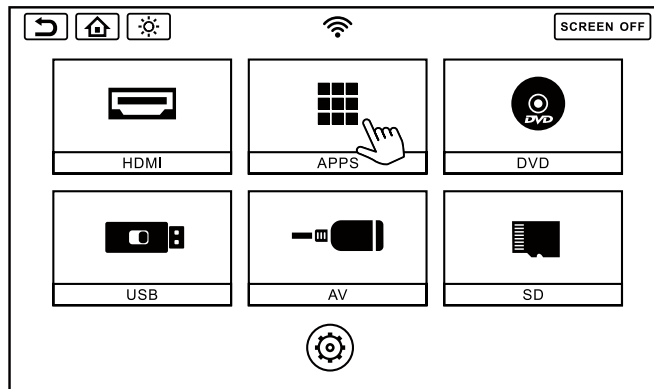

### NOTES:

A total of (12) applications can be installed on the monitor. Google Play Store, Chrome Browser, Netflix and Disney Plus are pre-loaded from the factory and cannot be deleted.

Users can download (8) apps in addition to the (4) that are pre-loaded on the monitor.

Once (8) apps have been downloaded to the monitor, an app must be deleted before a new app can be downloaded.

## USB & SD CARD PLAYBACK

### USB PLAYBACK

1. Insert a USB device into monitor USB port.

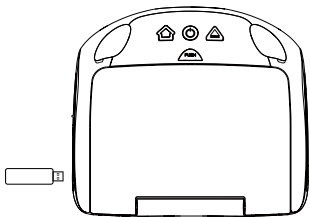

2. Select USB source in the Main Menu.

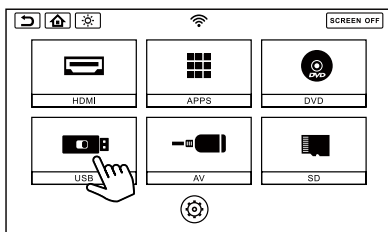

3. Select the playing mode Video, Music or Photo.

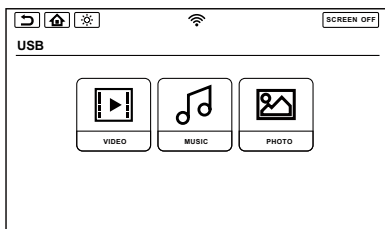

### SD CARD PLAYBACK

1. Insert a Micro SD Card into the monitor.

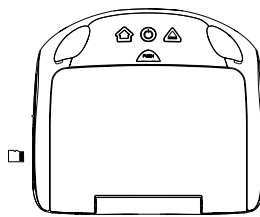

2. Select SD source in the Main Menu.

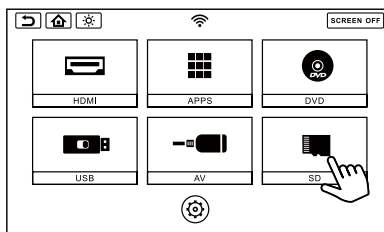

3. Select the playing mode Video, Music or Photo.

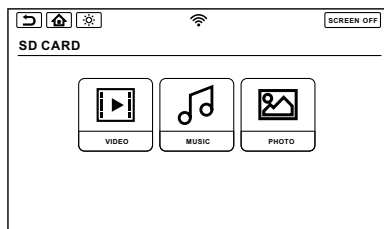

# WIFI CONNECTION

1. Select SETUP in the Main Menu.

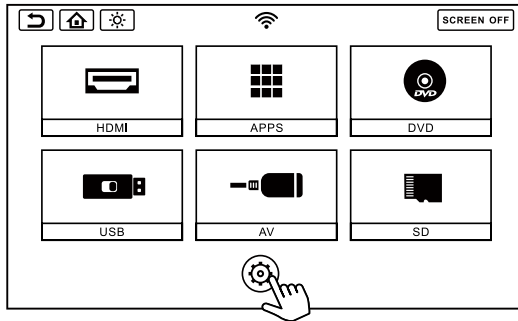

2. Select WIFI and turn ON the WLAN and then touch the WLAN Bar.

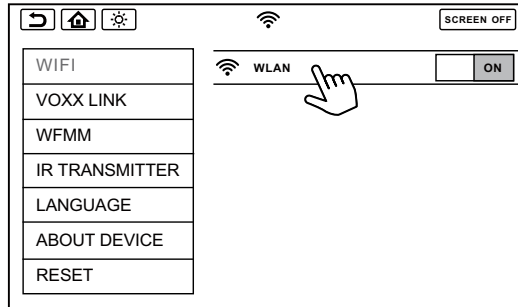

3. Select a Wi-Fi network from the available list.

## WIFI CONNECTION(CONTINUED)

4. Touch the line to enter the password, and the on-screen keyboard will appear.

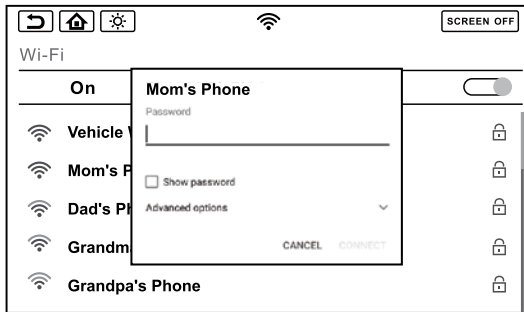

5. Enter the Wi-Fi password using the on screen keyboard. Then press "DONE" to enter the password.



6. The monitor will now connect to the Wi-Fi network. Once a Wi-Fi network is saved into memory, the monitor will automatically reconnect to that network as long as the Wi-Fi setting is set to "ON".

**NOTE:** Up to (10) Wi-Fi hotspots can be saved in the memory to the monitor.

## VOXX LINK

Voxx Link is an APP developed for Android and Apple smartphones and tablets that allows full system remote control and visual monitoring of the system without having to directly see or directly touch the monitor. This is a great tool to allow content selection and control of the system for actual users who may be infants and toddlers, too young to control the system themselves.

Download and install the VOXX LINK APP from the Google Play Store or Apple APP Store onto your Android or iOS Smartphone. Scan the QR codes on this page to get direct access to the APPs.

If the system monitor and the device you wish to control the system using Voxx Link are not already connected to the **same** Wi-Fi network, both system monitor and the intended controlling smart device must be connected to the **same** network.

### Example 1 (Using hotspot on smartphone to establish internet/APP access)

1. Turn on your phone's personal hotspot.
2. Connect the system monitor to your phone's hotspot following the Wi-Fi instructions on page 14.
3. Once the system monitor and the smartphone are connected to the **same** network, the smartphone will show as the connected device in the Voxx Link setup menu.

In this setup scenario, the smartphone becomes the gateway to accessing the Internet/APPs and it also becomes the Voxx Link remote control.

### Example 2 (Using a vehicle's built-in hotspot or a portable hotspot device to establish internet/APP access)

1. Turn on the hotspot.
2. Connect the system monitor to the hotspot following the Wi-Fi instructions on page 14.
3. Connect the smart device you wish to control the system with to the hotspot (connect smart device to the hotspot through the smart device Wi-Fi setup).
4. Once the system monitor and the smartphone are connected to the **same** network, the hotspot will show as the connected device in the Voxx Link setup menu.

In this setup scenario, the hotspot becomes the gateway to accessing the Internet/APPs and it also becomes the network for the monitor and the Voxx Link controlling device.

**NOTE:** If the network name does not display on the monitor in the Voxx Link setup menu, press the "Scan" button in the upper right hand corner of the monitor to refresh the list.



Apple Link



Android Link



## VOXX LINK(CONTINUED)

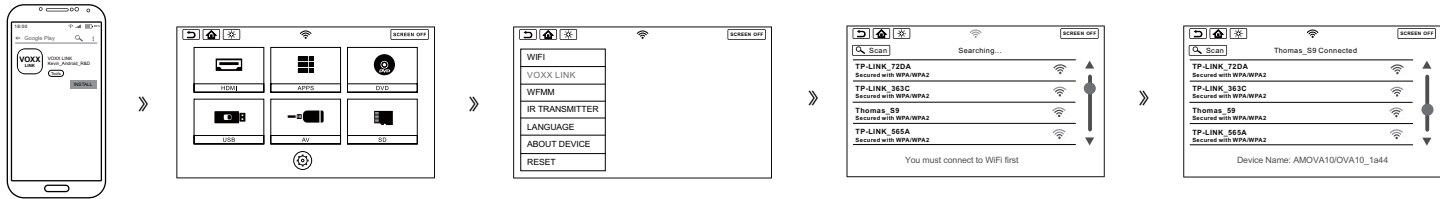

1. Once the network connection is established between the controlling device and the system monitor, open the Voxx Link APP.
2. After the initial splash screen, the monitor will display under "Available Network".
3. Select the monitor you wish to control. Once selected, that monitor's display will appear on the controlling device.
4. To select a different monitor (multiple Overhead Monitor Installation), exit to the controlling device's home screen and go back into the Voxx Link APP to select a different monitor.

### NOTES:

1. In the available network listing, the monitor currently connected to the controlling device will be highlighted in green.

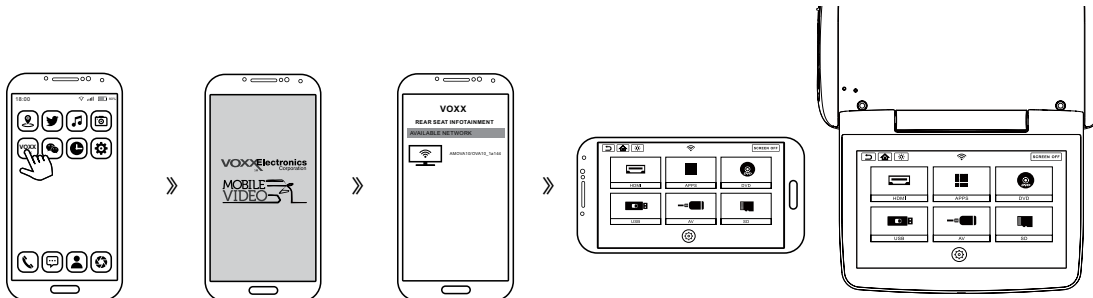

## WFMM(WIRELESS FM MODULATOR)

WFMM allows you to broadcast audio content from the system monitor to your vehicle's factory audio system through an FM station.

1. Select SETUP in the Main Menu.

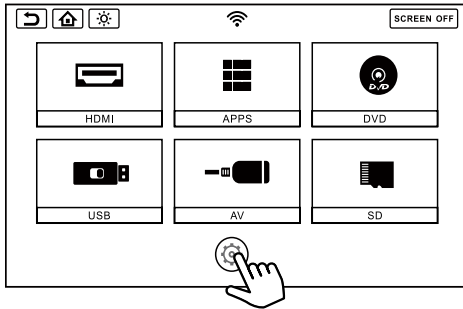

2. Select WFMM inside the SETUP screen.
3. Touch the **ON** button to turn ON the WFMM, Touch the **OFF** button to turn OFF the WFMM.

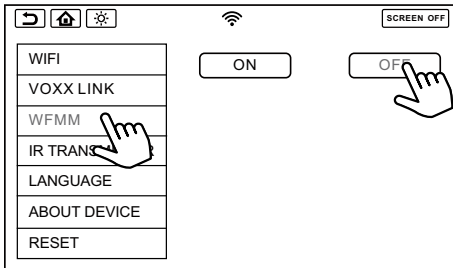

4. Touch the frequency button to select your preferred frequency, and tune your radio FM to the same frequency. This will allow you to listen to the audio from the monitor through your FM Radio.

**NOTE: For best results and to avoid interference, select an FM radio frequency that does not have content broadcasting.**

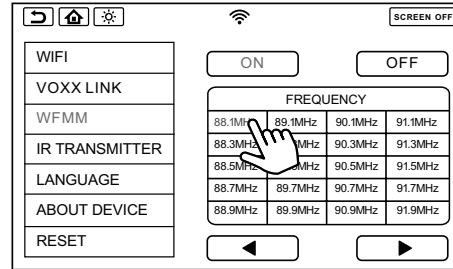

5. Touch the ◀ button to go to the previous page. Touch the ▶ button to go to next page.

**NOTE: There are 100 total frequencies available, with 20 different frequencies on each page.**

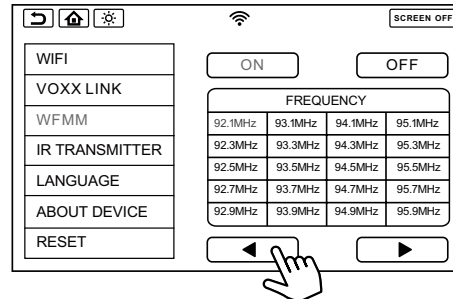

# IR HEADPHONE TRANSMITTER

1. Select SETUP in the Main Menu.

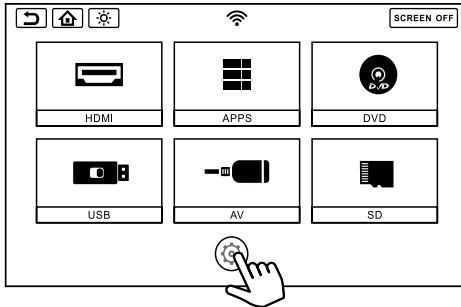

2. Select IR Transmitter inside the SETUP screen.

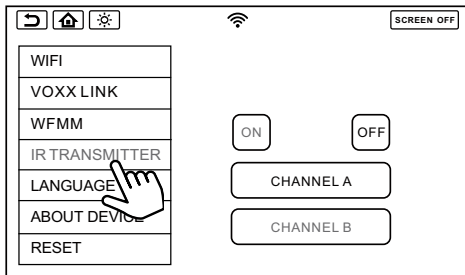

3. Touch the **ON** or **OFF** button to turn ON or OFF the IR Transmitter.

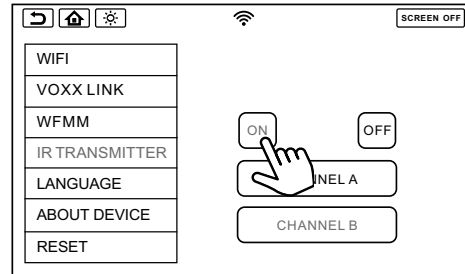

4. Select the desired Channel (A or B) for the IR Transmitter.  
It is recommended to select Channel A for one monitor and Channel B for the other monitor (use for Multiple Overhead monitor installation).

Set the switch on your IR Headphones to channel A or B to listen to the audio from the monitor you prefer. (2 Channel Headphones)

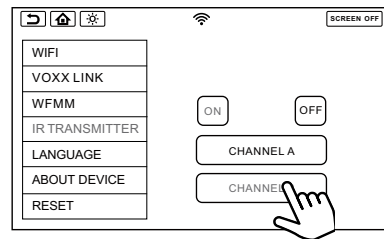

## USER INTERFACE LANGUAGE

1. Select SETUP in the Main Menu.

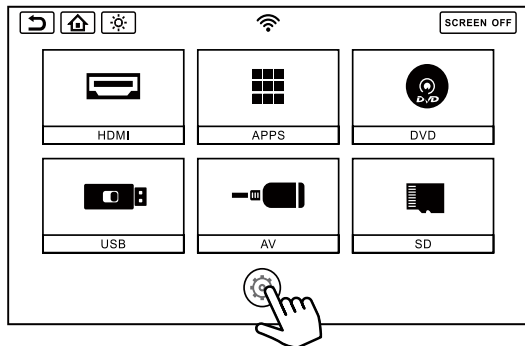

2. Select Language inside the SETUP screen.

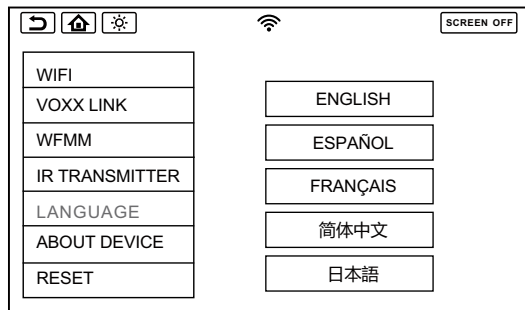

3. Select your preferred language.

## ABOUT DEVICE & CHECK FOR UPDATE

1. Select SETUP in the Main Menu.

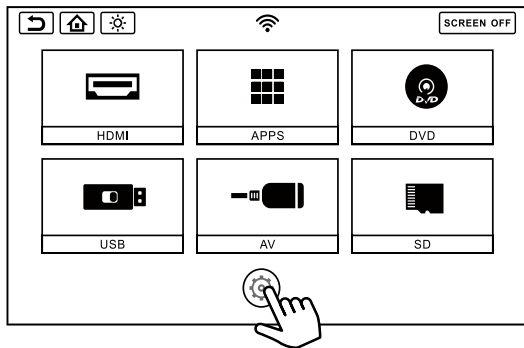

2. Select "ABOUT DEVICE" in the SETUP screen, touch the "CHECK FOR UPDATE" button to check for new software availability.

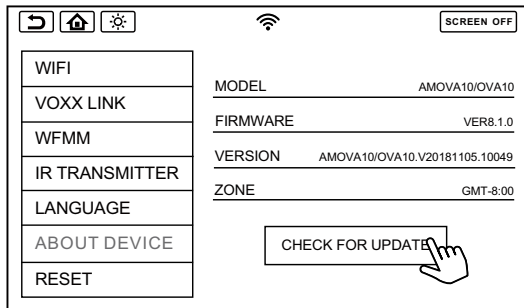

3. A notification message will appear on screen if a software update is available for the monitor.

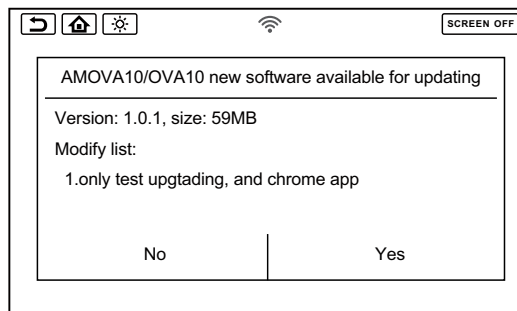

4. Press **Yes** to download the software update, or press **No** to update the software at another time.

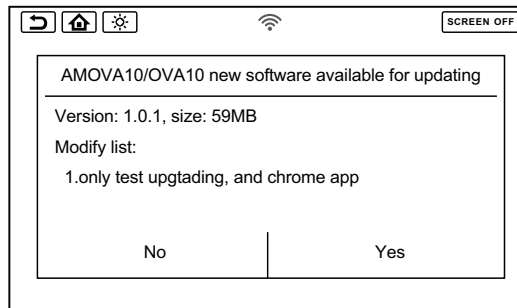

## ABOUT DEVICE & CHECK FOR UPDATE( CONTINUED)

5. This message will appear on the screen if the monitor is not connected to a Wi-Fi hotspot.



6. This message will appear on the screen if the software version is already up to date.

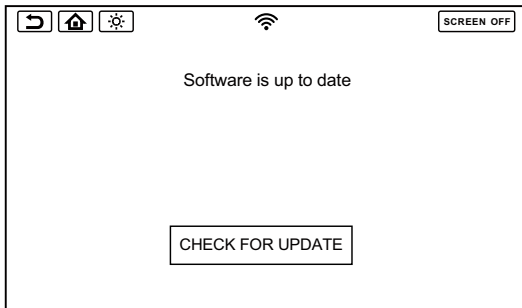

**NOTE:** As long as the system monitor is connected to a Wi-Fi hotspot, the monitor will be able to receive software updates when they become available. It is highly recommended that you update the system monitor whenever an update is made available to ensure your system maintains peak performance. Being a computer-based device, the system will require periodic updates which are managed through "Over-the-Air" software updates. If a software update is available, an "Update Available" message will appear on the home screen of the system monitor.

# TIME ZONE & RESET

## TIME ZONE

1. Select SETUP in the Main Menu.

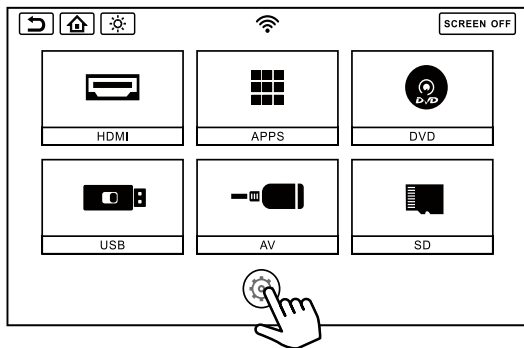

2. Select "ABOUT DEVICE" in the SETUP screen, touch the "ZONE" button to set the time zone to your local time zone.

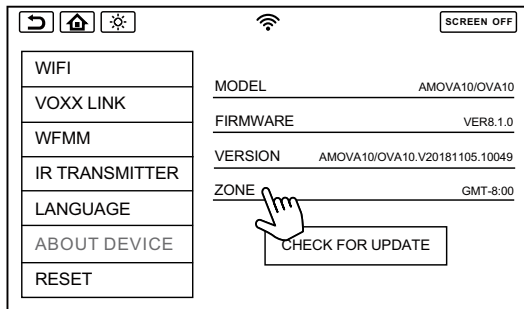

## RESET

1. Select SETUP in the Main Menu.

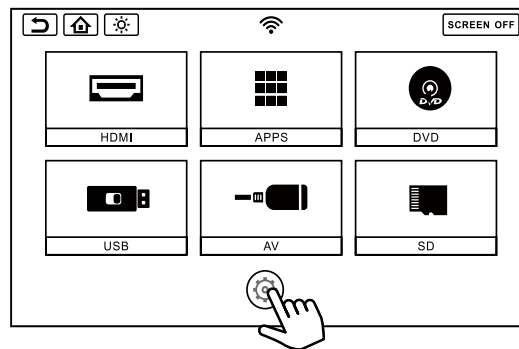

2. Select "RESET" inside the SETUP screen. Touch the "Factory Setting" button to reset all monitor settings back to factory defaults.

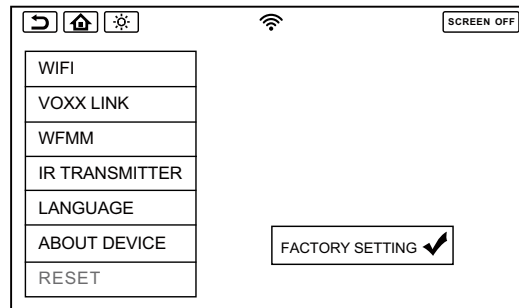

**NOTE:** The RESET function inside the SETUP menu removes all user settings and reverts the system monitor back to their factory default state. The RESET buttons on the side of the monitor resets the system monitor without deleting user settings.

## BRIGHTNESS CONTROL

1. Touch the Brightness Button inside the Info Bar to change the brightness settings.

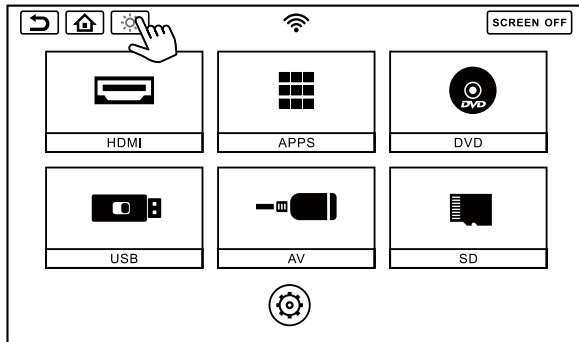

2. Touch and slide the brightness level indicator to the right to increase the brightness, and to the left to decrease the brightness..

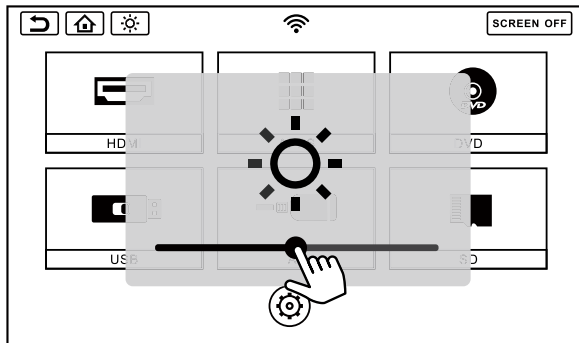



# DVD PLAYBACK

## DVD Region Code

The DVD player is preset to a region code at the factory depending on where the DVD player is sold. A DVD from a different region cannot be played in this unit and the unit will display "WRONG REGION".

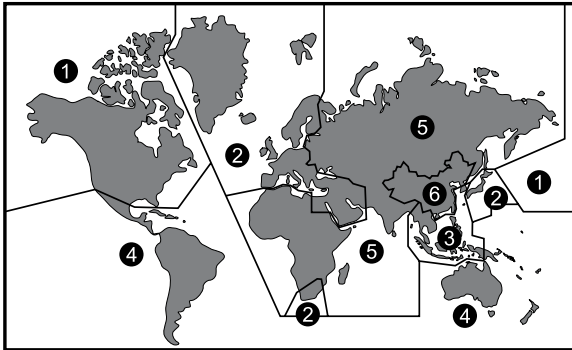

**Region 1-** USA, Canada

**Region 2-** Japan, Europe, South Africa, Middle East, Greenland

**Region 3-** S. Korea, Taiwan, Hong Kong, Parts of South East Asia

**Region 4-** Australia, New Zealand, Latin America (including Mexico)

**Region 5-** Eastern Europe, Russia, India, Africa

**Region 6-** China

## Supported Disc Types

DVD-Video: DVD contains video

DVD +/- R: DVD contains video

CD-DA: CD contains audio

CD-Video: CD contains video

CD-R/RW: CD contains audio

## Unsupported Disc Types

Super Audio CD

Optical disc CD-1

CD-ROM

DVD-ROM

DVD-RAM

DualDisc

DIVX

MiniDisc

AVCHD

HD DVD

**NOTE:** This system is capable of playing most recordable DVD formats. However, due to the variety of disc manufacturers and software, playback cannot be guaranteed.

## Loading Discs

Before a disc is loaded, make sure that it is compatible with the player. Select DVD from the main source and insert a disc with label side facing upwards the user.

## Playing Discs

Once a disc is inserted, playback will automatically begin. If a disc is already inserted, select DVD from the main source menu to resume playback. Touch the screen during playback to display the on-screen controls.

## MEDIA & FILE TYPE COMPATIBILITY

### Media Compatibility

This system is compatible with the media formats listed in the table below.

- The metadata or file information of some audio and video files may not be correctly displayed.
- Some content that is protected by DRM (Digital Rights Management) may be in a format that is not supported by this system.
- There may be a delay before playback begins when using USB flash drives or SD cards with complex folder hierarchies or many files.
- Some audio, video, and image files may be incompatible with this system due to file characteristics, file format, recording software used, directory structure, and/or the type of audio/video encoding used.

### Storage Device Formatting

This system is compatible with the FAT32 format for USB flash drives and micro SD cards up to 64GB. Refer to the documentation that comes with your storage device for more details on how to format.

Supported Formats			
	Format	Extension	Supported Variations/Codecs
VIDEO	AVI	.avi	H.264, MPEG-2 Part 2, MPEG-4 Part 2
	MP4	.mp4, .mov	H.263, H.264, H.265, MPEG-4 Part 2
	Matroska	.mkv	H.264, H.265, MPEG-4 Part 2
	MPEG	.dat, .mpg, .vob	MPEG-1/2
AUDIO	AAC	.m4a, .aac	ADIF, ATDS Header AAC-LC and AAC-HE, AAC-ELD
	ASF	.wma	WMA Version 4, 4.1, 7, 8, 9 @ 8kbps~320Kbps
	FLAC	.flac	Compression Levels 0~8
	AMR	.3gp	AMR-NB, AMR-WB
	MPEG	.mp1, .mp2, .mp3	MPEG-1/2/2.5 Audio Layer 1, 2, 3 @ 8kbps~320Kbps
	OGG	.ogg	Q1~Q10
	WAV	.wav	MS-ADPCM, IMA-ADPCM, PCM
PHOTO	BMP	.bmp	
	GIF	.gif	
	JPEG	.jpg, .jpeg	
	PNG	.png	

## TROUBLESHOOTING

Symptom	Remedy
Monitor does not power on	Verify the vehicle is in the ON/RUN or ACC position. If the Power and Home buttons on the monitor are not illuminated, verify the cable connection to each monitor and/or the power and ground connections to the vehicle.
Monitor frozen - will not respond	Soft reset the monitor by turning each monitor off, then back on again. Hard reset the system by turning the ignition off, then back on, or by activating the reset button on the side of the monitor.
Disc will not play	Check to make sure the disc is inserted with the label side facing upward. Check if the disc is defective by trying another disc. Check the type of disc being played. This unit only plays DVD (Single, Dual Layer), DVD-R/+R, DVD+R Dual layer, DVD-RW/+RW, CD, CD-R, and CD-RW. The unit and the disc are coded by region. If the region codes don't match, the DVD can't be played.
Disc plays, but stops intermittently	The disc may be dirty and need cleaning. Condensation may have formed inside the unit. Remove the disc and allow unit to dry out. The disc may be scratched too badly to play.
DVD playback - distorted picture	Check the disc for fingerprints and clean with a soft cloth, wiping from center to edge.
Cannot advance through a DVD movie	You cannot advance through the opening credits and warning information that appears at the beginning of DVDs because the disc is programmed to prohibit these actions. Some discs may not allow this function. Try another disc.
No sound or distorted sound	Make sure that the external media device is connected properly, and all cables are securely inserted into the appropriate jacks. Verify that the batteries in the wireless headphones are fresh. If you are using the wireless headphones, make sure you turn on the power. Verify the volume is turned up on wireless headphones. Verify nothing is blocking the path between the monitor IR sensor and wireless headphones. When placing the wireless headphones on your head, make sure to observe the Left and Right orientation. The wireless headphones must be oriented correctly (facing forward) to receive the audio signal.
Monitor feels warm	When the monitor is in use for a long period of time, the surface will be warm. This is normal.

## TROUBLESHOOTING(CONTINUED)

Symptom	Remedy
HDMI input not working	Some mobile devices may require a special HDMI cable and/or adapter. Contact your HDMI device supplier for the HDMI cable and/or adapter. Some devices may need to boot up before showing picture. Ensure you are using an OEM branded (Apple, Samsung, etc.) HDMI cable and/or adapters. Generic HDMI cables and/or adapters may not function properly with this system.
Cannot connect monitor to a Wi-Fi network (hotspot)	Check to make sure the correct Wi-Fi network password is used. Refer to page 14 for more details.
Monitor is not registering in the Voxx Link APP	Make sure your smart device has the latest version of the Voxx Link APP installed. Ensure the system monitor and the mobile device are connected to the same Wi-Fi network. Refer to page 17 for more details. Make sure Wi-Fi is turned on in the system menu, then briefly turn the Wi-Fi off then on again.
Cannot play certain files from USB or micro SD cards	Audio/video files embedded with DRM (Digital Rights Management) or copyright protection may not playback on this system. This is not a performance issue, but a limitation that content providers may place on their content. Some USB storage devices and micro SD cards may not be compatible (older USB thumb drives or micro SD cards). Due to ongoing technological advancements, some USB flash drives and micro SD cards may be incompatible with this system.

**NOTE:** The system was designed to satisfy users of every tech level. Specifically related to downloadable APPs available through the Google Play Store, the performance of these APPs is based upon the strength of the Wi-Fi hotspot signal coming into the vehicle in addition to the performance of the APP itself. A poor Wi-Fi connection to the internet can have an impact on content playback that can be mistaken for a performance flaw in the system. Before assuming that the system has a performance issue, please verify that the Wi-Fi signal strength through your hotspot is strong and that all APPs are updated to their latest version. If you believe that the system has a performance issue, please contact Voxx tech at 1-800-645-4994 so that an agent can assist you further in troubleshooting your system.

## GENERAL SPECIFICATIONS

Display Type	10.1" Capacitive Touch Screen, Resolution: 1024 (RGB) x 600
LCD Backlight Type	LED Backlight Life: 20,000 Hours
Supported Disc Types	DVD (Single, Dual Layer), DVD-R/+R, DVD+R Dual layer, DVD-RW/+RW, CD, CD-R, CD-RW
General	Operation Voltage: 10.5VDC ~ 16VDC, Operation Power: 20W max @ 12VDC, Operation Temperature: 32 ~ 131°F (0 ~ 55°C)
Frequency Response	Frequency Response
HDMI Support	Version 1.4b, HDCP 1.4 Compliant
Wireless Headphones	2-Channel Stereo, (Typical Infrared Range: 2.5m)
Wi-Fi Network	802.11a/b/g/n/ac Dual Band
FM Modulation	88.1MHz ~ 107.9MHz
USB Support	Version 1.1, Version 2.0 High Speed, 5 watt (1 Amp) Max Charging Output, 64GB Max Capacity
Micro SD Card Support	SD, SDHC, SDXC, 64GB Max Capacity

## COMPLIANCE INFORMATION

### FCC Notice

This device complies with Part 15 of FCC Rules and Industry Canada license-exempt RSS standard(s). Operation is subject to the following two conditions: (1) this device may not cause interference, and (2) this device must accept any interference, including interference that may cause undesired operation of this device.

This transmitter must not be co-located or operated in conjunction with any other antenna or transmitter. The Bluetooth antenna cannot be removed (or replaced) by user.

Alteration or modifications carried out without appropriate authorization may invalidate the user's right to operate the equipment.

This equipment has been tested and found to comply with the limits for a Class B digital device, pursuant to Part 15 of the FCC Rules. These limits are designed to provide reasonable protection against harmful interference in a residential installation. This equipment generates, uses and can radiate radio frequency energy and, if not installed and used in accordance with the instructions, may cause harmful interference to radio communications. However, there is no guarantee that interference will not occur in a particular installation. If this equipment does cause harmful interference to radio or television reception, which can be determined by turning the equipment off and on, the user is encouraged to try to correct the interference by one or more of the following measures:

- Reorient or relocate the receiving antenna.
- Increase the separation between the equipment and receiver.
- Connect the equipment into an outlet on a circuit different from that to which the receiver is connected.
- Consult the dealer or an experienced radio/ TV technician for help.

### DVD Video Playback

This item incorporates copy protection technology that is protected by U.S. patents and other intellectual property rights of Rovi Corporation. Reverse engineering and disassembly are prohibited.

### AAC

AAC is short for Advanced Audio Coding and refers to an audio compression technology standard used with MPEG-2 and MPEG-4. Several applications can be used to encode AAC files, but file formats and extensions differ depending on the application which is used to encode.

### MP3

Supply of this product only conveys a license for private, non-commercial use and does not convey a license nor imply any right to use this product in any commercial (i.e. revenue-generating) real time broadcasting (terrestrial, satellite, cable and/or any other media), broadcasting/streaming via internet, intranets and/or other networks or in other electronic content distribution systems, such as pay-audio or audio-on-demand applications. An independent license for such use is required. For details, please visit <http://www.mp3licensing.com>.

## COMPLIANCE INFORMATION(CONTINUED)

### FLAC

Copyright © 2000-2009 Josh Coalson

Copyright © 2011-2013 Xiph.Org Foundation

Redistribution and use in source and binary forms, with or without modification, are permitted provided that the following conditions are met:

Redistributions of source code must retain the above copyright notice, this list of conditions and the following disclaimer.

Redistributions in binary form must reproduce the above copyright notice, this list of conditions and the following disclaimer in the documentation and/or other materials provided with the distribution.

Neither the name of the Xiph.org Foundation nor the names of its contributors may be used to endorse or promote products derived from this software without specific prior written permission.

THIS SOFTWARE IS PROVIDED BY THE COPYRIGHT HOLDERS AND CONTRIBUTORS "AS IS" AND ANY EXPRESS OR IMPLIED WARRANTIES, INCLUDING, BUT NOT LIMITED TO, THE IMPLIED WARRANTIES OF MERCHANTABILITY AND FITNESS FOR A PARTICULAR PURPOSE ARE DISCLAIMED. IN NO EVENT SHALL THE FOUNDATION OR CONTRIBUTORS BE LIABLE FOR ANY DIRECT, INDIRECT, INCIDENTAL, SPECIAL, EXEMPLARY, OR CONSEQUENTIAL DAMAGES (INCLUDING, BUT NOT LIMITED TO, PROCUREMENT OF SUBSTITUTE GOODS OR SERVICES; LOSS OF USE, DATA, OR PROFITS; OR BUSINESS INTERRUPTION) HOWEVER CAUSED AND ON ANY THEORY OF LIABILITY, WHETHER IN CONTRACT, STRICT LIABILITY, OR TORT (INCLUDING NEGLIGENCE OR OTHERWISE) ARISING IN ANY WAY OUT OF THE USE OF THIS SOFTWARE, EVEN IF ADVISED OF THE POSSIBILITY OF SUCH DAMAGE.

### SD/SDHC/SDXC

SD, SDHC and SDXC Logos are trademarks or registered trademarks of SD-3C LLC in the United States, other countries or both.

### HDMI

The terms HDMI and HDMI High-Definition Multimedia Interface, and the HDMI Logo are trademarks or registered trademarks of HDMI Licensing, LLC in the United States and other countries.

### Dolby Digital

This product will down-mix Dolby Digital signals internally and the sound will be output in stereo. Manufactured under license from Dolby Laboratories. Dolby and the double-D symbol are trademarks of Dolby Laboratories.

### European Waste Electrical and Electronic Equipment (WEEE) Notice:

In accordance with Directive 2012/19/EU of the European Parliament on waste electrical and electronic equipment (WEEE):

The symbol above indicates that separate collection of electrical and electronic equipment is required. When this product has reached the end of its serviceable life, it cannot be disposed of as unsorted municipal waste. It must be collected and treated separately. It has been determined by the European Parliament that there are potential negative effects on the environment and human health as a result of the presence of hazardous substances in electrical and electronic equipment. It is the users' responsibility to utilize the available collection system to ensure WEEE is properly treated.

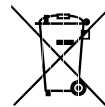

All other trademarks and their respective logos cited herein are the property of their respective owners.



For Customer Service  
Visit Our Website At  
**[www.voxxelectronics.com](http://www.voxxelectronics.com)**  
Product Information, Photos,  
FAQ's, Owner's Manuals

