



STRATUS7 USER GUIDE

Dock & Play Radio



VEHICLE
KIT INCLUDED



Table of Contents

Introduction	4	Configuring Your Stratus 7	59
Features	4	Sirius ID	59
Safety and Care Information	5	Find Available FM Channels in Your Area	60
What's in the Box?	7	Turn FM Transmitter On/Off	63
Stratus 7 Functions	8	Set and Select an FM Channel	64
<i>PowerConnect</i> Vehicle Dock	9	Jump Settings	66
Vehicle Installation	10	Display	67
Step 1: Choose a Location for Your Radio	10	Audio Level	69
Step 2: Install the Vent or Dash Mount	12	Signal	70
Step 3: Mount the Magnetic Mount Antenna	16	Factory Default	71
Step 4: Route the Magnetic Mount Antenna Cable	23	Troubleshooting	72
Step 5: Connect the Magnetic Mount Antenna and <i>PowerConnect</i> Power Adapter	34	Product Specifications	75
Step 6: Connect the Audio	35	Patent and Environmental Information	76
Subscribe	44	FCC Statement	77
Using Your Stratus 7	46	Copyrights and Trademarks	78
The Main Display	46	Owners Record	79
My Channels	47		
Navigation Basics	48		
Listening to Satellite Radio	50		
FM Presets	54		
Special Features	55		
Parental Lock	55		
Where Else Can You Use Your Stratus 7?	58		

Introduction

Features

Congratulations, on your purchase of Stratus 7!

Stratus 7 has these exciting features to enhance your overall experience:

- Easy to read blue display: View artist name, song title, and channel information on an easy to read display.
- Channel guide: View your individual channel lineup by category.
- Improved audio connection options: Use either the included Aux In Cable, or the new *PowerConnect* FM Transmitter to listen to the audio through your vehicle's stereo system.
- Favorite channel presets: Save and enjoy fast access to up to 10 of your favorite channels.
- FM preset button: Store and quickly access FM channels that give you the best audio reception when using *PowerConnect*.
- One-Touch Jump™: Directly access traffic and weather of the 20 most congested cities.
- Parental controls: Easily lock and unlock channels with mature content.

Please read the entire User Guide before using your Stratus 7!

Introduction

Safety and Care Information



IMPORTANT! Self installation instructions and tips are provided for your convenience. It is your responsibility to determine if you have the knowledge, skills, and physical ability required to properly perform an installation. SiriusXM shall have no liability for damage or injury resulting from the installation or use of any SiriusXM or third party products. It is your responsibility to ensure that all products are installed in adherence with local laws and regulations and in such a manner as to allow a vehicle to be operated safely and without distraction. SiriusXM product warranties do not cover the installation, removal or reinstallation of any product.

- Do not expose to extreme temperatures (above 140° F or below -4° F, or above 60° C or below -20° C).
- Do not expose to moisture. Do not use device near or in water. Do not touch the device with wet hands.
- Do not let any foreign matter spill into device.
- Do not store in dusty areas.
- Do not expose to chemicals such as benzene and thinners. Do not use liquid or aerosol cleaners. Clean with a soft damp cloth only.
- Do not expose to direct sunlight for a prolonged period of time, and do not expose to fire, flame, or other heat sources.
- Do not try to disassemble and/or repair device yourself.
- Do not drop your device or subject it to severe impact.
- Do not place heavy objects on device.
- Do not subject device to excessive pressure.
- If the LCD screen is damaged, do not touch the liquid crystal fluid.

Introduction

Warning!

- Opening the case may result in electric shock.
- If the liquid crystal fluid comes in contact with your skin, wipe the skin area with a cloth and then wash the skin thoroughly with soap and running water. If the liquid crystal fluid comes into contact with your eyes, flush the eyes with clean water for at least 15 minutes and seek medical care. If the liquid crystal fluid is ingested, flush your mouth thoroughly with water. Drink large quantities of water, and induce vomiting. Seek medical care.
- Make sure that you insert the *PowerConnect* Power Adapter all the way into the vehicle's cigarette lighter or power adapter socket.
- If you are using *PowerConnect* as your audio connection option, it is advisable not to insert a multi-outlet adapter into the same vehicle cigarette lighter or power adapter socket to simultaneously power other devices. Some multi-outlet adapters can prevent the *PowerConnect* feature from working properly.
- When using this product, it is always important to keep your eyes on the road and hands on the wheel. Not doing so could result in personal injury, death, and/or damage to your device, accessories, and/or to your vehicle or other property.
- Vehicle installation and Radio configuration functions should not be performed while driving. Park your vehicle in a safe location before beginning installation.
- This product contains chemicals known to the State of California to cause cancer and birth defects or other reproductive harm.

Your device should be placed in your vehicle where it will not interfere with the function of safety features, e.g., deployment of airbags. Failure to correctly place device may result in injury to you or others, if the unit becomes detached during an accident and/or obstructs the deployment of an airbag.

Introduction

What's in the Box?

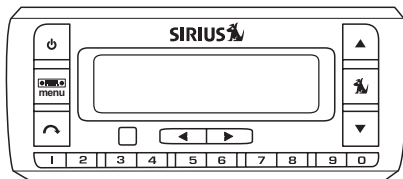

Stratus 7 Radio

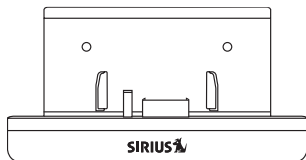

PowerConnect™ Vehicle Dock



Aux In Cable

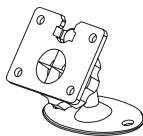

Dash Mount

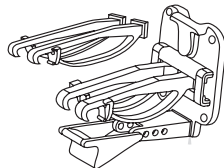

Vent Mount and
Extended Vent
Clamps

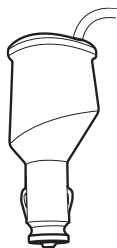

PowerConnect
Power Adapter

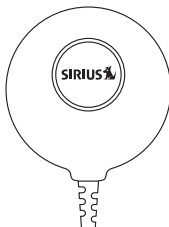

Magnetic Mount
Antenna and Tail



Screws



Antenna & Dash Mount
Alcohol Preparation Pads

Introduction

Stratus 7 Functions

Power Button

Press to turn Stratus 7 on and off.

FM / Menu Button

FM: Press to access and cycle through FM presets.

Menu: Press and hold to access advanced features and configuration options; in configuration options, press and hold to return to main display screen.

Up and Down Buttons

Press to preview and tune channels through the channel lineup; also press to scroll through lists and highlight menu items.

Select Button

Press to confirm selection of highlighted items in a menu or list; when not in a menu or list, press first before entering the channel number, to directly tune to a channel. Press and hold to go back to the previous channel.

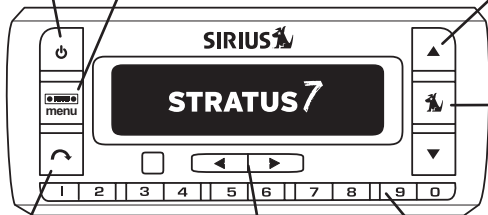

Jump Button

Press to directly access traffic and weather for the city of your choice; or press it to go back to the previous channel to which you were listening.

Left and Right Arrows

Press to search for channels by category.

Number Buttons

Press to tune to a stored favorite channel, press and hold to store a favorite channel; also enter a channel number.

Introduction

PowerConnect Vehicle Dock

Color-Coded Connections

The color-coded *PowerConnect* Vehicle Dock makes it simple to connect. Just match the colors on the cable ends to the colors on the dock to see what goes where.

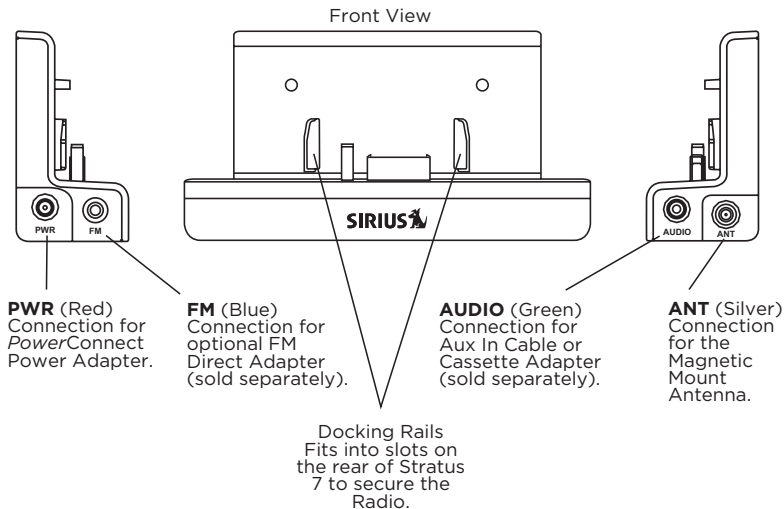

Vehicle Installation



WARNING! DO NOT attempt to install Stratus 7 while driving. Park your vehicle in a safe location before beginning installation.

Step 1: Choose a Location for Your Radio

When installing Stratus 7 in your vehicle, choose a location where it will not block your vision, interfere with the controls, or obstruct any air bags. The location should be easily accessible and provide good visibility of the display, and should not be located where it will be in direct sunlight, which will affect the visibility of the display screen.

Several examples of Stratus 7 mounted in a vehicle are shown: **A** is the on dash method using the Dash Mount, and **B** is the vent clip method using the Vent Mount.

Option 1

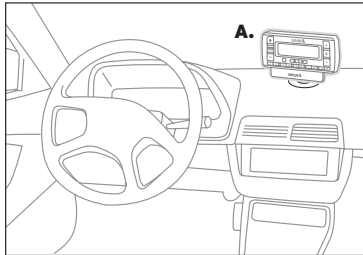

Option 2

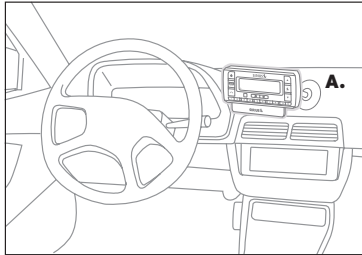

Vehicle Installation

Option 3

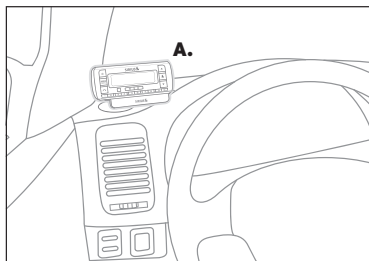

Option 4

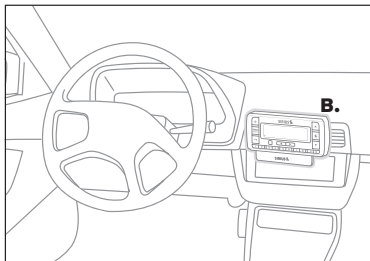

Option 5

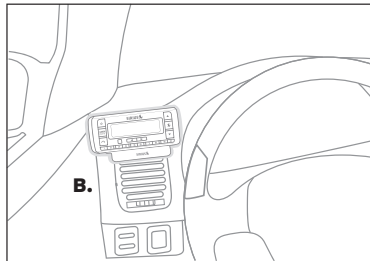

Vehicle Installation

Step 2: Install the Vent or Dash Mount

Follow the instructions on the next several pages for the mounting method you have selected.



NOTE! The *PowerConnect* Vehicle Dock included with Stratus 7 is compatible with the T-slot style Dash and Vent Mounts. If you have an existing Dash Mount or Vent Mount in your vehicle, you can continue to use it with this dock, and skip this step.

Installing the Dash Mount:



CAUTION! The adhesive used on the Dash Mount may be difficult to remove. Do not install this mount on leather surfaces (contact your automobile dealership if you are unsure about your dash surface), and make sure the air temperature is at least 60° F (15° C) during installation. If it's not at least 60° F, turn on the heater in your vehicle to bring the temperature up to 60° F.

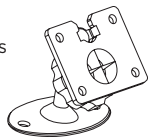

1. Locate a flat surface for the Dash Mount. Make sure there is ample room for the *PowerConnect* Vehicle Dock and Stratus 7 when installed.
2. Set the orientation of the Dash Mount before adhering it. Loosen the knob and adjust the adhesive foot for the location you selected in “Step 1: Choose a Location for Your Radio” on page 10:

- Option 1 & Option 3 should be oriented as **I**.
- Option 2 should be oriented as **II**.

3. The dock mounting plate can be tilted in different directions. Adjust as necessary for your particular

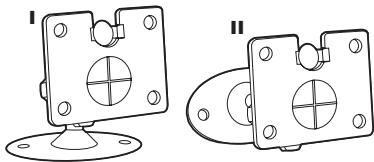

Vehicle Installation

vehicle. When the orientation is correct, tighten the knob.

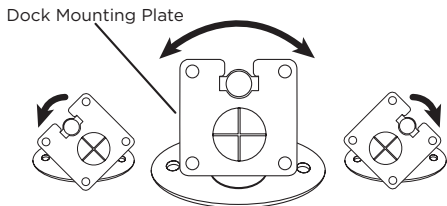
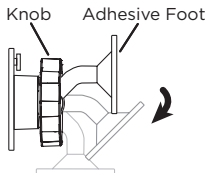

4. Attach the Dash Mount to the *PowerConnect* Vehicle Dock using the 4 provided screws.

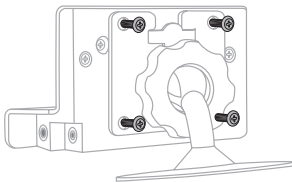

5. Clean the mounting surface in the vehicle with the alcohol preparation pad and let it dry thoroughly.

6. Peel off the adhesive liner. Position, press, and hold the Dash Mount and *PowerConnect* Vehicle Dock in place for 30 seconds.

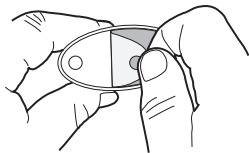

IMPORTANT! Allow the Dash Mount adhesive to cure (dry) for a minimum of 2-4 hours before using the mount. The best adhesion occurs after 24 hours.



TIP! To remove, carefully lift the adhesive pad with your fingers or a spoon. Warming the pad with a hair dryer for several minutes will help soften the adhesive.

Vehicle Installation

Installing the Vent Mount:

1. Locate a vent with horizontal louvers sturdy enough to hold your *PowerConnect Vehicle Dock* and *Stratus 7 Radio*.
2. If the vent louvers in your vehicle are recessed, you may need to use the longer vent clamps with the Vent Mount. If so, Remove the shorter vent clamps and install the longer ones into the Vent Mount. Be sure to observe the orientation of the vent clamps as shown.

Extended Vent Clamps

Short Vent Clamps

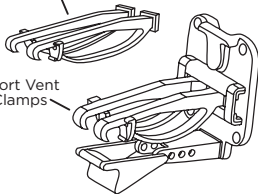

Remove End Cap

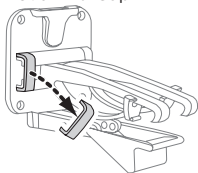

Slide Short Vent Clamps Out

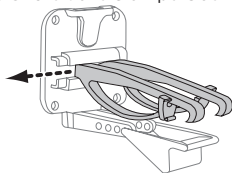

Slide Extended Vent Clamps In

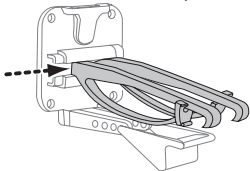

Replace End Cap

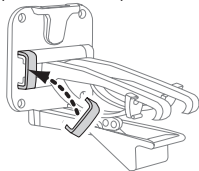

Vehicle Installation

3. Attach the Vent Mount to the *PowerConnect* Vehicle Dock using the 4 provided screws.



Note! For greater clarity, the next illustration does not show the dock attached to the Vent Mount, however, the dock should be attached before continuing.

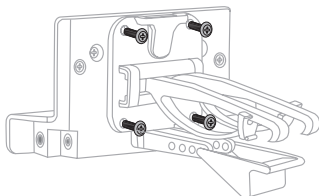

4. Push the Vent Mount onto the vehicle vent as shown (1) until it hooks on the rear of the vent louver (2).

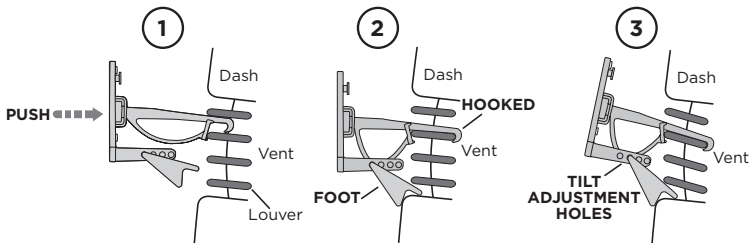

5. Rest the foot against the bottom of the vent (2), and adjust the tilt of the Vent Mount by repositioning the foot to a different adjustment hole (3).



TIP! To remove the Vent Mount, push the mount into the vent. Then lift up until disengaged from the rear of the vent louver, and remove the Vent Mount.

Vehicle Installation

Step 3: Mount the Magnetic Mount Antenna

Mount the Magnetic Mount Antenna on the outside of your vehicle, on a horizontal surface that will always face the sky. The antenna contains a strong magnet which will stick to any metal part of your vehicle, but will not damage the vehicle.

To install the Magnetic Mount Antenna:

1. Choose the best location for your antenna considering your own personal situation. Pay particular attention to any accessories that you may have like luggage racks and how frequently you may use them.

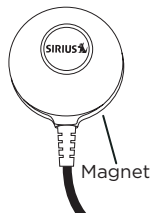

Sedan/Coupe: We recommend mounting the antenna above either the front windshield or the back window as shown.

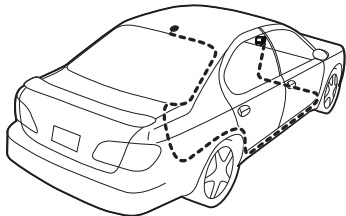
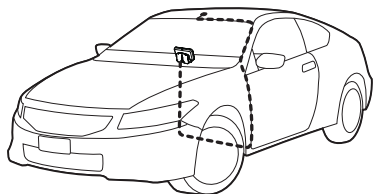

Vehicle Installation

SUV: We recommend mounting the antenna at the rear of the roof as shown.

Convertible: We recommend mounting the antenna at the leading edge of the trunk as shown.

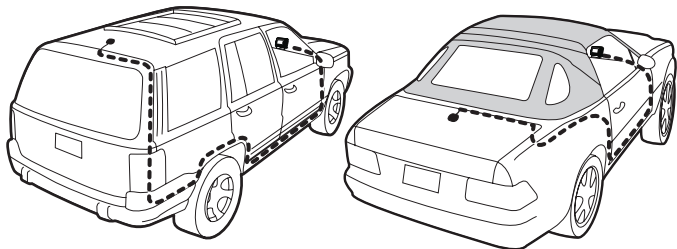

Pickup Truck: We recommend mounting the antenna above the front windshield as shown.



IMPORTANT! Consult a professional installer if your vehicle roof or hood is non-metallic (i.e., fiberglass), or you have difficulty finding a location for your antenna.

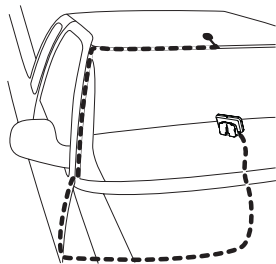

Vehicle Installation

- 2 Attach the Rubber Tail to the antenna and press the antenna cable into the Rubber Tail. The Rubber Tail will help to position the antenna the correct distance from the edge of the roof or trunk lid.
- 3 Clean the surface of the selected mounting location using the alcohol preparation pad and let it dry thoroughly.
- 4 Follow the Tips and Cautions shown on the next several pages, and place the antenna in the location you selected. Peel the protective material from the adhesive strips and press the Rubber Tail firmly into place on the vehicle.
- 5 Continue to press firmly down on the Rubber Tail for another 30 seconds. At room temperature (68° F), maximum adhesion usually occurs within 72 hours. During this period, avoid car washes and other contact with the antenna and the Rubber Tail.

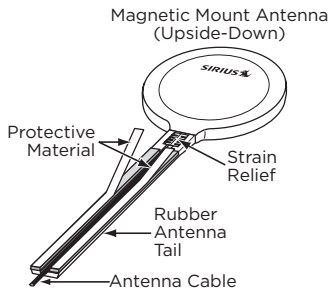

Vehicle Installation

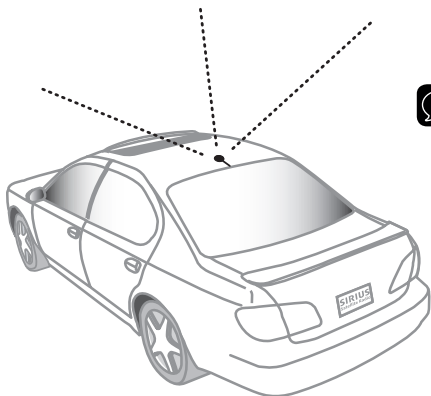

TIP! Mount the antenna on the roof (for most vehicles) or trunk (for convertibles) where it has a clear view of the sky in all directions.

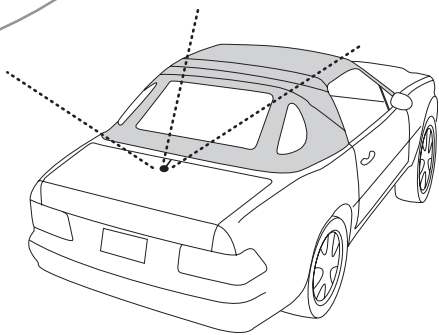

Vehicle Installation



TIP! Mount the antenna on the roof where it has at least 3 inches of clear space around it.

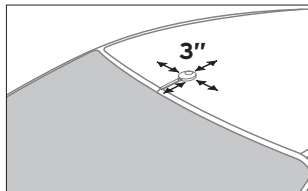

TIP! Use the supplied Rubber Tail to cover and protect the antenna cable.

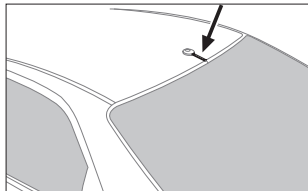

CAUTION! Don't mount the antenna closer than 3 inches from the edge of the roof. Use the supplied Rubber Tail as a guide for judging proper length and correct positioning.

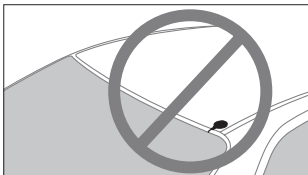

Vehicle Installation



CAUTION! Don't mount the antenna inside the vehicle, for example, on the dashboard.

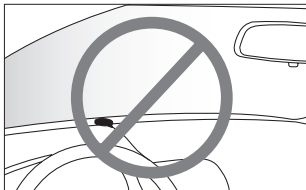

CAUTION! Don't mount the antenna on any of the vehicle's front, back or side pillars.

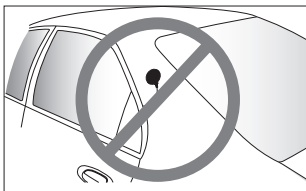

CAUTION! Don't mount the antenna close to a roof rack. Adjust the rack so it's further away from the antenna or move the antenna closer to the center of the roof.

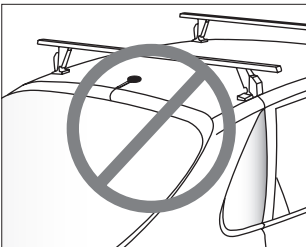

Vehicle Installation



CAUTION! Don't mount the Magnetic Mount Antenna close to another antenna. Mount it at least 3 inches away.

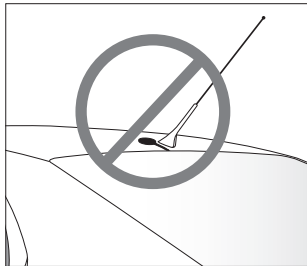

TIP! Always be careful to include enough slack in your cable to accommodate open doors or trunk lids. Use things typically found around the home, like electrical tape, to secure cables in areas so that hinges do not pinch the cable with the door. Hide any excess cable in the trim.

Vehicle Installation

Step 4: Route the Magnetic Mount Antenna Cable

Before you begin routing the antenna cable, read these general instructions for how to route and hide the antenna cable. Then route your antenna cable according to the instructions which follow for your specific type of vehicle.

Use a blunt plastic putty knife, a credit card, a plastic knife, or a similar blunt tool to lift the rubber window moulding

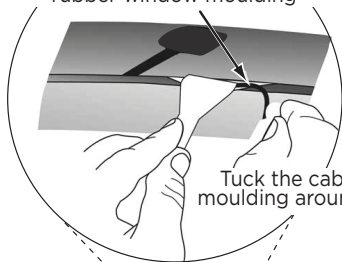

Tuck the cable under the moulding around the window

Feed cable under rubber moulding around window

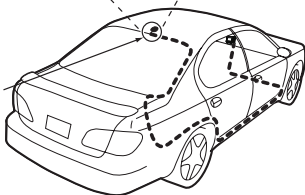

Vehicle Installation

Route cable out from under rear windshield moulding and tuck into weatherstripping around trunk opening
Avoid sharp bends by running cable through weatherstripping for several inches



Tuck cable into weatherstripping. Route cable through weatherstripping several inches to avoid sharp bends

Pull cable out of weatherstripping and route through trunk to cabin

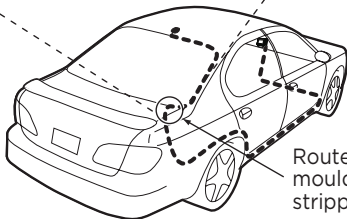
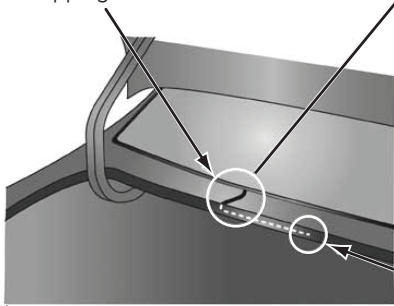

Route cable out of window moulding and into weatherstripping around trunk opening

Vehicle Installation

Bring cable out of weatherstripping and into trunk

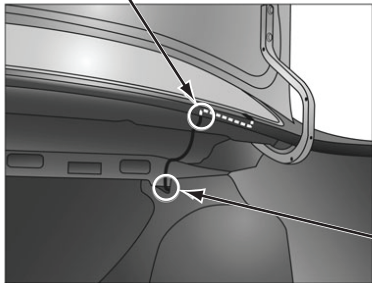

Route cable along trunk wall and into cabin through gap or conduit, along existing wiring harness

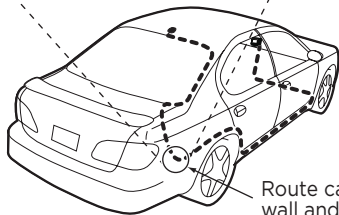

Route cable along trunk wall and into cabin

Vehicle Installation

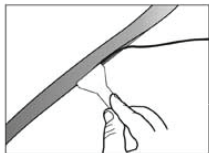

Use a blunt plastic putty knife or similar blunt tool to lift edge of interior trim and tuck cable under trim. Continue towards front of vehicle

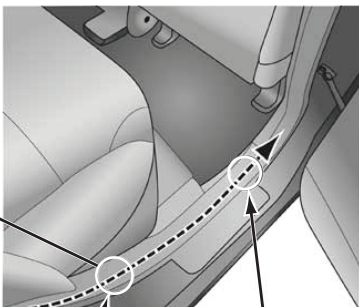

Route cable under trim or upholstery

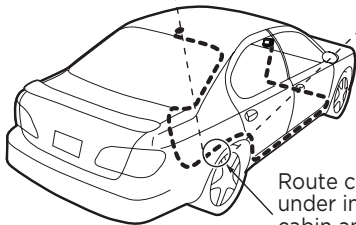

Route cable from trunk under interior trim, into cabin and towards front of vehicle

Continue routing cable under trim or carpet towards front of vehicle

Vehicle Installation

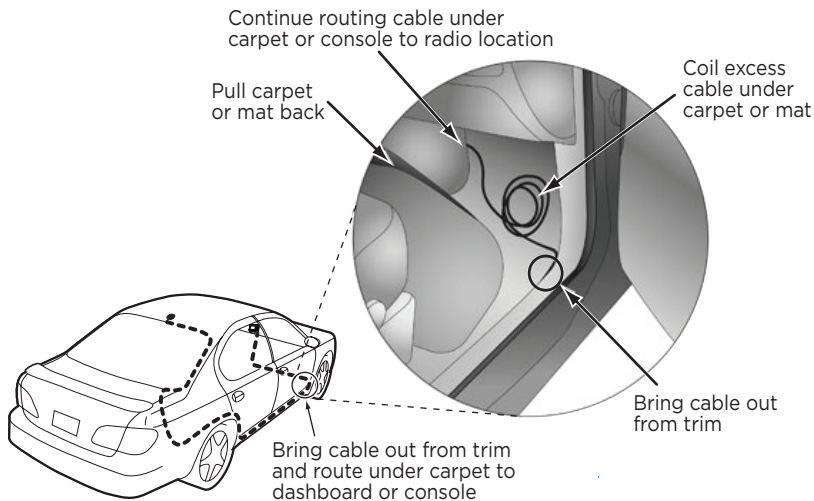

TIP! Always be careful to include enough slack in your cable to accommodate open doors or trunk lids. Use things typically found around the home, like electrical tape, to secure cables in areas so that hinges do not pinch the cable with the door. Hide any excess cable in the trim.

Vehicle Installation

Sedan/Coupe With Antenna Placed at the Rear of the Roof:

- 1.** Feed the antenna cable from the antenna underneath the rubber molding around the rear window. Use a blunt plastic putty knife or similar blunt tool to lift the rubber molding around the rear window and tuck the antenna cable underneath the molding. Route the antenna cable around and down the window to the lowest point. If your rear window does not have rubber molding, we recommend consulting a professional installer.
- 2.** Route the antenna cable out of the window molding and into the rubber weather stripping around the trunk opening. Lift the weather stripping from the opening and tuck the cable inside it, then replace the weather stripping. To avoid sharp bends in the cable, run the cable inside the weather stripping for a few inches, then remove the cable from the weather stripping inside the trunk. Keep the cable away from hinges, gears, etc., that could damage it.
- 3.** Route the cable out from the rubber weather stripping and along the trunk wall. Continue routing the cable into the vehicle cabin through a conduit or along an existing wiring harness.
- 4.** Route the cable through the main cabin area under the interior trim, towards the front of the vehicle. Use a blunt plastic putty knife or similar blunt tool to lift the plastic trim just enough to tuck the cable underneath. Avoid side airbag locations on back

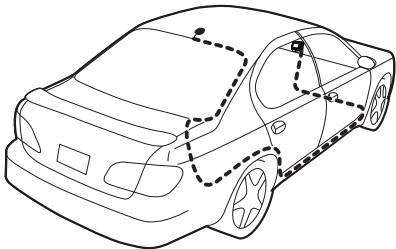

Vehicle Installation

pillars and above the doors. Airbag locations are marked with “SRS” logos. Be careful not to crimp or cut the cable.

5. Bring the cable out from the trim near the front of the cabin and route it under the carpet toward the dashboard or console. Coil any excess cable in a hidden location, such as under the carpet, keeping it away from any vehicle pedals or controls. Secure the excess cable with wire ties (purchased separately).
6. Bring the end of the cable out at the *PowerConnect* Vehicle Dock location. Leave yourself enough cable so you can easily connect it to the antenna connector of the dock.
7. Continue with “Step 5: Connect the Magnetic Mount Antenna and *PowerConnect* Power Adapter” on page 34.

Sedan/Coupe With Antenna Placed at the Front of the Roof:

1. Feed the antenna cable from the antenna underneath the rubber molding around the windshield. Use a blunt plastic putty knife or similar blunt tool to lift the rubber molding around the windshield and tuck the antenna cable underneath the molding. Route the antenna cable around and down the windshield to the lowest point.
2. At the lowest corner of the windshield, route the cable out of the windshield molding and into the rubber weather stripping around the door opening. Lift the weather stripping from the opening and tuck the cable inside it, then replace the weather

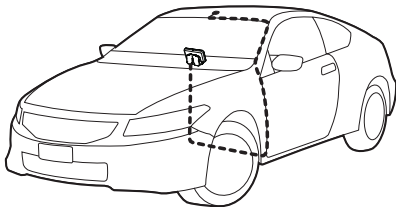

Vehicle Installation

stripping. Run the cable inside of the weather stripping to the bottom of the door opening.

- 3.** Pull the cable out of the weather stripping at the bottom of the door opening and route it under the carpet toward the dashboard. Coil any excess cable in a hidden location, such as under the carpet, keeping it away from any vehicle pedals or controls. Secure the excess cable with wire ties.
- 4.** Bring the end of the cable out at the *PowerConnect* Vehicle Dock location. Leave yourself enough cable so you can easily connect it to the antenna connector of the dock.
- 5.** Continue with “Step 5: Connect the Magnetic Mount Antenna and *PowerConnect* Power Adapter” on page 34.

Sport Utility Vehicle (SUV):

- 1.** Feed the antenna cable underneath the rubber weather stripping of the rear tailgate window/door and route the cable along the rear hatch. Lift the weather stripping from the opening and tuck the cable inside it, then replace the weather stripping. Pull the cable out from weather stripping and route it into the cabin under the interior trim. Avoid hinges or gears that could crimp or cut the cable.
- 2.** Route the cable through the SUV’s main cabin area under the interior trim, towards the front of the vehicle. Use a

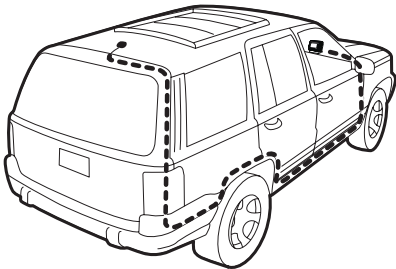

Vehicle Installation

blunt plastic putty knife or similar blunt tool to lift the plastic trim just enough to tuck the cable under underneath. Avoid side airbag locations on back pillars and above the doors. Airbag locations are marked with “SRS” logos. Be careful not to crimp or cut the cable.

3. Bring the cable out from the trim near the front of the cabin and route it under the carpet toward the dashboard or console. Coil any excess cable in a hidden location, such as under the carpet, keeping it away from any vehicle pedals or controls. Secure the excess cable with wire ties (purchased separately).
4. Bring the end of the cable out at the *PowerConnect* Vehicle Dock location. Leave yourself enough cable so you can easily connect it to the antenna connector of the dock.
5. Continue with “Step 5: Connect the Magnetic Mount Antenna and *PowerConnect* Power Adapter” on page 34.

Convertible:

1. Bring the antenna cable from the antenna into the trunk at the front edge of the trunk lid. Keep any bends in the cable loose. Tape or tie the cable along the inside of the trunk lid to the trunk lid hinge strut.
2. Allow enough slack in the cable so the trunk lid can easily open and close and keep the cable away from hinges, gears, etc., that could crimp or cut it. Route the cable along the trunk wall and into the cabin through a conduit or along an existing wiring harness.

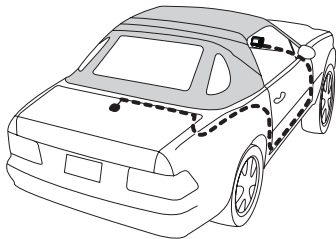

Vehicle Installation

3. Route the cable through the main cabin area under the interior trim, towards the front of the vehicle. Use a blunt plastic putty knife or similar blunt tool to lift the plastic trim just enough to tuck the cable under underneath. Avoid side airbag locations on back pillars and above the doors. Airbag locations are marked with “SRS” logos. Be careful not to crimp or cut the cable.
4. Bring the cable out from the trim near the front of the cabin and route it under the carpet toward the dashboard or console. Coil any excess cable in a hidden location, such as under the carpet, keeping it away from any vehicle pedals or controls. Secure the excess cable with wire ties (purchased separately).
5. Bring the end of the cable out at the *PowerConnect* Vehicle Dock location. Leave yourself enough cable so you can easily connect it to the antenna connector of the dock.
6. Continue with “Step 5: Connect the Magnetic Mount Antenna and *PowerConnect* Power Adapter” on page 34.

Pickup Truck:

1. Use a blunt plastic putty knife or similar blunt tool to lift the rubber molding around the windshield and tuck the antenna cable underneath it.
2. Continue tucking the cable underneath the windshield molding around the windshield to the lowest corner.
3. At the lowest corner of the windshield, route the cable out of the windshield

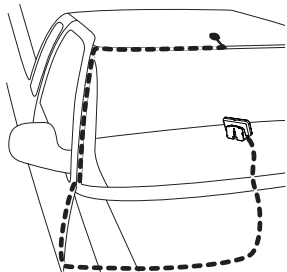

Vehicle Installation

molding and into the rubber weather stripping around the door opening. Lift the weather stripping from the opening and tuck the cable inside it, then replace the weather stripping. Run the cable inside of the weather stripping to the bottom of the door opening.

- 4.** Pull the cable out of the weather stripping at the bottom of the door opening and route it under the carpet toward the dashboard. Coil any excess cable in a hidden location, such as under the carpet, keeping it away from any vehicle pedals or controls. Secure the excess cable with wire ties.
- 5.** Bring the end of the cable out at the *PowerConnect* Vehicle Dock location. Leave yourself enough cable so you can easily connect it to the antenna connector of dock.
- 6.** Continue with “Step 5: Connect the Magnetic Mount Antenna and *PowerConnect* Power Adapter” on page 34.

Vehicle Installation

Step 5: Connect the Magnetic Mount Antenna and PowerConnect Power Adapter

1. Plug the Magnetic Mount Antenna into the **silver ANT** connector on the *PowerConnect* Vehicle Dock.

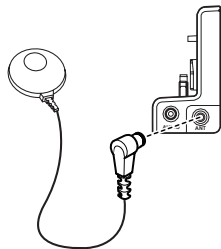

2. Insert the *PowerConnect* Power Adapter into your vehicle's cigarette lighter or power adapter socket.

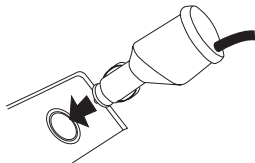

3. Plug the *PowerConnect* Power Adapter into the **red PWR** connector on the dock.

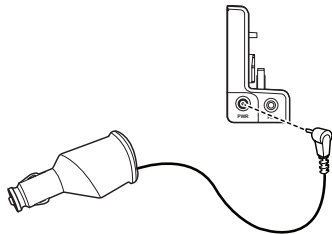

Vehicle Installation

Step 6: Connect the Audio

To play Sirius audio through your vehicle's stereo or FM radio, decide on one of the following audio connection options:

- **Option 1: Best:** Use the included **Aux In Cable** if your vehicle's stereo system has an auxiliary input connection. Refer to your vehicle's owners manual to find the location of the auxiliary input jack, or consult the vehicle dealer.



TIP! The auxiliary input jack may be located on the face plate of the vehicle radio, on the back of the radio, anywhere on the front dash panel, inside the glove compartment, or inside the center console in between the front seats.

- **Option 2: Better:** Use a **Cassette Adapter** if your vehicle has a built-in cassette player. Cassette Adapters are sold separately and can be purchased from an electronics retailer, or go to www.siriusxm.com/accessories.
- **Option 3: Good:** Use the **PowerConnect** feature of Stratus 7. *PowerConnect* plays the audio through your vehicle's FM radio.
- **Option 4: Best:** Use the **FM Direct Adapter**. If none of the previous three audio connection options will work in your vehicle, then you will need to use the FM Direct Adapter (FMDA) (sold separately). The FMDA needs to be installed by a professional installer and directly connects Stratus 7 to your vehicle's FM radio. To learn more, check with the retailer where you bought your Radio, or go to www.siriusxm.com/accessories.

Follow the installation instructions in the next several sections for the audio connection option that you have selected.

Vehicle Installation

Option 1: Aux In Cable Installation Instructions

1. Plug one end of the Aux In Cable into the **green AUDIO** connector on the right side of the dock.

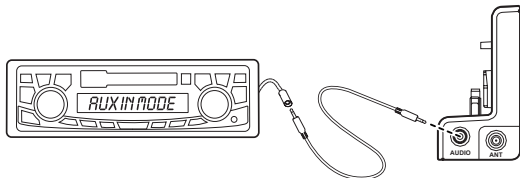

2. Plug the other end into the auxiliary input jack connection of your vehicle's stereo system.
3. Insert your Stratus 7 into the dock, aligning the Radio against the rear of the dock so that the rails on the dock fit into the mounting slots in the back of the Radio.

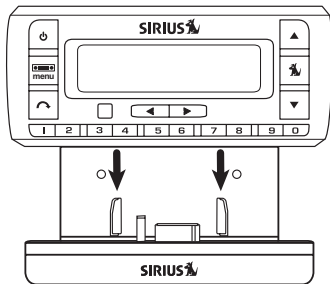

4. Power on your Stratus 7 by pressing the **Power button**.



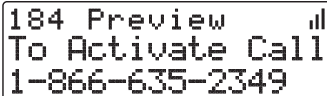

Vehicle Installation

5. Be sure the vehicle is outside and the antenna has a clear view of the sky. Verify that you are receiving the Sirius signal. There should at least be two bars in the upper right corner of the main display screen that denotes antenna signal strength. You can also press and hold **menu** and then press ▼ to scroll to and highlight **Signal**. Press the **Select** button. The Satellite and Terrestrial bars show the strength of the signal being received. If the signal reception is good, press and hold **menu** to return to the main display screen.

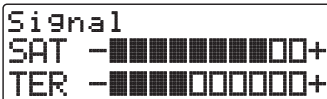

184 Preview 
To Activate Call
1-866-635-2349



Signal
SAT - +
TER - +

6. Ensure that Stratus 7 is tuned to channel 184, the Sirius Preview channel. Upon power up, Stratus 7 should tune to channel 184 by default, when it's not yet activated. If it's not on channel 184, refer to "Listening to Satellite Radio" on page 50 to learn about how to tune a channel.
7. Turn on your vehicle's stereo system. Set it to play input from the auxiliary input source. You should hear Sirius channel 184 through your vehicle's stereo system. You are now ready to activate your Stratus 7.
8. The audio level output of Stratus 7 can be increased or decreased as necessary to match the audio levels of other sources in your vehicle. Refer to "Audio Level" on page 69.

If the signal reception is good, showing at least two bars in the upper right corner of the display, but there is no Sirius audio, be sure the vehicle's stereo system is set to the correct source, i.e., auxiliary input source (step 7). Also be sure that the audio level is set high enough to be heard (step 8). Refer to "Troubleshooting" on page 72 for additional help.

Vehicle Installation

Option 2: Cassette Adapter Installation Instructions

1. Plug the Cassette Adapter into the **green AUDIO** connector on the right side of the dock.
2. Insert the Cassette Adapter in the vehicle's cassette deck. You may need to turn on your vehicle's stereo system in order to do so.

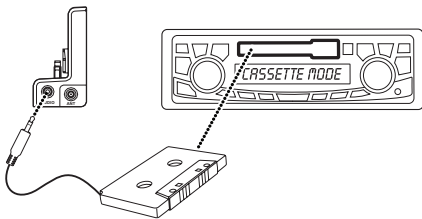

3. Insert your Stratus 7 into the dock, aligning the Radio against the rear of the dock so that the rails on the dock fit into the mounting slots in the back of the Radio.

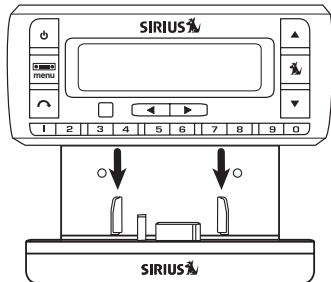

4. Power on your Stratus 7 by pressing the **Power button**.

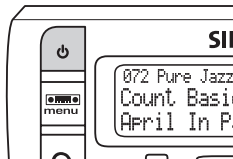

Vehicle Installation

the signal being received. If the signal reception is good, press and hold **menu** to return to the main display screen.

4. You'll first need to find an available FM channel. An available FM channel is one that's not being used by an FM radio station in your area. When you tune your FM radio to an available channel, you should only hear static or silence – not talk or music. We recommend one of the following methods to find an available FM channel:
 - a. Use the SiriusXM FM Channel Finder at **www.siriusxm.com/fmchannel**. Go to the website and enter your zip code. The Channel Finder will suggest a list of available FM channels in your area. For convenience, write down or print out the list.

OR

- b. Manually tune through your local FM channels on your vehicle's FM radio. Locate and create a list of channels that aren't being used by any FM radio station. Write down the list. Once you have created your list of available FM channels, you will need to find the one that provides the best match for your Stratus 7.



TIP! You'll need to use the 'Manual' tune function on your vehicle's FM radio to tune through every FM channel one-by-one. Turn on your vehicle's FM radio. Start at 88.1 and use the 'Manual' tune function on your vehicle's FM radio to tune through each FM channel one-by-one (88.1 followed by 88.3 etc.) to locate channels that aren't being used by a local FM radio station. Write down each FM channel that has only static or silence on it, until you reach 107.9.

5. Ensure that Stratus 7 is tuned to channel 184, the Sirius Preview channel. Upon power up, Stratus 7 should tune to channel 184 by default, when it's not yet activated. If it's not on channel 184, refer to "Listening to Satellite Radio" on page 50 to learn about how to tune a channel.

Vehicle Installation

- Pick the first FM channel on your list from step 4. Turn on your vehicle's FM radio (if you have not already done so) and tune it to this FM channel.



MATCH FM CHANNELS

- Set your Stratus 7 to transmit on the same FM channel that you have selected in step 4:
 - Press and hold **menu** until the menu options are displayed.
 - Press ▼ to scroll to and highlight **FM Settings** and press the **Select button**.
 - FM Channels** will be highlighted. Press the **Select button**.
 - Press ▼ to scroll to and highlight the storage location FM2. Press the **Select button**.
 - Tune to the FM channel you found in step 3. Press ▼ and ▲ to tune in steps of .2, i.e., 99.3 to 99.5. Press ◀ and ▶ to tune in steps of 1, i.e., 99.3 to 100.3. Press the **Select button** to select the FM channel.
 - The FM channel you selected will be confirmed on the display screen. Stratus 7 will tune to the FM channel.
- You should hear Sirius channel 184 through your vehicle's FM radio. If you are satisfied with the sound quality, the installation is complete.

```
FM Channels
>FM2 96.3
FM3 Empty
```

```
FM Channels
96.3 FM
```

Vehicle Installation

You are now ready to activate your Stratus 7.

9. If the selected FM channel doesn't work well for you, work down the list of FM channels until you find one with which you are satisfied. Each time, you will need to tune your vehicle's FM radio to the FM channel and then set your Stratus 7 to transmit on the same FM channel (steps 6 & 7).

If the signal reception is good, showing at least two bars in the upper right corner of the display, but there is no Sirius audio, verify that both Stratus 7 and your vehicle's FM radio are tuned to the same FM channel (steps 6 & 7). Also ensure the chosen FM channel is a suitable one to use in your area (step 4). Verify that nothing is plugged into the **AUDIO** connector on the *PowerConnect* Vehicle Dock. Refer to "Troubleshooting" on page 72 for additional help.

Option 4: FM Direct Adapter (FMDA) Installation

The FMDA needs to be installed by a professional installer. Professional installation can help improve your Radio's reception and significantly reduce the visibility of wires. To learn more, check with the retailer where you bought your Radio, or go to www.siriusxm.com/accessories.

Subscribe

Before you can enjoy Commercial-Free Music, plus Sports, News, Talk & Entertainment, you need to activate your Stratus 7:

1. Make sure your Stratus 7 is turned on, tuned to Sirius Preview channel 184, and receiving the Sirius signal so that you can hear the Sirius audio.
2. When you first turn on Stratus 7, after the startup sequence, the Sirius channel lineup may update. Wait until any channel updates have completed before pressing any buttons. Once the channels have been updated, the Radio will automatically tune to channel 184.
3. Make a note of the Sirius ID. You can find it:
 - by selecting **Sirius ID** in menu items
 - on channel 0 (zero)
 - on a label on the bottom of the gift box
 - on the label on the back of your Stratus 7
4. To subscribe:
 - Online: Go to **www.siriusxm.com/activatenow** to access or set up an online account, subscribe to the service, and activate your Radio.
 - OR
 - By phone: Call **1-866-635-2349**.

Activation usually takes less than 5 minutes, but sometimes may take

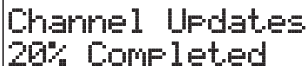

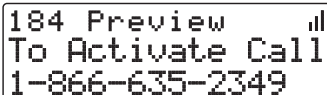

Channel Updates
20% Completed



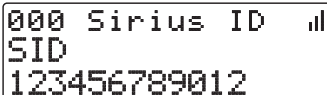

184 Preview 
To Activate Call
1-866-635-2349

*The phone number shown above may differ from the one shown on your Stratus 6. All numbers are valid.

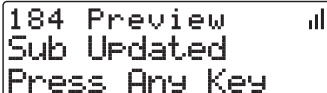

000 Sirius ID 
SID
123456789012



184 Preview 
Sub Updated
Press Any Key

Subscribe

longer. We recommend that your Radio remain on until activated. When your service is activated, your Stratus 7 will display an alert message. To continue, press any button. Once subscribed, Stratus 7 will receive and you can tune to channels in your subscription plan.

Press ▲ or ▼ to tune to other channels, and ◀ or ▶ to browse the different categories of channels. Learn what all the buttons do by turning to “Navigation Basics” on page 48.

Using Your Stratus 7

The Main Display

Whenever you power your Stratus 7 On, it will automatically tune to the last channel you were listening to before it was powered Off. Stratus 7's display screen will show the channel number, the song or show being played, and the artist name of the current channel. This screen is referred to as the main display screen in this guide.

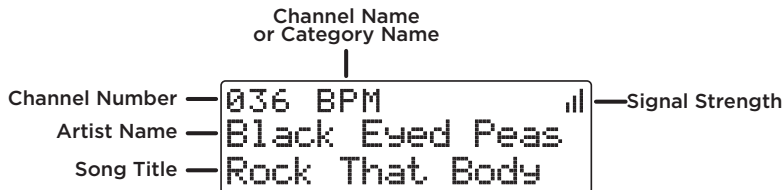

You can also choose to have either the channel name or category name displayed on the main display screen. To pick the mode, press and hold the **menu** button, press the **▼** button to highlight **Display** and press the **Select** button. Press the **▼** button to highlight **Mode** and press the **Select** button. Then choose the desired option. (Refer to “Display” on page 67.)

072 RealJazz |||
Luther Hughes An
Spectacular

Channel Name

072 JzStndrd |||
Luther Hughes An
Spectacular

Category Name

Using Your Stratus 7

My Channels

Channels are organized into categories to make it easier for you to find the ones that suit your taste. My Channels is a special category that displays the channels contained in your subscription plan. You can display this and any category by pressing ◀ or ▶ until the category is displayed.

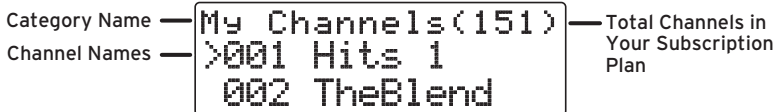

Using Your Stratus 7

Navigation Basics

Power Button

Pressing the **Power button** turns Stratus 7 On or Off.



Navigation Buttons



Use the **Left**, **Right**, **Up**, and **Down** buttons to navigate through various features and functions of Stratus 7.

- **Left ◀ or Right ▶ button:** Displays the channel categories such as Rock, Pop, Sports, Talk/New etc. Repeated presses cycle through the categories one at a time. Decreases or increases the settings of various menu options such as Brightness, Audio Level, etc.
- **Up ▲ or Down ▼ button (press and release):** Immediately tunes to the next or previous channel in the channel lineup. Scrolls through lists and highlights an item in the list.
- **Up ▲ or Down ▼ button (press and hold):** Continuously scrolls through any list. While on the main display screen, continuously scrolls through the channel lineup and briefly displays the information of each channel. When the button is released, the Radio tunes to the last channel it had scrolled to in the channel lineup.

Select Button



The **Select button** selects a highlighted item and confirms settings. At the main display screen, pressing the **Select button** prompts for the entry of a channel number using the number buttons. Once the channel number is entered, the Radio directly tunes to the new channel. At the main display

Using Your Stratus 7

screen, pressing and holding the **Select button** tunes to the previous channel that was being played.

FM/Menu Button



FM provides easy tuning of FM presets for optimized *PowerConnect* performance. Repeatedly pressing **FM** displays and cycles through the list of preset FM channels one at a time. The Radio automatically tunes to the displayed FM channel.

Pressing and holding **menu** displays various options to make setup and feature changes. Pressing **menu** when in menu options returns to the previous menu option screen until menu options is exited. Pressing and holding **menu** when in menu options returns to the main display screen.

Jump Button



When configured properly, pressing **jump** tunes to the channel broadcasting traffic and weather conditions of a selected city, from a list of the 20 most congested cities.

Number Buttons



Each number button stores a favorite channel in its button location and provides one touch access to it afterward. Number buttons also directly tune to a channel when the channel number is entered after pressing the **Select button**.

Using Your Stratus 7

Listening to Satellite Radio

Tune a channel:

1. Press and release ▲ and ▼ to immediately tune to the next or previous channel.
2. Press and hold ▲ and ▼ to speed scroll through the channels. Release to tune to channel which is displayed.

View a category:

Channels are organized into categories to make it easier for you to find the ones that suit your taste.

1. To view a category press ◀ or ▶.
2. Scroll through the channels in the category using ▲ and ▼, and find the channel you want.
3. Press the **Select button** to select the channel, or press ◀ or ▶ for the previous or next category.

```
Pop  
>001 Hits 1  
002 TheBlend
```

```
Rock  
>014 ClsVinyl  
015 ClsRewnd
```

```
Dance/Electronic  
>035 Chill  
036 BPM
```

Using Your Stratus 7

Direct Tune

A channel can be tuned directly by entering the channel number using the number buttons.

1. To directly tune a channel press the **Select button**.



035 Chill ▬▬
Enter Channel

2. Enter the channel number using the buttons **0-9**. Wait a moment until the channel is tuned, or press the **Select button** to immediately tune to the channel.

Using Your Stratus 7

Jump

When configured properly, pressing **jump** will tune to the traffic and weather channel of a selected city, from a list of the 20 most congested cities. This button allows you to quickly tune the traffic/weather broadcast of the selected city, and then tune back to the original channel to which you were listening by pressing **jump** again.

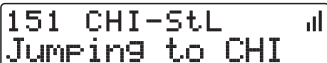

151 CHI-StL 
Jumping to CHI

If the traffic/weather broadcast of your selected city is not immediately available, the display will indicate that a jump is pending. Once the traffic/weather report is ready to be broadcast, the Radio will automatically tune to the traffic/weather channel. Since a channel may carry the traffic and weather reports of more than one city, you may have to wait a few minutes for your desired broadcast.

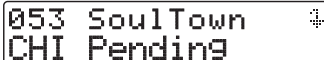

053 SoulTown 
CHI Pending

Pressing the **jump** while a jump is pending will cancel the jump. Pressing **jump** after the Radio has tuned to the traffic/weather channel will return it back to the channel you to which you had been listening immediately prior to pressing **jump**.



TIP! To select a city for traffic/weather, refer to “Jump Settings” on page 66.

Using Your Stratus 7

Returning to main display screen

When changing the Radio options using the menu options, pressing and holding **menu** in most instances will return you to the main display screen. In some instances, you may need to follow the instructions on the display screen.

Favorite Channels

You can set up to 10 of your favorite channels so you can easily access them. Each favorite channel can be assigned to a number button (**0-9**).

To assign a favorite channel to a number button:

1. Tune to the desired channel.
2. Press and hold a number button (**0-9**) for one second, to assign the channel as a favorite.

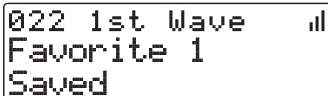
A rectangular box containing a monospaced digital display. The display shows three lines of text: '022 1st Wave' on the top line, 'Favorite 1' on the middle line, and 'Saved' on the bottom line. To the right of the top line, there are three vertical bars of increasing height, representing a signal strength indicator.

To listen to a favorite channel:

1. Press the number button **0-9** that was assigned to the desired favorite channel.

Using Your Stratus 7

FM Presets

FM presets make it easy to quickly access stored FM channels and choose a new FM channel from them.

Use FM presets when you use *PowerConnect* to listen to your Stratus 7 through your vehicle's FM radio.

To start using a different FM preset:

1. Press **FM** to display the current FM channel preset.
2. The currently selected FM preset is shown. To display and select the next FM preset press **FM**.
3. Repeatedly pressing **FM** will cycle through the FM presets. The last displayed FM preset will be tuned. To return to the main display screen, allow the screen to time out.

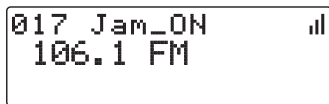

IMPORTANT! You need to ensure that the FM Transmitter in Stratus 7 is turned On, and that your vehicle's FM radio is tuned to the same FM channel.



TIP! To configure the list of preset FM channels, you need to find available FM channels in your area. Refer to "Find Available FM Channels in Your Area" on page 60. Next, refer to "Set and Select an FM Channel" on page 64.

Special Features

Parental Lock

Your Stratus 7 has the ability to lock channels you do not want others (such as children) to access without your permission. Locked channels will not appear in the channel or category list. The default lock code is 0000.

Locked channels can be tuned directly using the 0-9 number buttons and entering the locked channel number. You will be prompted to enter your lock code. If the lock code is correctly entered, the channel will begin playing. If you tune away from the locked channel to a different channel, the locked channel will again be locked.

Changing the lock code:

1. Press and hold **menu** until the menu options are displayed.
2. Press ▼ to scroll to and highlight **Parental Lock** and press the **Select button**.
3. Press ▼ to scroll to and highlight **Change My Code** and press the **Select button**.
4. You will be prompted to enter the existing lock code. The default lock code is 0000. If this is the first time you are changing the lock code, enter **0000**, otherwise enter your lock code. Use the **0-9** number buttons to enter the code and press the **Select button**.
5. Enter a new 4 digit code using the **0-9** number buttons.

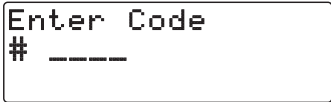

Enter Code



New Code

Special Features

- Once you have entered the code you will then be prompted to enter the new code again to confirm. If you entered the same lock code again, the code is saved.
- Press and hold **menu** to exit.

```
Confirm Code  
# ----
```

```
Confirm Code  
Code Saved
```

To lock or unlock a channel:

- Press and hold **menu** until the menu options are displayed.
- Press ▼ to scroll to and highlight **Parental Lock** and press the **Select button**.
- Lock/Unlock** is highlighted. Press the **Select button**.
- You will be prompted to enter your 4 digit lock code. Enter the lock code using the **0-9** number buttons.
- When you have entered the correct code, a list of channels will be displayed. Press ▼ and ▲ to scroll through the list and highlight a channel you want to lock or unlock.
- Press the **Select button** to lock or unlock a channel. Note that locked channels will display a lock icon  to

```
Parental Lock  
>Lock/Unlock  
Change My Code
```

```
Enter Code  
# ----
```

```
Lock/Unlock  
>104 Raw Dog   
105 LaughUSA
```

Special Features

the right of the channel name.

- 7.** You can continue to select channels for locking or unlocking. When you are finished, press and hold **menu** to exit.

Where Else Can You Use Your Stratus 7?

SiriusXM offers a variety of accessories that allow you to adapt your Stratus 7 Radio to your lifestyle and enhance your listening experience. With these accessories, you can effortlessly take your Satellite Radio listening experience from your vehicle to your home or office or on the go — all with a single subscription.

- In the Home, Office, etc. - With a Home Kit, you can play your Stratus 7 over an existing home, office, or other stereo system.
- In Other Vehicles - With a Vehicle Kit, you can enjoy your Stratus 7 in more than one vehicle.
- In Almost Any Location You Like - With a desktop or portable Sound System you have the freedom to listen to your Stratus 7 where and when you want, from your kitchen or den, to the office, to outside on the deck, or at a picnic.

For more information on Sirius accessories or to purchase an accessory, please visit your local retailer or www.siriusxm.com/accessories.

Configuring Your Stratus 7

Sirius ID

Your Stratus 7 has a numeric 12-digit ID which uniquely identifies the Radio. This ID is used during the activation process.

To display the Sirius ID:

1. Press and hold **menu** until the menu options are displayed.
2. **Sirius ID** will be highlighted. Press the **Select button**. The Radio ID will be displayed.
3. Press and hold **menu** to exit.



```
Sirius ID  
123456789012
```

Configuring Your Stratus 7

Find Available FM Channels in Your Area

Before attempting any of the procedures below, you should park your vehicle in a safe location. Do not attempt to set up your FM channels or any Stratus 7 function while driving.

PowerConnect allows you to listen to Sirius audio through your vehicle's FM radio. You will first need to find an available FM channel, which is a channel that is not being used by an FM radio station in your area. When you tune your FM radio to an available channel, you should only hear static or silence – not talk or music.

Once you have found an available channel, you need to tune Stratus 7's built-in transmitter to the same channel to receive Sirius sound through your vehicle's radio.

We recommend one of the following methods to find an available FM channel:

1. Use the SiriusXM FM Channel Finder

Use the SiriusXM FM Channel Finder at **www.siriusxm.com/fmchannel**. Go to the website and enter your zip code. The Channel Finder will suggest a list of available FM channels in your area. For convenience, write down or print out the list.

Tune Stratus 7 to a favorite Sirius channel (or to channel 184, if it's not yet activated). Turn on your vehicle's FM radio. Pick the first FM channel on your Channel Finder list and tune the FM radio to that channel. If you do not hear a local FM station broadcast, then tune Stratus 7 to the same FM channel. (Refer to "Set and Select an FM Channel" on page 64.) You should hear the Sirius channel through your vehicle's radio. If you are satisfied with

Configuring Your Stratus 7

the sound quality, you're done! If this FM channel doesn't work well for you, work down the list until you find an FM channel that allows you to hear Sirius clearly.

OR

2. Manually tune through your local FM channels

Manually tune through your local FM channels on your vehicle's FM radio. Turn on your vehicle's FM radio. Start at 88.1 and use the 'Manual' tune function on your vehicle's FM radio to tune through each FM channel one-by-one (88.1 followed by 88.3 etc.) to locate channels that aren't being used by a local FM radio station. Write down each FM channel that has only static or silence on it, until you reach 107.9. Once you have created your list of available FM channels, you will need to find the one that provides the best match for Stratus 7.

Tune Stratus 7 to a favorite Sirius channel (or to channel 184, if it's not yet activated). Pick the first FM channel on your list and tune the FM radio to that channel. Then tune Stratus 7 to the same FM channel. (Refer to "Set and Select an FM Channel" on page 64.) You should hear the Sirius channel through your vehicle's radio. If you are satisfied with the sound quality, you're done! If this FM channel doesn't work well for you, work down the list until you find an FM channel that allows you to hear Sirius clearly.



NOTE! You may find an FM channel with static or silence that does not work with Stratus 7. It is possible that some type of inaudible interference is present that prevents reception of Stratus 7 broadcast. Your only options are to use another FM channel or a different audio connection method.

Configuring Your Stratus 7



TIP! If you regularly drive from one location to another, such as your daily commute, you may need to use different FM channels along your route for best performance. If this is the case, we recommend saving the best FM channels as presets on your FM radio and Stratus 7. Then you simply select and match the best channel for the area you are in.



TIP! It will be much more difficult to find available FM channels in large cities than in most suburban or rural locations. A direct audio connection using the Aux In Cable, Cassette Adapter, or professional installation is your best solution if you drive in or near large metropolitan areas.



NOTE! The SiriusXM FM Channel Finder relies on data from the Federal Communications Commission. The data may not reflect the latest stations in your area. In addition, local geography and weather conditions can impact reception, so your results may be different from the list.



NOTE! The performance of FM radios are different, based on manufacturer and vehicle style. Some may not work well with the type of FM transmitter used by Stratus 7. This is why we recommend a direct audio connection using the Aux In Cable or Cassette Adapter if they can be used in your vehicle. Professional installation can also resolve almost any performance issue.

Configuring Your Stratus 7

Turn FM Transmitter On/Off

The built-in FM Transmitter in Stratus 7 works with the *PowerConnect* Vehicle Dock, and is used when you choose to listen to Stratus 7 through your vehicle's FM radio.

To turn the FM Transmitter On or Off:

1. Press and hold **menu** until the menu options are displayed.
2. Press ▼ to scroll to and highlight **FM Settings** and press the **Select** button.
3. Press ▼ to scroll to and highlight **FM Transmitter** and press the **Select** button.
4. Press either ▼ or ▲ to scroll to and highlight either **On** or **Off** and press the **Select** button.
5. Press and hold **menu** to exit.

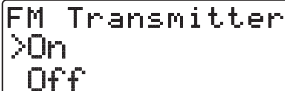

```
FM Transmitter
>On
Off
```



TIP! Stratus 7 is shipped with the FM Transmitter turned On by default.



TIP! The FM1 storage location is preset with FM channel 97.9.

Configuring Your Stratus 7

Set and Select an FM Channel

Stratus 7 allows you to easily store (i.e., preset) up to 5 different FM channels. At any time, you can select any one of these 5 FM presets to transmit audio from Stratus 7 to your vehicle's FM radio. Having a choice of 5 FM presets also makes it easy to switch to the appropriate FM channel as you travel from one area to another. Each FM preset is stored in its own storage location. You can easily add or edit the FM preset in any one of the 5 storage locations.



TIP! The FM1 storage location is preset with FM channel 97.9.

To set an FM preset:

1. Press and hold **menu** until the menu options are displayed.
2. Press ▼ to scroll to and highlight **FM Settings** and press the **Select button**.
3. **FM Channels** will be highlighted. Press the **Select button**.
4. Press ▼ to scroll to and highlight the storage location (FM1 to FM5) that you want to set or select, and press the **Select button**.
5. Change the FM Channel for the selected storage location by pressing ▼ and ▲ to tune in steps of .2, i.e., 99.3 to 99.5, and pressing ◀ and ▶ to tune in steps of 1, i.e., 99.3 to 100.3. Press the **Select button** to select the

```
FM Channels
>FM1 97.9
FM2 Empty
```

```
FM Channels
96.3 FM
```

Configuring Your Stratus 7

FM channel. The FM channel you selected will be confirmed on the display screen and Stratus 7 will tune to the FM channel.

- 6 Set your vehicle's FM radio to same FM channel.



IMPORTANT! You first need to find available FM channels in your area. Refer to "Find Available FM Channels in Your Area" on page 60.

To quickly select an FM channel from the preset list:

1. Press **FM** to display the current FM channel preset.
2. The currently selected FM preset is shown. To display and select the next FM preset press **FM**.
3. Repeatedly pressing **FM** will cycle through the FM presets. The FM channel displayed will be selected. To return to the main display screen, allow the screen to time out.
4. Set your vehicle's FM radio to the same FM channel.

017 Jam_ON
97.9 FM

017 Jam_ON
106.1 FM

Configuring Your Stratus 7

Jump Settings

Jump can be set to jump to the traffic and weather channel of one of the 20 most congested cities. You'll need to select the desired city from the list.

To configure jump:

1. Press and hold **menu** until the menu options are displayed.
2. Press ▼ to scroll to and highlight **Jump Settings** and press the **Select button**.
3. A list of cities will be displayed. Press ▼ or ▲ to scroll to and highlight your desired location and press the **Select button**.
4. Press and hold **menu** to exit.

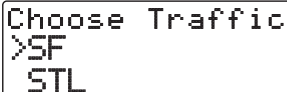

```
Choose Traffic
>SF
STL
```

Configuring Your Stratus 7

Display

The Display option allows you adjust the brightness and contrast of Stratus 7's display to improve its visibility in different lighting conditions. You also can set the mode of the display screen to show channel name or category name information.

To change the display's brightness or contrast:

1. Press and hold **menu** until the menu options are displayed.
2. Press ▼ to scroll to and highlight **Display** and press the **Select button**.
3. Press the **Select button** to choose **Brightness** or press ▼ to scroll to and highlight **Contrast** and press the **Select button**.
4. Press ◀ or ▶ to decrease or increase the brightness/contrast of the display.
5. Press the **Select button** to confirm the brightness setting.
6. Press and hold **menu** to exit.



Configuring Your Stratus 7

To change the display screen mode:

1. Press and hold **menu** until the menu options are displayed.
2. Press ▼ to scroll to and highlight **Display** and press the **Select** button.
3. Press ▼ to scroll to and highlight **Mode** and press the **Select** button.
4. Press ▼ or ▲ to scroll to and highlight **Channel Name** or **Category Name** and press the **Select** button.

```
Mode
>Channel Name
  Category Name
```

Channel Name displays the name of the channel at the top of the display screen, and Category Name displays the name of the category for the currently tuned channel.

```
072 RealJazz  al
Luther Hughes An
Spectacular
```

Channel Name

```
072 JzStndrd  al
Luther Hughes An
Spectacular
```

Category Name

5. Press and hold **menu** to exit.

Configuring Your Stratus 7

Audio Level

The audio level of Stratus 7 can be adjusted when an audio connection is made between the dock and the vehicle's stereo system. Audio level is used to adjust Stratus 7's volume level to match the volume of other audio sources you may use, such as a CD player, other FM stations, or an MP3 player.

Do not use the audio level as a volume control. Use the volume control on your vehicle stereo instead.

To adjust the audio level:

1. Press and hold **menu** until the menu options are displayed.
2. Press ▼ to scroll to and highlight **Audio Level** and press the **Select button**.
3. Press ◀ to decrease or ▶ to increase the audio level.
4. Press the **Select button** to confirm the new audio level setting.
5. Press and hold **menu** to exit.



Configuring Your Stratus 7

Signal

For best reception, your Magnetic Mount Antenna should have an unobstructed view of the Sirius satellites. In large cities, terrestrial transmitters (ground repeaters) help increase the signal coverage.

Your Stratus 7 can display the received strength of the satellite and terrestrial signals being received.

To display the signal strength:

Press and hold **menu** until the menu options are displayed.

1. Press and hold **menu** until the menu options are displayed.
2. Press ▼ to scroll to and highlight **Signal** and press the **Select button**.
3. The Satellite and Terrestrial bars show the strength of the signal being received.
4. Reposition the antenna if you are having trouble getting a signal. Be sure your vehicle is outside with an unobstructed view of the sky.
5. Press and hold **menu** to exit.

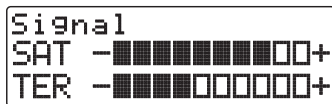

Configuring Your Stratus 7

Factory Default

You can clear all of your personal settings, such as favorite channels, and return the Radio to its original out-of-the-box settings.

To restore Stratus 7 to the factory defaults:



NOTE! Restoring defaults permanently removes all personal settings.

1. Press and hold **menu** until the menu options are displayed.
2. Press ▼ to scroll to and highlight **Factory Default** and press the **Select button**.
3. Press ▲ to scroll to and highlight **Yes** and press the **Select button**.
4. A warning screen will be displayed. If you are certain that you want to reset your Stratus 7 to the factory defaults, press ▲ to scroll to and highlight **Yes** and press the **Select button**.
5. The Radio will display **Restoring**, and will be restored to the factory settings.
6. Press and hold **menu** to exit.

```
Restore?  
Yes  
>No
```

```
Are You Sure?  
Yes  
>No
```

```
Restoring
```

Troubleshooting

Stratus 7 has been designed and built to be trouble-free but if you experience a problem, try this:

- Check that all connections are firm and secure.
- Make sure the vehicle power socket is clean and free of corrosion.
- Make sure you have connected Stratus 7 as described in this User Guide. Verify that the *PowerConnect* Power Adapter is plugged into the vehicle's cigarette lighter or power adapter socket, and that the LED on the *PowerConnect* Power Adapter is lit (on). If not, your vehicle may need to be running to provide power to the socket.

If you see this on the screen:	Try this:
Acquiring Signal	<ul style="list-style-type: none">• Make sure that the vehicle is outdoors with a clear view of the sky.• Make sure the Magnetic Mount Antenna is mounted outside of the vehicle.• Move your Magnetic Mount Antenna away from any obstructed area. For example, if you are parked in an underground garage, you should receive a signal after leaving the garage.
Check Antenna Connection	<ul style="list-style-type: none">• Make sure that the antenna cable is firmly and securely plugged into the <i>PowerConnect</i> Vehicle Dock. Make sure the cable is not bent or broken.• Turn Stratus 7 Off, then On, to reset this message.• If the message persists, most likely the Magnetic Mount Antenna cable has been damaged. Replace the antenna.

Troubleshooting

If you see this on the screen:	Try this:
Invalid Channel	<ul style="list-style-type: none">• You have attempted to tune to a channel that you have not subscribed to, or does not exist. Select a channel to which you have subscribed.
Firmware Updating	<ul style="list-style-type: none">• Your Stratus 7 is being updated over the air with the latest software. Wait until the update is done.
If this happens:	Try this:
You do not receive all the channels to which you have subscribed	<ul style="list-style-type: none">• Ensure that you have followed the proper activation process. Refer to “Subscribe” on page 44.• Call 1-888-539-7474 for further assistance.
Audio sounds too soft	<ul style="list-style-type: none">• Raise the volume of your stereo system or increase the audio level of your Stratus 7 until the sound quality improves. Refer to “Audio Level” on page 69.
No audio when using the Aux In Cable or Cassette Adapter	<ul style="list-style-type: none">• Check all cables between your Stratus 7 and your vehicle’s stereo system for a firm and secure connection.• Ensure you have selected the proper input source on your vehicle’s stereo system.• Increase the audio level of your Stratus 7 until the sound quality improves. Refer to “Audio Level” on page 69.
No audio when using <i>PowerConnect</i> or <i>FMDA</i>	<ul style="list-style-type: none">• Check that your Stratus 7 and your vehicle’s FM radio are tuned to the same FM channel.• For <i>PowerConnect</i>, ensure you are using the <i>PowerConnect</i> Vehicle Dock and <i>PowerConnect</i> Power Adapter.

Troubleshooting

If this happens:	Try this:
Audio fades or has static when listening	<ul style="list-style-type: none">• Check all cables for a firm and secure connection.• If you are using <i>PowerConnect</i> to listen via your vehicle's FM radio, and the problem persists, it most likely is interference from another commercial or broadcast FM station. You will need to find an unused or available FM channel in your area. Refer to "Find Available FM Channels in Your Area" on page 60.• If you are using <i>PowerConnect</i>, and you cannot solve the audio problem, try connecting the audio using the Aux In Cable or a Cassette Adapter. (Refer to page 36 and page 38.) If you cannot use those solutions, consider using an FM Direct Adapter. (Refer to page 43.)
No song title or artist name is displayed	<ul style="list-style-type: none">• The information may not be available or updates may be in progress.
Traffic and Weather channels sound different from other channels	<ul style="list-style-type: none">• These channels use a different audio technology than other channels so they often sound different from other channels.

Product Specifications

System

Power Requirements:	9-16 V DC, 500 mA (max)
Operating Temperature:	-4° F to +140° F (-20° C to +60° C)
Audio Output:	1.0 V _{rms} (max)

Stratus 7 Radio

Dimensions:	4.5 in (W) x 1.9 in (H) x 0.7 in (D) 115 mm (W) x 48 mm (H) x 17 mm (D)
Weight:	2.3 oz (66 g)

PowerConnect Vehicle Dock

Dimensions:	4.0 in (W) x 2.6 in (H) x 1.2 in (D) 102 mm (W) x 65 mm (H) x 31 mm (D)
Weight:	1.6 oz (46 g)
Audio Connector:	1/8 in (3.5 mm) female
Antenna Connector:	SMB male

PowerConnect Power Adapter

Dimensions:	3.7 in (W) x 1.7 in (H) x 1.3 in (D) 94 mm (W) x 43 mm (H) x 34 mm (D)
Weight:	2.4 oz (69 g)
Input / Output:	9-16 V DC / 5 V DC, 1.5 A
Cable Length:	4 ft 7 in (1.4 m)

Vehicle Antenna

Type:	Sirius Magnetic Mount
Connector:	SMB female, right angle
Cable Length:	21 ft (6.4 m)

Aux In Cable

Connectors:	1/8 in (3.5 mm) stereo male to 1/8 in (3.5 mm) stereo male
Cable Length:	4 ft (1.2 m)

Patent and Environmental Information

Patent Information

It is prohibited to, and you agree that you will not, copy, decompile, disassemble, reverse engineer, hack, manipulate, or otherwise access and/or make available any technology incorporated in this product. Furthermore, the AMBE® voice compression software included in this product is protected by intellectual property rights including patent rights, copyrights, and trade secrets of Digital Voice Systems, Inc. The software is licensed solely for use within this product. The music, talk, news, entertainment, data, and other content on the Services are protected by copyright and other intellectual property laws and all ownership rights remain with the respective content and data service providers. You are prohibited from any export of the content and/or data (or derivative thereof) except in compliance with applicable export laws, rules and regulations. The user of this or any other software contained in a Sirius XM Radio Inc is explicitly prohibited from attempting to copy, decompile, reverse engineer, hack, manipulate or disassemble the object code, or in any other way convert the object code into human-readable form.

Environmental Information

Follow local guidelines for waste disposal when discarding packaging and electronic appliances.

Perchlorate Material - special handling may apply. See www.dtsc.ca.gov/hazardouswaste/perchlorate (Applicable to California, U.S.A.)

FCC Statement

The user is cautioned that changes or modifications not expressly approved by Sirius XM Radio Inc. can void the user's authority to operate this device.

This device complies with Part 15 of the FCC Rules. Operation is subject to the following two conditions:

1. This device may not cause harmful interference.
2. This device must accept any interference received, including interference that may cause undesired operation.

This equipment has been tested and found to comply with the limits for a Class B digital device, pursuant to Part 15 of the FCC Rules. These limits are designed to provide reasonable protection against harmful interference in a residential installation.

This equipment generates, uses, and can radiate radio frequency energy and, if not installed and used in accordance with the installation instructions, may cause harmful interference to radio communications. However, there is no guarantee that interference will not occur in a particular installation. If this equipment does cause harmful interference to radio or television reception, which can be determined by turning the equipment off and on, the user is encouraged to try to correct the interference by one or more of the following measures:

- Reorient or relocate the receiving antenna of the affected receiver.
- Increase the separation between the SiriusXM equipment and the affected receiver.
- Connect the SiriusXM equipment into an outlet on a circuit different from that to which the affected receiver is connected.
- Consult the dealer or an experienced radio/TV technician for help.

WARNING! The FCC and FAA have not certified this Satellite Radio Receiver for use in any aircraft (neither portable nor permanent installation). Therefore, Sirius XM Radio Inc. cannot support this type of application or installation.

Copyrights and Trademarks

© 2013 Sirius XM Radio Inc. “Sirius”, “XM” and all related marks and logos are trademarks of Sirius XM Radio Inc. and its subsidiaries. “BBC” and “Radio One” are trademarks of the British Broadcasting Corporation and are used under license. BBC logo © BBC 1996. Radio 1 logo © BBC 2001. Cosmopolitan® is a registered trademark of Hearst Communications, Inc. Elvis Radio logo © EPE Reg. U.S. Pat & TM off. IndyCar (and Design) are registered trademarks of Brickyard Trademarks, Inc., used with permission. Major League Baseball trademarks and copyrights are used with permission of Major League Baseball Properties, Inc. Visit the official website at MLB.com. Games subject to availability and change and may not include all spring training games. All rights reserved. NASCAR® is a registered trademark of the National Association for Stock Car Auto Racing, Inc. The NBA identifications are the intellectual property of NBA Properties, Inc. and the respective NBA member teams. © 2013 NBA Properties, Inc. © 2013 NFL Properties LLC. All NFL-related trademarks are trademarks of the National Football League. NHL and the NHL Shield are registered trademarks of the National Hockey League. © NHL 2013. All NHL logos and marks and NHL team logos and marks depicted herein are the property of the NHL and the respective teams and may not be reproduced without the prior written consent of NHL Enterprises, L.P. The Home Ice © channel is a registered trademark of XM Satellite Radio Inc. The Swinger Golfer logo is a registered trademark of PGA TOUR, Inc. Visit www.siriusxm.com/channellineup for updates. All programming/channel lineup/XM service subject to change or preemption. All other marks and logos are the property of their respective owners. All rights reserved.

IMPORTANT NOTICE: REQUIRED SUBSCRIPTION

Hardware and subscription sold separately, and activation fee required. Other fees and taxes may apply. **Subscriptions governed by SiriusXM Customer Agreement; see www.siriusxm.com.** Prices and programming are subject to change. **Service automatically renews into the subscription Package you choose (which may differ from the Package which arrived with the Radio), for additional periods of the same length, and automatically bills at the then current rates, after any complimentary trial or promotional period ends, until you call us at 1-866-635-2349 to cancel.** XM U.S. Satellite service available only to those at least 18 years of age in the 48 contiguous USA and DC, while SiriusXM Internet Radio is available throughout our satellite area and also AK, HI and PR.

Owners Record

The model number is located below and the Sirius ID is located on the label on the back of Stratus 7.

Record the Sirius ID in the space provided below. Refer to these numbers whenever you call your dealer regarding this product.

Model Number: SSV7

Sirius ID: _____

Sirius XM Radio Inc.
1221 Avenue of the Americas
New York, NY 10020

1.866.635.2349

siriusxm.com

© 2013 Sirius XM Radio Inc.

SSV7VKUG 130509a