

Introduction and Features

The SRK-JW18EH is a complete radio replacement kit with integrated climate control retention for select Jeep Wrangler JL and Jeep Gladiator JT vehicles. All modules and cables are included to retain important features of the factory system, including: steering wheel-mounted radio controls, factory reverse camera, USB ports, and AM/FM reception.

Data integration with the vehicle and the Stinger ELEV8 or Stinger HEIGH10® radio (sold separately) allows for the retention and addition of the following features: vehicle performance gauges and information, climate controls, vehicle settings, factory amplifier control, and forced camera activation. Simplified installation and setup menus allow direct programming of camera triggers, steering wheel controls, and other settings of the radio and CH4A-JW18 interface. See Important Notes (next section) for additional information.

Plug & Play wiring harnesses and cables allow for quick and easy installation without the need to cut or splice any wiring.

Important Notes

We recommend reading this manual thoroughly to familiarize yourself with the entire process prior to beginning the installation.

1. Does Not Retain:

Cluster Display Features

- Compass (when equipped with 7" or 8.4" screen)
- Clock
- Phone pop-ups
- Navigation pop-ups

Factory Amplifier Features

- Speed Controlled Volume

Uconnect Features

- Uconnect Access Remote Start / Lock / Unlock
- SOS / Assist
- Vehicle Location Service
- WiFi-Hotspot

SiriusXM Guardian Services

- SiriusXM Radio

2. When connected properly, the USB port inside the center console will function for **Apple Carplay/Android Auto**, and all other USB ports will be used for USB thumb drives and charging only.
3. Ensure that the CH4A-JW18, PL1, and RPA-HD1 modules have been updated to the latest version of firmware before installing into the vehicle. Refer to the Updating Firmware section at the end of the manual for firmware update instructions.
4. When connecting an HDMI streaming device to the RPA-HD1, use an HDMI extension cable to position it away from the module to ensure proper functionality. We recommend placing the HDMI device in the glove box. Failure to follow the directions may result in module malfunction.

Tools Needed; Included Components

Tools needed for installation: 7mm socket, 10mm socket, ratchet, ratchet extension, T20 torx screwdriver, T25 torx screwdriver, pick tool or small flathead screwdriver, plastic panel removal tool (example - PAC part number TL-PRY2).

1. **ELEV8 / HEIGH10 Display Mounting Panel**
2. **18" Data Harness (10P-2-10P-18)**
3. **CAN-Bus Connection Harness (MQS4PT-36)**
4. **Radio Module Mounting Brackets**
5. **Chime Speaker Mounting Accessories**
6. **Screen Panel Clips and Mounting Bracket Screws**
7. **External Chime Speaker**
8. **7' USB Port Retention Adapter (USB-UN2)**
9. **AM / FM Antenna Adapter (BAA22)**
10. **8" USB Hub Retention Adapter (USB-UN1)**
11. **6" Data Harness (10P-2-10P-6)**
12. **PAC-LINK Interface Module (PL1)**
13. **HD Camera Retention Module (RPA-HD1)**
14. **Radio Replacement Interface Module (CH4A-JW18)**
15. **Satellite Antenna Adapter (SAT-01)**
16. **12" HDMI Cable**
17. **Main Wiring Harness (RPK-JW18-HAR)**



SRK-JW18EH

Stinger ELEV8 or HEIGH10® Radio Replacement Kit for Jeep Wrangler JL and Jeep Gladiator JT Vehicles

Complete Wiring Diagram Overview

*Connections shown are all required for full functionality of the kit and radio. If adding additional components, additional connections will be needed.

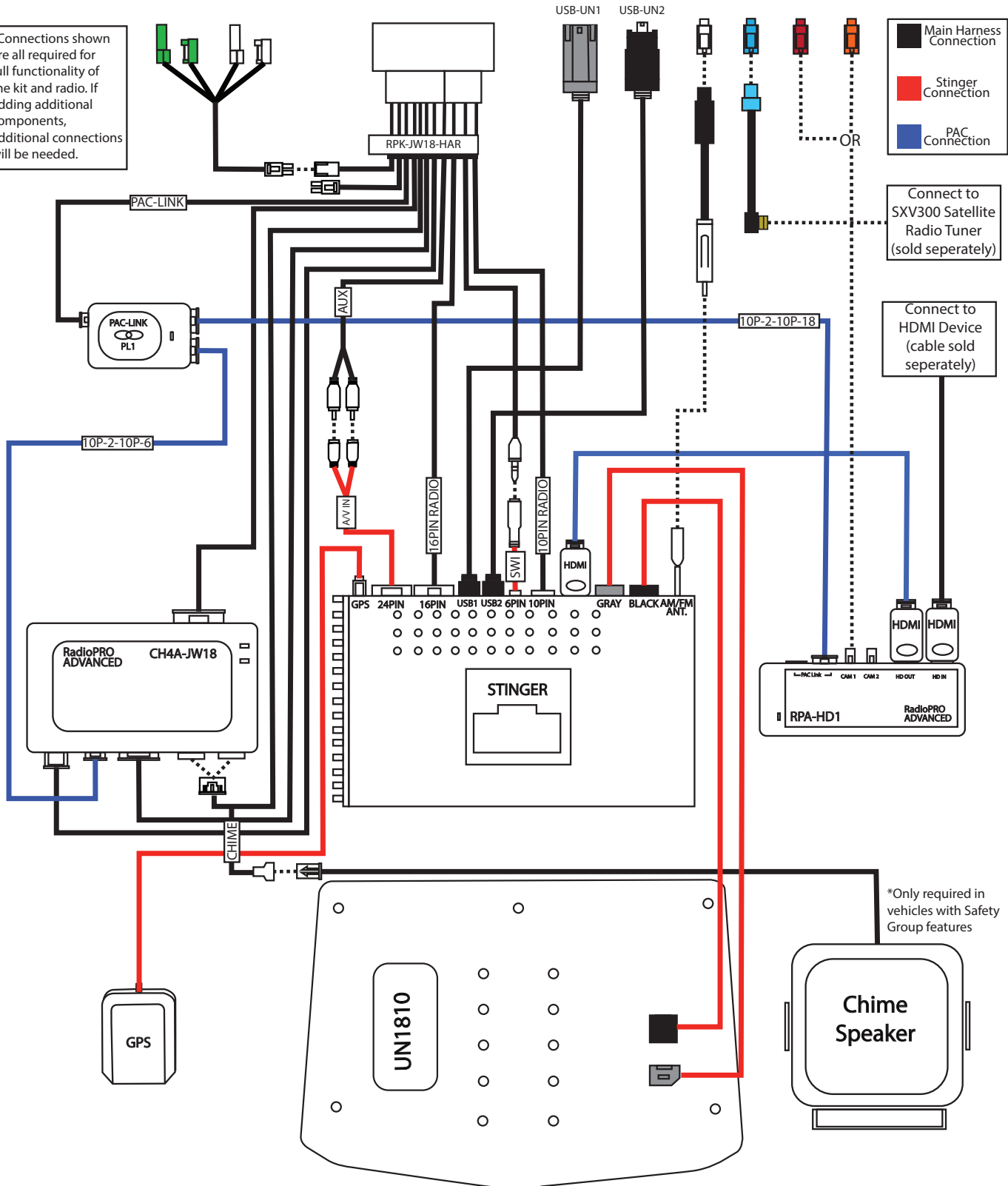

© 2020 AAMP Global. All rights reserved. PAC is a Power Brand of AAMP Global.

AAMP Global is not affiliated with FCA US LLC. Jeep® is a registered trademark of FCA US LLC. The terms OEM, Jeep®, Wrangler®, and Gladiator® all terms are used strictly for identification purposes only. It is not implied that any part listed is a product of, or approved by, Fiat Chrysler Automobiles.

Rev: v3
Date: 100620

This installation manual will cover the necessary order of procedures to complete the installation efficiently and to avoid redoing any steps along the way. The order will be as follows; Disassembly, Radio Unit Mounting Preparation, Radio Unit Harness Connections and Preparation, In-Vehicle Harness Connections and Preparation, Radio Unit Installation, and Reassembly.

Section 1: Disassembly

Part One: Radio Removal

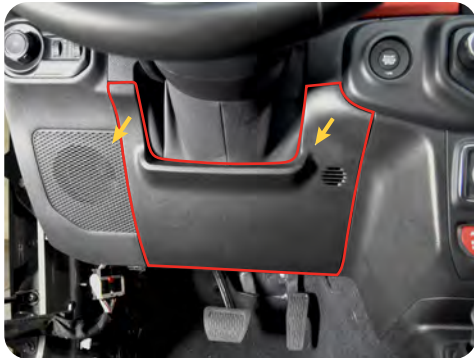

Step 1

Pull out at the top of the knee bolster to release the retaining clips, then work your hands down the edges of the knee bolster to release the remaining clips and remove the panel.



Step 2

Grasp the climate control panel at the exposed left edge and pull out to unclip the left side, then work your fingers around the remaining edges of the panel to fully unclip it.



Step 3

Disconnect the push-to-start button and climate control connectors from the back of the climate control panel and remove.



Step 4

Remove the two 7mm screws securing the radio bezel to the dash, then pull outward on the radio bezel to unclip it and remove.



Step 5

Remove the four 7mm screws securing the radio in place, then lift the radio out of the radio cavity.



Step 6

Disconnect the antenna and USB connectors from the back of the radio, then disconnect the 52-pin dock-and-lock connector and remove the radio.

Section 1: Disassembly (cont.)

Part Two: Glove Box Removal

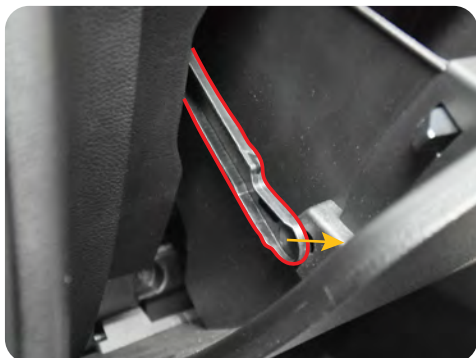

Step 1

Open the glove box and unclip the soft-open sliding arm clasp from the left side of the glove box.

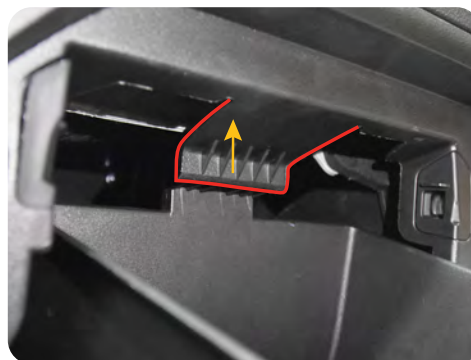

Step 2

Push up on the glove box stop tab to allow the glove box to fall forward out of the glove box opening, then unhinge the bottom of the glove box and remove.

Part Three: Center Console Panel Removal



Step 1

Open the center console storage lid, then remove the two T20 torx screws securing the rear console panel in place.



Step 2

While pulling the panel towards the rear of the vehicle, use a plastic panel removal tool to release the clips securing the panel in place and remove.



Step 3

Disconnect the inner center console USB port connector.

Section 1: Disassembly (Cont.)

Part Four: Door Sill Trim Removal

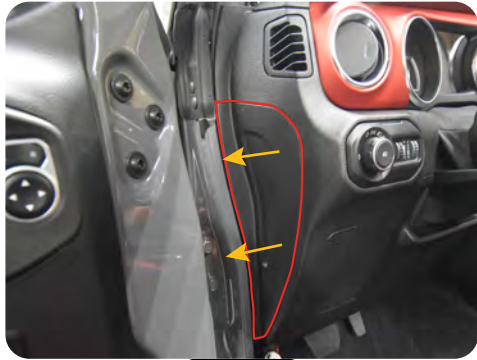

Step 1

Use a plastic panel removal tool to remove the panel on the driver side of the dash.



Step 2

Use a plastic panel removal tool to open the driver side handle bolt covers, then remove the two 10mm bolts.



Step 3

Remove the two T25 screws on the underside of the driver side upper door seal trim.

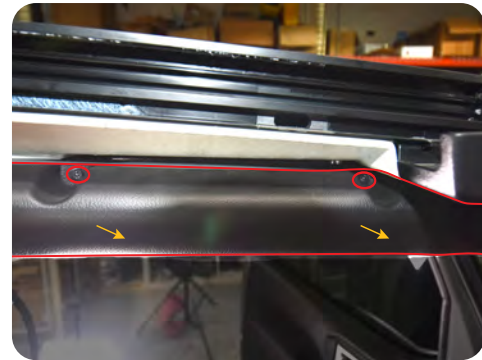

Step 4

Remove the two T25 screws on the inner-most side of the driver side upper door seal trim; then, while pulling towards the middle of the vehicle, use a plastic panel removal tool to remove it.

Section 2: Radio Unit Mounting Preparation

Part One: Assembling the Radio Module Mounting Brackets

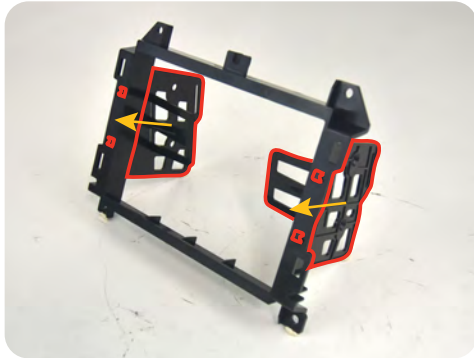

Step 1

Slide the left and right side brackets (marked by the letters LH and RH) into the back of the main bracket (the orientation of the main bracket is marked by the part number at the top).

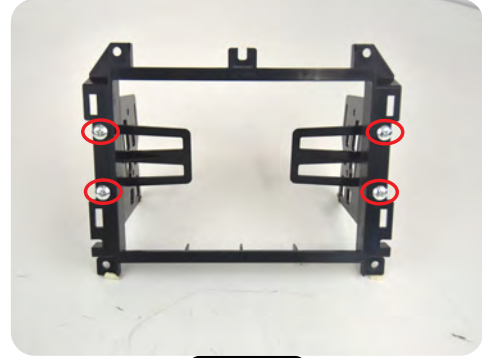

Step 2

Secure the side brackets to the main bracket using the four #10x3/8 Phillips coarse threaded screws.

Part Two: Mounting the Interface Modules and Stinger Radio Module

Note: It does not matter what the DIP switches on the CH4A-JW18 module are set to.



Step 1

Mount the CH4A-JW18 module to the left and right inner mounting tabs of the radio module mounting brackets using zip ties. Ensure the module is oriented with the part number (CH4A-JW18) on the right side.

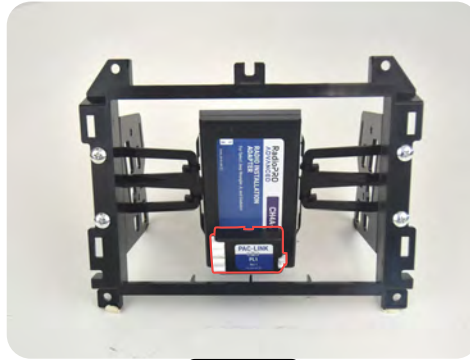

Step 2

Mount the PAC-LINK module to the lower part of the CH4A-JW18 module using a piece of the provided double-sided tape.



Step 3

Mount the Stinger radio module onto the side brackets using the four M5x10 Phillips screws (only two shown). Ensure that the ports for connections on the radio module are facing down.

Section 2: Radio Unit Mounting Preparation (cont.)

Part Three: Assembling the Screen Mounting Panel



Step 1

Install the six orange retaining clips onto either the ELEV8 or the HEIGH10 mounting panel (HEIGH10 panel shown).



Step 2

Lay the radio screen into the mounting panel and secure it to the panel using the four M4x12 screws included in your ELEV8 or HEIGH10 box.

Section 3: Radio Unit Harness Connections and Preparation

Part One: Main Harness Connections (RPK-JW18-HAR)



Step 1

Connect the two Stinger radio module connectors which are labeled "16PIN RADIO" and "10PIN RADIO" into the appropriate ports on the Stinger radio module.

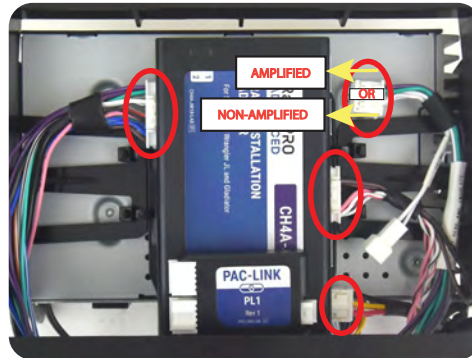

Step 2

Connect the four CH4A-JW18 interface module connectors into the appropriate ports on the CH4A-JW18 interface module. Ensure that the 12-pin connector is plugged into the correct audio output port (this depends on if the vehicle is equipped with a factory amplifier or not).



Step 3

Connect the PL1 interface module connector labeled "PAC LINK" into the 3-pin port on the PAC-LINK interface module.

Section 3: Radio Unit Harness Connections and Preparation (cont.)

Part One: Main Harness Connections (RPK-JW18-HAR) (cont.)



Step 4

Connect the 24-pin A/V Stinger RCA harness (provided in the Stinger radio box) into the 24-pin port on the Stinger radio module.

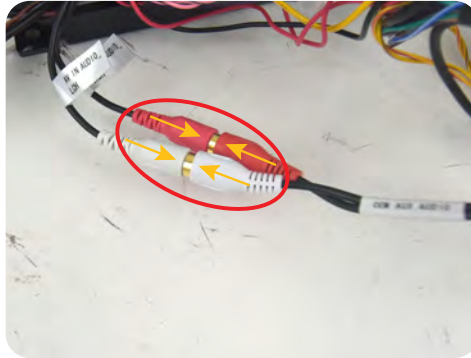

Step 5

Connect the white and red male RCAs labeled "OEM AUX AUDIO" on the RPK-JW18-HAR into the white and red female RCAs labeled "LINE IN / AUX IN" on the A/V Stinger RCA harness.



Step 6

Connect the 6-pin SWI / IR harness (provided in the Stinger radio box) into the 6-pin port on the Stinger radio module, then connect the 3.5mm jack labeled "STEERING WHEEL CONTROL" on the RPK-JW18-HAR into the female 3.5mm connector labeled "SWI" on the Stinger SWI / IR harness.

Part Two: 10P-2-10P Harness and HDMI Connections

Prior to making connections to the RPA-HD1 module, verify that all 4 of the module's DIP Switches are set to the up position (OFF).

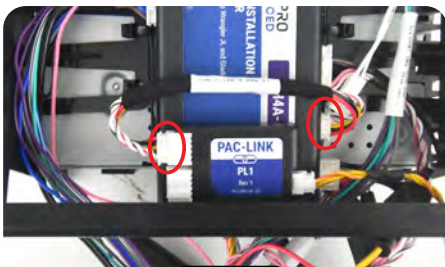
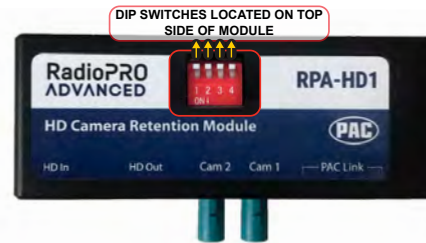

Step 1

Connect one end of the 6" harness (10P-2-10P-6) into the 10-pin expansion port on the CH4A-JW18 interface module, then connect the other end into either of the two 10-pin ports on the PL1 interface module.



Step 2

Connect one end of the 18" harness (10P-2-10P-18) into either of the two 10-pin PAC Link ports on the RPA-HD1 interface module. The other end will be connected to the open 10-pin port on the PL1 interface module after mounting the radio unit into the vehicle.



Step 3

Connect one end of the 12" HDMI cable into the HD OUT port on the HD1 interface module. The other end will be connected to the HDMI input port on the Stinger radio module after mounting the HD1 interface module into the vehicle.

Section 3: Radio Unit Harness Connections and Preparation (cont.)

Part Three: Stinger Display Connections



Step 1

Connect one end of the 8-pin display power harness into the 8-pin port on the Stinger radio module, then connect the LVDS display video cable into the LVDS display port on the Stinger radio module. (Both of these cables are provided in the Stinger radio box.)



Step 2

Route the display harness and cable through the front opening of the main radio module mounting bracket.

Part Four: Securing the Wire Harness



Step 1

Run a zip tie through the metal eyelet on the connections side of the Stinger radio module, then tighten it down around the main wiring harness to secure it in place tightly against the radio module.

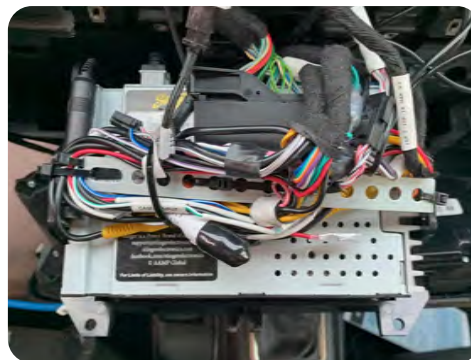

Step 2

Secure each end of one backstrap (included in the Stinger radio box) to the plastic eyelets on the side radio module mounting brackets, then use zipties to secure the factory style 52-pin connector and the rest of the radio unit wiring to the back strap. (The unit should resemble the image pictured when complete.)

Section 4: In-Vehicle Harness Connections and Preparation

Part One: CAN Connections Harness (MQS4PT-36)

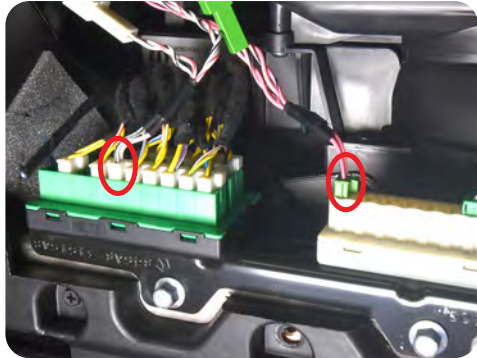

Step 1A

Behind the glovebox, connect the male white connector from the MQS4PT-36 harness into the green CAN junction block and the male green connector from the MQS4PT-36 harness into the white CAN junction block, then run the 4-pin connector on the MQS4PT-36 harness behind the dash to the radio opening.

OR



Step 1B

If there are no open ports on the CAN junction blocks, unplug one factory male connector and insert it into the same colored female connector on the MQS4PT-36 harness, then insert the male connector on the MQS4PT-36 harness into the now empty port on the CAN junction block.

Part Two: GPS Antenna and External Microphone (provided in Stinger radio box)



Step 1

Clean the area next to the factory antenna on the center roll cage structure and stick the GPS mounting plate to it. Then, secure the GPS antenna to the mounting plate (it is magnetic). Route the cable behind the trim panels of the roll cage over to the driver side A-pillar.



Step 2

Route the GPS cable down the A-pillar past the plastic dash side panel, then route the cable behind the lower dash below the steering column and then up the center stack to the radio opening. (Secure with zip ties along the way.)



Step 3

If you choose to use the external microphone instead of the internal microphone, mount it to the upper windshield trim panel above the rear-view mirror, then route the cable underneath the trim panels across the upper windshield and follow the route of the GPS cable to the radio opening.

Section 4: In-Vehicle Harness Connections and Preparation (cont.)

Part Three: Chime Speaker



Step 1

Remove the knobs from the chime speaker and mount the chime speaker bracket to the metal brace underneath the steering column using the double sided tape, mounting bolts, and wing nuts. Then, reinstall the speaker to the mounting bracket. (Two holes must be drilled into the metal brace to secure the speaker mounting bracket to it.)

Note: Installation of the chime speaker is only required in vehicles with safety group features.



Step 2

Route the chime speaker cable behind the dash panels to the radio opening.

Part Four: USB Retention Adapters



Step 1

Connect the USB-UN1 adapter to the factory USB connector that was unplugged from the factory radio.



Step 2

Connect the USB-UN2 adapter to the factory USB port in the back of the center console, then route the cable along the passenger side of the center console to the radio opening.

Section 4: In-Vehicle Harness Connections and Preparation (cont.)

Part Five: AM / FM Antenna Adapter and RPA-HD1

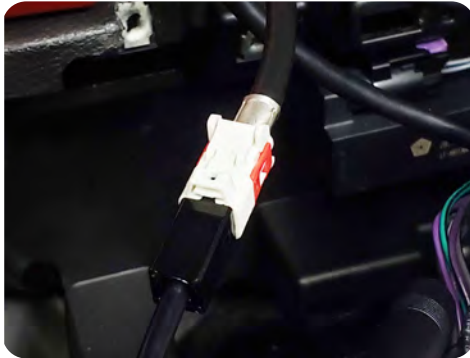

Step 1

Connect the AM/FM antenna adapter (BAA22) to the antenna with the white connector that was disconnected from the factory radio.

Note: You can also place the RPA-HD1 into the cavity that is below the radio cavity behind the climate control panel on the right side.



Step 2

Connect the factory camera cable with an orange or red Fakra connector into the Cam 1 port on RPA-HD1, then slide the RPA-HD1 through the radio opening into the cavity behind the dash that is above the center left air vent or into the cavity behind the right side of the climate control mounting area.

Section 5: Radio Unit Installation

Part One: Harness and Cabling Connections



Step 1

Before attempting to mount the radio unit into the dash, first ensure that all excess cables and wires are tucked into the sides, out of the way of the radio. The radio unit is a snug fit and will be difficult to mount into the dash if there is anything taking up space behind the radio opening.

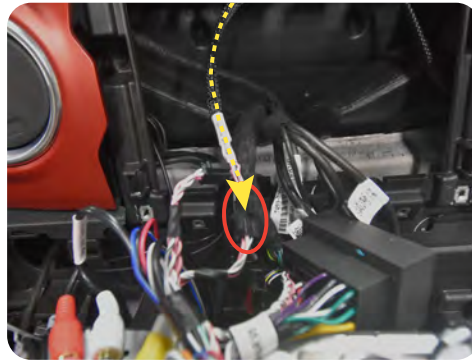

Step 2

Disconnect the two 4-pin connectors on the RPK-JW18-HAR, then connect the MALE 4-pin connector on the MQS4PT-36 harness into the FEMALE 4-pin connector on the RPK-JW18-HAR. The MALE 4-pin connector on the RPK-JW18-HAR will no longer be used.

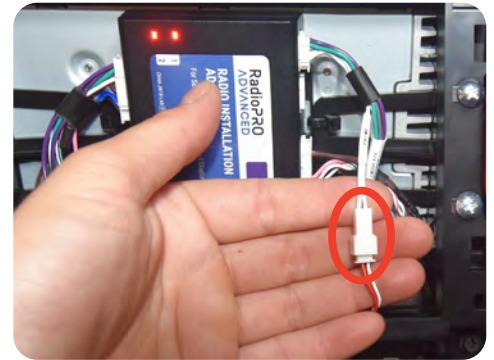

Step 3

Connect the 2-pin chime speaker connector to the main harness.

Section 5: Radio Unit Installation (cont.)

Part One: Harness and Cabling Connections (cont.)

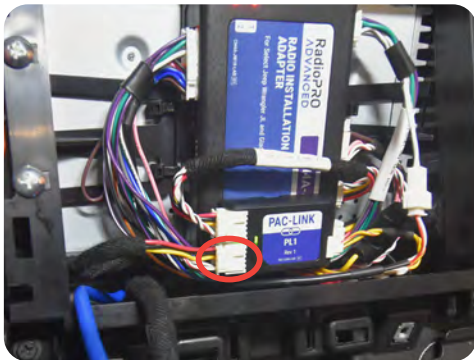

Step 4

Connect the 10P-2-10P-18 connector coming from the RPA-HD1 interface module into the open port on the PL1 interface module, then connect the 52-pin dock-and-lock connector to the main OEM radio connector in the vehicle.

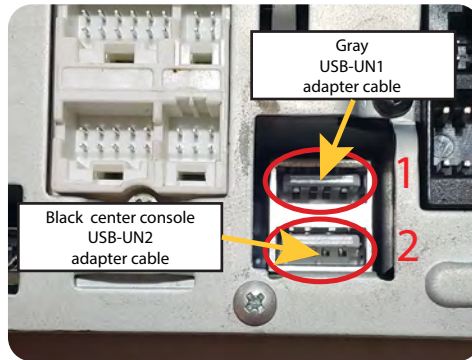

Step 5

Connect the USBs into the appropriate ports on the Stinger radio module. Ensure that the USB-UN1 is connected to port 1, and the center console USB-UN2 is connected to port 2.

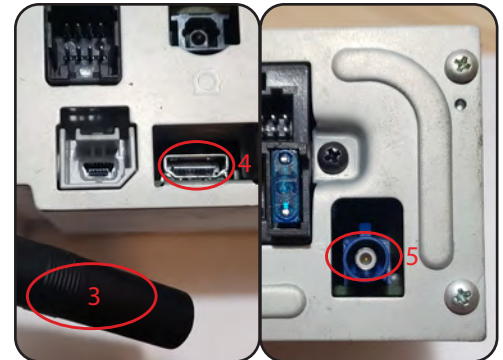

Step 6

Connect the AM/FM antenna (3), the HDMI cable (4), and the GPS antenna (5).

For a complete wiring diagram overview, refer to page 2.

Part Two: Radio Unit Mounting

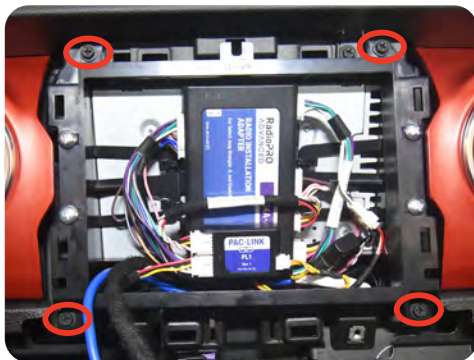

Step 1

While holding the cabling above the vents in the dash, slide the radio unit into the radio cavity and secure it to the dash using the four 7mm screws that held the factory radio in place.

Note: Once the radio unit is slid into the radio cavity, the kit will not always seat fully into the dash. There is sometimes about a 1/4-inch gap between the screw holes. If the previous steps of the instructions were followed, this 1/4-inch gap will close with the tightening of the four 7mm screws, allowing the kit to seat fully into place. If there is more than a 1/4-inch gap before installing the screws, slide the radio unit back out and readjust the connectors and cables behind the radio opening until they are no longer in the way of the radio unit, then reinstall.



Step 2

Connect the Stinger display cables into the back of the Stinger radio display and secure it to the radio unit mounting bracket against the dash using the orange clips and the two 7mm screws below the radio cavity.

Troubleshooting

- Reverse camera inoperable** - Verify that all reverse camera wiring connection points are proper by reviewing the RPA-HD1 connection steps.
- Vehicle Info icon not showing on main menu** - After updating the Radio System Firmware, perform a master reset on the radio by tapping "Master Reset" in the "Installer Settings"; then, update the PAC Application APK firmware in that order. If the Vehicle Info icon still does not show, turn off the vehicle, open the driver door, and let it sleep for about 20 seconds, then restart the vehicle and check for the Vehicle Info icon again.

CH4A-JW18 Interface Module LED Diagnostics

LED Pattern	State	Action
LED 2 solid red	Vehicle RAP / ACC Output Is On	N / A
LED 2 flashing green	SWC Activity	N / A
LED 2 flashing red	Module Resetting / Initializing	N / A
LED 1 solid green	Module Powered and Operating	N / A
LED 1 flashing amber	USB Connected	N / A
Off	No Activity	Verify key is in ignition position. Verify that there is 12v on the yellow wire and ground on the black wire.

RPA-HD1 Camera Module LED Diagnostics

LED Pattern	State	Action
LED solid red	Initial Power-Up	N / A
LED flickering green	Querying RadioPro for Configuration	N / A
LED flashing green	Normal Operation w/ HDMI Pass-thru	N / A
LED solid amber	Normal Operation w/ Camera selected	N / A
Off	No Activity	Verify 10pin harness connections and key position

PL1 Adapter Module LED Diagnostics

LED Pattern	State	Action
LED flickering green or red	Data Communication / Normal Operation	N / A
Off	No Activity	Verify 10pin harness connections and key position

Product Updates (Firmware)

Firmware Updates (RadioPRO, PL1, HD1 Interface Modules)

The RadioPRO PC app will allow you to update the interface modules with new firmware as it becomes available. Please visit www.PAC-audio.com/firmware to download available updates.

To update an interface module, open the RadioPRO PC app, connect the interface to your PC via a micro USB cable, and select "Firmware" and then "Update Firmware".

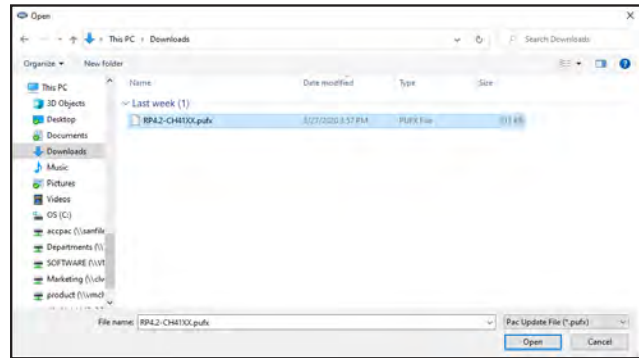

Now, select "Select File". Finally, browse to the place where you saved the file, and select it. This will begin the updating process. Once finished, disconnect the interface from the PC. Repeat for every module: CH4A, PL1, HD1, and test operation.

Firmware Updates (Stinger Radio and PAC Application APK)

To update the Stinger radio firmware and PAC Application APK firmware, refer to the Installer Setup Manual for an in-depth walk-through on how to perform these updates on your Stinger radio unit.

Reset / Restoring Interface Factory Settings

You can restore the RadioPRO interface module to factory default settings by pressing and holding the programming button on the side of the module until the status LED starts blinking red. Once the LED starts blinking red, release the button. You must release the button while the LED is blinking red in order to perform the reset. This reset will restore all settings to factory defaults.

Technical Support

Email: support@PAC-audio.com
Phone: 727-592-5991
International: 866-931-8021

