



SRK-CHR15H

INTEGRATION & INSTALLATION KIT

Installation Guide

2015-2021 Dodge Charger



DESIGNED FOR:
HEIGHT10[®]
Stinger Infotainment Products

Check [PAC-Audio.com](https://catalog.pac-audio.com) for Installation Video:
<https://catalog.pac-audio.com/catalog/radio-replacement/srk-chr15h>



Introduction and Features

The SRK-CHR15H is a complete radio replacement kit for the installation of the Stinger HEIGH10® modular radio in Chrysler 300, Dodge Charger or Dodge Charger equipped with either 5" or 8.4" factory display radios. All modules, cables and adapters are included to retain important features of the factory system, including: steering wheel-mounted radio controls, factory amplifier, factory reverse camera, USB port and AM/FM reception. Plug & Play wiring harnesses allow for quick and easy installation without the need to cut or splice any wiring. The display mounting panel allows mounting the 10-inch display without modifying/cutting any part of the vehicle's sub-dash.

Important Notes

We recommend reading this manual thoroughly to familiarize yourself with the entire process prior to beginning the installation.

1. Does Not Retain:

Cluster Display Features

- Compass (when equipped with 5" or 8.4" screen)
- Clock
- Phone pop-ups
- Navigation pop-ups
- Launch Control Timers

Factory Amplifier Features

- Speed Controlled Volume
- Surround Sound

SiriusXM Guardian Services

- SiriusXM Radio

Uconnect Features

- Uconnect Access Remote Start / Lock / Unlock
- SOS / Assist
- Vehicle Location Service
- WiFi-Hotspot

Performance Features

- Launch Control with Launch RPM
- Line Lock
- G-Force status on radio (still on instrument cluster)

2. Not compatible with SRT or Hellcat trim levels.
3. Not compatible with 2015 model year vehicles equipped with drive modes.
4. Ensure that the CH4A-SRK and PL1 modules have been updated to the latest version of firmware before installing into the vehicle. Refer to the Updating Firmware section at the end of the manual for firmware update instructions.
5. The vehicle should be OFF and key removed during entire disassembly and installation. Turning on the vehicle during the installation may cause error codes / check engine light.

Included Components

1. Mounting Bucket 1 (CDJ13H-1)
2. Mounting Bucket 2 (CDJ13H-2)
3. Display Mounting Frame (CDJ13H)
4. CAN-Bus Connection Harness (MQS4PT36V2)
5. Mounting Hardware:
 - 4 - #8 X 1/2" PHP POINT TIP SCREWS
 - 4 - #8 X 3/4" PHP POINT TIP SCREWS
 - 1 - M4 X 8, FHP, BLACK DISPLAY SET SCREW
6. 6" Data Harness (10P-2-10P-6-HAR)
7. Main Wiring Harness (SRK-CHR16-HAR)
8. Side Brackets (CDJ13H-LH/RH)
9. Spacers (CDJ13H_Bracket Spacer) x2
10. Satellite Antenna Adapter (SAT-01)
11. AM/FM Antenna Adapter (BAA22)
12. PAC-LINK Interface Module (PL1)
13. RadioPRO Interface Module (CH4A-SRK)
14. Chime Speaker & Hardware (RPA-SPK)
15. Media Hub (USBHUB-CH1B-RCA-48)
16. Zip Ties (Not shown)

NOTE: Along with the SRK-CHR15H components, additional hardware and wire harnesses from the HEIGH10 (UN1810) kit will also be used in the installation.



SRK-CHR15H

Stinger HEIGH10® Radio Replacement Kit

Installation Guide

2015-2021 Dodge Charger

Wiring Diagram Overview

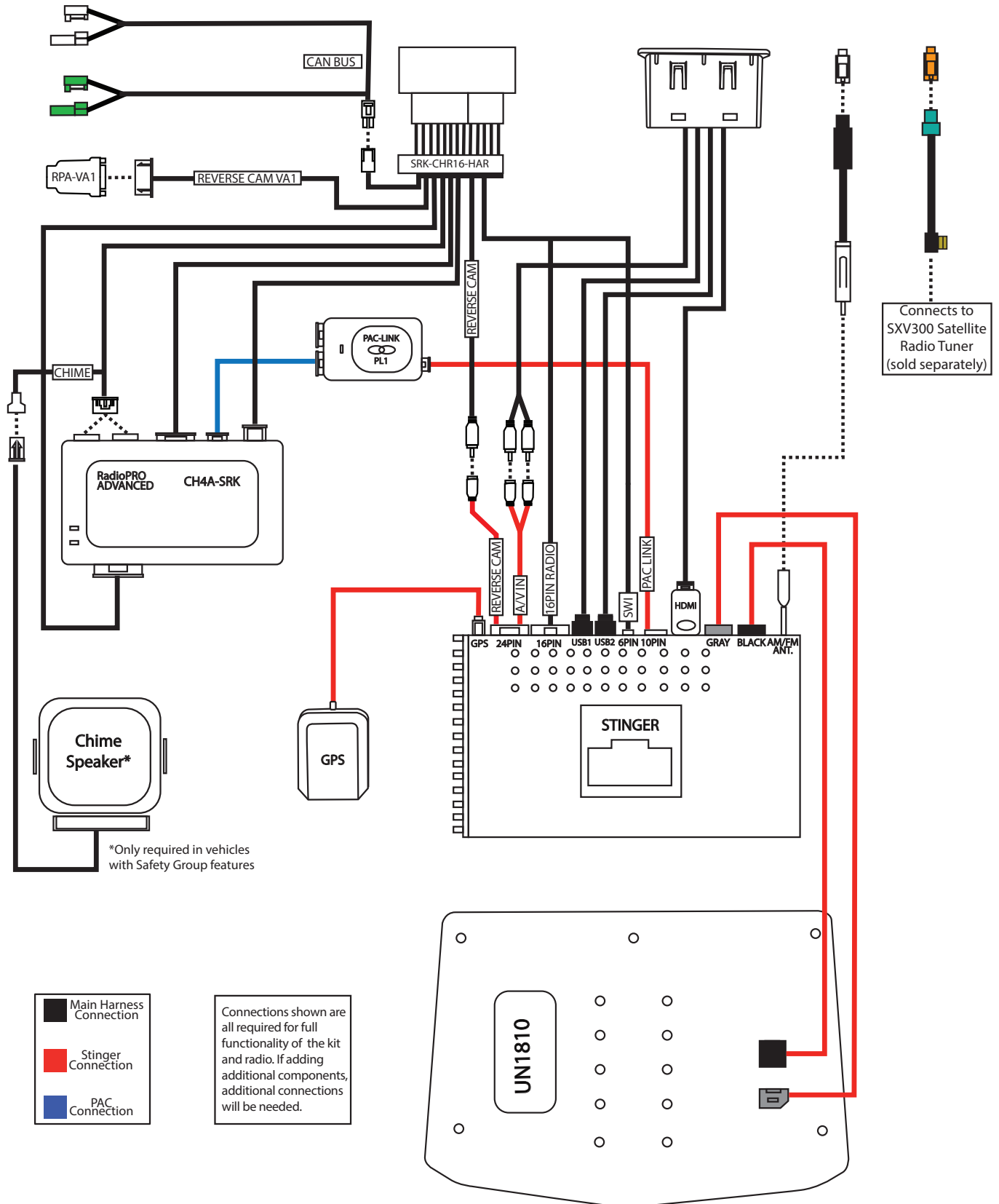

Section 1: Dodge Charger Disassembly

Part One: Radio Removal



Step 1

Using a plastic trim tool, release all the retaining clips holding the trim panel around the instrument cluster and radio display.

NOTE: If this dash panel has not been removed before, it may require extra force to remove.



Step 2

Lower the steering column and remove the panel by pulling outward far enough that the air vents are clear of the sub-dash.

NOTE: During removal, air vents may detach from the panel; they can be reattached to the back of the panel.

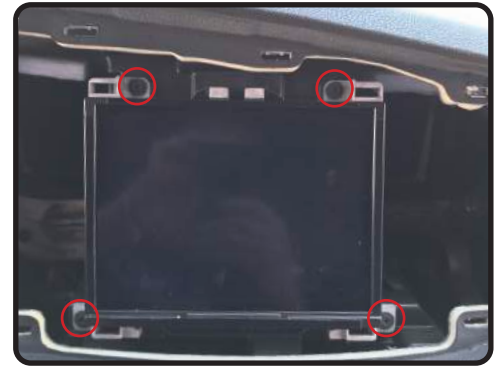

Step 3

Remove the four screws securing the factory radio display and pull radio out to access the connectors on the back.



Step 4

Disconnect all cables and connectors from the back of the radio and remove the radio.

Section 1: Dodge Charger Disassembly (cont.)

Part Two: Access Driver and Passenger CAN Junction Blocks (STAR Connectors)



Step 1

Using a trim tool, remove the drivers side dash end panel.



Step 2

Remove the two Phillips screws securing the side of the lower dash knee panel.



Step 3

Pull the lower knee panel outward to release the retaining clips along the top allowing access to the CAN junction block attached to the backside of the panel.



Step 4

The passenger side CAN junction block is located below the glove box.



Step 5

Remove the three push fasteners holding the fabric closeout panel below the glove box. Temporarily let it lay on the floor board.



Step 6

Looking up under the glove box, locate the green CAN junction block with white plugs.

Section 1: Dodge Charger Disassembly (cont.)

Part Three: Center Console Removal for Media Hub Installation



Step 1

Using a plastic trim tool, unclip the shifter boot trim panel.



Step 2

Unplug the connector on the backside of the panel and lift panel up to expose the shift lever lock screw.



Step 3

Remove the shift lever lock screw and pull up to remove the shift lever and shifter boot assembly. (Manual shifter will have two bolts at the base of the shift lever.)



Step 4

Remove the two screws below the lower storage bin.

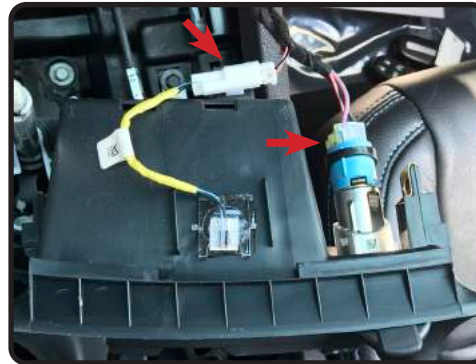

Step 5

Pull the lower storage bin outwards to release the retaining clips. Unplug the connectors and remove the storage bin.

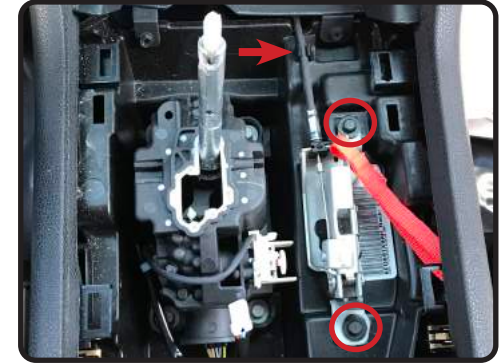

Step 6

Remove the two bolts and unclip the cable and position the manual park release aside.

Section 1: Dodge Charger Disassembly (cont.)

Part Three: Center Console Removal (cont.)

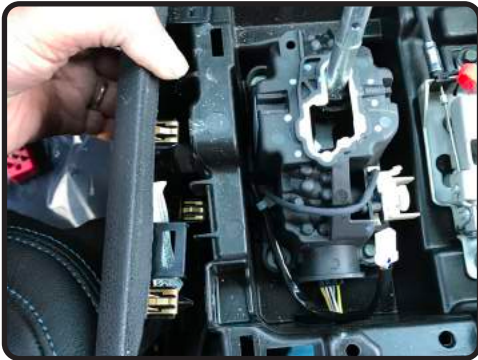

Step 1

Unclip and remove the side panels on both sides of the console.



Step 2

Unplug the factory USB connector on the right side of the console.



Step 3

Remove the two screws at the front of the console.



Step 1

Open the console storage compartment and remove the coin tray and bottom rubber liner.



Step 2

Remove the four screws inside the storage compartment that secure the console to the floor.



Step 3

Slide the floor console slightly rearward and tilt up. Disconnect the wire harness connectors and remove the console.

Section 2: Dodge Charger Media Hub Installation



Step 1

Compress the four retaining tabs on the hub to release the assembly from the console. Disconnect the connectors from the back of the factory USB hub and remove.



Step 2

Referencing the front cover, install the four cable ends into the back section of the USBHUB-CH1B-RCA-48 replacement hub. Align and snap both sections together.



Step 3

Feed the other end of the four media cables through the opening on the inside of the console storage area.

NOTE: Only one of the two USB ports will allow Apple CarPlay and Android Auto operation. If there is a preference on which USB port will be used, mark that USB cable so it can be identified when connecting to the radio module.



Step 4

Once all the slack is pulled through, align and snap the replacement hub into place.



Step 5

Flip the console over on a soft surface. Bundle and route the cables towards the front the console.



Step 6

Secure cables to the factory wire harness that is running along the bottom of the console. Secure with zip ties.

Section 3: Dodge Charger In-Vehicle Harness Connections and Preparation

Part One: Routing Media Hub Cables



Step 1

Temporarily position the console back in the vehicle.
(The console will be fully reassembled and secured after radio installation is finished and tested).



Step 2

Route the four media cables up from the lower dash into the radio opening area.

Part Two: Driver and Passenger Side CAN Connections (MQS4PT36V2 Harness)



Step 1

Starting at the radio opening, route the twisted pink wires with green connectors on the MQS4PT36V2 harness to the drivers side CAN junction block.



Step 2

On the drivers side, plug the green male plug on the MQS4PT36V2 harness into one of the open ports on the CAN junction block. The female plug will not be used.
If there are no open ports, see note on next page.



Step 3

Route the twisted white striped wires with white connectors on the MQS4PT36V2 harness from the radio opening to the passenger side CAN junction block.

Section 3: Dodge Charger In-Vehicle Harness Connections and Preparation (cont.)

Part Two: Driver and Passenger Side CAN Connections (MQS4PT36V2 Harness)



Step 4

On the passenger side, plug the white male plug on the MQS4PT36V2 harness into one of the open ports on the CAN junction block. The female plug will not be used

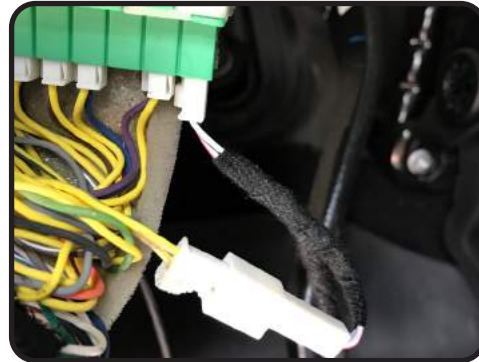

NOTE

If there are no open ports on either junction block, unplug one factory male connectors and insert it into the female connector on the MQS4PT36V2 harness, then insert the male connector on the MQS4PT36V2 harness into the now empty port on the CAN junction block.

Part Three: GPS Antenna and AM/FM Antenna Adapter (BAA22)



Step 1

From the HEIGH10 kit, locate the GPS antenna and metal mounting plate.



Step 2

Stick the metal plate to the top of the right side air vent. Excess cable can be secured and stowed in the space to the right of the vent.



Step 3

Connect the BAA22 antenna adapter from the SRK-CHR15H kit to the white antenna plug in the vehicle.

Section 3: Dodge Charger In-Vehicle Harness Connections and Preparation (cont.)

Part Four: Optional Chime Speaker Installation

Note: Installation of the chime speaker is only required in vehicles equipped with Safety Group (parking sensors).



Step 1

The chime speaker can be mounted in various locations. This installation uses a factory stud and bolt to the left of the steering column since that area is accessible.



Step 2

Remove the speaker from the mounting bracket. Enlarge the mounting hole to fit over the factory stud. Reinstall and tighten the bolt.



Step 3

Remount the speaker on the bracket. Feed the 2-pin speaker plug up to the radio opening. Securing wiring and excess cable with zip ties.

These are the basic connections for the radio. If installing additional components (external microphone, SXM tuner, amplifiers, etc) those should be installed now.

Section 4: Interface and Main Harness Connections



Step 1

Connect the three connectors from the SRK-CHR16-HAR Main Harness to the indicated ports on the CH4A-SRK module.



Step 2

Referencing the sticker on the back, connect the fourth connector to the appropriate port. *Amplified* if the vehicle has a factory amplifier, *Non-Amplified* for base audio.



Step 3

Connect one end of the 6" Data Harness (10P-2-10P-6-HAR) to the CH4A-SRK Expansion Port and the other end to either port on the PAC-LINK (PL-1)

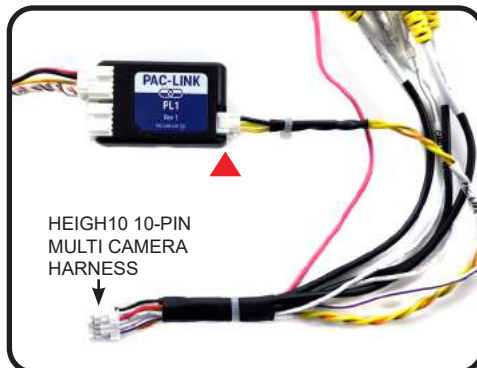

Step 4

From the HEIGH10 wire harnesses, connect the 3-pin PAC-Link lead on the 10-pin Multi Camera Harness to the PL-1.

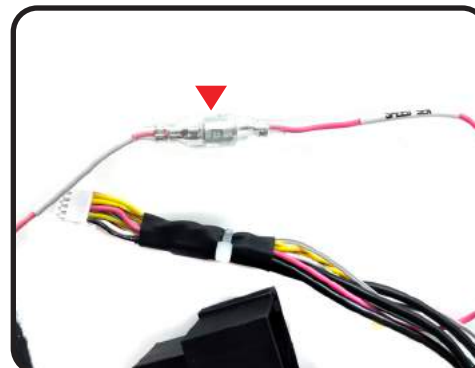

Step 5

Connect the pink SPEED SEN lead on the Main Harness to the pink SPEED SEN lead on the HEIGH10 10-pin Multi Camera Harness.

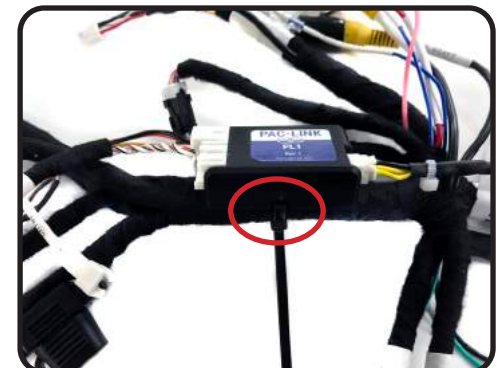

Step 6

Zip tie the PAC-Link (PL-1) to the main harness.

Step 7

Connect the male and female ends of the Light Green leads together. Connect the RPA-VA1 to the 6-pin REVERSE CAM VA1 plug.

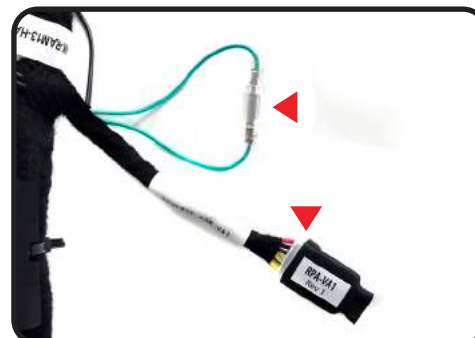

SRK-CHR15H

Stinger HEIGH10® Radio Replacement Kit

Installation Guide

2015-2021 Dodge Charger

Section 5: Dodge Charger Interface & Radio Module Mounting Preparation

Part One: Side Brackets and Spacers

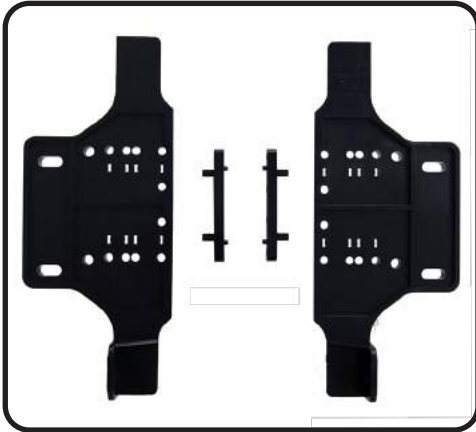

Step 1

From the SRK-CHR15H kit, locate the RH and LH side brackets and spacers.



Step 2

For Charger/Challenger, the spacers will be installed in **Position 3** on the side brackets as indicated above.



Step 3

Install the spacers on the inside of the side brackets in **Position 3** as shown.



Step 4

From the SRK-CHR15H kit, align and snap together mounting Bucket 1 and Bucket 2



Step 5

Secure both parts using four #8 x 1/2" Phillips screws provided in the SRK-CHR15H hardware kit.

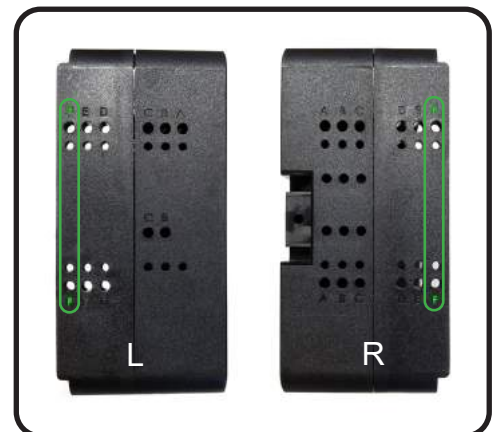

Step 6

For Charger/Challenger, the side brackets will be attached to the bucket assembly in **Position F** as indicated above.



Section 5: Dodge Charger Interface & Radio Module Mounting Preparation (cont.)

Part One: Side Brackets and Spacers (cont.)



Step 5

Align the locator pins on the left side bracket spacer to **Position F** on left side of the bucket. Attach using two #8 x 3/4" screws



Step 6

Align the locator pins on the right side bracket spacer to **Position F** on right side of the bucket. Attach using two #8 x 3/4" screws

Part Two: Interface and Radio Module Mounting



Step 1

With the mounting assembly face down, place the CH4A-SRK module as shown. Loosely install zip ties through the module mounting tabs and through the anchor locations.



Step 2

Install a zip tie to secure the wire harness on the right side. Tighten and trim all zip ties.

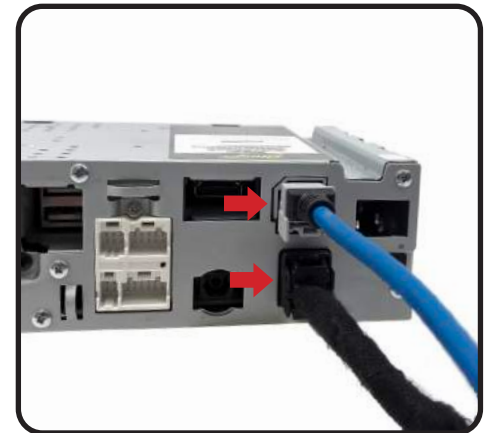

Step 3

From the HEIGH10 components, plug the 8-pin and LVDS USB display cables into the radio module.

NOTE: Before mounting the radio module, it is recommended to plug a micro USB cable into the CH4-SRK interface. The cable should be routed to a location in the vehicle that is accessible without disassembling the vehicle and removing the radio if firmware updates are needed in the future.

Section 5.1: Dodge Charger Interface & Radio Module Mounting Preparation (cont.)

Part Two: Interface and Radio Module Mounting (cont.)

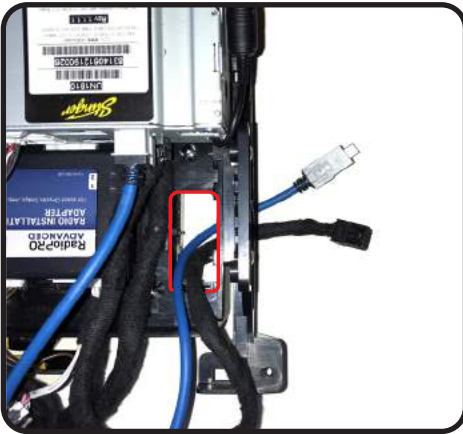

Step 5

Route the other end of the display cables through the opening in the mounting assembly. Leave approximately two inches of cable extending out the front.

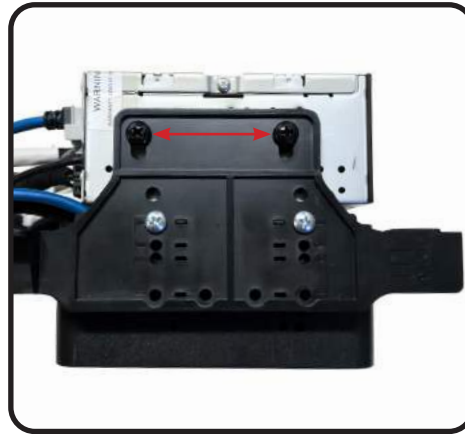

Step 6

Position the radio module between the side brackets and align the left side mounting holes as shown. Secure the radio module to the side bracket using two M5x10 screws from the HEIGH10 hardware.

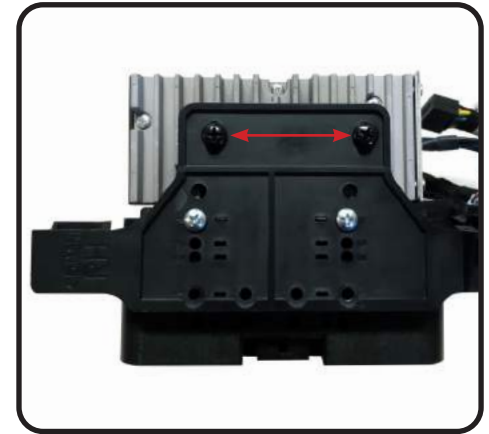

Step 6

Align the right side mounting holes as shown. Secure the radio module to the side bracket using two M5x10 screws from the HEIGH10 hardware.

Part Three: Radio Module Harness Connections

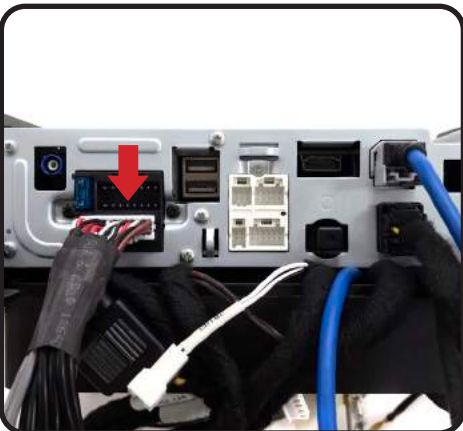

Step 1

From the HEIGH10 components, plug the 24-pin AV harness into the radio module.

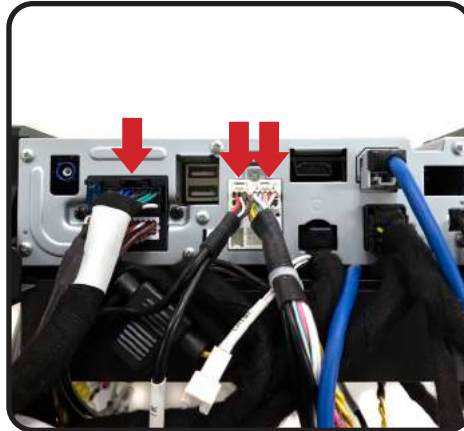

Step 2

From the SRK-CHR16-HAR, plug in the HEIGH10 16-pin Main Radio harness, 6-pin SWC/IR harness and the 10-pin Multi Camera harness.

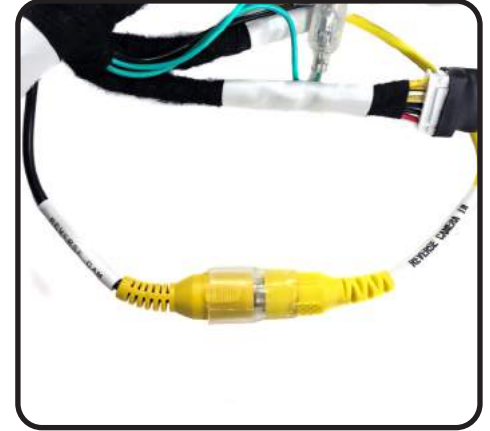

Step 3

Connect the Reverse Cam RCA on the SRK-CHR16-HAR to the Reverse Camera In on the HEIGH10 24-pin AV harness.

SRK-CHR15H

Stinger HEIGH10® Radio Replacement Kit

Installation Guide

2015-2021 Dodge Charger

Section 6: Display Mounting Panel Assembly



Step 1

Place the HEIGH10 display panel into the display mounting frame. While holding the display in place, carefully turn face down on a soft surface.



Step 2

Using four M4 X 12 screws from the HEIGH10 hardware, secure the display to the mounting panel.

Section 7: Radio Unit Installation

Part One: In-Vehicle Harness Connections

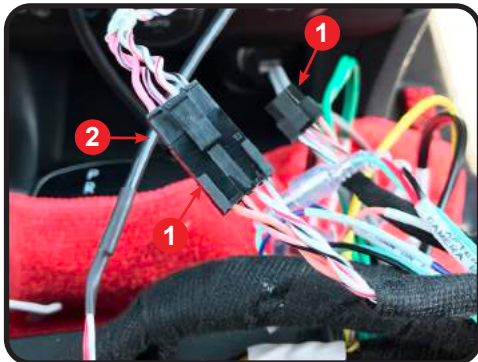

Step 1

Disconnect the 4-pin CAN connectors on the SRK-CHR16-HAR Main Harness (1). Connect the male 4-pin connector on the MGS4PT36V2 CAN harness (2) in the vehicle to the female 4-pin connector on the SRK-CHR16-HAR Main Harness.

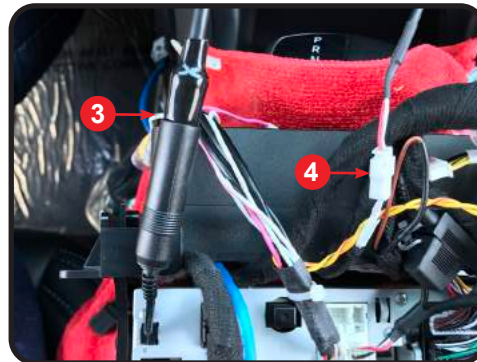

Step 2

Connect the AM/FM antenna lead to the HEIGH10 antenna input (3). Connect the 2-pin chime speaker connector to the 2-pin connector on the SRK-CHR16-HAR Main Harness (4).

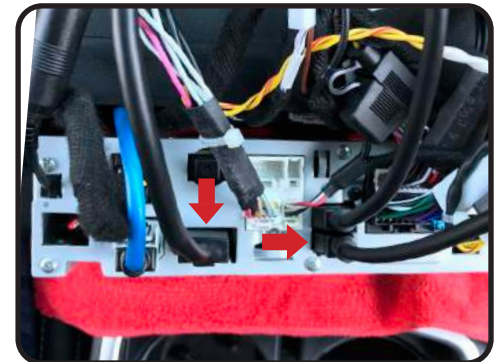

Step 3

Plug the HDMI cable into the HEIGH10 Radio Module. Plug the two USB cables into the HEIGH10 USB ports.
NOTE: The USB port closest to the edge of the radio module is used for Apple CarPlay and Android Auto.



SRK-CHR15H

Stinger HEIGH10® Radio Replacement Kit

Installation Guide

2015-2021 Dodge Charger

Section 7: Radio Unit Installation (cont.)

Part One: In-Vehicle Harness Connections (cont.)



Step 4

Connect the Red, White and Yellow RCA's from the media hub to the AUX IN inputs on the HEIGH10's 24-pin AV Harness.

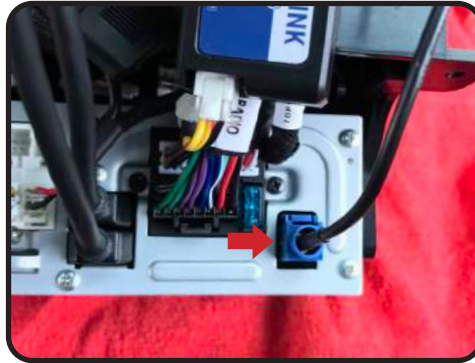

Step 5

Connect the blue GPS antenna connector to the radio module.



Step 6

Connect and lock the vehicle's 52-pin plug to the SRK-CHR16-HAR Main Harness plug.

These are the basic connections that provide full functionality of the radio. If installing additional components (external microphone, SXM tuner, amplifiers, etc) those connections should be made now before mounting the radio assembly.

Part Two: Mounting the Radio Module & Interface Assembly

These final installation steps show temporarily connecting some components and checking radio functions before reassembling the vehicle and permanently mounting the display screen.



Step 1

With the display cables routed out towards the front, position the radio assembly in place. Checking to make sure cables and connectors behind and below the radio are clear.

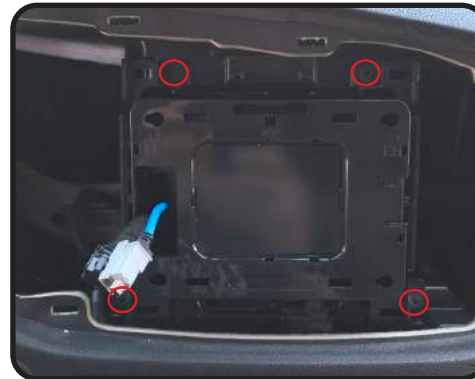

Step 2

Reinstall the four screws removed from the factory radio display to secure the assembly in place.



Step 3

Plug the two display cables into the back of the HEIGH10 display. Temporarily position the display to function test the unit before reassembly.



Section 7: Radio Unit Installation (cont.)

Part Three: Initial Boot Up and Function Tests

! Before turning on the ignition, close all the doors and lock the vehicle with the key fob. Wait ten minutes and then unlock and start the vehicle. The initial boot up may take up to 30 seconds before the display is active. Do not press the power button or turn off the vehicle during this time. Once powered up, refer to the included SRK-CHR15H Installer Set-Up Guide for access to the Installer Settings.

Function test all features, including volume, fade, balance, steering wheel controls, reverse camera, Bluetooth, USB, AUX and HDMI ports, AM/FM reception, Apple CarPlay and Android Auto.

NOTE: Only one of the two USB ports on the media hub will allow Apple CarPlay and Android Auto operation.

Check Vehicle Info and Climate Control sources. Refer to Troubleshooting section on next page if not present.

Check operation of vehicle's factory radio controls (Volume/Tune knobs, Mute, Power).

If the HEIGH10 external microphone was not installed, the default microphone setting of External must be changed to Internal by accessing the Phone Settings (**Main Menu>Phone>Settings>Microphone**).

Part Four: Attaching The Display Screen



Step 1

Unplug the display cables, if still attached from testing.



Step 2

Lower the steering column and reinstall the instrument cluster / radio trim panel.



Step 3

Reconnect the two display cables on the back of the HEIGH10 display screen.

Section 7: Radio Unit Installation (cont.)

Part Four: Attaching The Display Screen (cont.)

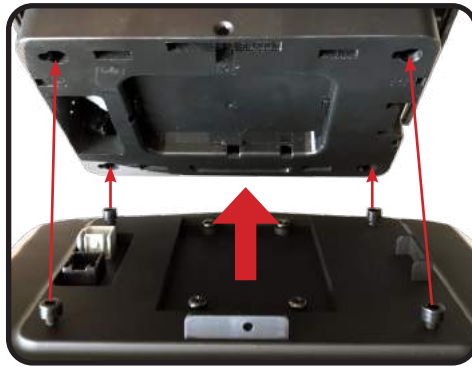

Step 4

Align and seat the four shoulder bolts on the back of the display to the four keyholes on the mounting bucket as shown at right.

(Display cables removed for illustration)

Once all four shoulder bolts are seated, slide the display to the left to lock the shoulder bolts in the key hole.

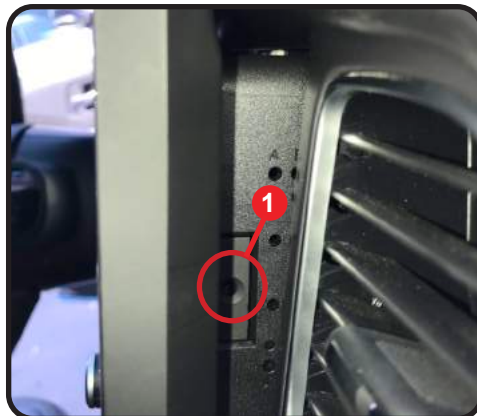

Step 5

Behind the display frame, on the right side is the display locking screw opening (1).

Using a magnetized Phillips screwdriver, install and tighten the black M4x8 set screw from the SRK-CHR15H hardware.

Troubleshooting

- 1. Vehicle Info icon not showing on main menu** - After updating the Radio System Firmware, perform a master reset on the radio by tapping “Master Reset” in the “Installer Settings”; then, update the PAC Application APK firmware in that order. If the Vehicle Info icon still does not show, turn off the vehicle, open the driver door, and let it sleep for about 5 minutes, then restart the vehicle and check for the Vehicle Info icon again.

CH4A-SRK Interface Module LED Diagnostics

| LED Pattern | State | Action |
|----------------------|---------------------------------|---|
| LED 2 solid red | Vehicle RAP / ACC Output Is On | N / A |
| LED 2 flashing green | SWC Activity | N / A |
| LED 2 flashing red | Module Resetting / Initializing | N / A |
| LED 1 solid green | Module Powered and Operating | N / A |
| LED 1 flashing amber | USB Connected | N / A |
| Off | No Activity | Verify key is in ignition position. Verify that there is 12v on the yellow wire and ground on the black wire. |

PL1 Adapter Module LED Diagnostics

| LED Pattern | State | Action |
|-----------------------------|---------------------------------------|---|
| LED flickering green or red | Data Communication / Normal Operation | N / A |
| Off | No Activity | Verify 10pin harness connections and key position |

Product Updates (Firmware)

Firmware Updates (RadioPRO and PL1 Interface Modules)

The RadioPRO PC app will allow you to update the interface modules with new firmware as it becomes available. Please visit www.PAC-audio.com/firmware to download available updates.

To update an interface module, open the RadioPRO PC app, connect the interface to your PC via a micro USB cable, and select “Firmware” and then “Update Firmware”.

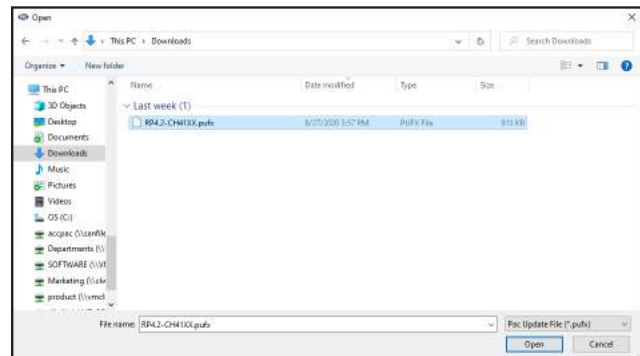

Now, select “Select File”. Finally, browse to the place where you saved the file, and select it. This will begin the updating process. Once finished, disconnect the interface from the PC. Repeat for each module: CH4A-SRK and PL1.

Firmware Updates (Stinger Radio and PAC Application APK)

To update the Stinger radio firmware and PAC Application APK firmware, refer to the Installer Setup Guide for an in-depth walk-through on how to perform these updates on your Stinger radio unit.

Reset / Restoring Interface Factory Settings

The RadioPRO interface module can be reset to factory default settings in two ways:

- By pressing and holding the programming button on the side of the module until the status LED starts blinking red. Once the LED starts blinking red, release the button. You must release the button while the LED is blinking red in order to perform the reset. This reset will restore all settings to factory defaults.
- In the Installer Settings on the HEIGH10. See included Installer Set Up Guide for more information.
(**Installer Settings > Advanced Vehicle Settings > About > RadioPRO ADVANCED > Factory Reset**)



Warranty

LIMITED WARRANTY

The quality controls used to manufacture PAC products are designed to ensure your complete satisfaction.

This warranty applies only to the original owner of PAC products purchased from an authorized PAC dealer. It covers PAC products that, upon inspection by authorized PAC personnel, are found to have failed in normal use due to defects in material or workmanship. This warranty does not cover installation expenses.

Attempting to service or modify our products, or operate them outside their recommended usage will render this WARRANTY VOID.

Unless prescribed by law, PAC is not liable for any personal injury, property damage and/or incidental or consequential damages (including water damage) resulting from product malfunctions, defects and/or misuse. PAC is also not liable for any products that are altered or improperly installed.

WARRANTY PERIOD AND PROCESS

Within the first 12 months from date of purchase, subject to the conditions above, PAC will repair or replace product at its sole discretion if it is found to be defective in material or workmanship. Product must be returned to an authorized PAC dealer with PROOF OF PURCHASE.

Technical Support

Email: support@PAC-audio.com

Phone: 727-592-5991

International: 866-931-8021

