

Overview:

The AP4-GM61 installation is done at the radio module. The radio module is located in various places throughout the different models of vehicles.

Example of IO4 / IO5 / IO6 Radio Module:

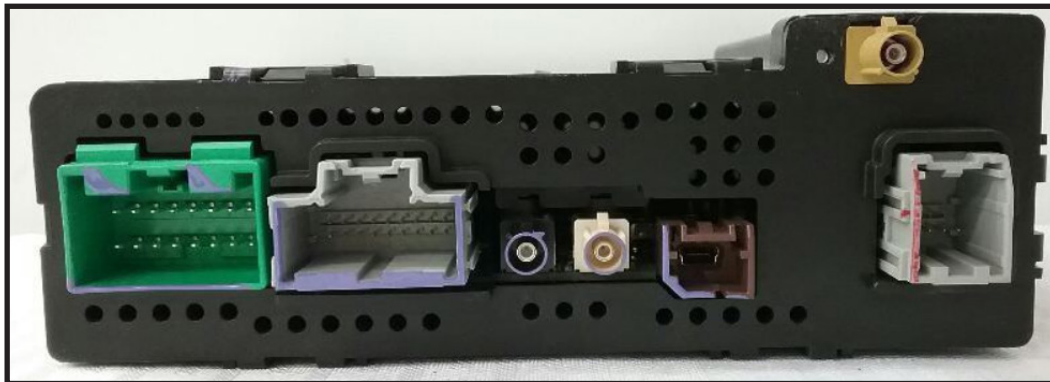

Notes:

In some cases, the vehicle's radio connectors will have a red locking tab that does not allow for the radio connector to be released until the locking tab is pulled away from the connector. When the locking tab is pressed almost flush against the face of the wire side of the connector, it is in a locked position. When the locking tab is extended away from the face of the wire side of the connector, it is unlocked, allowing for the connector release tab to press in fully. See the photo below for an example of how the release tab looks when the release tab is unlocked.

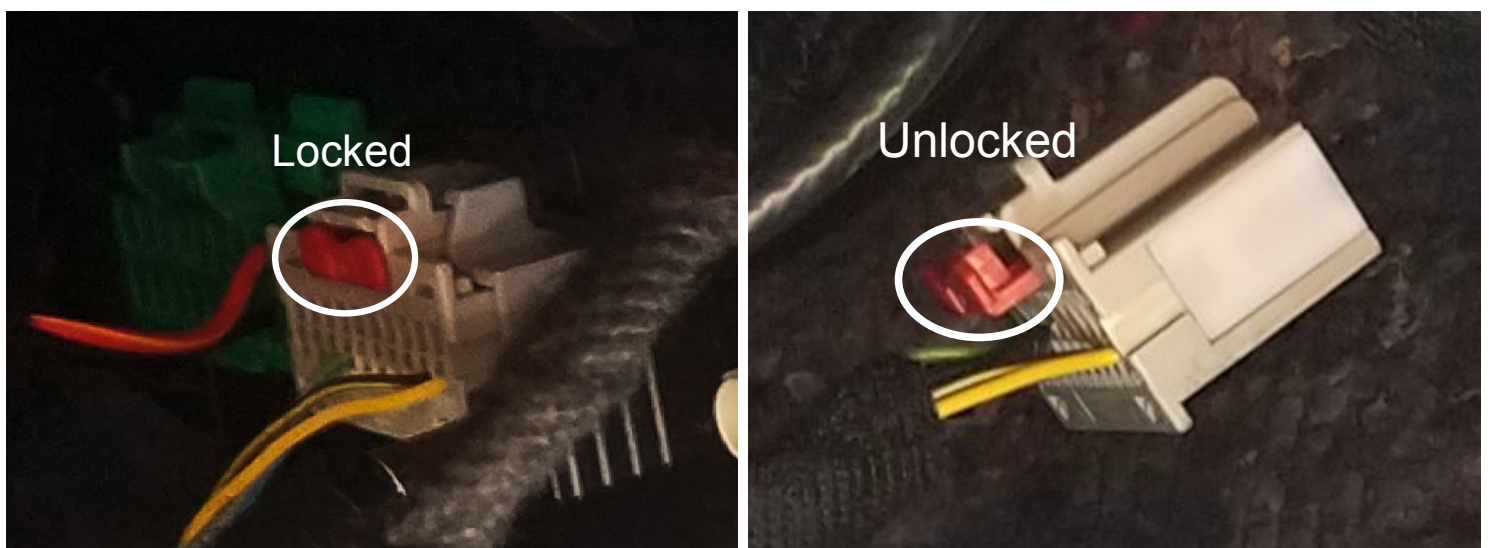

Vehicle Specific Info:

Silverado, Sierra, Colorado, Canyon

The radio module is located directly behind the radio's screen:

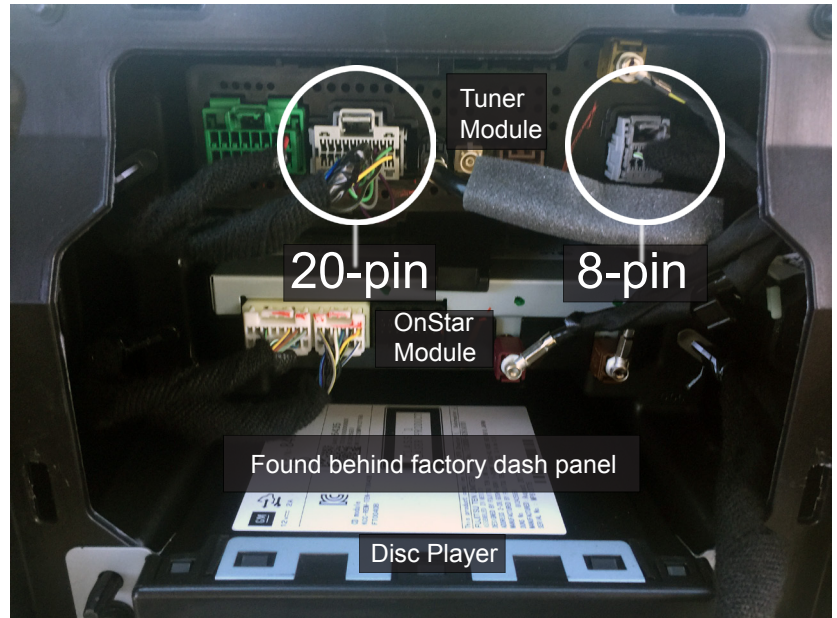

Tahoe, Suburban, Yukon, Yukon XL, Escalade

The radio module is located in the center of the dash, directly below the radio's screen, behind the climate controls:

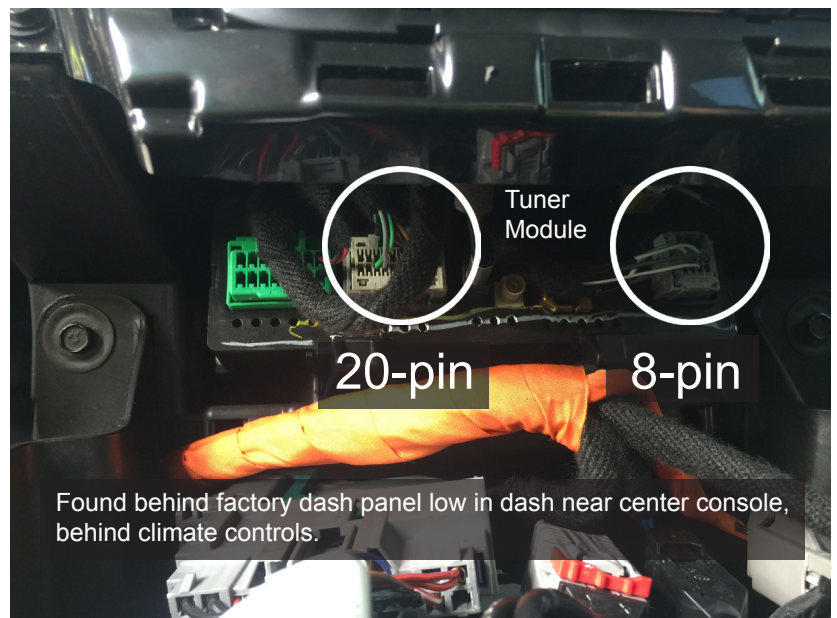

Equinox, Terrain

The radio module is located behind the glove box, close to the passenger kick panel with access from the bottom of the dash:

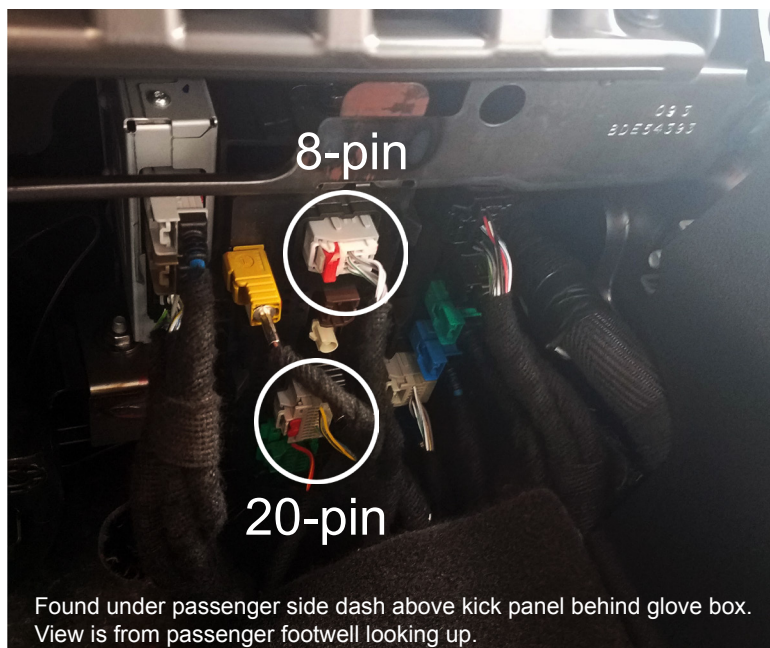

Traverse, Acadia

The radio module is located behind the glove box, close to the passenger kick panel. Access is from the bottom of the dash. It is necessary to remove a shroud to gain access to the tuner. The 8-pin and 20-pin connectors are facing the front of the vehicle, with the 8-pin connector being at the top:

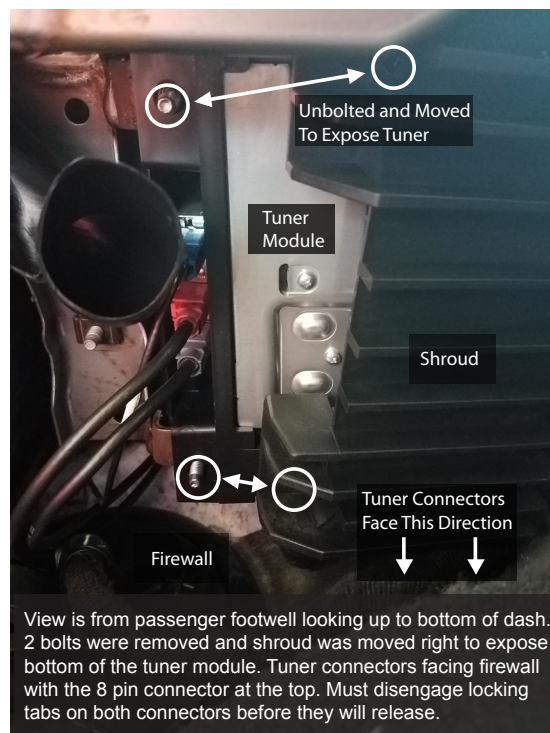

Camaro

The radio module is located behind the glovebox, above the passenger kick panel. Access from underneath the dash after pulling the under dash shroud (four 7mm bolts):

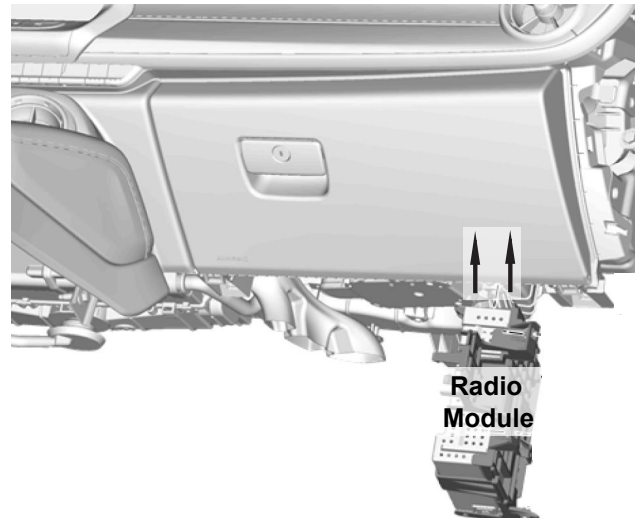

Corvette

The radio module is located in the floor of the passenger footwell (Fig. 1). Pull back the carpet in passenger footwell to access the BCM shroud (Fig. 2). Remove the bracket to access the BCM (Fig. 3). The radio module is located underneath the bracket that the BCM is attached to.

