

Jeep Wrangler JL 2018-up* & Gladiator JT 2020-up* Soundbar Speaker Kit

Visit Metraonline.com for more detailed information about the product and up-to-date vehicle specific applications.

Product Features

- Designed to adapt the factory 4" to 6.5" with a tweeter option
- Speaker depth 3 5/8"
- Mounting plate/cutting template included
- Hardware included
- Harness included (12")



Part Components

A) Speaker covers B) Mounting/Cutting Template C) Harness and Hardware



TABLE OF CONTENTS

Soundbar Removal	2
Template cutting.....	3-4
Re-assembly	5
Speaker install.....	6
In box components and measurements.....	7-8

TOOLS REQUIRED

- 3/16 Allen bit
- Phillips bit
- Reciprocating saw or other cutting device

Attention! When testing the aftermarket equipment, ensure that all factory equipment is connected before cycling the key to ignition.

SOUNDBAR REMOVAL

Removal

1. It is highly recommended that the sound bar be removed for install of this speaker adapter kit.
2. Remove all panels along the top trim of the vehicle to gain access to the soundbar. (Figure A)
3. Remove all the screws holding the sound bar to the vehicle. Please be careful and have access to help if needed to not break or damage the vehicle or soundbar. (Figure B)
4. Unplug the harness and remove soundbar from the vehicle.

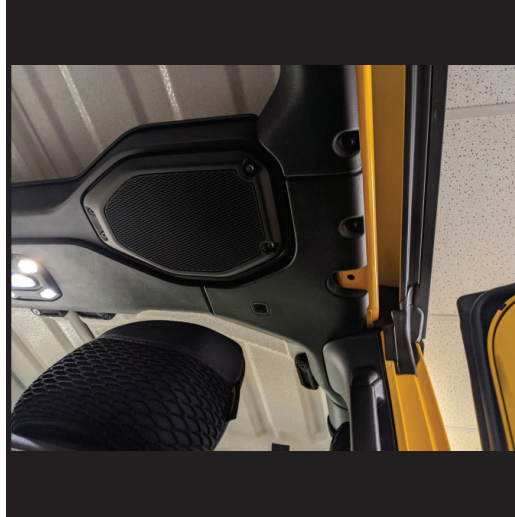

Figure A



Figure B

TEMPLATE CUTTING

1. Remove the screws holding the grill in place.
 2. Remove the speakers from the soundbar.
 3. Carefully hide the harness in the soundbar as to not cut the wiring while cutting the interior structure of the soundbar.
 4. Place the template in place and secure with the provided (9) screws. (Figure A)
 5. Trace the area highlighted in Figure B and remove template, this will be the area that needs to be cut.
- NOTE: Only trace and cut the smaller circle if a tweeter is being used.

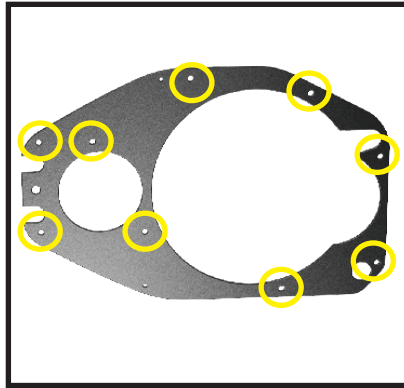

Figure A

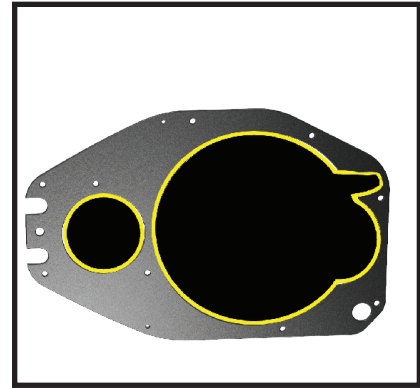

Figure B

TEMPLATE CUTTING (CONT.)

5. Remove the template and cut the traced area carefully. Be sure not to cut through the back of the soundbar and not to cut through the wiring in the bar. Also be careful not to cut the 4 outer most threaded holes as those will be used to secure the grill.
6. Figure D is with the section cut out and removed. Re-install the metal cutting template. This will be used as a mounting surface for the grill.



Figure C



Figure D

RE-ASSEMBLY

Assembly

1. After re-installing the metal cutting template using the (9) provided screws, line up the grille and check the cut made previously. (Figure A)
2. Make sure the speaker fits properly and the depth is good. Depth is 3 5/8".
3. If everything is good, attach grille using the provided (6) screws. (Figure B)



Figure A



Figure B

SPEAKER INSTALL

Install

1. Install the desired speaker, attach harness to speaker pod wiring and speaker. Mount the speaker using the mounting holes that are provided. Not all holes are needed for mounting. (Figure A)
2. Use with desired speaker grille provided with speaker. This adapter will also work with our Metra speaker grille BC-SPG. (Figure B)
3. Repeat previous steps on opposite side of soundbar.



Figure A



Figure B

IN BOX COMPONENTS



Grille Replacement (2)



Speaker mounting screws (8)



Grille replacement mounting screws (12)



Cutting template/grille support screws (20)

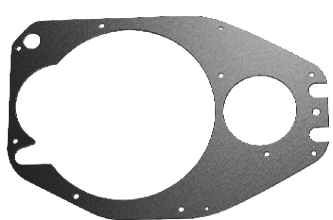

Cutting Template/grille support (2)

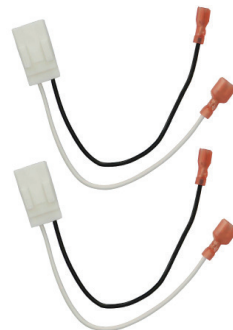
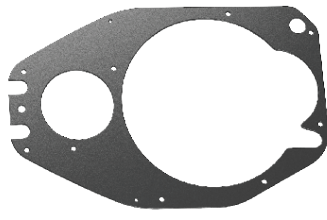

Speaker Harness (2)

Sound deadening padding included, not pictured (2)



JP-1015

INSTALLATION INSTRUCTIONS

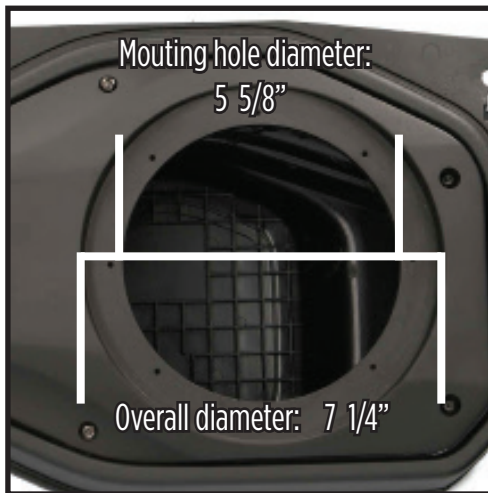
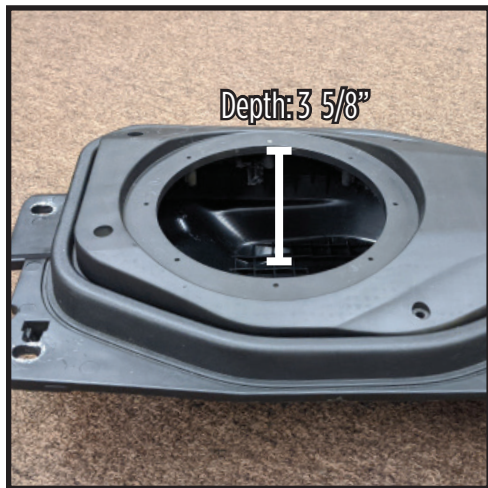

Having difficulties? We're here to help.



Contact our Tech Support line at:
386-257-1187



Or via email at:
techsupport@metra-autosound.com

Tech Support Hours (Eastern Standard Time)

Monday - Friday: 9:00 AM - 7:00 PM

Saturday: 10:00 AM - 7:00 PM

Sunday: 10:00 AM - 4:00 PM



KNOWLEDGE IS POWER

Enhance your installation and fabrication skills by enrolling in the most recognized and respected mobile electronics school in our industry. Log onto www.installerinstitute.com or call 800-354-6782 for more information and take steps toward a better tomorrow.



**Metra Recommends MECP
certified technicians**