



INTERFACE COMPONENTS

- AXDSPL-M11 interface
- AXDSPL-M11 interface harness
- AXDSPL-M11 vehicle T-harness
- Bass knob

APPLICATIONS

Visit axsessinterfaces.com for current application list

Mitsubishi DSPL Interface w/ Pre-Wired Harness (for non-amplified vehicles) 1993-2012

INTERFACE FEATURES

- Includes a DSP (Digital Signal Processor)
- Selectable 15 Band graphic EQ or 5 Band Parametric EQ
- 4 inputs and 6 individually assignable outputs
- Independent equalization for front, rear, and sub
- Selectable low pass, band pass, and high pass filters
- Selectable crossover slopes; 12db, 24db, 36db, 48db
- Each channel can be delayed independently up to 10ms
- Clipping detection and limiting circuits
- Designed for non-amplified models
- Easy behind the radio installation with pre-wired harness
- Internal header port for adding interface modules
- Bass knob included for level control of subwoofer amp
- Settings adjusted via Bluetooth[®] in a smart device application (tablet or mobile phone), compatible with both Android and Apple devices
- Read, write, and store configurations for future recall
- Password protect feature available in the mobile app
- USB Micro B updatable

TABLE OF CONTENTS

Installation Options	2
Installation	2
Connections	3-4
AXDSPL-BT Installation	5
AXDSPL-SP Installation	6
Mobile App	7-15
Specifications	16

TOOLS & INSTALLATION ACCESSORIES REQUIRED

- Crimping tool and connectors, or solder gun, solder, and heat shrink
- Tape
- Wire cutter
- Zip-ties
- Multimeter

Google Play Store



Apple App Store

iOS 12.1 or higher



INSTALLATION OPTIONS

Adding a subwoofer to a factory system:

The diagram on **Page 3** shows the connections that need to be made to add a subwoofer to the factory system. **Note:** RCA jacks sold separately.

Adding a full-range of amps & subwoofer to a factory system:

The diagram on **Page 4** shows the connections that need to be made to add: Subwoofer (RCA jacks sold separately).

Amplifier (SPDT relay **E-123** required) or Additional Amp (RCA jacks sold separately).

16-pin header port:

Inside the interface is a 16-pin header port for adding optional modules (sold separately). Pages 5 and 6 will show the installation and use of these modules.

- **AXDSPL-BT** - Bluetooth streaming interface
- **AXDSPL-SP** - Toslink digital output

Note: The interface provides a 12-volt 1-amp output to turn on aftermarket amp(s). If installing multiple amps, an SPDT automotive relay will be required if the amp turn-on current of all amps combined exceeds 1-amp. Use Metra part number [E-123](#) (sold separately) for best results.

INSTALLATION

1. Disassemble the dash, unplug all connectors, and then remove the factory radio. †
2. Install the **AXDSPL-M11 vehicle T-harness** to the vehicle and make all necessary connections, but leave the amp turn-on wire disconnected.
3. Plug the **AXDSPL-M11 vehicle T-harness** to the **AXDSPL-M11 interface**.
4. Plug the **AXDSPL-M11 interface harness** to the **AXDSPL-M11 interface**.
5. Download and install the **AX-DSP-XL app** from the **Google Play Store** or **Apple App Store**.
6. Cycle the ignition on.
7. Open the app then select the **Bluetooth Connection** tab. Follow the instructions to pair the mobile device to the interface. Refer to [page 7](#) for more information.
8. Scroll to the **Configuration** tab then select the vehicle type. Press the **Lock Down ‡** button to save the configuration. Refer to [page 8](#) for more information.
9. Connect the amp turn-on wire.
10. Adjust the settings in the app as desired. Press the **Lock Down ‡** button to save any new configurations.

† For dash disassembly instructions, refer to [metraonline.com](#). Enter the year, make, and model of the vehicle in the Vehicle Fit Guide and find instructions under Metra Radio Install kits.

‡ Anytime the interface is locked down the key must be cycled off then back on.

CONNECTIONS: ADDING A SUB TO A FACTORY SYSTEM

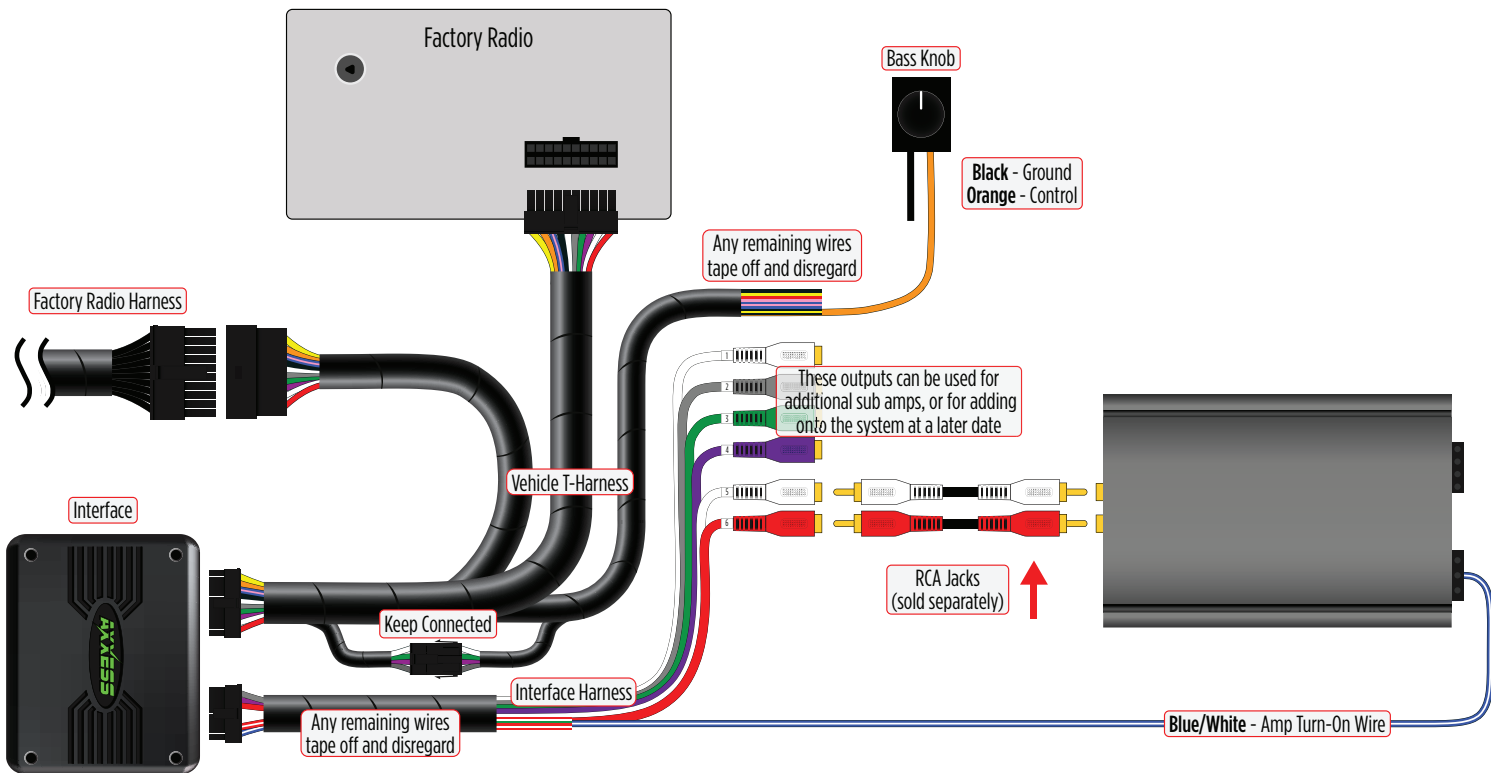

CONNECTIONS: ADDING A FULL-RANGE AMP & SUB TO A FACTORY SYSTEM

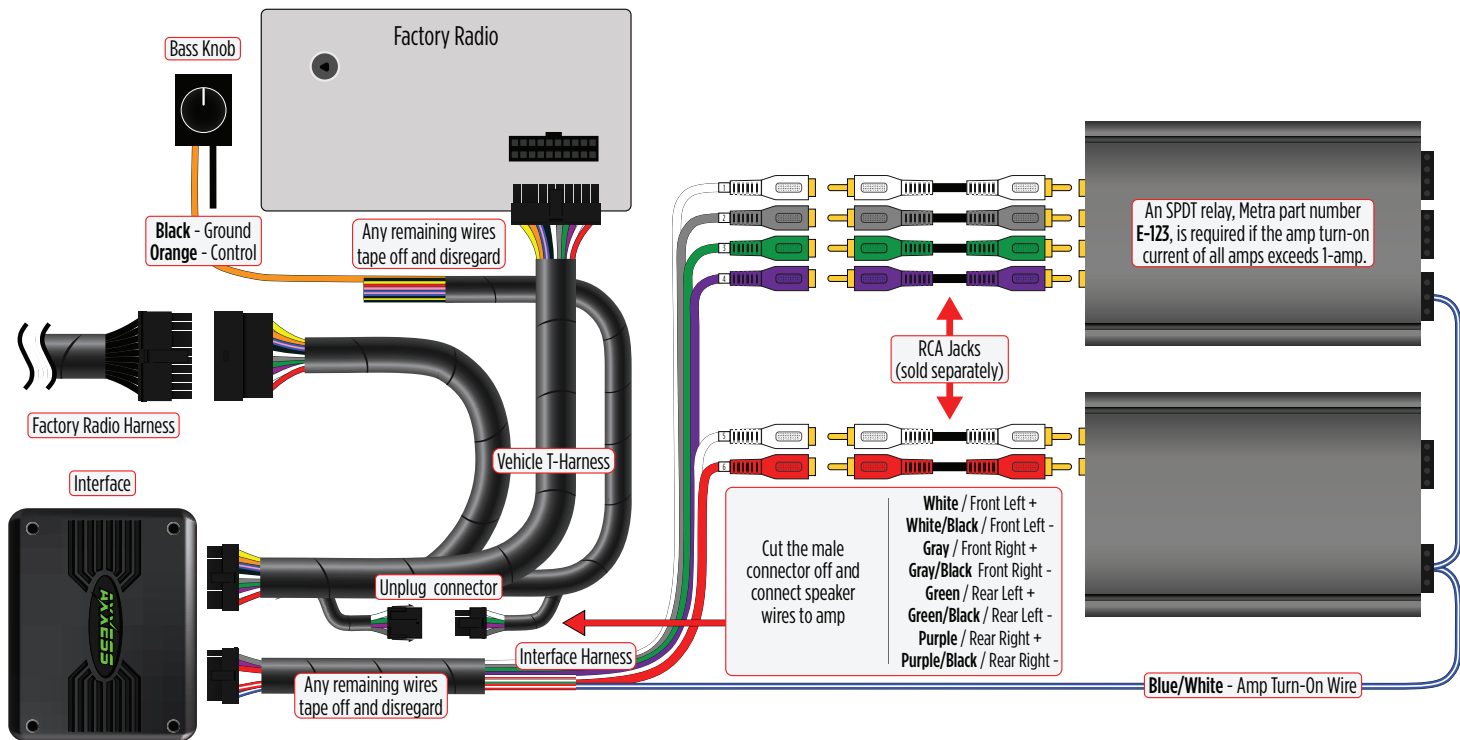

BLUETOOTH STREAMING INTERFACE

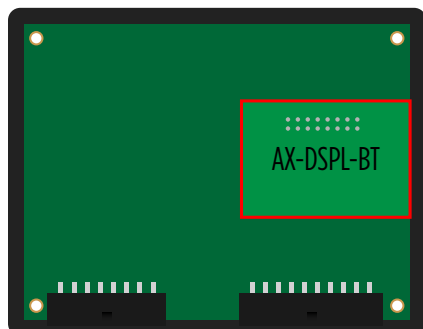
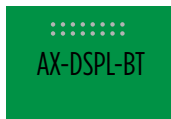
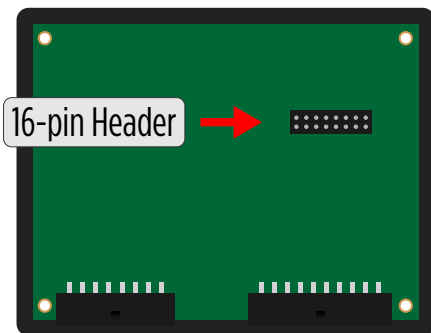

- The **AXDSPL-BT** Bluetooth streaming interface can be used to stream media directly to the interface.
- While streaming media the volume on the phone will be used. As an option, the **AXBK-1** (sold separately) can be used to control the volume.

Note: The bass knob included with the **AXDSPL-M11** can be used if it will not be used to control a subwoofer.

1. **Important!** Unplug the interface from the vehicle.
2. Remove (4) Phillips screws securing the interface, then remove the top cover, exposing the circuit board within.
3. Locate the 16-pin header on the circuit board.
4. **Important!** Referencing how the **AXDSPL-BT** is laid out in the picture, carefully line up the header pins to the interface. Gently press down to secure.

Note: Both interfaces may be damaged if installed incorrectly.

5. Re-secure the top cover using the (4) Phillips screws previously removed to complete the installation.

AXBK-1 Installation:

6. Connect the **Brown** wire from the interface to the **Orange** wire from the **AXBK-1**. Ground the **Black** wire from the **AXBK-1** to the chassis.

Continued on the next page

TOSLINK DIGITAL OUTPUT

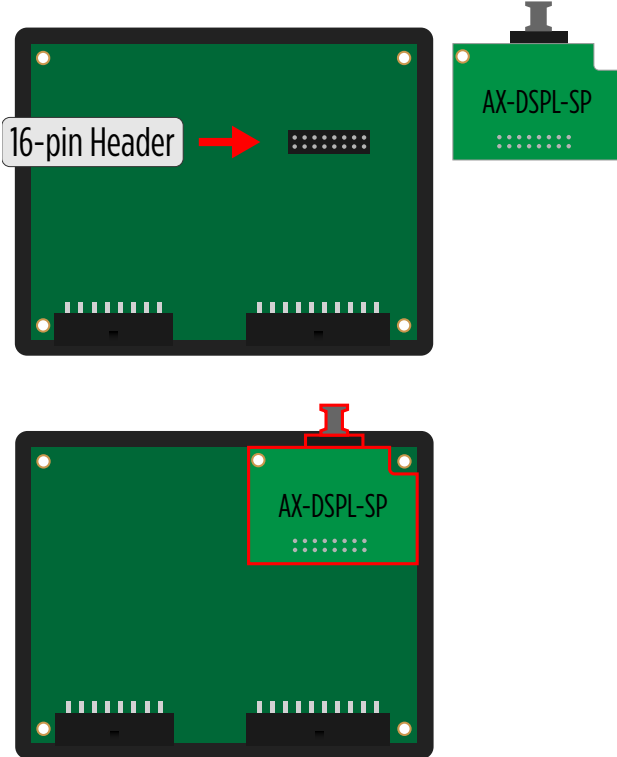

- The **AXDSPL-SP** Toslink digital output can be used for adding a digital output to the interface.
1. **Important!** Unplug the interface from the vehicle.
 2. Remove (4) Phillips screws securing the interface, then remove the top cover, exposing the circuit board within.
 3. Locate the 16-pin header on the circuit board.
 4. **Important!** Carefully line up the header pins to the **AXDSPL-SP**, with the Toslink port facing outward. Gently press down to secure.
- Note:** Both interfaces may be damaged if installed wrong.
5. Re-secure the top cover provided with the **AXDSPL-SP** using the (4) Phillips screws previously removed to complete the installation.

Continue to Mobile App

Setup Instructions

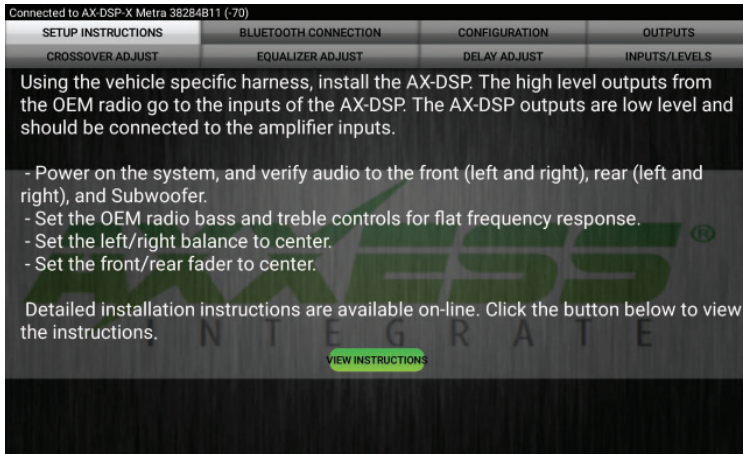

- General information tab for installing the interface.

Bluetooth Connection

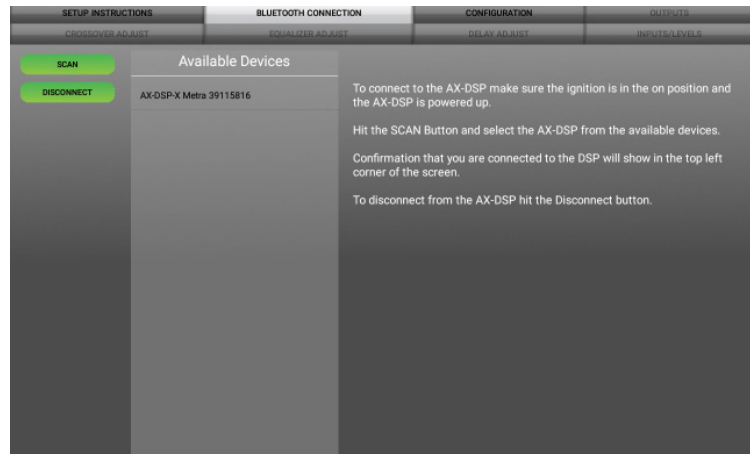

- **Scan** - Press this button to start the Bluetooth pairing process, then select the Available Device once it is found. "Connected" will appear in the top left corner of the app once paired.
- **Note:** The ignition must be cycled on during this process.
- **Disconnect** - Disconnects the interface from the app.

Continued on the next page

Configuration

IDENTIFY: Click this button to confirm that the interface is connected properly. If it is, a chime will be heard from the front left speaker.*

* Only installations where the interface is connected to a front left speaker.

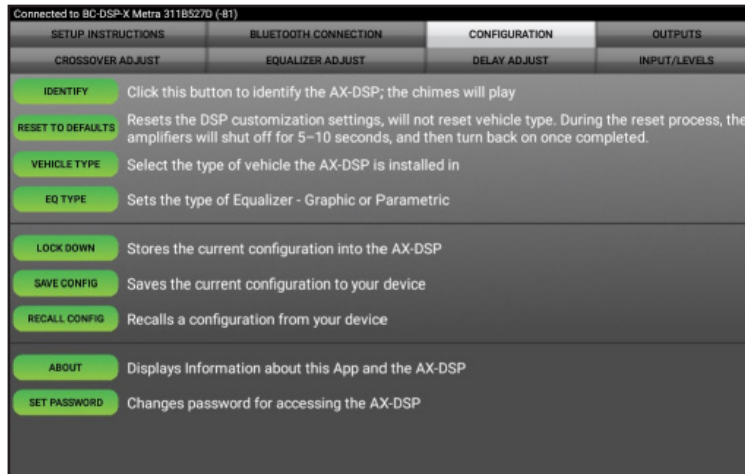

RESET TO DEFAULTS: Resets the interface to factory settings. During the reset process the amplifiers will shut off for 5-10 seconds.

VEHICLE TYPE: Select the vehicle type from the drop down box, select **EITHER**

EQUALIZER (EQ) TYPE: User has the option of optimizing the car's sound quality with a Graphic or Parametric equalizer.

LOCK DOWN: Click this button to save the selected settings.

Attention! This button must be selected before closing the app or cycling the key; otherwise, all settings will be lost.

SAVE CONFIGURATION: Saves the current configuration to the mobile device.

RECALL CONFIGURATION: Recalls a configuration from the mobile device.

ABOUT: Displays information about the app, vehicle, interface, and mobile device.

SET PASSWORD: Assign a 4-digit password to lock the interface. If no password is desired, use "0000". This will clear out any currently set password. It is not necessary to lock down the interface when setting a password.

Note: A 4-digit only password must be chosen; otherwise, the interface will show "password not valid for this device".

Continued on the next page

Outputs

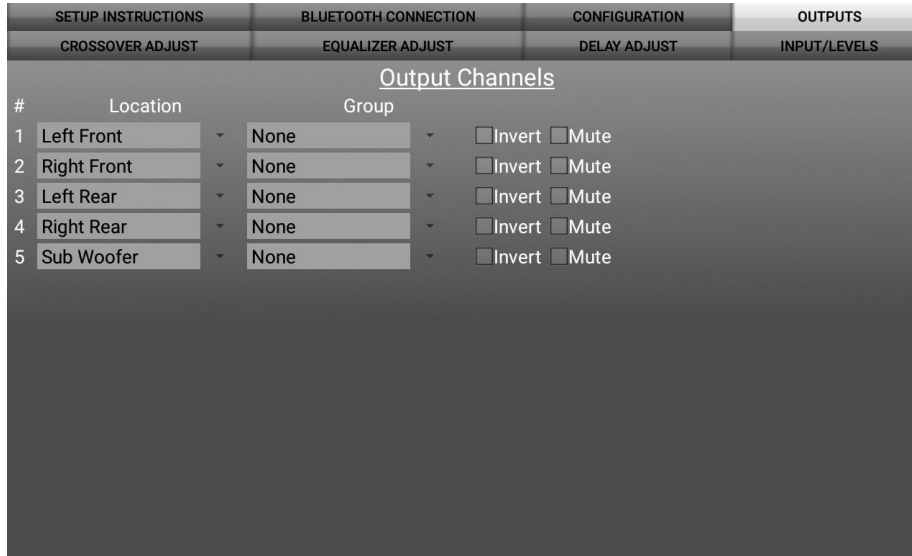

Output Channels

- **Location** - Location of speaker.
- **Group** - Used to join channels together for simple equalization. Example, left front woofer/midrange and left front tweeter will be considered simply left front. The letter **M** indicates the speaker assigned as the master speaker.
- **Invert** - Will invert the phase of the speaker.
- **Mute** - Will mute desired channel(s) for tuning individual channels.

Continued on the next page

Crossover Adjust

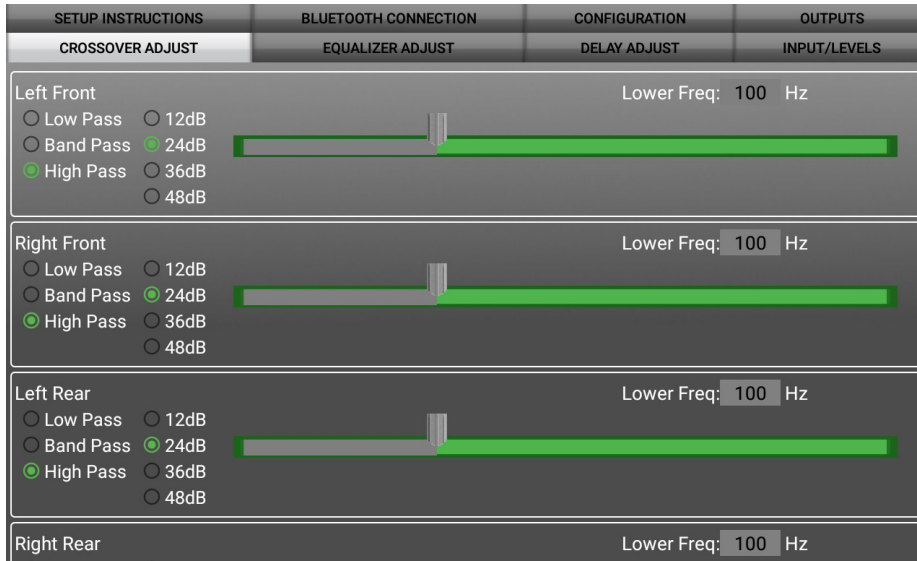

- Selecting **High Pass** and **Low Pass** will provide one crossover frequency adjustment. Selecting **Band Pass** will provide two crossover frequency adjustments: one for low pass, and one for high pass.
- Select the desired crossover slope per channel, 12db, 24db, 36db, or 48db.
- Select the desired crossover frequency per channel, 20hz to 20khz.

Note: The front and rear channels default to a 100Hz high pass filter to keep the low frequency signals out. If a subwoofer is not being installed, change the front and rear crossover points down to 20Hz for a full range signal, or to the lowest frequency the speakers will play.

Continued on the next page

Equalizer Adjust

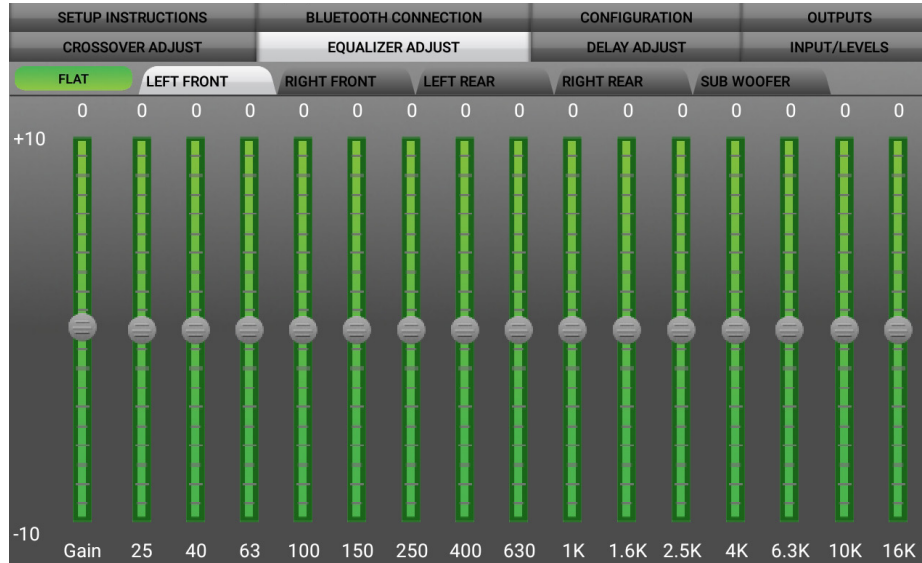

Graphic EQ

- All channels can be adjusted independently within this tab with 15 bands of available equalization. It is best to tune this by using an RTA (Real Time Analyzer).
- The **Gain** slider on the far left is for the channel selected.

Continued on the next page

Parametric EQ

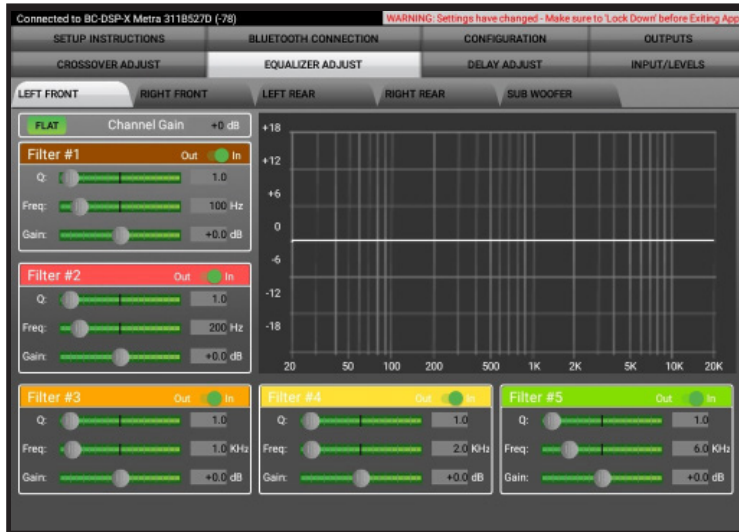

Each output has a **5 Band parametric EQ** per channel. Each band will give the user the ability to adjust:

- Q Factor
- Frequency
- Gain

The **FLAT** button above **Filter #1** will reset all curves back to flat.

Continued on the next page

Delay Adjust

SETUP INSTRUCTIONS	BLUETOOTH CONNECTION	CONFIGURATION	OUTPUTS
CROSSOVER ADJUST	EQUALIZER ADJUST	DELAY ADJUST	INPUTS/LEVELS

Distance from each speaker to 'Head' position (in inches)



Left Front	0
Right Front	0
Left Rear	0
Right Rear	0
Sub Woofer	0

Measure the distance from each speaker to the desired 'Head' position and enter those values in the corresponding boxes. Maximum distance is 99".

- Allows a delay of each channel. If a delay is desired, first measure the distance (in inches) from each speaker to the listening position, then enter those values to the corresponding speaker. Add (in inches) to the desired speaker to delay it.

Continued on the next page

Inputs/Levels

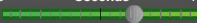
SETUP INSTRUCTIONS	BLUETOOTH CONNECTION	CONFIGURATION	OUTPUTS
CROSSOVER ADJUST	EQUALIZER ADJUST	DELAY ADJUST	INPUT/LEVELS
<u>Chime Volume</u>			
<p>Volume: 3 Low Medium High</p>  <p>The Chime Volume control is provided to prevent warning tones from being overly loud.</p>			
<u>Clipping Level</u>			
<p>Off <input type="radio"/> On <input checked="" type="radio"/> Level: 5 Soft Demo Hard</p>  <p>The AX-DSP can detect clipping of the audio signals and reduce the level for a period of time to prevent damage to the speakers.</p>			
<u>Amp Turn On</u>			
<p>Turn On Delay: 6 0 Seconds 10</p>  <p><input checked="" type="radio"/> Signal Sense <input type="radio"/> Always On</p> <p>The AMP ON line can be turned on whenever accessory power is on, or only when a signal is detected from the radio.</p>			
<u>Subwoofer Input</u>			
<p><input checked="" type="radio"/> Front + Rear <input type="radio"/> Subwoofer</p> <p>The Subwoofer output can be driven from the sum of the Front and Rear inputs, or it can be from the Subwoofer input only.</p>			

- **Chime Volume** - Not applicable in this application.
- **Clipping Level** - Use this feature to protect sensitive speakers like tweeters from being driven past their capabilities. If the output signal of the interface clips the audio will be reduced by 20dB. Turning down the stereo will allow the audio to come back at a normal level. The sensitivity of this feature can be adjusted to the listening preference of the user.
- **Amp Turn On**
 - **Signal Sense** - Will turn the amp(s) on when an audio signal is detected, and keep on for (10) seconds after the last signal. This ensures the amp(s) won't shut off between tracks.
 - **Always On** - Will keep the amp(s) on as long as the ignition is cycled on.
 - **Turn on Delay** - Can be used to delay audio output to avoid turn-on pops.
 - **Subwoofer Input** - Select **Front + Rear** or **Subwoofer** depending on preference.

Continued on the next page

Locking Down Data

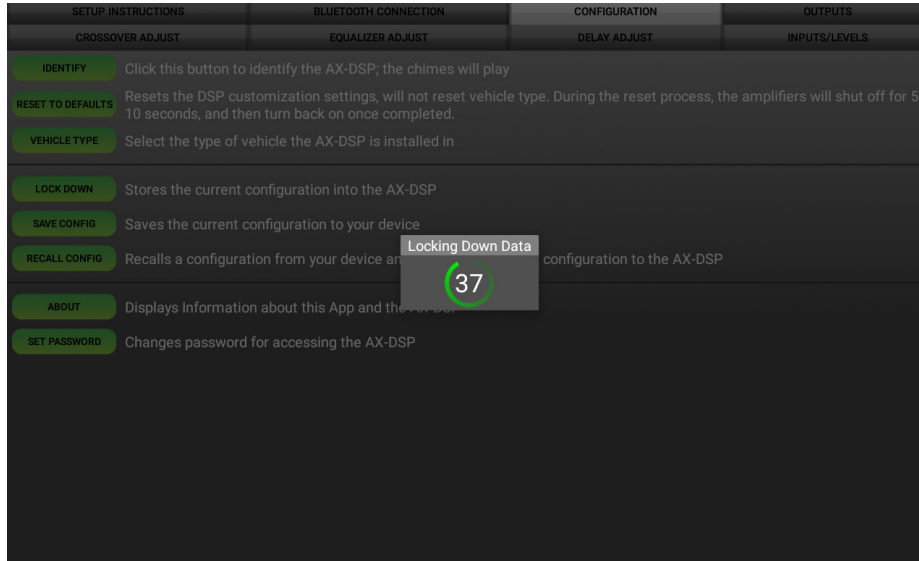

**Last and the most important.
You must lock down your
configuration and cycle the key!!!**

SPECIFICATIONS

Input Impedance	1M Ohm	Crossover Filter	Low pass, band pass, high pass
Input Channels	6	Crossover Frequency	Selectable 20hz to 20khz
Input Options	High Level or Low Level	Crossover Slope	12db/24db/36db/48db
Input Type	Differential balanced	Crossover Type	Linkwitz-Riley
Input Voltage (high level range)	0 - 28-volts (peak-to-peak)	Sampling	48kHz
Input Voltage (low level range)	0 - 4.9-volts (peak-to-peak)	S/N Ratio	105dB @ 5-volts RMS
Output Channels	6	Operating Voltage	10-16 volts DC
Output Voltage	Up to 5-volts RMS	Standby Current Draw	7mA
Output Impedance	50 Ohms	Operation Current Draw	150mA
Equalizer Type	15 Band Graphic EQ, +/- 10dB	Adjustments/Controls	Application via Bluetooth
THD	<0.03%	Remote Output	12 volts DC (signal sense) or ignition on
Frequency Response	20Hz - 20kHz		

Having difficulties? We're here to help.



Contact our Tech Support line at:
386-257-1187



Or via email at:
techsupport@metra-autosound.com

Tech Support Hours (Eastern Standard Time)

Monday - Friday: 9:00 AM - 7:00 PM

Saturday: 10:00 AM - 7:00 PM

Sunday: 10:00 AM - 4:00 PM



KNOWLEDGE IS POWER

Enhance your installation and fabrication skills by enrolling in the most recognized and respected mobile electronics school in our industry. Log onto www.installerinstitute.edu or call 386-672-5771 for more information and take steps toward a better tomorrow.



**Metra recommends MECP
certified technicians**