



EN

FR

ES

7-INCH AUDIO/VIDEO RECEIVER

iLX-407

- OWNER'S MANUAL
Please read before using this equipment.
- MODE D'EMPLOI
Veuillez lire avant d'utiliser cet appareil.
- MANUAL DE OPERACIÓN
Léalo antes de utilizar este equipo.

Thank you for purchasing this Alpine product. Please take a moment to protect your purchase by registering your product now at the following address: www.alpine-usa.com/registration.
You will be informed of product and software updates (if applicable), special promotions, news about Alpine.

Merci d'avoir acheté ce produit Alpine. Nous vous invitons à consacrer un moment à la protection de votre achat en enregistrant votre produit dès maintenant à l'adresse suivante : www.alpine-usa.com/registration.
Vous serez tenu informé des mises à jour des produits et des logiciels (le cas échéant), des promotions spéciales et de l'actualité d'Alpine.

Gracias por adquirir este producto Alpine. Con solo unos pocos pasos podrá proteger su producto, registrándolo a través de la siguiente dirección: www.alpine-usa.com/registration.
Recibirá información sobre nuevos productos y software, promociones especiales y novedades sobre Alpine.

ALPINE ELECTRONICS OF AMERICA, INC.

1500 Atlantic Blvd,
Auburn Hills, Michigan 48326, U.S.A.
Phone 1-800-ALPINE-1 (1-800-257-4631)

ALPINE ELECTRONICS OF AUSTRALIA PTY. LIMITED

161-165 Princes Highway,
Hallam Victoria 3803, Australia
Phone 03-8787-1200

ALPS ALPINE EUROPE GMBH

Ohmstrasse 4, 85716 Unterschleissheim, Germany
Phone: +49 (0) 89-32 42 640
For contact information on your respective country,
please visit www.alpine-europe.com.

ALPS ALPINE ASIA CO., LTD.

The 9th Towers, Tower B, 24th Floor, Unit TNB01-03,
33/4 Rama 9 road, Huay Kwang, Bangkok, 10310, Thailand
Phone +66 (2) 090 9596

Designed by ALPS ALPINE Japan

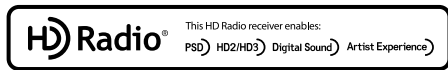

CONTENTS

Operating Instructions

PRECAUTIONS

IMPORTANT INFORMATION6

WARNING

Points to Observe for Safe Usage6

WARNING6

CAUTION.....7

NOTICE.....8

Getting Started

Location of Controls 10

Turning Power On or Off..... 10

Adjusting the Volume 10

Lowering Volume Quickly 10

Touch Screen Operation 11

Switching Sources..... 11

Selecting an Item in a List 11

About the HOME Screen..... 12

Editing HOME screen 12

About the Indicator Display 13

Setup

Setup Operation 13

General Setup

Radio Setup 14

Setting the TUNER (FM) Tone Quality

(Tuner Condition) 15

Setting the TUNER (FM) Frequency Step 15

Setting the Ballgame Mode..... 15

SiriusXM Setup 15

Setting the Parental Lock 15

Signal Strength Information 16

AUX Setup 16

Setting the AUX Select 16

Setting the Input Signal..... 16

Setting the Display Mode..... 16

Language Setup 16

Wallpaper Setup 17

Setting a Wallpaper using a default image..... 17

Setting a Wallpaper using your image 17

Screen/LED Customize Setup 17

Setting the Brightness of the Backlighting

(Dimmer)..... 17

Adjusting the Minimum Level of Backlight 17

Adjusting the Dimmer of Button Lighting at

Night..... 18

Date/Clock Setup 18

Display Off Setting..... 18

About iLX-407 18

Displaying the Product Information..... 18

Displaying Warranty/Copyright Information... 18

Initializing the System 18

Installation Setup 19

Steering Wheel Position Setting 19

Mute Setting 19

iDatalink Setting 19

Setting the Default Vehicle Screen 19

Setting the Parking Assist Enable..... 19

Setting the Maestro Module 19

Connection (Bluetooth) Setup

Displaying Bluetooth Information 20

Pairing the Bluetooth Device 20

Setting the Bluetooth Device 20

Deleting a Bluetooth Device from the list..... 20

Apple CarPlay Setup..... 21

Camera Setup

Rear Camera Setup 21

Camera Input Setting 21

Camera Signal Input Setting 21

Rear Camera Guide Settings 22

Camera Picture Quality Setup 22

Camera Interrupt Setting

(DISPLAY OFF Mode)..... 22

Front Camera Setup 23

Camera Input Setting 23

Camera Signal Input Setting 23

Camera Picture Quality Setup 23

Sound Setup

Setting the Media Xpander (MX) 24

Equalizer Settings..... 24

Fader/Balance/Bass/Treble/Subwoofer	
Settings.....	24
Setting the Fader/Balance	25
Adjusting the Bass/Treble	25
Setting the Subwoofer	25
Graphic Equalizer Curve Settings (Graphic EQ)...	25
Time Correction Settings.....	26
Crossover Settings (X-Over).....	26
Volume Setup	27
Adjusting the Key Sound.....	27
Adjusting the Source Volume.....	27
Setting the Volume for Android Auto™.....	27
Setting the Volume for Apple CarPlay	27
Adjusting the Volume for Phone	27
Turning Subwoofer ON/OFF.....	27
Rear Speaker Setting.....	28
Defeat Setting.....	28
About the Crossover	28
About Time Correction.....	29

Apple CarPlay (Optional)

Access to Apple CarPlay.....	31
------------------------------	----

Android Auto (Optional)

What is Android Auto	31
Activate Android Auto.....	31

Radio/HD Radio™/RBDS

Radio Basic Operation

Listening to the Radio	32
Presetting Stations Manually	33
Presetting Stations Automatically.....	33
Tuning to Preset Station	33
Receiving a Multicast (HD Radio™ Mode only) ...	33
Forced Analog Mode.....	33
Selecting the Receivable Program Type	
(RBDS FM Radio Mode only)	33
Using Ballgame Mode (HD Radio™ Mode only) ...	34
Displaying Radio Text (HD Radio™/	
RBDS FM Radio mode only)	34
About the Feature Logos.....	34

USB Flash drive (Optional)

USB Audio

Playback.....	35
Repeat Play.....	35
Shuffle Play.....	36

Searching for a Desired Song.....	36
-----------------------------------	----

USB Video

Fast-forwarding/Fast-reversing	37
Stopping Playback.....	37
Repeat Play	37
Searching for a Desired file.....	37
Setting the Brightness and Contrast	37
Displaying the Subtitle.....	37

USB Photo

Playback.....	38
Slide Show	38
Setting a Wallpaper with a Photo.....	38

iPod mode on iPhone (Optional)

Playback.....	39
Searching for a Music File.....	40
Repeat Play	40
Shuffle Play	40

SiriusXM Satellite Radio Operation (Optional)

Receiving Channels with the SiriusXM Tuner.....	41
Tuning Channels by Category	41
Changing the Display	42
Checking the SiriusXM Radio ID Number.....	42
Storing Channel Presets.....	42
Tuning Channels using Presets	42
Search Function	42
Selecting the Channel Directly.....	42
Parental Lock Function.....	43

HDMI Device (Optional)

HDMI Operation.....	44
Setting the Brightness and Contrast	44

Bluetooth Operation

Setup Before Using	45
About Bluetooth.....	45
About the Hands-free Phone.....	45
Before Using Bluetooth.....	45

Hands-free Phone Control

Answering a Call	46
Hanging up the Telephone.....	46
Calling.....	46
Making a phone call using the Phone Menu ...	46
Using Voice Recognition function.....	47

Using Siri.....	47
Voice Dial Function.....	47
Phone Operation Screen	48
Adjusting the Speech Volume.....	48
Changing the Voice Output.....	48
Muting the Microphone	48
DTMF (Touch-Tone) Function	48
Phone Book Function	48
Searching in the Phone Book.....	48
Synchronizing the Phone Book.....	48
Deleting the Phone Book Entries	49
Setting contacts as Favorites (Shortcut Dialing)	49

Bluetooth Audio

Playback.....	50
Repeat Play.....	50
Shuffle Play.....	50
Connecting a Bluetooth Device.....	50
Disconnecting the Bluetooth Connection.....	50
Switching the connecting Bluetooth Device.....	50

Auxiliary Device (Optional)

Operating Auxiliary Devices (Optional)	51
Setting the Brightness and Contrast.....	51

Camera Operation (Optional)

Rear Camera Operation.....	52
Displaying the Camera Image from the HOME screen	52
Displaying the rear view video while the car is in reverse.....	52
About the Rear Camera Guide.....	52
Front Camera Operation.....	54
Displaying the Camera Image from the HOME screen	54

iDataLink Operation

Access to iDataLink Mode	55
About Parking Sensor screen.....	56
Factory Media Operation.....	56
Factory SiriusXM Operation.....	57

Information

Product Software Update.....	57
About the Supported Formats	57
About MP3/WMA/AAC/FLAC/WAV	57
In Case of Difficulty.....	59
If this Message Appears	60

Specifications.....	61
---------------------	----

Installation and Connections

WARNING	63
CAUTION	63
Precautions	63
Accessory List	64
Installation	64
Caution concerning the installation location.....	64
Mounting the Microphone.....	64
Installation example using the Original Mounting Bracket.....	64
Connections.....	65
If an ACC power supply is not available.....	68
System Example.....	69

LIMITED WARRANTY

Operating Instructions

PRECAUTIONS

IMPORTANT INFORMATION

FCC COMPLIANCE STATEMENT

This equipment has been tested and found to comply with the limits for a Class B digital device, pursuant to part 15 of the FCC Rules. These limits are designed to provide more reasonable protection against harmful interference in a residential installation, and are more stringent than "outdoor" requirements.

Operation is subjected to the following two conditions: (1) This device may not cause harmful interference, and (2) this device must accept any interference received, including interference that may cause undesired operation.

This equipment generates, uses, and can radiate radio frequency energy and, if not installed and used in accordance with the instructions, may cause harmful interference to radio communications. However, there is no guarantee that interference will not occur in a particular installation. If this equipment does cause harmful interference to radio or television reception, which can be determined by turning the equipment off and on, you are encouraged to try to correct the interference by one of the following measures:

- Reorient or relocate the receiving antenna.
- Increase the separation between the equipment and the receiver.
- Connect the equipment into an outlet on a circuit different from that to which the receiver is connected.
- Consult an experienced radio/TV technician.

WARNING

Points to Observe for Safe Usage

- Read this manual carefully before using this system components. They contain instructions on how to use this product in a safe and effective manner. Alpine cannot be responsible for problems resulting from failure to observe the instructions in this manual.
- This manual uses various pictorial displays to show you how to use this product safely and to alert you to potential dangers resulting from improper connections and operation. Following are the meanings of these pictorial displays. It is important to fully understand the meanings of these pictorial displays in order to use this manual and the system properly.

- This product may be used with software applications. Please follow all usage instructions and warnings when using this product at all times. Do not use this product or any software application in a manner which will hinder safe operation of your vehicle.

WARNING

- Operation of the system while driving is dangerous. Users should stop vehicle before operating the software.
- Road conditions and regulations take precedence over information contained on the map display: observe actual traffic restrictions and circumstances while driving.
- This software is designed for use exclusively in the unit. It cannot and may not be used in conjunction with other hardware.

WARNING

This symbol means important instructions. Failure to heed them can result in serious injury or death.

INSTALL THE PRODUCT CORRECTLY SO THAT THE DRIVER CANNOT WATCH TV/VIDEO UNLESS THE VEHICLE IS STOPPED AND THE EMERGENCY BRAKE IS APPLIED.

It is dangerous for the driver to watch TV/Video while driving a vehicle. Installing this product incorrectly enables the driver to watch TV/Video while driving. This may cause a distraction, preventing the driver from looking ahead, thus causing an accident. The driver or other people could be severely injured.

DO NOT WATCH VIDEO WHILE DRIVING.

Watching the video may distract the driver from looking ahead of the vehicle and cause an accident.

DO NOT OPERATE ANY FUNCTION THAT TAKES YOUR ATTENTION AWAY FROM SAFELY DRIVING YOUR VEHICLE.

Any function that requires your prolonged attention should only be performed after coming to a complete stop. Always stop the vehicle in a safe location before performing these functions. Failure to do so may result in an accident.

KEEP THE VOLUME AT A LEVEL WHERE YOU CAN STILL HEAR OUTSIDE NOISES WHILE DRIVING.

Excessive volume levels that obscure sounds such as emergency vehicle sirens or road warning signals (train crossings, etc.) can be dangerous and may result in an accident. LISTENING AT LOUD VOLUME LEVELS IN A CAR MAY ALSO CAUSE HEARING DAMAGE.

MINIMIZE DISPLAY VIEWING WHILE DRIVING.

Viewing the display may distract the driver from looking ahead of the vehicle and cause an accident.

DO NOT DISASSEMBLE OR ALTER.

Doing so may result in an accident, fire or electric shock.

USE ONLY IN CARS WITH A 12 VOLT NEGATIVE GROUND.

(Check with your dealer if you are not sure.) Failure to do so may result in fire, etc.

KEEP SMALL OBJECTS SUCH AS SCREWS OUT OF THE REACH OF CHILDREN.

Swallowing them may result in serious injury. If swallowed, consult a physician immediately.

USE THE CORRECT AMPERE RATING WHEN REPLACING FUSES.

Failure to do so may result in fire or electric shock.

DO NOT BLOCK VENTS OR RADIATOR PANELS.

Doing so may cause heat to build up inside and may result in fire.

USE THIS PRODUCT FOR MOBILE 12V APPLICATIONS.

Use for other than its designed application may result in fire, electric shock or other injury.

MAKE THE CORRECT CONNECTIONS.

Failure to make the proper connections may result in fire or product damage.

BEFORE WIRING, DISCONNECT THE CABLE FROM THE NEGATIVE BATTERY TERMINAL.

Failure to do so may result in electric shock or injury due to electrical shorts.

DO NOT ALLOW CABLES TO BECOME ENTANGLED IN SURROUNDING OBJECTS.

Arrange wiring and cables in compliance with the manual to prevent obstructions when driving. Cables or wiring that obstruct or hang up on places such as the steering wheel, gear lever, brake pedals, etc. can be extremely hazardous.

DO NOT SPLICE INTO ELECTRICAL CABLES.

Never cut away cable insulation to supply power to other equipment. Doing so will exceed the current carrying capacity of the wire and result in fire or electric shock.

DO NOT DAMAGE PIPE OR WIRING WHEN DRILLING HOLES.

When drilling holes in the chassis for installation, take precautions so as not to contact, damage or obstruct pipes, fuel lines, tanks or electrical wiring. Failure to take such precautions may result in fire.

DO NOT USE BOLTS OR NUTS IN THE BRAKE OR STEERING SYSTEMS TO MAKE GROUND CONNECTIONS.

Bolts or nuts used for the brake or steering systems (or any other safety-related system), or tanks should NEVER be used for installations or ground connections. Using such parts could disable control of the vehicle and cause fire etc.

DO NOT INSTALL IN LOCATIONS WHICH MIGHT HINDER VEHICLE OPERATION, SUCH AS THE STEERING WHEEL OR GEARSHIFT.

Doing so may obstruct forward vision or hamper movement etc. and results in serious accident.

 CAUTION

This symbol means important instructions. Failure to heed them can result in injury or material property damage.

HALT USE IMMEDIATELY IF A PROBLEM APPEARS.

Failure to do so may cause personal injury or damage to the product. Return it to your authorized Alpine dealer or the nearest Alpine Service Center for repairing.

HAVE THE WIRING AND INSTALLATION DONE BY EXPERTS.

The wiring and installation of this unit requires special technical skill and experience. To ensure safety, always contact the dealer where you purchased this product to have the work done.

USE SPECIFIED ACCESSORY PARTS AND INSTALL THEM SECURELY.

Be sure to use only the specified accessory parts. Use of other than designated parts may damage this unit internally or may not securely install the unit in place. This may cause parts to become loose resulting in hazards or product failure.

ARRANGE THE WIRING SO IT IS NOT CRIMPED OR PINCHED BY A SHARP METAL EDGE.

Route the cables and wiring away from moving parts (like the seat rails) or sharp or pointed edges. This will prevent crimping and damage to the wiring. If wiring passes through a hole in metal, use a rubber grommet to prevent the wire's insulation from being cut by the metal edge of the hole.

DO NOT INSTALL IN LOCATIONS WITH HIGH MOISTURE OR DUST.

Avoid installing the unit in locations with high incidence of moisture or dust. Moisture or dust that penetrates into this unit may result in product failure.

 NOTICE

Product Cleaning

Use a soft dry cloth for periodic cleaning of the product. For more severe stains, please dampen the cloth with water only. Anything else has the chance of dissolving the paint or damaging the plastic.

Temperature

Be sure the temperature inside the vehicle is between +45°C (+113°F) and 0°C (+32°F) before turning your unit on.

Maintenance

If you have problems, do not attempt to repair the unit yourself. Return it to your Alpine dealer or the nearest Alpine Service Station for servicing.

Protecting the USB connector

- Only an iPhone or USB flash drive can be connected to the USB connector on this unit. Correct performance using other USB products cannot be guaranteed.
- If the USB connector is used, be sure to use only the supplied connector cable with the unit. A USB hub is not supported.
- Depending on the connected USB flash drive, the unit may not function or some functions may not be performed.
- The audio file format that can be played back on the unit is MP3/WMA/AAC/FLAC/WAV.
- Artist/song name, etc., can be displayed. Certain, special characters may not be correctly displayed.

 CAUTION

Alpine accepts no responsibility for lost data, etc., even if data, etc., is lost while using this product.

On Handling USB Flash drive

- This unit can control a memory storage device that supports the USB Mass Storage Class (MSC) protocol. Playable audio file formats are MP3, WMA, AAC, FLAC and WAV.
- USB Flash drive function is not guaranteed. Use USB flash drive according to the terms of agreement. Read the USB flash drive Owner's Manual thoroughly.
- Avoid usage or storage in the following locations: Anywhere in the car exposed to direct sunlight or high temperatures. Anywhere the possibility of high humidity or corrosive substances are present.
- Fix the USB flash drive in a location where driver operation will not be hindered.
- USB Flash drive may not function correctly at high or low temperature.
- Use only certified USB flash drive. Note that even certified USB flash drive, may not function correctly depending on its type or state.
- Depending on the settings of the USB flash drive type, memory state or encoding software, the unit may not play back or display properly.
- USB Flash drive may take time to start playback. If there is a particular file other than audio in the USB flash drive, it may take considerable time before the file is played back or searched.
- The unit can play back "mp3," "wma" or "m4a" file extensions.
- Do not add the above extensions to a file other than audio data. This non-audio data will not be recognized. The resulting playback may contain noise that can damage speakers and/or amplifiers.
- It is recommended to back up important data on a personal computer.
- Do not remove the USB device while playback is in progress. Change SOURCE to something other than USB, then remove the USB device to prevent possible damage to its memory.

- Windows Media are trademarks, or registered trademarks of Microsoft Corporation in the United States and/or other countries.
- Apple, iPhone and Siri are trademarks of Apple Inc., registered in the U.S. and other countries. Apple CarPlay is a trademark of Apple Inc.
- Use of the Made for Apple and Works with Apple badges means that an accessory has been designed to connect specifically to the Apple product(s) identified in the Made for Apple badge and to work specifically with the technology identified in the Works with Apple badge, and has been certified by the developer to meet Apple performance standards. Apple is not responsible for the operation of this device or its compliance with safety and regulatory standards.
- Please note that the use of this accessory with an Apple product may affect wireless performance.
- Use of the Apple CarPlay logo means that a vehicle user interface meets Apple performance standards. Apple is not responsible for the operation of this vehicle or its compliance with safety and regulatory standards. Please note that the use of this product with iPhone may affect wireless performance.
- Sirius, XM and all related marks and logos are trademarks of Sirius XM Radio Inc. All rights reserved.
- HD Radio Technology manufactured under license from iBiquity Digital Corporation. U.S. and Foreign Patents. For patents see <http://dts.com/patents>. HD Radio and the HD, HD Radio, and "ARC" logos are registered trademarks or trademarks of iBiquity Digital Corporation in the United States and/or other countries.
- Google, Android, Google Play and Android Auto are trademarks of Google LLC.
To use Android Auto on your car display, you'll need an Android Auto compatible vehicle or aftermarket stereo, an Android phone running Android 6.0 or higher, and the Android Auto app.
- The terms HDMI and HDMI High-Definition Multimedia Interface, and the HDMI Logo are trademarks or registered trademarks of HDMI Licensing LLC in the United States and other countries.
- The Bluetooth® word mark and logos are registered trademarks owned by the Bluetooth SIG, Inc. and any use of such marks by ALPS ALPINE Co., LTD. is under license. Other trademarks and trade names are those of their respective owners.
- MPEG Layer-3 audio coding technology licensed from Fraunhofer IIS and Thomson. Supply of this product only conveys a license for private, non-commercial use and does not convey a license nor imply any right to use this product in any commercial (i.e. revenue-generation) real time broadcasting (terrestrial, satellite, cable and/or any other media), broadcasting/streaming via internet, intranets and/or other networks or in other electronic content distribution systems, such as pay-audio or audio-on-demand applications. An independent license for such use is required. For details, please visit <http://www.mp3licensing.com>

Made for iPhone X, iPhone 8, iPhone 8 Plus, iPhone 7, iPhone 7 Plus, iPhone SE, iPhone 6s, iPhone 6s Plus, iPhone 6, iPhone 6 Plus, iPhone 5s

Getting Started

Location of Controls

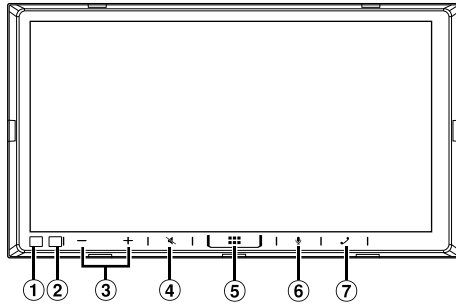

- ① **Dimmer Sensor**
Senses the brightness of the car interior.
- ② **Remote Sensor**
Point the remote control transmitter towards the remote sensor within a range of 2 meters.
- ③ **- / + (DOWN/UP) button**
Adjusts the volume.
- ④ **[Speaker icon with slash] (MUTE) button**
Activates/deactivates MUTE mode.
- ⑤ **[Microphone icon] button**
Activate Siri function or voice recognition mode.
- ⑥ **[Four squares icon] (HOME) button**
Displays the HOME screen.
- ⑦ **[Phone handset icon] (Phone) button**
Displays the Phone Menu screen.
Touch to start a conversation when a call is incoming.

About the button descriptions used in this Owner's Manual

The buttons found on the face of the unit are expressed in bold (e.g. **[Four squares icon] (HOME)**). The buttons found on the touch-screen display are shown in bold within brackets, **[]** (e.g. **[OK]**).

Turning Power On or Off

When the ignition key is turned to ACC or ON, the opening screen will be automatically displayed.

1 Turn the ignition key to the ACC or ON position.

The unit turns on.

- When the unit is used for the first time, the Radio main screen is displayed.
- When turned on, the unit displays the last screen that was displayed before the ignition key was turned off. For example, if the unit is in radio mode when ignition is turned off, it will remain in radio mode when ignition is turned back on.

2 To turn the unit to off, turn the ignition key to the OFF position.

- *The unit is a precision device. Careful handling of the unit should provide you with years of trouble-free operation.*
- *Some of this unit's functions cannot be performed while the vehicle is in motion. Be sure to stop your vehicle in a safe location and apply the parking brake before attempting these operations.*

Adjusting the Volume

Adjust the volume by touching - / +.

Volume decreases/increases continuously by touching and holding - / +.
Volume: 0 to 35

Lowering Volume Quickly

Audio Mute function instantly lowers the volume level to 0.

1 Touch the [Speaker icon with slash] (MUTE) button to activate MUTE mode.

The audio level will be 0.

2 Touch the [Speaker icon with slash] (MUTE) button again to bring the audio back to previous volume level.

Touch Screen Operation

You can operate the unit by using the touch panel display.

- Be sure to touch the onscreen button lightly with the pad of your finger to avoid scratching the display.

Touch operation

Touch a button or list item on the screen lightly.



- If you touch a button and there is no reaction, remove your finger.
- Onscreen buttons that cannot be operated are dimmed.

Swipe operation

Move your finger lightly with a swipe.



Drag & Drop operation

Touch and hold the desired item, then drag it to its new location by moving your finger, then release your finger to place the item.



- Except for USB Photo mode, it is not possible to narrow the screen with two fingers (pinch in) or spread the screen (pinch out).

Switching Sources

1 Touch the (HOME) button.

The HOME screen is displayed.



2 Touch a widget of your desired source.

- In the HOME screen, you can change the widget location on the screen. For details, see "About the HOME Screen" (page 12).

Selecting an Item in a List

To scroll through a list, perform the following operations.

Touch the screen and slide your finger up and down.

The screen will scroll along with your finger movement.

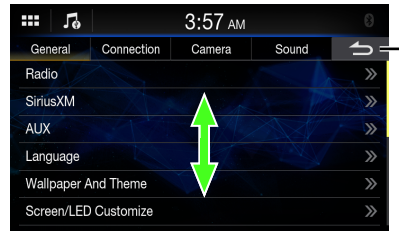

Returns to the previous screen. Depending on the function, this button may cancel the operations performed on the screen.

- After touching the screen, move your finger away from the screen before dragging and that item will be selected.

About the HOME Screen

In the HOME screen, select a widget to perform various settings and operations of the function.

Touch the (HOME) button.

The HOME screen is displayed.

- You can also display the HOME screen by touching  at the top of the screen.

■ HOME screen example

HOME screen navigation

Swipe the HOME screen horizontally with your finger to change the page. Up to 3 pages exist.



Widget
Touch to activate the function.

- After selecting [Audio] widget, it is possible to switch the mode to USB Audio mode, iPod mode for iPhone or Bluetooth Audio mode.

Editing HOME screen

You cannot operate the Widgets editing screen while driving.

Your vehicle must be parked with the ignition key in the ACC or ON position. For details, see "To display the Setup Menu screen" in "Setup Operation" (page 13).

In the Widgets editing screen, you can change the audio source order or set the display/hide settings.

1 Touch and hold the HOME screen for at least a second.

The widgets editing screen is displayed.



Additional candidate widgets

- The source icon displayed in the Widgets editing screen is displayed only when usable setup and conditions of each Audio source are fulfilled. For details on setup and conditions of each audio source, see "Switching Sources" (page 11).

■ Adding a widget

Drag and drop a widget from the additional candidate widgets area to the desired position of the HOME screen image area.

- To show more candidate widgets, swipe horizontally.
- There are 3 sizes of widgets.

■ Changing the order of widget

Drag and drop the widget to the desired location.

■ Deleting a widget from the HOME screen

Drag and drop a widget from the HOME screen image area to .

-  is displayed while touching a widget.

2 Touch the (HOME) button.

The HOME screen is displayed.

About the Indicator Display

The Indicator Bar at the top of the screen displays various types of information, like the current time.



- ① Recalls the HOME screen.
- ② Displays the currently playing audio source. Touch to return to the Audio source screen.
- ③ Indicates the current time. You can switch between the 12 hour display and 24 hour display options (page 18).
- ④ Displays the SiriusXM signal strength when connecting to SiriusXM Tuner. (If SiriusXM Tuner is not connected, it is not displayed.)
- ⑤ Lights up when connected to a Bluetooth compatible device. (Does not display when connection is set to OFF.)

Setup

Setup Operation

To display the Setup Menu screen:

Your vehicle must be parked with the ignition key in the ACC or ON position. To do this, follow the procedures below.

- 1 Bring your vehicle to a complete stop at a safe location. Engage the parking brake.
- 2 Release the parking brake. (For safety, release the parking brake while depressing the foot brake pedal).
- 3 Engage the parking brake again.

- For automatic transmission vehicles, place the transmission lever in the Park position.

Now, the locking system for the Setup operation has been released. Engaging the parking brake can reactivate the Setup Menu, as long as the car's ignition has not been turned off. It is not necessary to repeat the above procedure (1 through 3).

Each time the ignition is turned OFF, perform the above procedure.

1 Touch the (HOME) button.

The HOME screen is displayed.



[Settings] button

2 Touch [Settings].

The Settings menu screen is displayed.

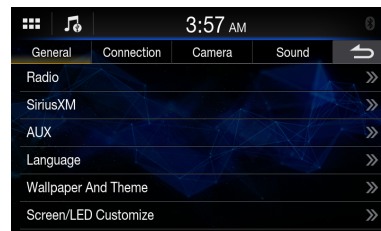

3 Touch the required setting genre on the upper part of the Settings menu screen, and then touch the setting item.

Setting genres:

General: See "General Setup" (page 14).

Connection: See "Connection (Bluetooth) Setup" (page 20).

Camera: See "Camera Setup" (page 21).

Sound: See "Sound Setup" (page 24).

General Setup

[General] is selected on the Settings menu screen.

■ General Setup Menu screen

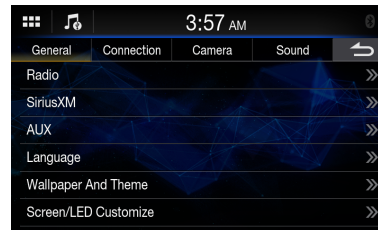

Setting items:

Radio (page 14)

SiriusXM (page 15)

AUX (page 16)

Language (page 16)

Wallpaper And Theme (page 17)

Screen/LED Customize (page 17)

Date/Clock (page 18)

Display Off (page 18)

About (page 18)

Installation (page 19)

Steering Wheel Position (page 19)

Mute While Backing Up (page 17)

iDatalink (page 19)

Radio Setup

[Radio] is selected on the General Setup Menu screen.

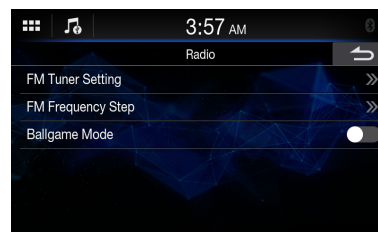

Setting the TUNER (FM) Tone Quality (Tuner Condition)

This unit can set your preferred tone quality for FM radio source.

Setting item:

FM Tuner Setting

Setting contents:

Normal (Initial setting) / HiFi / Stable

Normal:	Standard setting
HiFi:	High-quality setting
Stable:	Control noise

- Noise may be more noticeable when [HiFi] is set, depending on the reception status. In this case, the [Normal] setting is recommended.

Setting the TUNER (FM) Frequency Step

During manual tuning, you can select the frequency step for FM analog radio station searching.

Setting item:

FM Frequency Step

Setting contents:

100 kHz / 200 kHz (Initial setting)

Setting the Ballgame Mode

To receive live broadcast with HD Radio, set [Ballgame Mode] to [On].

Setting item:

Ballgame Mode

Touch [] (Off) or [] (On) of "Ballgame Mode".

SiriusXM Setup

[Sirius XM] is selected on the General Setup Menu screen.

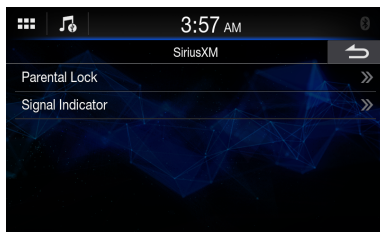

Setting the Parental Lock

You can lock out channels with passcode protection. Channels that are locked cannot be accessed without entering the passcode. You can unlock a channel or change the passcode using this menu option.

Setting item:

Parental Lock

1 Touch [Parental Lock].

A passcode input screen is displayed.

2 Touch the numeric keypad to input a 4-digit passcode.

The initial default 4-digit passcode is set to 0000.

After entering the digit, it is displayed as "●".

- Touch [] to delete an entered number.

3 Touch [OK].

Setting the Lock status of individual channels

4 Touch [Locked Channels].

The channels list screen is displayed.

5 Touch [] (Off) or [] (On) of the channels list to set the Parent Lock.

Clearing the Lock of ALL the locked Channels

4 Touch [Clear All Locked Channels].

5 Touch [Yes] to clear the lock of all the locked channels.

Touch [No] to cancel.

Changing the Lock Passcode

4 Touch [Edit Code].

The numeric keypad screen is displayed.

5 Use the keypad to enter the current (old) 4-digit passcode, and then touch [OK].

The initial passcode is set to "0000".

- Touch [] to delete an entered number.

6 Touch [OK] to confirm the entry.

7 Now use the keypad to enter the new 4-digit passcode.

8 Touch [OK].

9 Use the keypad to enter the new 4-digit passcode a second time to verify it, and then touch [OK].

- Remember to keep a note of the passcode in a safe place in case you forget the code.

Signal Strength Information

While listening to a SiriusXM Channel, the Signal strength of the current channel will be displayed.

Setting item:
Signal Indicator

This menu item displays the SiriusXM signal strength as Excellent, Good, Weak or No Signal.

- If the Signal indicator reports Weak or No Signal and your vehicle is parked outside with no obstructions to the southern sky, then your SiriusXM antenna may not be properly installed or may have become damaged.

AUX Setup

[AUX] is selected on the General Setup Menu screen.



■ Usable 3-pole mini AV plug

The unit accepts the following 3-pole mini AV plug pin-out:

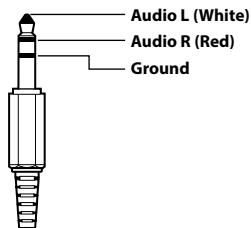

- Please check pin-out carefully before use of this product. Depending on the cable, there may be no sound.

Setting the AUX Select

You can set up the connected AUX device.

Setting item:
AUX Select

Setting contents:
AUX (Initial setting) / Factory Media + Drive Recorder

- When "AUX" is set, audio will not be output from Factory Media or Factory SiriusXM mode.
- When "Factory Media + Drive Recorder" is set, AUX In Audio will be used by the Factory Media and Factory SiriusXM mode. Only AUX In Video will be output in the AUX mode. Audio will not be output.

Setting the Input Signal

The video input signal type can be chosen.

Setting item:
Input Signal
Setting contents:
NTSC (Initial setting) / PAL

Setting the Display Mode

You can switch the Display Mode of the video file to be played.

Setting item:
Display Mode
Setting contents:
Full (Initial setting) / 4.3

Language Setup

[Language] is selected on the General Setup Menu screen. The Setup menu, feedback information, etc. for this unit can be changed to appear in the selected language.

Setting item:
Language
Setting contents:
English (Initial setting) / Deutsch / Français / Español / Italiano / Português / Polski / Nederlands / Dansk / Suomi / Norsk / Svenska / Slovenčina / Čeština / Magyar / Ελληνικά / Türkçe / русский / العربية / العربية / Bahasa Indonesia / Bahasa Melayu / Tiếng Việt / 中文 / 日本語

- The currently selected language is displayed.

Wallpaper Setup

[Wallpaper And Theme] is selected on the General Setup Menu screen.

You can change the wallpaper of the display screen from 4 different colored default images or your image.

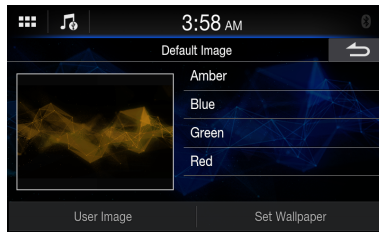

Setting a Wallpaper using a default image

Setting contents:

Amber / Blue / Green / Red

Touch the desired image, and then touch [Set Wallpaper].

Setting a Wallpaper using your image

1 Touch [User Image].

The image selecting screen is displayed.

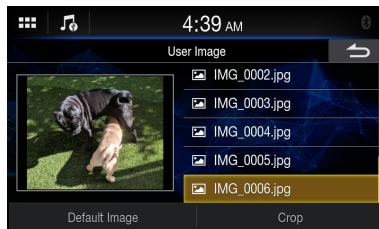

2 Select an image stored on the connected USB Flash drive.

The selected image thumbnail is displayed.

If not using an image as a wallpaper, touch [Default Image] to return to the previous screen without selecting.

3 Touch [Crop].

4 Touch the area to be trimmed for a wallpaper.

If the image is 800 x 480 pixel, this step is not necessary.

5 Touch [Set Theme] to change the theme color.

6 Touch the desired color.

7 Touch [Set Wallpaper].

Screen/LED Customize Setup

[Screen/LED Customize] is selected on the General Setup Menu screen.

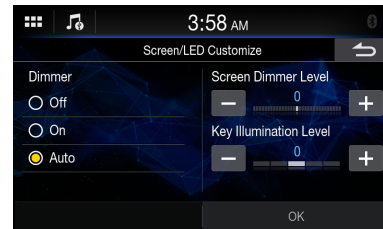

Setting item:

Dimmer / Screen Dimmer Level / Key Illumination Level

Setting the Brightness of the Backlighting (Dimmer)

Backlighting is provided by LEDs light built into the liquid crystal panel. The illumination control adjusts the brightness of the backlighting based on the car ambient lighting for easier viewing.

Setting item:

Dimmer

Setting contents:

Off / On / Auto (Initial setting)

Off: Deactivate Auto Dimmer mode to keep the background illumination of the monitor bright.

On: Keep the background illumination of the monitor dark.

Auto: Adjust the brightness of the background illumination of the monitor automatically to the brightness of the car interior.

- When [On] is set, the setting is also applied for the button lighting in "Adjusting the Dimmer of Button Lighting at Night" (page 17) and "Adjusting the Minimum Level of Backlight" (page 18).

Adjusting the Minimum Level of Backlight

You can adjust the brightness of the backlight. This function could be used, for instance, to change the screen brightness while traveling at night.

Setting item:

Screen Dimmer Level

Setting contents:

-15 to 15 (Initial setting: 0)

- This setting is only available when "Dimmer" is set to [On] or [Auto].

Adjusting the Dimmer of Button Lighting at Night

You can adjust the brightness of the button lighting at night with the dimmer.

Setting item:

Key Illumination Level

Setting level:

-2 to 2 (Initial setting: 0)

- This setting is only available when “Dimmer” is set to [On] or [Auto].

Date/Clock Setup

[Date/Clock] is selected on the General Setup Menu screen. You can set the display type of the Date/Clock adjustment and the clock display to 12-hours or 24-hours, depending on your preference.

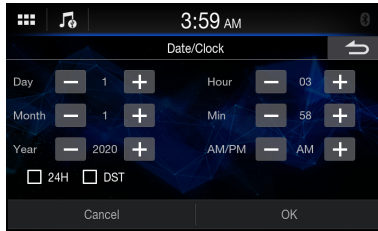

Setting item:

Date/Clock

Touch [+] or [-] to adjust the day, month, year, hour, minute and AM/PM.

- To change to 24-hour, set “24H” to [On] (☑).
- To set the daylight saving time (Summer Time mode), set “DST” to [On] (☑).

Display Off Setting

When [Display Off] is selected on the General Setup Menu screen, the display is turned Off.

Setting item:

Display Off

- To cancel Display Off mode, touch the screen or any button.
- Display Off mode is canceled when the power or ACC is turned off.
- When the gear lever is shifted to the reverse (R) position and the rear camera is connected, the rear camera image is displayed.
- When a call is received on a Bluetooth-connected phone, the incoming call screen is displayed.
- You can also activate Display Off mode directly by touching the [Display Off] widget on the HOME screen.

About iLX-407

[About] is selected on the General Setup Menu screen. [About] enables you to check the Serial No., Firmware Version, Model Name, and to initialize various settings.

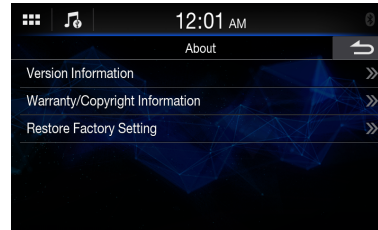

Displaying the Product Information

You can view the version information of this product. Make note of this information and refer to it whenever you contact Alpine Tech Support or an Alpine-authorized dealer.

Setting item:

Version Information

Setting contents:

Serial No. / SYSTEM version / Firmware Version

Displaying Warranty/Copyright Information

Setting item:

Warranty/Copyright Information

Setting contents:

Open source licenses / Notice

Initializing the System

You can initialize all data, to restore the factory settings. Remove the USB flash drive, etc. from the system before operation.

1 Touch [Restore Factory Setting].

2 After the confirmation message appears, touch [Yes].

The confirmation screen appears.

3 Touch [Confirm].

The system starts initialization.

- Do not turn on/off the power, change the ignition key position or remove the screen panel until system restart is completed.

Installation Setup

[**Installation**] is selected on the General Setup Menu screen.

Vehicle Setup enables you to check the connection status of Reverse Lead/Parking Brake Lead.

When selecting the item, the Installation check screen is displayed.

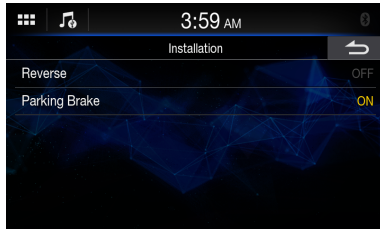

Setting item:

Installation

Setting contents:

Reverse / Parking Brake

Steering Wheel Position Setting

[**Steering Wheel Position**] is selected on the General Setup Menu screen.

Set this item when Apple CarPlay is used/Android smartphone which installed Android Auto App is connected.

This setting influences Apple CarPlay/Android Auto mode.

Setting item:

Steering Wheel Position

Setting contents:

Left (Initial setting) / Right



Mute Setting

[**Mute While Backing Up**] is selected on the General Setup Menu screen.

You can set the sound will be muted automatically when the gear lever is moved to the reverse (R) position.

Setting item:

Mute While Backing Up

Touch [] (Off) or [] (On) of "Mute While Backing Up".

iDataLink Setting

[**iDataLink**] is selected on the General Setup Menu screen.

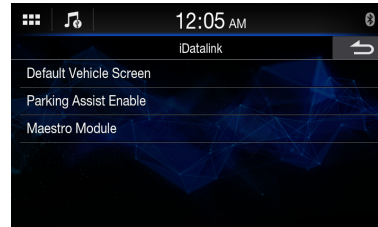

Setting the Default Vehicle Screen

You can set the Default Vehicle Screen displayed in iDataLink mode.

Setting item:

Default Vehicle Screen

Setting contents:

Gauges / Climate / Parking Assist / Vehicle Info. / Last Mode (Initial setting)

- Depending on the car, some setting contents or this setting item may not be displayed.

Setting the Parking Assist Enable

You can set up the camera for Parking Assist.

Setting item:

Parking Assist Enable

Setting contents:

Off (Initial setting) / Primary Camera / Secondary Camera

Setting the Maestro Module

You can change the setting of the connected iDataLink module.

Setting item:

Maestro Module

- This setting is only available when the iDataLink Maestro® module (sold separately) is connected.
- Depending on the iDataLink module, the setting contents may differ.

Connection (Bluetooth) Setup

[Connection] is selected on the Setup menu screen.

■ Connection Setup Menu screen

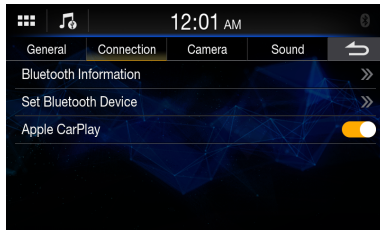

Setting items:

- Bluetooth Information (page 20)
- Set Bluetooth Device (page 20)
- Apple CarPlay (page 21)

Displaying Bluetooth Information

[Bluetooth Information] is selected on the Connection Setup Menu screen. You can display the Bluetooth device name and device address of this unit.

Setting item:

- Bluetooth Information

Pairing the Bluetooth Device

[Set Bluetooth Device] is selected on the Connection Setup Menu screen. Search for Bluetooth compatible devices.

Setting item:

- Set Bluetooth Device

1 Touch [Set Bluetooth Device].

The Bluetooth Setup screen is displayed.

- You can also display the Bluetooth Setup screen directly by touching the [Bluetooth Settings] widget on the HOME screen.

2 Select this unit on the Bluetooth device.

A message about the device to be registered is displayed.

3 Touch [Yes].

The Bluetooth device is connected. If you connecting to a smartphone, a message to download the phonebook is displayed.

4 Touch [Audio] or/and [Hands-free] of the device you want to connect from the list.

Audio: Device is used as an Audio device.
Hands-free: Device is used as a Hands Free Device.

- You can register up to 5 Bluetooth compatible mobile phones.
- You can connect 1 Bluetooth Device to each of Bluetooth Audio mode and Hands-free mode.
- The Bluetooth registration process differs depending on the device version and SSP (Simple Secure Pairing). If a 4 or 6 character Passcode appears on this system, enter the Passcode on the Bluetooth device.
- If a 6 character Passkey appears on this device, make sure the same passkey is displayed on the Bluetooth compatible device and touch [OK].
- If all 5 devices have been registered, you cannot register a 6th device. To register another device, you need to delete one of the other 5 devices first.

Setting the Bluetooth Device

Select one of 5 paired Bluetooth compatible devices that you previously registered.

Touch [Audio] or [Hands-free] of the device you want to connect from the Paired Device list.

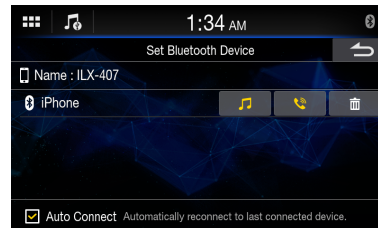

- You can also change the connected device by touching the device name.

Deleting a Bluetooth Device from the list

You can delete the information of a previously connected Bluetooth compatible device.

1 Touch [Delete] of the Bluetooth compatible device to delete from the Paired Device list.

2 Touch [Yes].

- Touching [No] will cancel the setting.

Setting the Auto Connection

You can connect the last connected device automatically.

Set "Auto Connect" to [On] (☑).

Apple CarPlay Setup

[**Apple CarPlay**] is selected on the Connection Setup Menu screen.
To use the Apple CarPlay (page 31), set "Apple CarPlay" to [On].

Setting item:
Apple CarPlay

Touch [] (Off) or [] (On) of "Apple CarPlay".

Camera Setup

[**Camera**] is selected on the Setup Menu screen.
You can set up items related to the Camera.

■ Camera Setup Menu screen

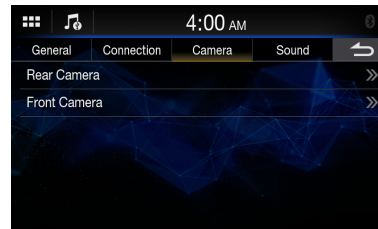

Setting items:

Rear Camera (page 21)
Front Camera (page 23)

Rear Camera Setup

[**Rear Camera**] is selected on the Camera Setup Menu screen.

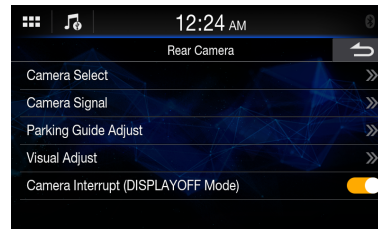

Camera Input Setting

[**Camera Select**] is selected on the Camera Setup Menu screen.

Setting item:

Camera Select

Setting contents:

Off (Initial setting) / Rear

Off: No camera is connected.
Rear: Rear camera is connected.

Camera Signal Input Setting

[**Camera Signal**] is selected on the Camera Setup Menu screen.

When the camera is connected, the video input signal type can be chosen.

Further setting item:

Camera Signal

Setting contents:

NTSC (Initial setting)/PAL

Rear Camera Guide Settings

[**Parking Guide Adjust**] is selected on the Camera Setup Menu screen. You can adjust the camera guide position.

Setting item:

Parking Guide Adjust

1 Touch [Parking Guide Adjust] on the Camera Setup menu screen.

The camera guide adjustment screen is displayed.

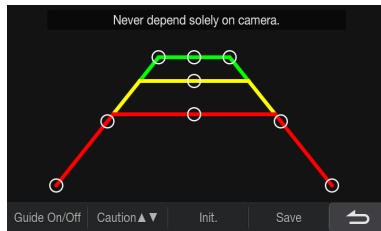

2 Slide [○] to adjust.

3 After the adjustment is completed, touch [Save].

- Touching [**Init.**] clears adjustments and returns to the setting before guide line alteration.

4 Touch [↩] to complete the adjustment and return to the previous screen.

Turning the Rear Camera Guide On/Off

When displaying the rear camera view on the screen, you can set to hide or show the camera guide.

Setting item:

Guide On/Off

Setting contents:

Off / On

Adjusting the Caution Position

You can move the position of the displaying message on the screen.

Setting item:

Caution ▲▼

Camera Picture Quality Setup

[**Visual Adjust**] is selected on the Camera Setup Menu screen.

You can adjust the picture quality for the primary and secondary cameras.

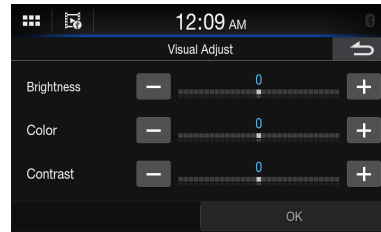

Setting item:

Visual Adjust

Adjusting Brightness

Setting item:

Brightness

Setting contents:

-15 to 15 (Initial setting: 0)

- You can adjust the brightness between MIN (-15) and MAX (+15).

Adjusting Color of Display

Setting item:

Color

Setting contents:

-15 to 15 (Initial setting: 0)

- You can adjust the color between MIN (-15) and MAX (+15).

Adjusting Display Contrast

Setting item:

Contrast

Setting contents:

-15 to 15 (Initial setting: 0)

- You can adjust the contrast between MIN (-15) and MAX (+15).

Camera Interrupt Setting (DISPLAY OFF Mode)

You can set whether to display the rear camera image when the gear lever is moved to the reverse (R) position while the unit is turned off.

Setting item:

Camera Interrupt (DISPLAYOFF Mode)

Touch [○] (Off) or [●] (On) of "Camera Interrupt (DISPLAYOFF Mode)".

Front Camera Setup

[**FrontCamera**] is selected on the Camera Setup Menu screen.



Camera Input Setting

[**Camera Select**] is selected on the Camera Setup Menu screen.

Setting item:

Camera Select

Setting contents:

Off (Initial setting) / Front

Off: No camera is connected.

Front: Front camera is connected.

Camera Signal Input Setting

[**Camera Signal**] is selected on the Camera Setup Menu screen.

When the camera is connected, the video input signal type can be chosen.

Further setting item:

Camera Signal

Setting contents:

NTSC (Initial setting)/PAL

Camera Picture Quality Setup

[**Visual Adjust**] is selected on the Camera Setup Menu screen.

You can adjust the picture quality for the primary and secondary cameras.

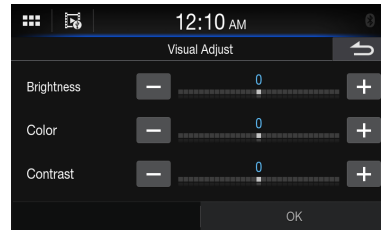

Setting item:

Visual Adjust

Adjusting Brightness

Setting item:

Brightness

Setting contents:

-15 to 15 (Initial setting: 0)

- You can adjust the brightness between MIN (-15) and MAX (+15).

Adjusting Color of Display

Setting item:

Color

Setting contents:

-15 to 15 (Initial setting: 0)

- You can adjust the color between MIN (-15) and MAX (+15).

Adjusting Display Contrast

Setting item:

Contrast

Setting contents:

-15 to 15 (Initial setting: 0)

- You can adjust the contrast between MIN (-15) and MAX (+15).

Sound Setup

[**Sound**] is selected on the Settings menu screen. You can set up items related to the sound quality.

■ Sound Setup Menu screen

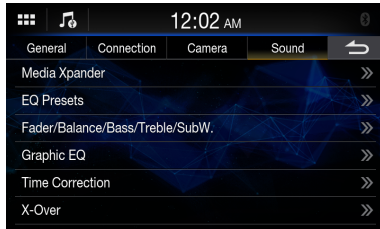

Setting items:

- Media Xpander (page 24)
- EQ Presets (page 24)
- Fader/Balance/Bass/Treble/SubW. (page 24)
- Graphic EQ (page 25)
- Time Correction (page 26)
- X-Over (page 26)
- Volume (page 27)
- Subwoofer (page 27)
- Rear Speaker (page 28)
- Defeat (page 28)

Setting the Media Xpander (MX)

[**Media Xpander**] is selected on the Sound Setup Menu screen. Media Xpander (MX) makes vocals or instruments sound distinct regardless of the music source. The SiriusXM, USB Flash drive and iPod, will be able to reproduce the music clearly even in cars with a lot of road noise.

Setting item:

Media Xpander

- 1 Touch the check box of [ALL MX].
- 2 Touch any of [Off] [Level 1] [Level 2] [Level 3].

- To cancel MX mode, set [Off] in step 1.
- MP3/WMA/AAC can have its own MX setting.
- When the Defeat setting is [On], you cannot perform the set up.
- The MX setting can be performed only when a source is currently selected.

Equalizer Settings

[**EQ Presets**] is selected on the Sound Setup Menu screen. 10 typical equalizer settings are preset at the factory for a variety of musical source material.



Setting item:

EQ Presets

Setting contents:

FLAT (Initial setting) / POP / ROCK / CLASSICAL / JAZZ / ELECTRONIC / HIP HOP / EASY LISTENING / COUNTRY / NEWS

- Only one type can be set to On.
- When Equalizer Presets is set, the linked Graphic EQ settings are also changed. We recommend storing Graphic EQ settings in a Preset in advance.
- The Equalizer Presets setting can be configured when Defeat is Off.

Fader/Balance/Bass/Treble/Subwoofer Settings

[**Fader/Balance/Bass/Treble/SubW.**] is selected on the Sound Setup Menu screen.

Setting item:

Fader/Balance/Bass/Treble/SubW.

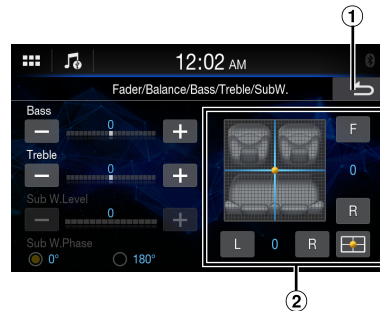

- ① Cancel
Sound setup finishes.
- ② Fader/Balance Image area

Setting the Fader/Balance

Touch the desired point within the image area, or touch [F] (Front), [R] (Rear), [L] (Left) or [R] (Right).

Fader:

15 (F) to 15 (R)

Balance:

15 (L) to 15 (R)

- To reset to the initial setting (F/R: 0, L/R: 0), touch .

Adjusting the Bass/Treble

Touch [+] or [-] for each item to be adjusted.

Setting item:

Bass, Treble

Setting contents:

-10 to 10 (Initial setting: 0)

Setting the Subwoofer

Adjusting the Subwoofer Level

Setting item:

Sub W.Level

Setting contents:

0 (Initial setting) to 15

- This setting is only available when "Subwoofer" is set to [On] (page 27).

Setting the Subwoofer Phase

The subwoofer output phase is toggled Subwoofer Normal (0°) or Subwoofer Reverse (180°).

Setting item:

Sub W.Phase

Setting contents:

0° (Initial setting), 180°

- This setting is only available when "Subwoofer" is set to [On] (page 27).

Graphic Equalizer Curve Settings (Graphic EQ)

[Graphic EQ] is selected on the Sound Setup Menu screen. You can modify the Equalizer settings to create a response curve more appealing to your personal taste.

Setting item:

Graphic EQ

Setting contents:

-7 to 7

- This setting is only available when "Defeat" is set to [On] (page 28).

- 1 Touch [Graphic EQ] on the Sound Setup menu screen.

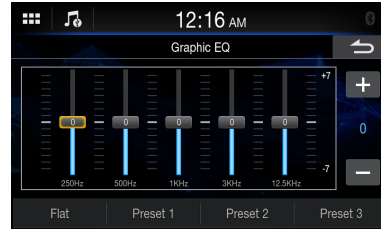

- 2 Touch the band to be adjusted.
- 3 Touch [+] or [-] to adjust the level of the band.
- 4 To adjust another band, repeat step 2 to 3, and adjust all bands.
- 5 To store the adjusted setting value, touch and hold [Preset 1], [Preset 2], or [Preset 3] for at least 2 seconds.

- Settings exceeding the frequency of adjacent bands are not available.
- While adjusting the Graphic EQ, you should consider the frequency response of the connected speakers.
- When the Graphic EQ is adjusted, the Equalizer Presets are overridden.
- When Equalizer Presets is set, the linked Graphic EQ settings are also changed. We recommend storing Graphic EQ settings in a Preset in advance.
- Touch [Flat] to initialize all values.

Calling the Graphic EQ adjusted value

Touch [Preset 1], [Preset 2], or [Preset 3].

The setting stored in the Preset will be recalled.

Time Correction Settings

[Time Correction] is selected on the Sound Setup Menu screen.

Before performing the following procedures, see "About Time Correction" (page 29).



Correction mode

Setting item:

Time Correction

- 1 Touch [Time Correction] on the Sound Setup menu screen.
- 2 Touch the Correction mode button, and then select [ms], [cm] or [inch].
- 3 Touch [–] or [+] for each speaker to adjust the time or distance.
0.0 msec to 9.9 msec (0.1 msec/step)
0.0 cm (0.0 inch) to 336.6 cm (132.56 inch) (3.4 cm/step)
All speaker setting values are adjustable in the range of 20 ms or 680 cm.
- 4 To store the adjusted setting value, touch and hold [Preset 1], [Preset 2], or [Preset 3] for at least 2 seconds.

- Touch [Flat] to set all values to 0.0.
- If the Rear Speaker setting is Off, the Rear Speaker setting cannot be edited (page 28).
- If the Subwoofer setting is Off, the Subwoofer setting cannot be edited (page 27).

Calling the Time Correction Value

Calling the pre-set time correction value.

Touch [Preset 1], [Preset 2], or [Preset 3] on the time correction screen.

The setting stored in the Preset will be recalled.

Crossover Settings (X-Over)

[X-Over] is selected on the Sound Setup Menu screen.

Before performing the following procedures, see "About the Crossover" (page 28).

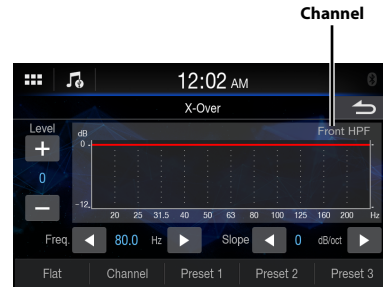

Setting item:

X-Over

- 1 Touch [X-Over] on the Sound Setup menu screen.
- 2 Touch [Channel], and then select [Front HPF], [Rear HPF] or [SubW.LPF].
- 3 Adjust the crossover to your preference.

Selecting the Cut-Off Frequency

Touch [◀] or [▶] of "Freq." (Frequency), and then select the cut-off frequency.

Setting contents:

20.0 / 25.0 / 31.5 / 40.0 / 50.0 / 63.0 / 80.0 (Initial setting)
/ 100.0 / 125.0 / 160.0 / 200.0 Hz

Adjusting the Slope

Touch [◀] or [▶] of "Slope", and then adjust the HPF or LPF slope.

Setting contents:

0 (Initial setting) / 6 / 12 / 18 / 24 dB/oct.

Adjusting the Level

Touch [–] or [+] of "Level", and then adjust the HPF or LPF level.

Setting contents:

-12 to 0 dB (Initial setting: 0)

- 4 Repeat steps 2 to 3 to make adjustment to the other channels.
- 5 To store the adjusted setting value, touch and hold [Preset 1], [Preset 2], or [Preset 3] for at least 2 seconds.

- Touch [Flat] to initialize all values.
- If the Rear Speaker setting is Off, the Rear Speaker setting cannot be edited (page 28).

- If the Subwoofer setting is Off, the Subwoofer setting cannot be edited (page 27).
- While adjusting the X-Over you should consider the frequency response of the connected speakers.

Calling the X-Over adjusted value

Touch [Preset 1], [Preset 2], or [Preset 3].

The setting stored in the Preset will be recalled.

Volume Setup

[Volume] is selected on the Sound Setup menu screen.

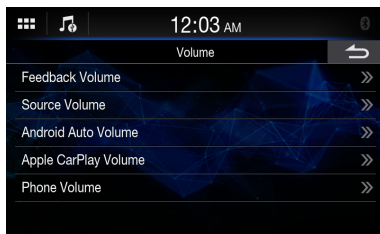

Setting items:

- Feedback Volume (page 27)
- Source Volume (page 27)
- Android Auto™ Volume (page 27)
- Apple CarPlay Volume (page 27)
- Phone Volume (page 27)

- Settable source differs depending on the connected device and settings.

Adjusting the Key Sound

You can change the volume of the sound heard when a button is touched.

Setting item:

Feedback Volume

Setting contents:

0 to 7 (Initial setting: 4)

Adjusting the Source Volume

Touch [Source Volume] on the Volume Setup menu screen.

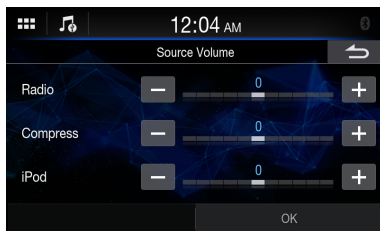

Setting item:

Radio / Compress* / iPod / Bluetooth Audio / Sirius XM / HDMI / AUX / Factory Audio

Setting contents:

-5 to +5 (Initial setting: 0)

- * Compressed Media is the music data in a USB flash drive (MP3/WMA/AAC/FLAC/WAV).

Setting the Volume for Android Auto™

When an Android Smartphone is connected, touch [Android Auto Volume] to set the volume for Android Auto mode.

Setting item:

Entertainment / Notification

Setting contents:

Entertainment: -5 to +5 (Initial setting: 0)
Notification: 0 to 35 (Initial setting: 10)

Setting the Volume for Apple CarPlay

When an iPhone 5s or later is connected, touch [Apple CarPlay Volume] to set the volume for Apple CarPlay mode.

Setting item:

Entertainment / Notification / Ringtone / Phone Calls

Setting contents:

Entertainment: -5 to +5 (Initial setting: 0)
Notification: 0 to 35 (Initial setting: 10)
Ringtone: 0 to 11 (Initial setting: 5)
Phone Calls: 0 to 11 (Initial setting: 5)

Adjusting the Volume for Phone

You can adjust the speaker volume and receive volume, during the call.

Setting item:

Speaker Volume / Mic Level / Ringtone Volume

Setting contents:

Speaker Volume: 0 to 11 (Initial setting: 5)
Mic Level: 1 to 11 (Initial setting: 7)
Ringtone Volume: 0 to 11 (Initial setting: 5)

Turning Subwoofer ON/OFF

If an optional subwoofer is connected to the unit, make the following setting.

Setting item:

Subwoofer

Touch [] (Off) or [] (On) of "Subwoofer".

Rear Speaker Setting

You can set the rear speaker output to Off.

Setting item:
Rear Speaker

Touch [] (Off) or [] (On) of "Rear Speaker".

Defeat Setting

If Defeat is On, the Equalizer setting are turned Off. This disables any settings made for these functions.

Setting item:
Defeat

Touch [] (Off) or [] (On) of "Defeat".

About the Crossover

Crossover (X-Over):

This unit is equipped with an active crossover. The crossover limits the frequencies delivered to the outputs. Each channel is controlled independently. Thus, each speaker pair can be driven by the frequencies for which they have been optimally designed.

The crossover adjusts the HPF (high pass filter) or LPF (low pass filter) of each band, and also the slope (how fast the filter rolls off the highs or lows).

Adjustments should be made according to the reproduction characteristics of the speakers. Depending on the speakers, a passive network may not be necessary. If you are unsure about this point, please consult your authorized Alpine dealer.

	Cut-off frequency (1/3 octave steps)		Slope		Level
	HPF	LPF	HPF	LPF	
Subwoofer (LPF)	----	20 Hz - 200 Hz	----	0, 6, 12, 18, 24 dB/oct.	0 to -12 dB
Rear speaker (HPF)	20 Hz - 200 Hz	----	0, 6, 12, 18, 24 dB/oct.	----	0 to -12 dB
Front speaker (HPF)	20 Hz - 200 Hz	----	0, 6, 12, 18, 24 dB/oct.	----	0 to -12 dB

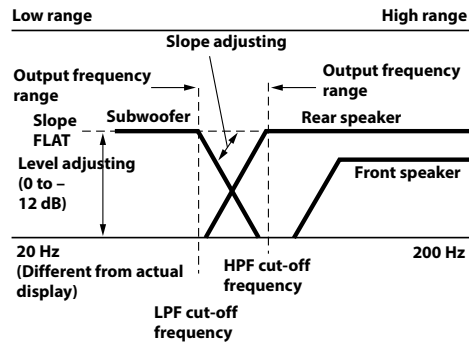

- *HPF (high pass filter): Cuts the lower frequencies and allows the higher frequencies to pass.*
- *LPF (low pass filter): Cuts the higher frequencies and allows the lower frequencies to pass.*
- *Slope: The level change (in dB) for a frequency change of one octave.*
- *The higher the slope value, the steeper the slope becomes.*
- *Adjust the slope to FLAT to bypass the HP or LP filters.*
- *Do not use a tweeter without the HPF on or set to a low frequency, as it may cause damage to the speaker due to the low frequency content.*

- Adjustment should be made according to the recommended crossover frequency of the connected speakers. Determine the recommended crossover frequency of the speakers. Adjusting to a frequency range outside that recommended may cause damage to the speakers.
For the recommended crossover frequencies of Alpine speakers, refer to the respective Owner's Manual.
We are not responsible for damage or malfunction of speakers caused by using the crossover outside the recommended value.

About Time Correction

The distance between the listener and the speakers in a car vary widely due to the complex speaker placement. This difference in the distances from the speakers to the listener creates a shift in the sounds image and frequency characteristics. This is caused by the time delay between the sound reaching the listener's right versus the left ear. To correct this, this unit is able to delay the audio signal to the speakers closest to the listener. This effectively creates a perception of increased distance for those speakers. The listener can be placed at an equal distance between the left and right speakers for optimum staging. The adjustment will be made for each speaker in 3.4 cm steps.

Example 1. Listening Position: Front Left Seat

Adjust the time correction level of the front left speaker to a high value and the rear right to zero or a low value.

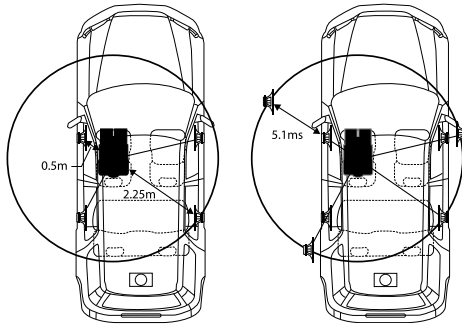

The sound is not balanced because the distance between the listening position and the various speakers is different. The difference in distance between the front left speaker and the rear right speaker is 1.75 m (68-7/8"). Here we calculate the time correction value for the front left speaker in the diagram on the above.

Conditions:

Farthest Speaker – listening position : 2.25 m (88-9/16")

Front left speaker – listening position : 0.5 m (19-11/16")

Calculation: $L = 2.25 \text{ m} - 0.5 \text{ m} = 1.75 \text{ m} (68-7/8")$

Time correction = $1.75 \div 343 \times 1,000 = 5.1 \text{ (ms)}$

* Speed of sound: 343 m/s (765 mph) at 20°C

In other words, giving the front left speaker a time correction value of 5.1 ms makes it seem as if its distance from the listener is the same as the distance to the farthest speaker.

Time correction eliminates the differences in the time required for the sound to reach the listening position. The time of the front left speaker is corrected by 5.1 ms so that its sound reaches the listening position at the same time as the sound of other speakers.

Example 2. Listening Position: All Seats

Adjust the time correction level of each speaker to almost the same level.

- 1 Sit in the listening position (driver's seat, etc.) and measure the distance (in meters) between your head and the various speakers.
- 2 Calculate the difference between the distance correction value to the farthest speaker and the other speakers.

$L = (\text{distance to farthest speaker}) - (\text{distance to other speakers})$

These values are the time correction values for the different speakers. Setting these values to make each sound reach the listening position at the same time as the sound of other speakers.

Time Correction Value List

Time Difference (msec)	Distance (cm)	Distance (inch)	Time Difference (msec)	Distance (cm)	Distance (inch)
0.0	0.0	0.0	5.1	173.4	68.3
0.1	3.4	1.3	5.2	176.8	69.7
0.2	6.8	2.7	5.3	180.2	71.0
0.3	10.2	4.0	5.4	183.6	72.4
0.4	13.6	5.4	5.5	187.0	73.7
0.5	17.0	6.7	5.6	190.4	75.0
0.6	20.4	8.0	5.7	193.8	76.4
0.7	23.8	9.4	5.8	197.2	77.7
0.8	27.2	10.7	5.9	200.6	79.1
0.9	30.6	12.1	6.0	204.0	80.4
1.0	34.0	13.4	6.1	207.4	81.7
1.1	37.4	14.7	6.2	210.8	83.1
1.2	40.8	16.1	6.3	214.2	84.4
1.3	44.2	17.4	6.4	217.6	85.8
1.4	47.6	18.8	6.5	221.0	87.1
1.5	51.0	20.1	6.6	224.4	88.4
1.6	54.4	21.4	6.7	227.8	89.8
1.7	57.8	22.8	6.8	231.2	91.1
1.8	61.2	24.1	6.9	234.6	92.5
1.9	64.6	25.5	7.0	238.0	93.8
2.0	68.0	26.8	7.1	241.4	95.1
2.1	71.4	28.1	7.2	244.8	96.5
2.2	74.8	29.5	7.3	248.2	97.8
2.3	78.2	30.8	7.4	251.6	99.2
2.4	81.6	32.2	7.5	255.0	100.5
2.5	85.0	33.5	7.6	258.4	101.8
2.6	88.4	34.8	7.7	261.8	103.2
2.7	91.8	36.2	7.8	265.2	104.5
2.8	95.2	37.5	7.9	268.6	105.9
2.9	98.6	38.9	8.0	272.0	107.2
3.0	102.0	40.2	8.1	275.4	108.5
3.1	105.4	41.5	8.2	278.8	109.9
3.2	108.8	42.9	8.3	282.2	111.2
3.3	112.2	44.2	8.4	285.6	112.6
3.4	115.6	45.6	8.5	289.0	113.9
3.5	119.0	46.9	8.6	292.4	115.2
3.6	122.4	48.2	8.7	295.8	116.6
3.7	125.8	49.6	8.8	299.2	117.9
3.8	129.2	50.9	8.9	302.6	119.3
3.9	132.6	52.3	9.0	306.0	120.6
4.0	136.0	53.6	9.1	309.4	121.9
4.1	139.4	54.9	9.2	312.8	123.3
4.2	142.8	56.3	9.3	316.2	124.6
4.3	146.2	57.6	9.4	319.6	126.0
4.4	149.6	59.0	9.5	323.0	127.3
4.5	153.0	60.3	9.6	326.4	128.6
4.6	156.4	61.6	9.7	329.8	130.0
4.7	159.8	63.0	9.8	333.2	131.3
4.8	163.2	64.3	9.9	336.6	132.7
4.9	166.6	65.7			
5.0	170.0	67.0			

Apple CarPlay (Optional)

Apple CarPlay is a smarter, safer way to use your iPhone in the car. Apple CarPlay takes the things you want to do with your iPhone while driving and puts them right on the unit. You can get directions, make calls, send and receive messages, and listen to music, all in a way that allows you to stay focused on the road. Just plug in your iPhone to the unit and go.

- Before using this function, plug in your iPhone using Lightning to USB Cable (Supplied with iPhone) to the unit.
- Some functions may not be available while driving.
- About iPhone models usable with this unit, see "iPod mode on iPhone (Optional)" (page 39). Only an iPhone 5s or later compatible with Apple CarPlay function.
- Before operating Apple CarPlay, set "Apple CarPlay" to [On] (page 21).

Access to Apple CarPlay

1 Touch the (HOME) button.

The HOME screen is displayed.

2 Touch [Apple CarPlay].



[Apple CarPlay] button

The Apple CarPlay screen is displayed.

Touch the desired App icon on the unit, or use Siri function by touching the  button.

- When a used iPhone 5s or later is reconnected, touch the pop-up message-"Apple CarPlay connected." within 5 seconds to access to Apple CarPlay screen, or you can ignore prompt by touching [] on the top right.
- The App must be Apple CarPlay compatible in order to appear in the Home screen.

Android Auto (Optional)

What is Android Auto

Android Auto brings your favorite smartphone apps into one place, making it easier for drivers to access their favorite navigation, media, and communication apps on the road while minimizing the distractions. Talk to Google on Android Auto™ and get things done with your voice so you can keep your eyes on the road and hands on the wheel. Easily send messages, get directions, control media and more. Just say, "Hey Google" or long-press the voice control button on your steering wheel.

Activate Android Auto

Download the Android Auto App from the Google Play store before continuing.

Just plug in your smartphone to the unit's USB connector, then follow the prompt to pair your smartphone with the unit.

- The connected smartphone with Android Auto will disconnect other phone's Bluetooth connection and pair to the unit.

1 Touch the (HOME) button.

The HOME screen is displayed.

2 Touch [Android Auto].



[Android Auto] button

The Android Auto screen is displayed.

- When a used smartphone is reconnected, touch the pop-up message-"Android Auto connected" within 5 seconds to access to Android Auto screen, or you can ignore prompt by touching [] on the top right.
- You can make a call, use voice recognition function and Android Auto's compatible navigation app, etc.
- Only Google approved apps with necessary driver-safety measures in place can be used.