

Jeep Wrangler HCE-RCAM-WRA Stealth-Mount Spare Tire Camera Installation Manual

- Model: Wrangler
- Model Year: 2007-2018

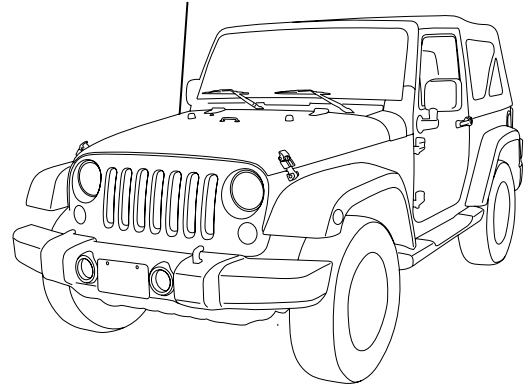

	Model	Year
Jeep	Wrangler (JK)	2007-2018
	Wrangler Unlimited (JK)	2007-2018

* The specified vehicles have been tested and have met compatibility specs at the time of testing. Compatibility is not guaranteed if the manufacturer has made production changes to the listed vehicles above.

⚠ Warning: Before you begin wiring, remove the ground wire from the negative terminal of the battery. Failing to do so can lead to electric shock, injury or damage to equipment.

Introduction

- Congratulations on purchasing the HCE-RCAM-WRA. This installation manual is designed to take you through the installation of HCE-RCAM-WRA. Please familiarize yourself with the owners manual and if you still have additional questions please call 1-800-TECH-101.

Note

- Design and specifications are subject to change without notice for improvement.





To Ensure Safe Use, Always Follow These Precautions

- The installation of this product requires specialized skills and experience. We recommend that you have the product installed by an Alpine authorized dealer.
- Before you use this product, be sure to carefully read this installation manual and the separate user's manual so that you can use the product correctly. Alpine Electronics bears no responsibility for problems that arise as a result of failure to follow the instructions in the manuals.
- This manual includes a number of symbols that are intended to help you use the product safely, to prevent harm to you and others, and to protect against damage to property. These symbols and their meanings are listed below. Make sure you fully understand these symbols before you begin reading the main text.

Explanations of Injury and Damage That May Result from Incorrect Use

Warning	Ignoring the content marked by this indication and using the product incorrectly is expected to lead to death or serious injury.
Caution	Ignoring the content marked by this indication and using the product incorrectly is only expected to lead to injury or property damage.



Types of Precautions

 Forbidden	Indicates actions that are forbidden (must not be performed)
 Forbidden	Indicates that disassembly is forbidden.
 Mandatory	Indicates actions that are mandatory (must be performed)
	Marks content that should receive your full attention.

 **Warning**

Do not disassemble or modify the product. Doing so could lead to an accident, fire, or electric shock.  Forbidden

Store screws and other small objects where small children cannot reach them. If one of these small objects is swallowed, consult with a doctor immediately. 

When replacing fuses, be sure to use fuses with the specified current rating. Failing to do so could lead to an accident or fire.  Forbidden  Mandatory

Only connect the product to a 12 VDC negative ground car. Failing to do so could lead to an accident or fire.  Mandatory

Before you begin wiring, remove the ground wire from the negative terminal of the battery. Failing to do so could lead to electric shock or injury. 

Do not cut the insulation on a cord and take power from another device. Doing so could lead to fire or electric shock.  Forbidden

Do not install the product in a location where it will obstruct the driver's forward view; interfere with the operation of the steering wheel, gearshift, or the like; or pose a threat to passengers. Doing so could lead to an accident or injury.  Forbidden

When making a hole in the vehicle body, be careful to avoid damaging pipes, the fuel tank, electrical wiring, and the like. This kind of damage could lead to an accident or fire. 

When installing and grounding the product, do not use any of the bolts or nuts of the steering wheel, brakes, fuel tank, or the like. Doing so could make the brakes stop working or lead to fire.  Forbidden

Do not install the product near the passenger-side airbag. Doing so could interfere with the operation of the airbag and lead to an accident or injury.  Forbidden

Bundle cords so that they don't interfere with driving. Wrapping cords around the steering wheel, gearshift, brake pedal, or the like, could lead to an accident or damage equipment. 

 **Caution**

Connect the product properly according to the instructions. Failing to do so could lead to fire or an accident.  Forbidden

Do not sandwich cords between the seat railing or allow them to touch protrusions. Resulting breaks or shorts could lead to electric shock or fire. 



Do not block vents or heat sinks. Doing so could lead to fire or damage equipment. 

Use the accessories according to the instructions, and attach them securely. Failing to do so could lead to an accident or damage equipment.  Forbidden





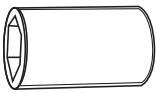
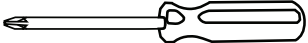
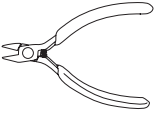
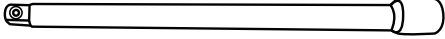
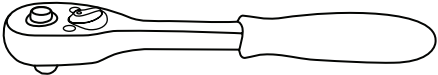

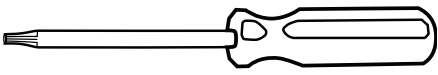
Do not install the product where it may be exposed to water or in a place with high levels of humidity or dust. Doing so could lead to fire or damage equipment.  Forbidden

The installation and wiring of this product requires specialized skills and experience. Have the product installed by an Alpine authorized dealer. 

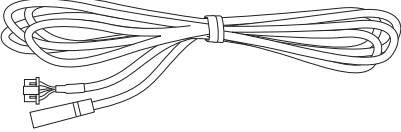
Tools Possibly Required (This Will Vary Depending On The Vehicle)

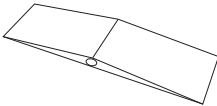
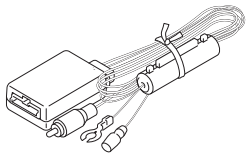
Panel Removing Tool	Sockets	Phillips Screwdriver
		
Wire Cutters	Extension	Ratchet
		
Crimpers	Pliers	Torx Screwdriver
		

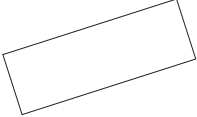
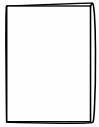
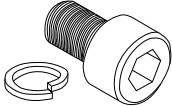
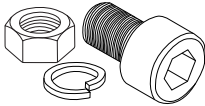
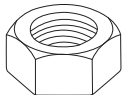
Accessory List

Camera Bracket With HCE-C1100 Pre-assembled	Camera Extension Cable (7M/23FT)	Spare Tire Bracket
		
Cable Ties x 5	Waterproofing Pad x 1	Power & Video Unit
		
Retaining Clips x 3	Waterproofing Pad Adhesive x 1	Quick Installation Guide x 1
		
Torx Screw & Lock Washer M6x8 x 1	Torx Screw, Lock Washer, & Nut M6x12 x 1	Nut For M6x12 Screw x 1 (Spare only, not used)
		
Heat Shrink Tubing x 1	Allen Wrench x 1	
		

Factory Unit Disassembly Process (2007-2010 Only)

⚠ Warning: Before you begin wiring, remove the ground wire from the negative terminal of the battery. Failing to do so can lead to electric shock, injury or damage to equipment.

⚠ DISCONNECT THE BATTERY BEFORE CONTINUING. FAILURE TO DO SO WILL DISABLE MANY FEATURES.

1 Remove top by releasing 2 rear clips on the back of the top panel and then pull panel forward.

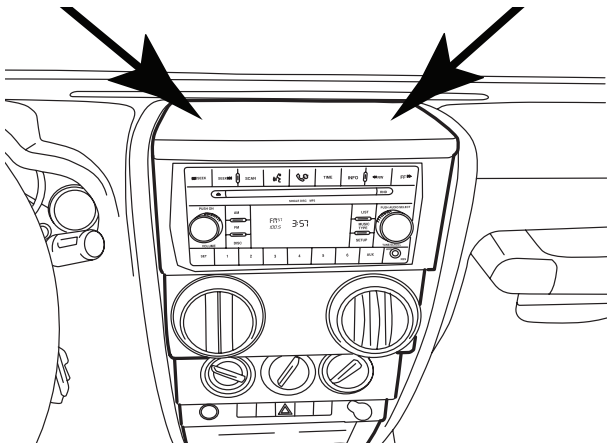

2 Release 2 clips on the top of the bottom panel. This will expose two 7mm screws. Remove those.

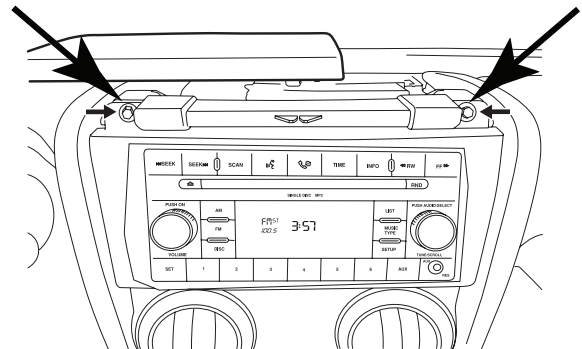

3 Release 2 clips on the top of the bottom panel. This will expose two 7mm screws. Remove using a 7mm socket with ratchet & extension.

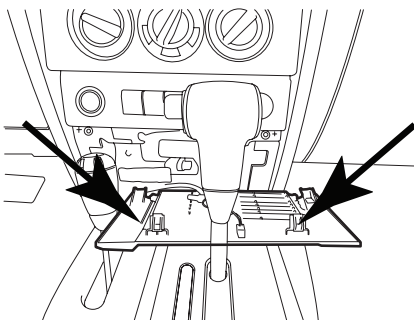

4 Use panel removal tool to remove dash panel by releasing 6 clips (3 per side)

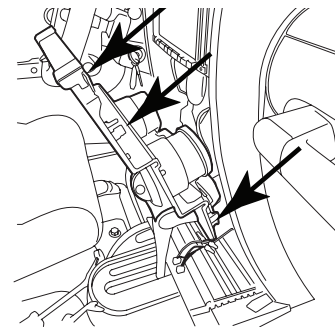

5 Extract (4) 7 mm screws and remove the factory radio.

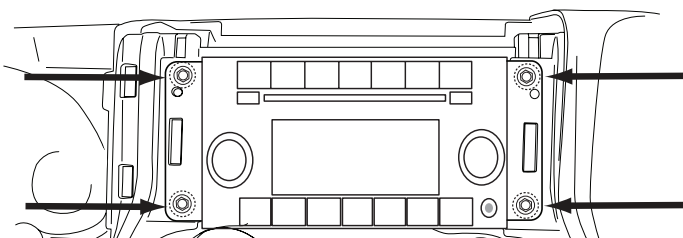

Factory Unit Disassembly Process (2011-2018 Only)

⚠ DISCONNECT THE BATTERY BEFORE CONTINUING. FAILURE TO DO SO WILL DISABLE MANY FEATURES.

- 1** Remove the rubber cover from the top center storage area and extract (1) 7mm screw.

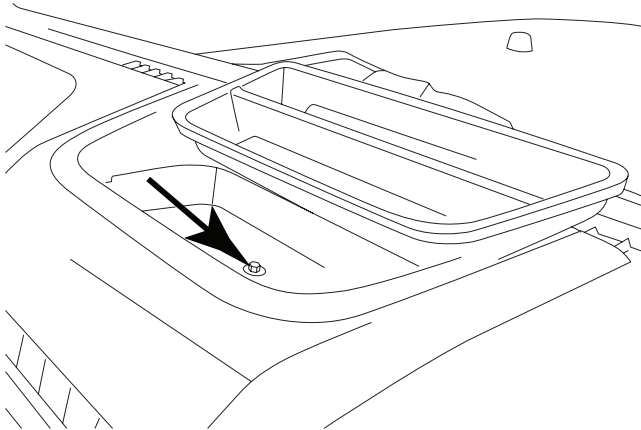

- 2** Remove the knee cover panel and extract (2) 7mm screws located to the right and left sides of the steering wheel column.

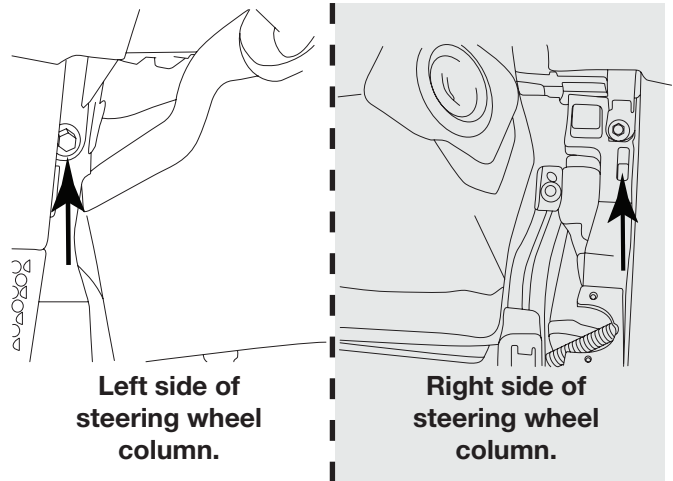

- 3** Remove the window switch pod using a panel removing tool and extract (1) 7mm screw.

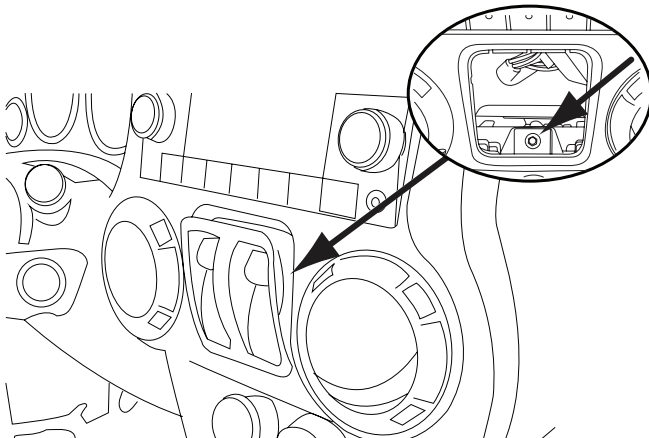

- 4** Remove the dash panel.

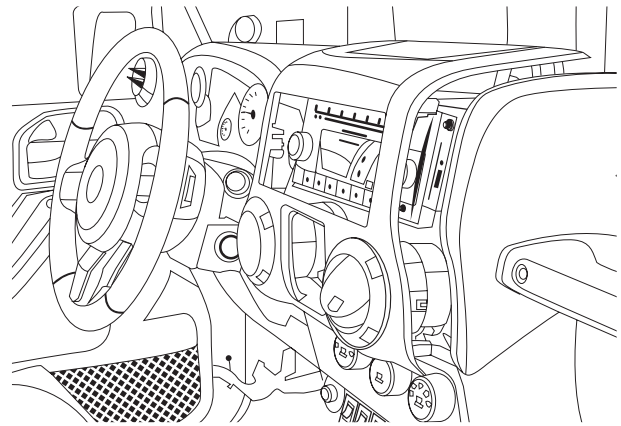

- 5** Extract (4) 7 mm screws and remove the factory radio.

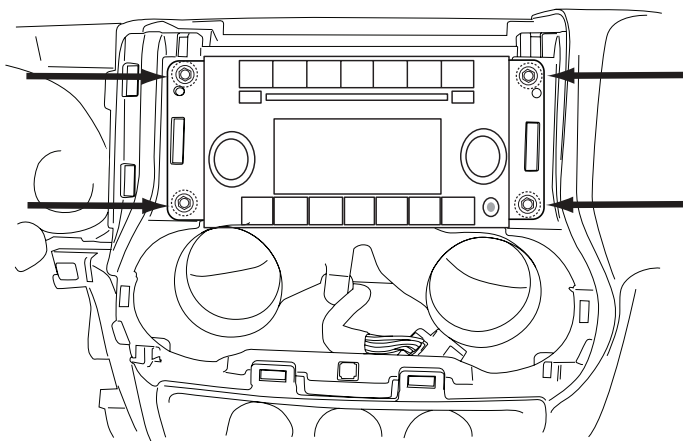

- 6** Extract (2) 7 mm screws from the factory radio bracket and remove it.

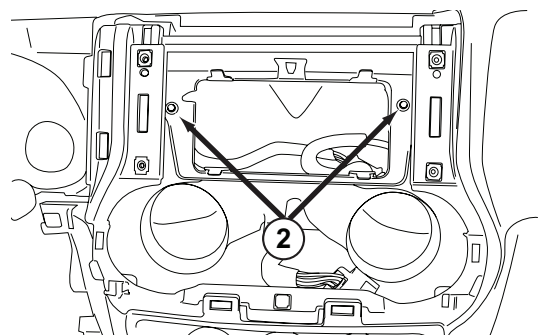

Glove Box Removal

- 1 Open the glove box.
- 2 Push inwards both left and right sides to release the glove box out.

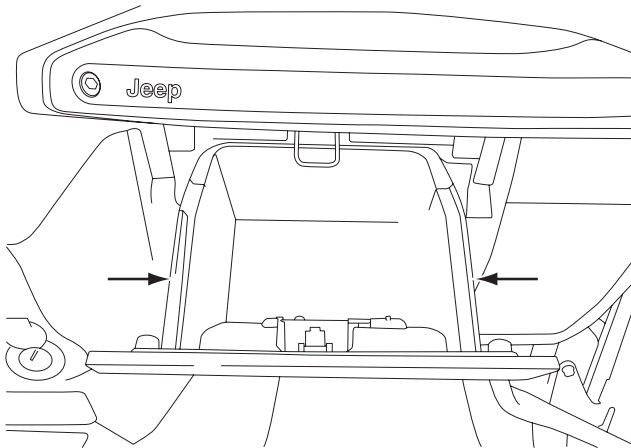

Removing B-Pillar Panel

- 1 Remove B-Pillar panel by disengaging 4 clips on both front and rear passenger sides.

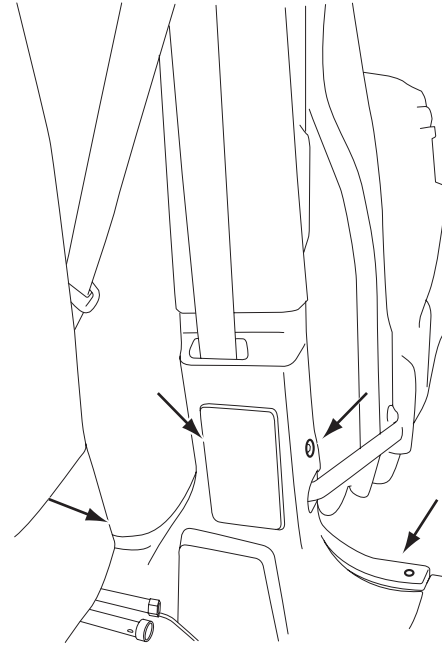

- 2 Using panel removing tool, unclip the B-Pillar. Be careful not to damage the panel.
- 3 Lift the carpet up on both front and rear passenger sides to expose the OEM cables.

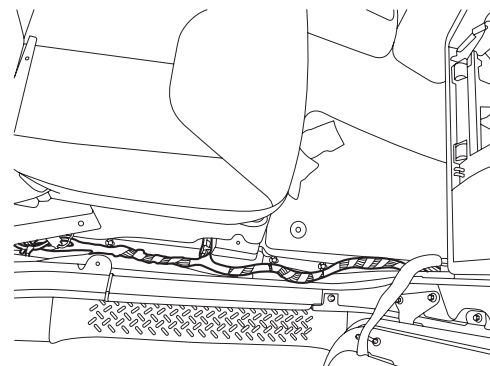

Removing Rear Right Side Panel

- 1 Using T25 Torx, remove the screws on the rear right side panel.

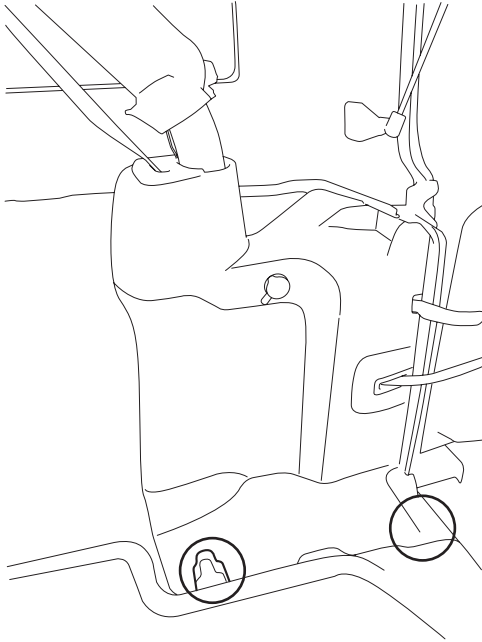

- 2 Using panel removing tools, pry off seatbelt cover[#1] and remove the roll cage cover[#2].

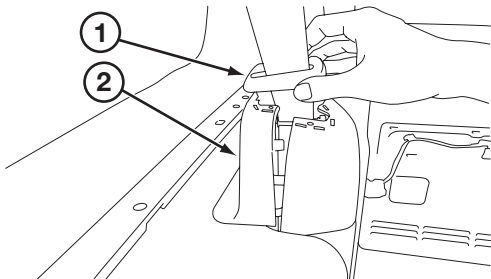

- 3 Using 10mm socket to remove the panel.

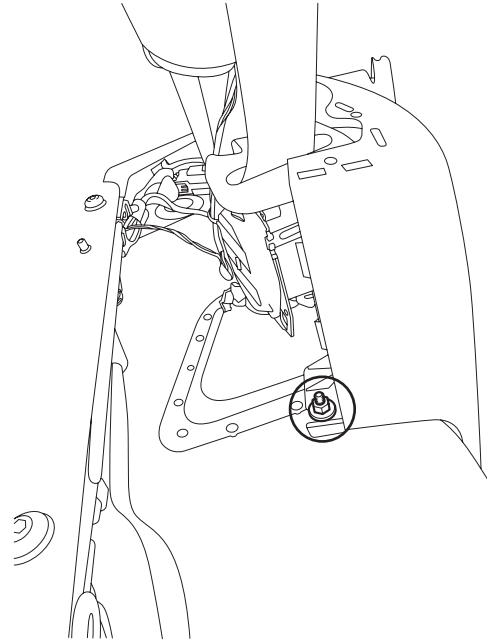

- 4 Unclip the cigarette lighter socket from the harness.

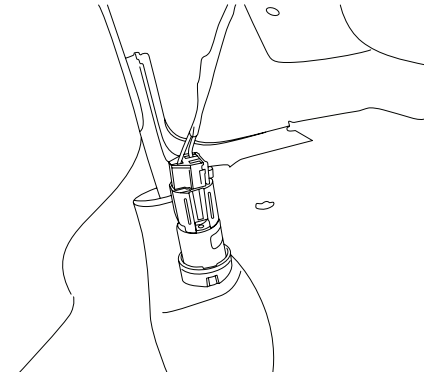

- 5 Remove the Rear Right Side Panel.

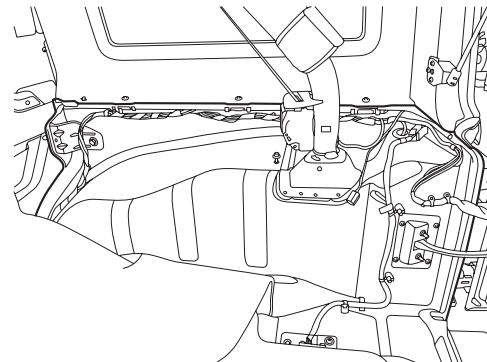

Spare Tire and Wheel Removal

- 1 Using 19mm socket, extract the lug nuts.

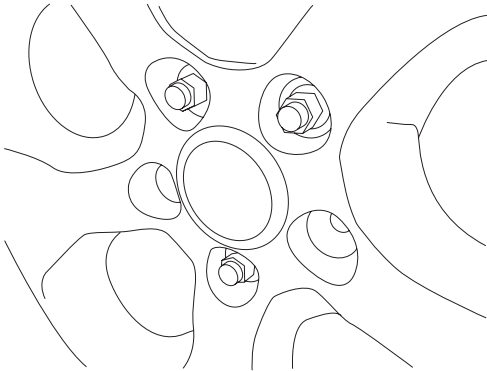

- 3 Using panel removing tools, unclip and remove wire cover on the rear gate.

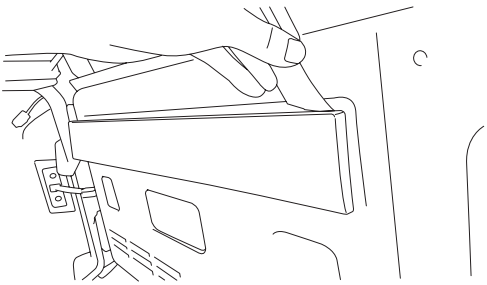

- 4 Using panel removing tools, unclip and remove vent cover on the rear gate.

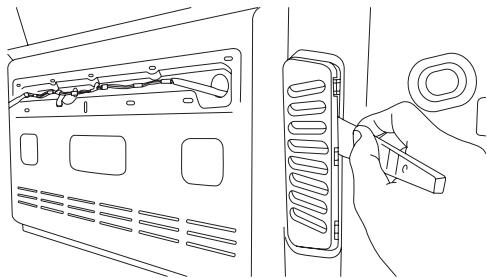

Camera & Light Extension Cable Installation

- 1 Route the wires:

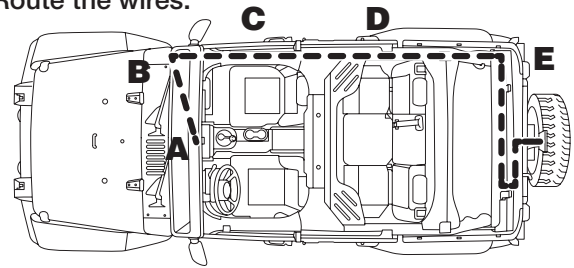

- A. Start from the head unit harness
- B. Behind the glove box
- C. Down the passenger kick panel
- D. Door sill
- E. Along the rear right side panel

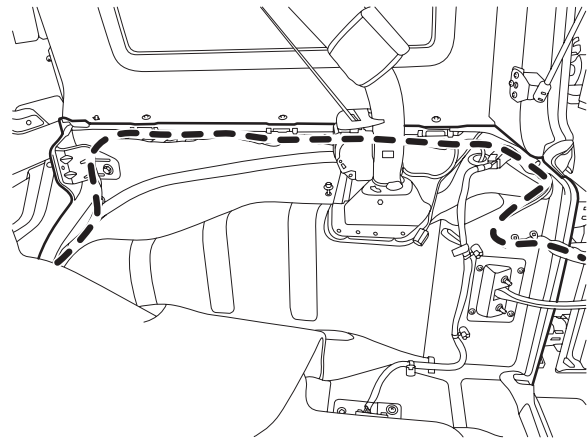

- F. Along the rear door handle cable

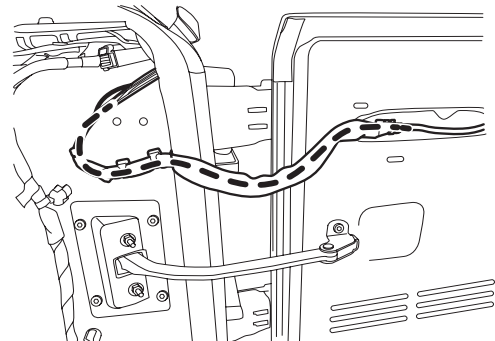

Camera & Light Extension Cable Installation

G. Secure to the factory cables.

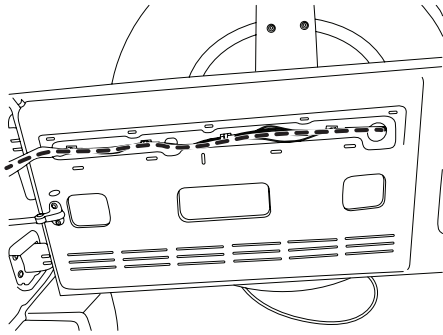

H. Remove OEM grommet. Route the wire out of an OEM grommet hole. Insert the camera harness cable and the OEM third brake light cable through the rubber grommet provided. Cut rubber grommet by a razor blade if needed. Press the grommet firmly into the hole.

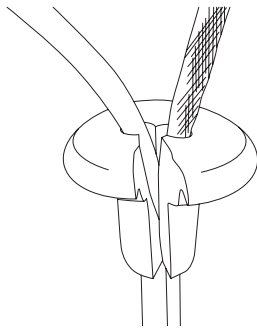

I. Route along and through the centric hub.

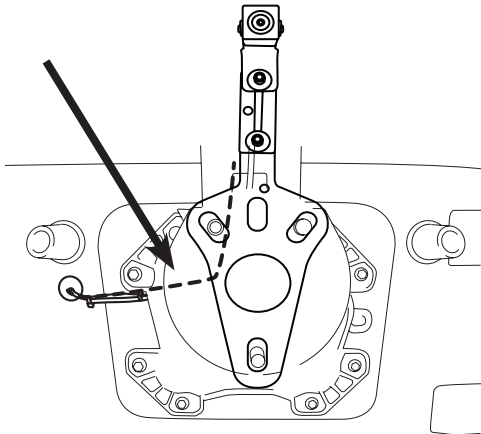

⚠ Route the cable so it does not interfere with any moving parts or safety equipment.

⚠ Use silicone to fill up all gaps around the grommet and cables to prevent water going into the rear gate.

⚠ Failure to do so may cause moisture to go inside.

Bracket Installation

- 1) Attach camera bracket (which already uses the M6x8 & Lock Washer pre-assembled) to spare tire bracket using the supplied allen wrench, M6x12 torx screw, lock washer, and nut.
- 2) Adjust the bracket for the camera height.
- 3) Place bracket with camera over the studs and slide to the back. There's usually 2 on the top and 1 on the bottom.
- 4) Slide retaining clips over the studs to hold the bracket in place.
- 5) Check the spacing of the bracket by placing the spare tire back over the studs.
- 6) If spacing is correct use 19mm socket to re-install spare tire.

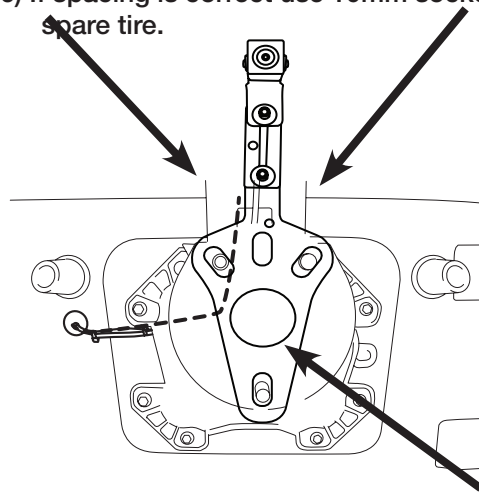

Wiring Diagram: OEM Head Unit With SGS-CH01 (Sold Separately)

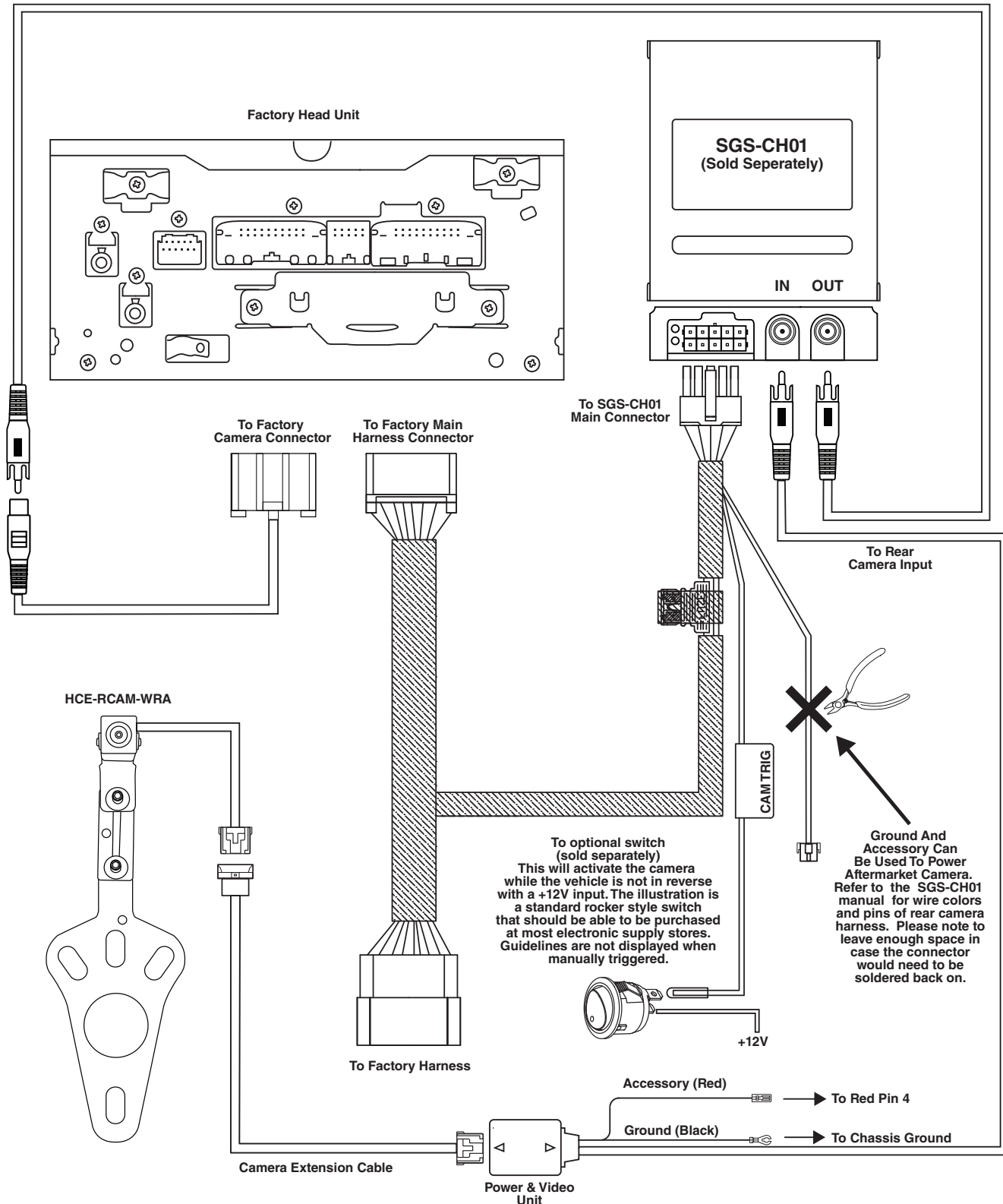

Wiring Diagram: OEM Head Unit With ALP-HRN-CAMCH (Sold Separately)

Factory Head Unit

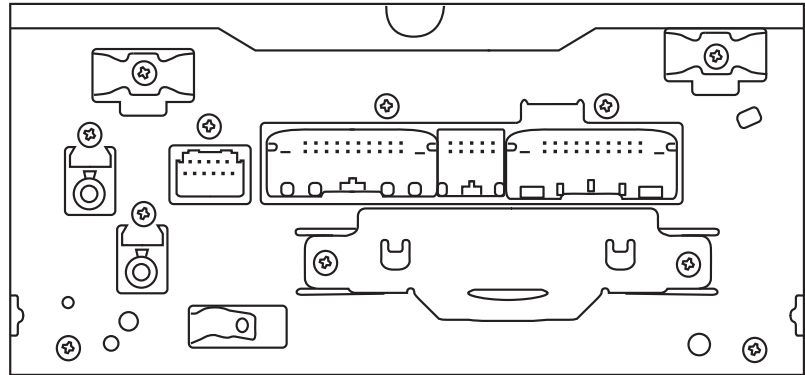

To Factory Camera Connector

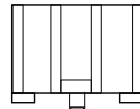

ALP-HRN-CAMCH
(Sold Separately)



NOTE:
The OEM radio will need to be flashed by a Jeep dealer to enable the rear camera feature when using the ALP-HRN-CAMCH

HCE-RCAM-WRA

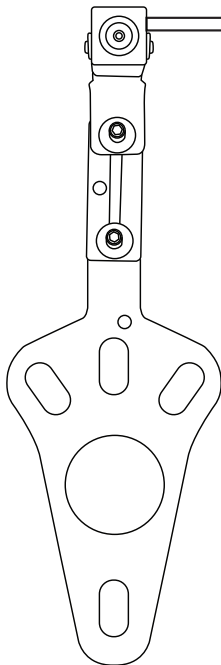

To Rear Camera Input

Power & Video Unit

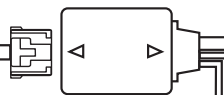

Camera Extension Cable

To White/Gray +12V reverse wire in the passenger kick panel

Red

To chassis ground

Black

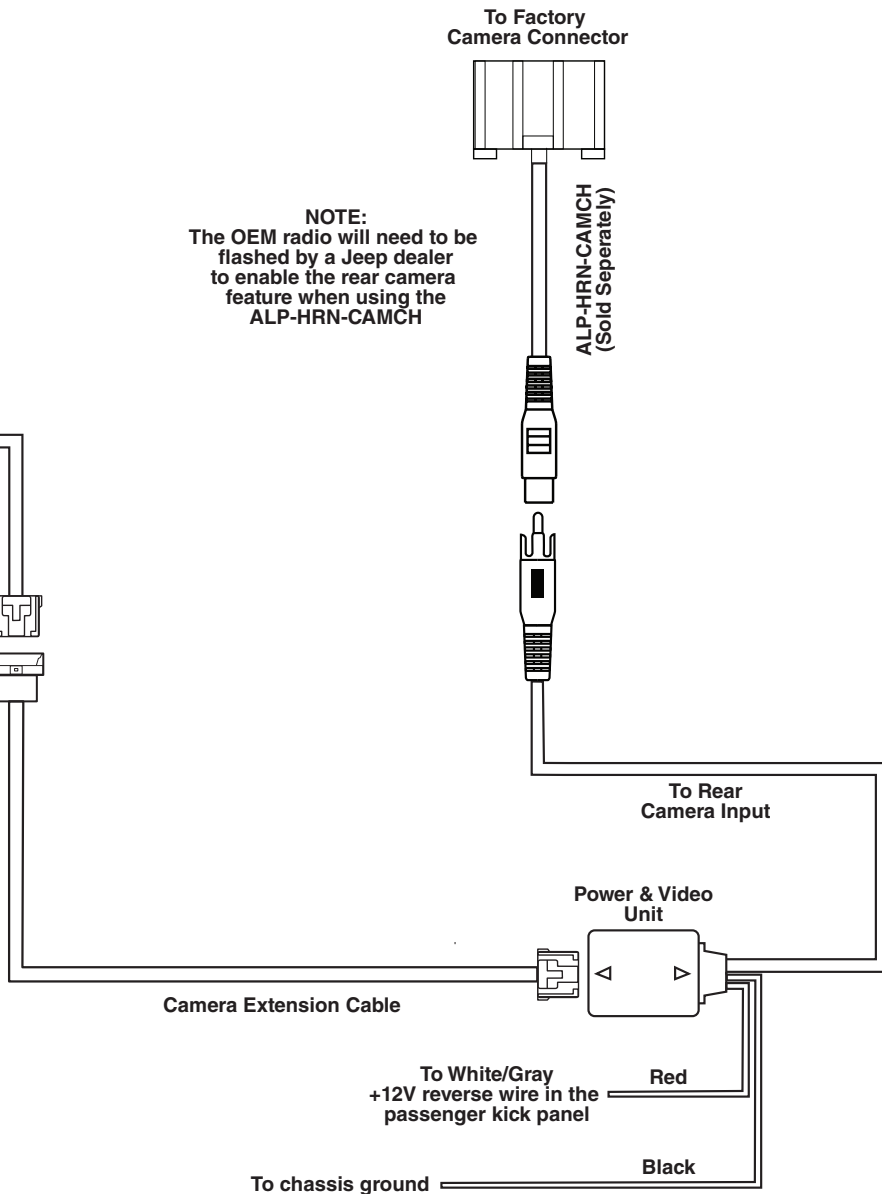

Wiring Diagram: Alpine Head Unit Using Direct Connection

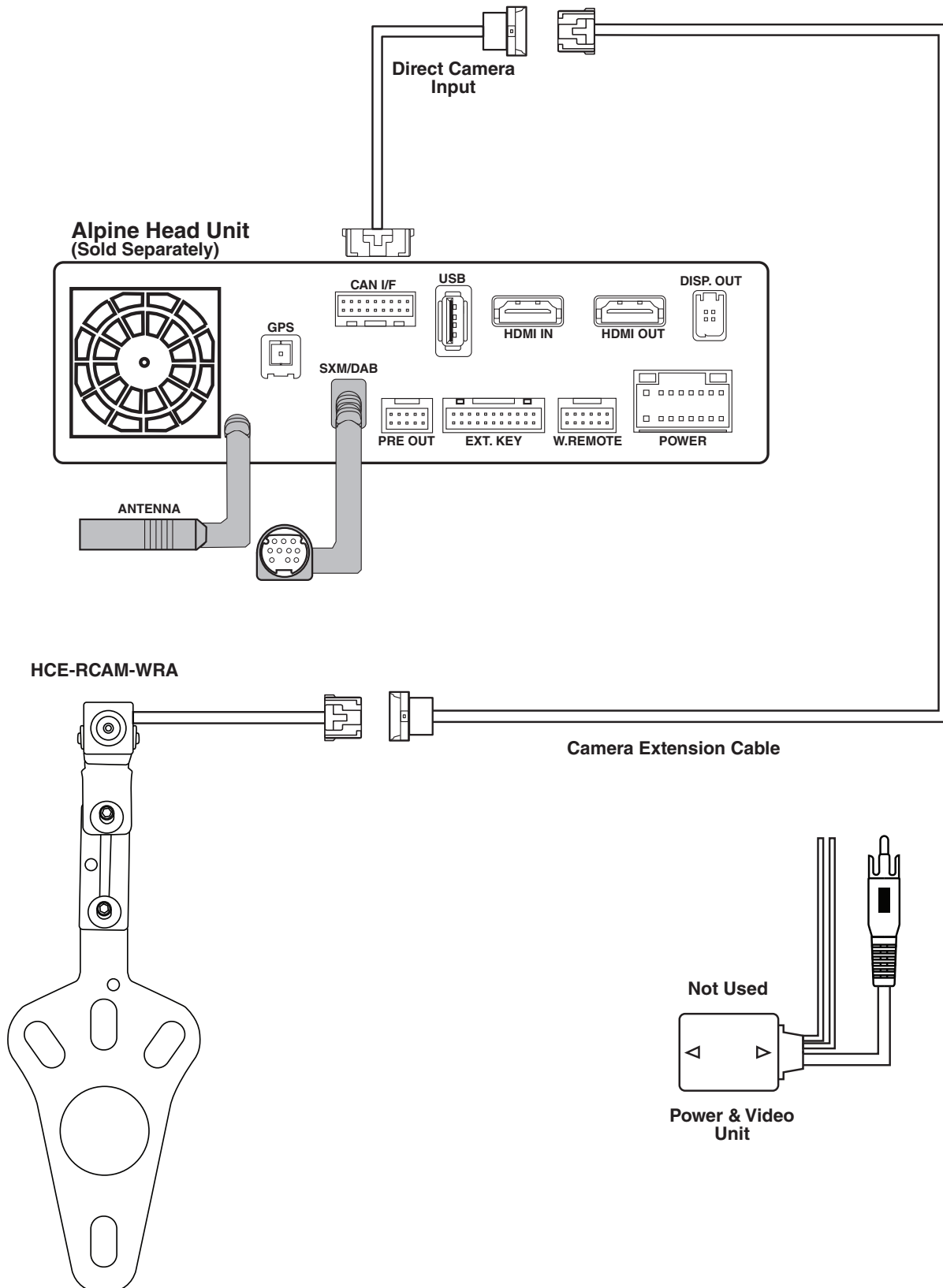

Wiring Diagram: Alpine Head Unit With SGS-CH01 (Sold Separately)

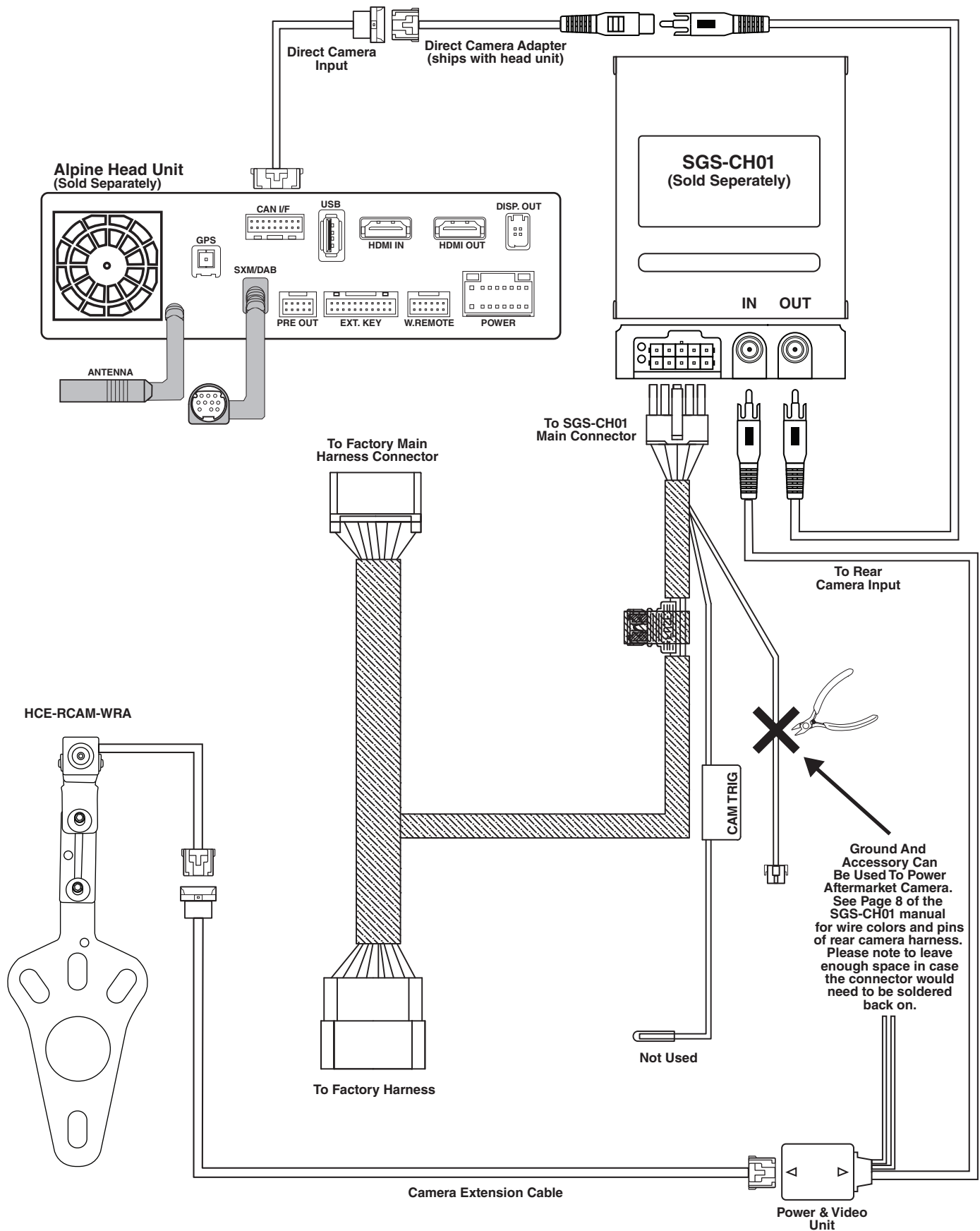

Wiring Diagram: OEM Head Unit With SGS-CH01 & KCX-C2600B (Sold Separately)

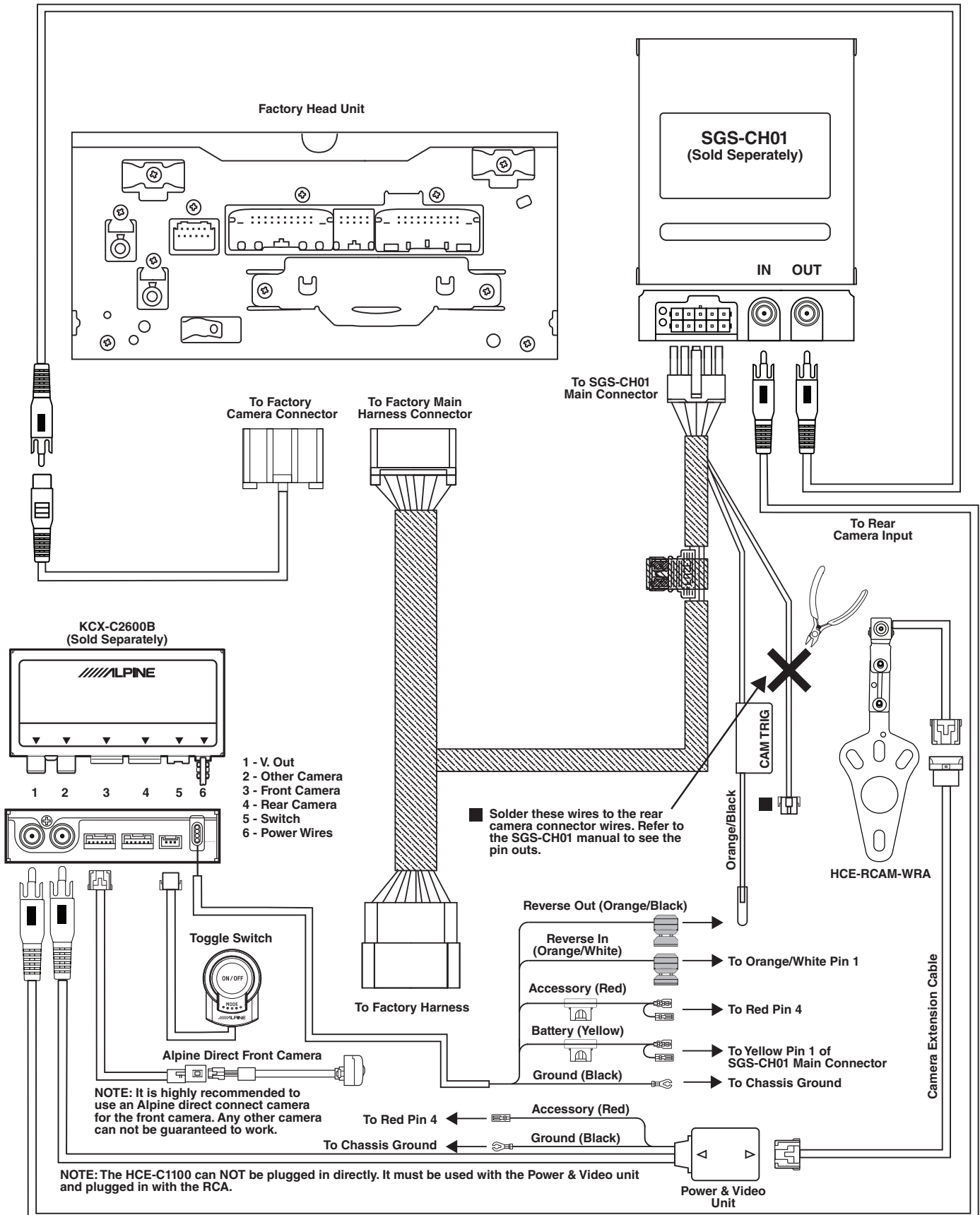

Wiring Diagram: OEM Head Unit With ALP-HRN-CAMCH & KCX-C2600B (Sold Separately)

Factory Head Unit

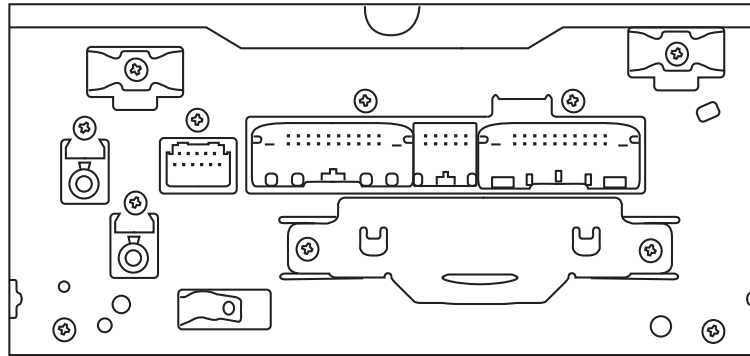

To Factory Camera Connector

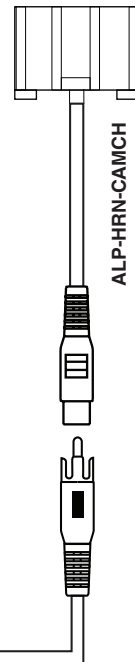

HCE-RCAM-WRA

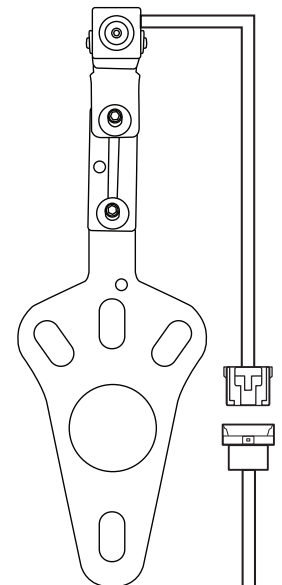

NOTE:
The OEM radio will need to be flashed by a Jeep dealer to enable the rear camera feature when using the ALP-HRN-CAMCH

To Rear Camera Input

KCX-C2600B (Sold Separately)

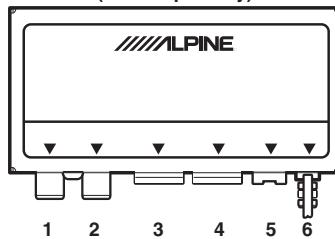

- 1 - V. Out
- 2 - Other Camera
- 3 - Front Camera
- 4 - Rear Camera
- 5 - Switch
- 6 - Power Wires

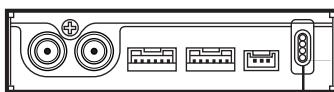

Toggle Switch



Alpine Direct Front Camera

NOTE: It is highly recommended to use an Alpine direct connect camera for the front camera. Any other camera can not be guaranteed to work.

Reverse Out (Orange/Black)

Reverse In (Orange/White)

Accessory (Red)

Battery (Yellow)

Ground (Black)

Accessory (Red)

Ground (Black)

Camera Extension Cable

Power & Video Unit

NOTE: The HCE-C1100 can NOT be plugged in directly. It must be used with the Power & Video unit and plugged in with the RCA.

Troubleshooting

Symptom		Possible Cause	Remedy
1	Alpine head unit only shows guidelines in reverse.	The HCE-RCAM-WRA camera is not outputting a picture.	Check to make sure the camera is being powered on with a digital multimeter.
			Test camera with a different display. Plug the RCA of the camera into a display with a RCA input.
			Alternatively, you can use a different RCA source into the RCA input. For example, an old DVD player with a RCA output would show a picture with the vehicle in reverse. This will eliminate if the issue is with the head unit or the camera installation.
2	Nothing happens when vehicle is in reverse	The SGS-CH01 is not installed properly.	Refer to the SGS-CH01 installation manual and troubleshooting.
		ALP-HRN-CAMCH was used and the dealership did not flash OEM radio.	Take vehicle to Jeep dealer and have them flash the OEM radio to turn on the rear camera input.
3	OEM radio not showing grid lines.	That's not a feature of the OEM radio.	The OEM radio does not generate grid lines. The camera does not have any kind of output for something like that.