

Lynx Shunt VE.Can

Table of Contents

1. Safety Precautions	1
1.1. Safety Warnings Lynx Distribution System	1
1.2. Transport and Storage	1
2. Introduction	2
2.1. The Lynx Shunt VE.Can	2
2.2. GX device	2
2.3. Temperature sensor	3
2.4. VictronConnect App	3
2.5. The Lynx Distribution System	3
3. Features	4
3.1. Internal parts and wiring diagram Lynx Shunt VE.Can	4
3.2. Main fuse	5
3.3. Battery Monitor (shunt)	5
3.4. Alarm relay Lynx Shunt VE.Can	5
3.5. Temperature sensor	6
4. Communication and interfacing	7
4.1. GX Device	7
4.2. NMEA2000	7
5. System Design	8
5.1. Lynx distribution system parts	8
5.1.1. Interconnecting Lynx modules	8
5.1.2. Orientation of Lynx modules	8
5.1.3. System example - Lynx Shunt VE.Can, Lynx Power In, Lynx Distributor and lead acid batteries	9
5.2. System sizing	10
5.2.1. Current rating Lynx modules	10
5.2.2. Fusing	10
5.2.3. Cabling	11
6. Installation	12
6.1. Mechanical connections	12
6.1.1. Lynx module connection features	12
6.1.2. Mounting and interconnecting Lynx modules	12
6.2. Electrical connections	13
6.2.1. Connect DC wires	13
6.2.2. Connect the temperature sensor	13
6.2.3. Connect the alarm relay	13
6.2.4. Place main fuse	14
6.2.5. Connect the GX device	14
6.3. Configuration and settings	15
6.3.1. Settings Lynx Shunt VE.Can	15
7. Commissioning the Lynx Shunt VE.Can	17
8. Operation Lynx Shunt VE.Can	18
9. Battery monitor settings	20
9.1. Battery capacity	20
9.2. Charged voltage	20
9.3. Tail current	20
9.4. Charged detection time	20
9.5. Peukert exponent	20
9.6. Charge efficiency factor	21
9.7. Current threshold	21
9.8. Time-to-go averaging period	21
9.9. Synchronise SoC to 100%	21

9.10. Zero current calibration 21

10. Battery capacity and Peukert exponent 22

11. Troubleshooting and Support 24

11.1. Cabling issues 24

11.2. Main fuse issues 24

11.3. Battery monitor issues 24

11.3.1. Charge and discharge current are inverted 24

11.3.2. Incomplete current reading 24

11.3.3. There is a current reading while no current flows 24

11.3.4. Incorrect state of charge reading 25

11.3.5. State of charge always shows 100% 25

11.3.6. State of charge does not reach 100% 25

11.3.7. State of charge does not increase fast enough or too fast when charging 25

11.3.8. State of charge is missing 25

11.3.9. Synchronisation issues 26

11.4. GX device issues 26

12. Warranty 27

13. Technical specifications Lynx Shunt VE.Can 28

14. Appendix 29

1. Safety Precautions

1.1. Safety Warnings Lynx Distribution System



- Do not work on live busbars. Ensure that the busbar is unpowered by disconnecting all positive battery poles prior to removing the Lynx front cover.
- Work on batteries should be carried out by qualified personnel only. Observe the battery safety warnings as listed in the battery manual.

1.2. Transport and Storage

Store this product in a dry environment.

The storage temperature should be: -40°C to +65°C.

No liability can be accepted for damage in transit if the equipment is not transported in its original packaging.

2. Introduction

2.1. The Lynx Shunt VE.Can

The Lynx Shunt VE.Can contains a positive and negative busbar, a battery monitor and a fuse holder for the main system fuse. It is part of the Lynx Distribution system.

The Lynx Distributor has a power LED.

The Lynx Shunt VE.Can can communicate via VE.Can with an GX device.

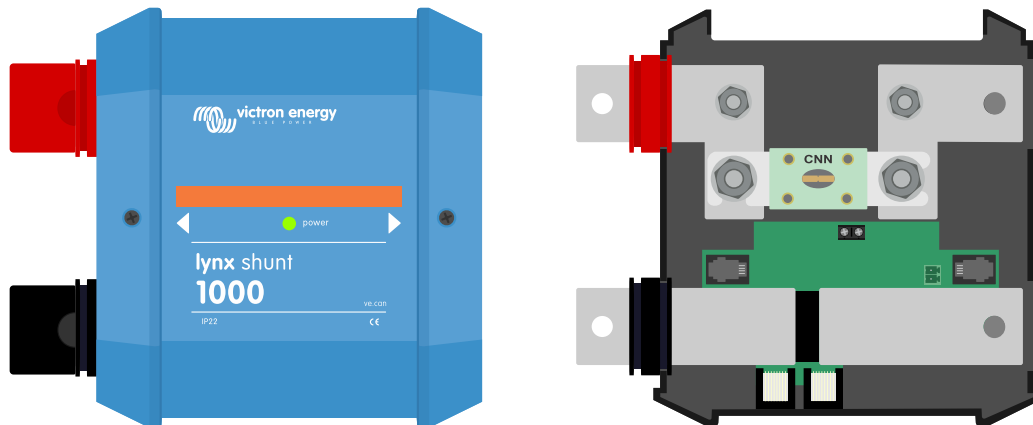

The Lynx Shunt VE.Can - with and without cover

The Lynx Shunt VE.Can ships with two RJ45 VE.Can terminators, these are used when connecting to a GX device.

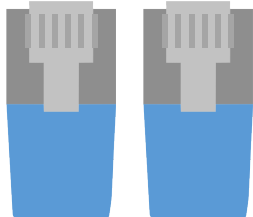

Two RJ45 VE.Can terminators

The Lynx Shunt VE.Can is designed to hold a CNN fuse. The fuse needs to be purchased separately. For more info see [Fusing \[10\]](#)

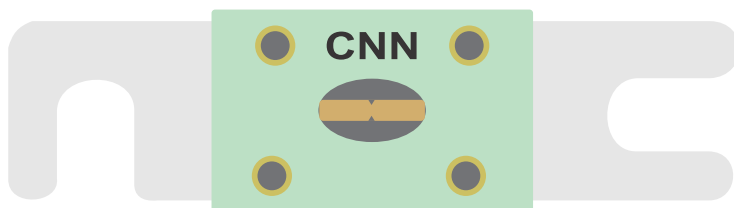

An example of an CNN fuse

2.2. GX device

The Lynx Shunt VE.Can can be monitored and setup with a GX device.

For more information on the GX device see the [GX device product page](#).

The GX device can be connected to the VRM portal allowing for remote monitoring.

For more information on the VRM portal see the [VRM page](#).

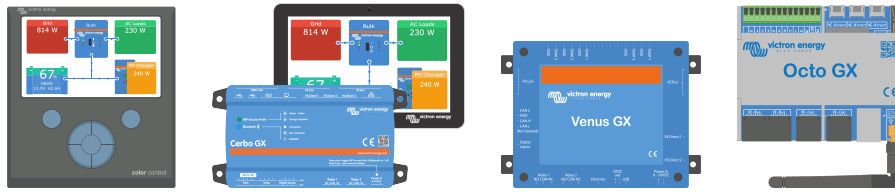

GX devices: CCGX, Cerbo GX & GX Touch, Venus GX and Octo GX

2.3. Temperature sensor

A temperature sensor can be connected to the Lynx Shunt VE.Can. It is used to measure the battery temperature.

The temperature sensor is an optional extra. It needs to be purchased separately. For more information see the [Temperature sensor QUA PMP GX device product page](#).

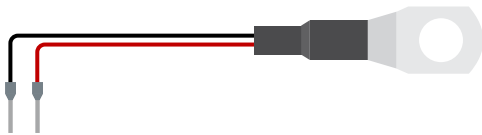

The temperature sensor QUA PMP GX device

2.4. VictronConnect App

For more information see the [VictronConnect App download page](#) and the [VictronConnect manual](#).

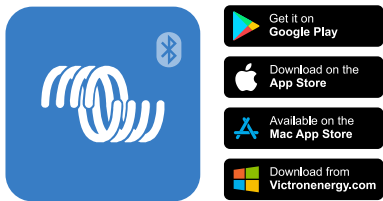

2.5. The Lynx Distribution System

The Lynx Distribution System is a modular busbar system that incorporates DC connections, distribution, fusing, battery monitoring and/or Lithium battery management. For more information also see the [DC Distribution Systems product page](#).

The Lynx Distribution System consist of the following parts:

- **Lynx Power In** - A positive and negative busbar with 4 connections for batteries or DC equipment.
- **Lynx Distributor** - A positive and negative busbar with 4 fused connections for batteries or DC equipment together with fuse monitoring.
- **Lynx Shunt VE.Can** - A positive busbar with a space for a main system fuse and a negative busbar with a shunt for battery monitoring. It has VE.Can communication for monitoring and setup with a GX device.
- **Lynx Smart BMS** - For use together with Victron Energy Smart Lithium batteries. It contains a positive busbar with a contactor that is driven by a battery management system (BMS) and a negative busbar with a shunt for battery monitoring. It has Bluetooth communication for monitoring and setup via the VictronConnect App and VE.Can communication for monitoring with a GX device and the VRM portal.

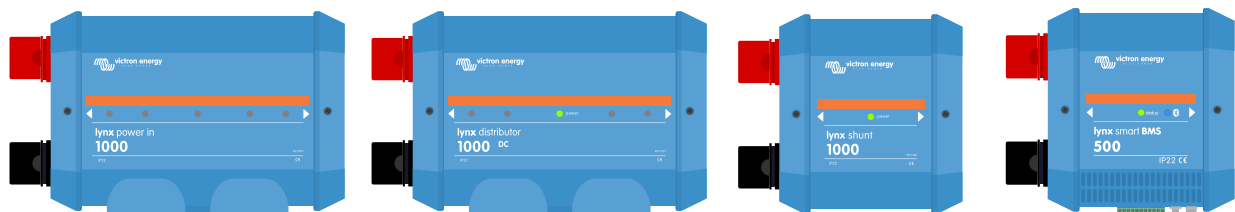

The Lynx modules: Lynx Power In, Lynx Distributor, Lynx Shunt VE.Can and Lynx Smart BMS

3. Features

3.1. Internal parts and wiring diagram Lynx Shunt VE.Can

The internal physical parts and the wiring diagram of the Lynx Shunt VE.Can indicating the following parts:

- Positive busbar
- Negative busbar
- Main system fuse
- Shunt

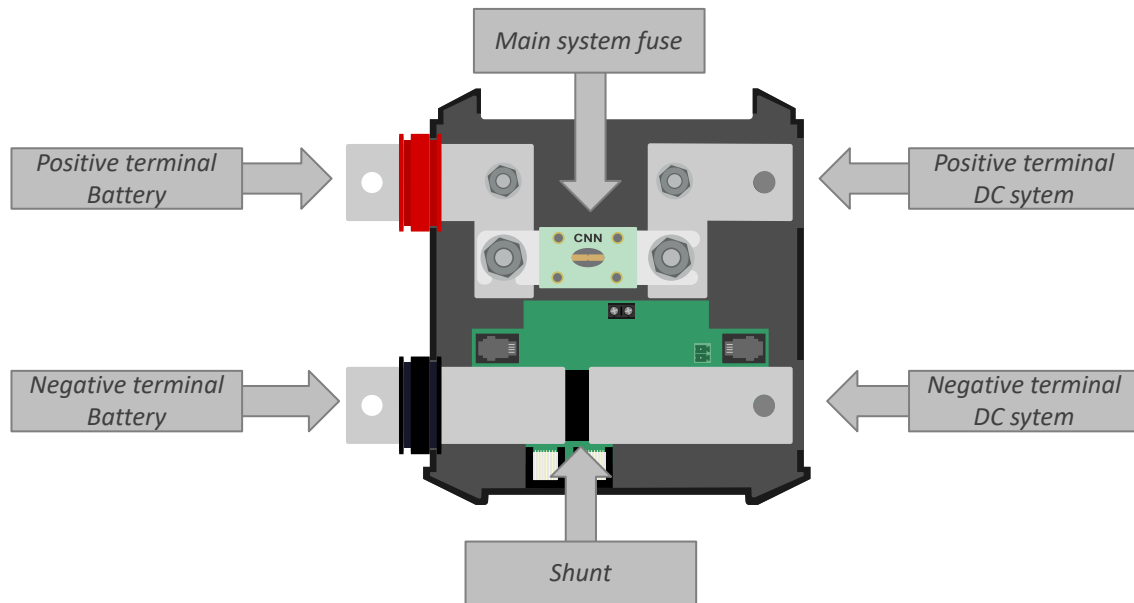

The Internal physical parts of the Lynx Shunt VE.can

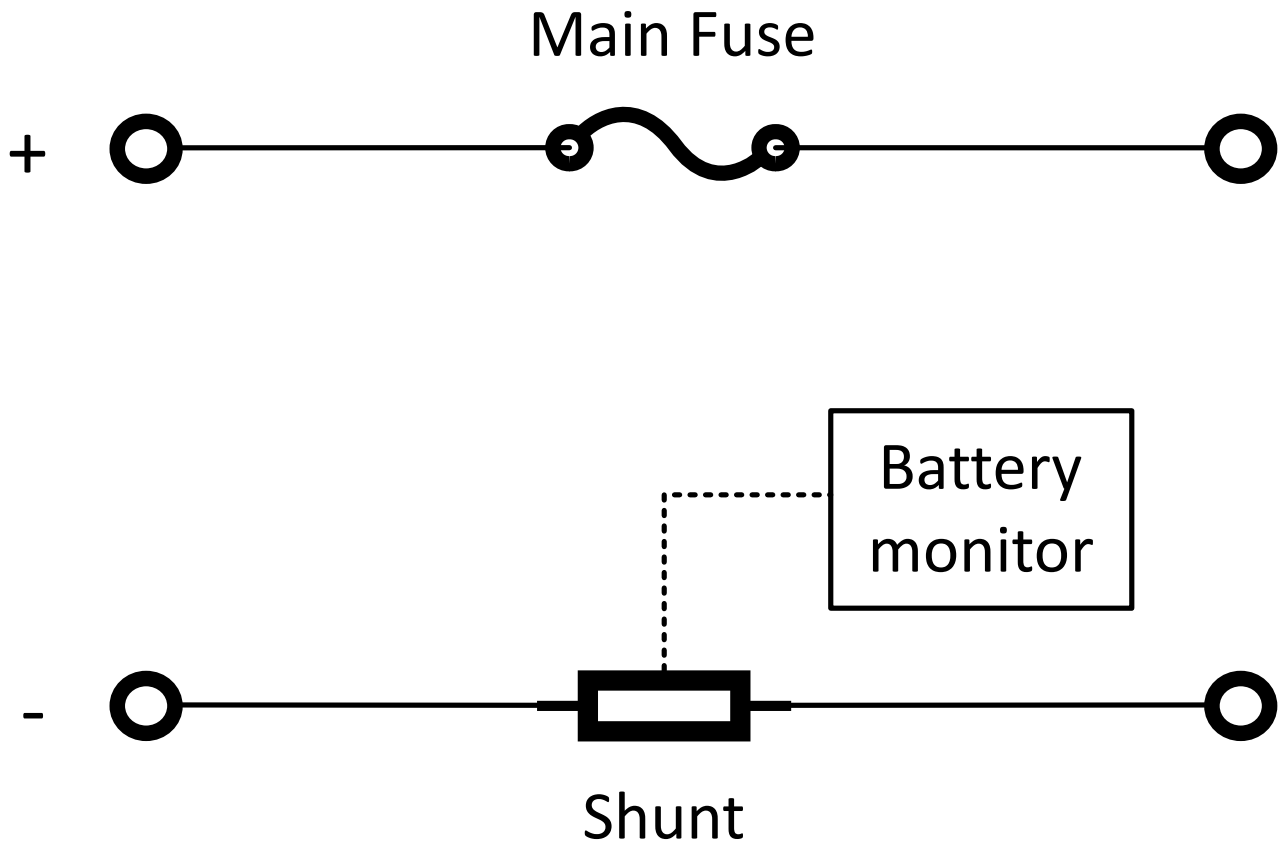

The internal wiring diagram of the Lynx Shunt VE.Can

3.2. Main fuse

The Lynx Shunt houses the main system fuse.

The fuse is being monitored by the Lynx Shunt VE.Can and, if the fuse blows, the power LED turns red and an alarm message is sent to the GX device.

The relay can be driven by the blown fuse parameter.

3.3. Battery Monitor (shunt)

The Lynx Shunt VE.Can battery monitor operates in a similar fashion as the other [Victron Energy battery monitors](#). It contains a shunt and battery monitor electronics.

Readout of the battery monitor data is via a GX device or the VRM portal.

3.4. Alarm relay Lynx Shunt VE.Can

The Lynx Shunt VE.Can has an alarm relay. This relay can be programmed via the GX device to open or close using the following parameters:

- Battery State of charge
- Battery voltage
- Battery temperature
- Fuse blown

The alarm relay can, for example, be used to start or stop a generator based on battery state of charge or battery voltage. The alarm messages that are sent to the GX device or to the VRM portal are programmable in a similar fashion.

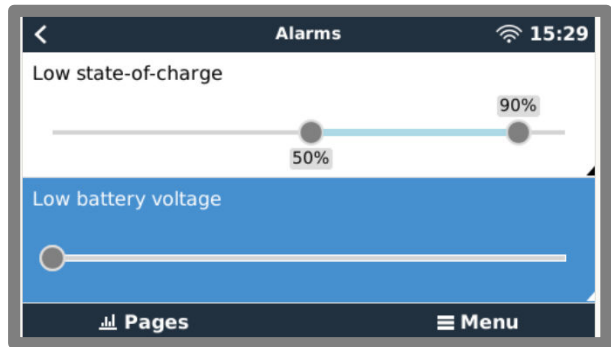
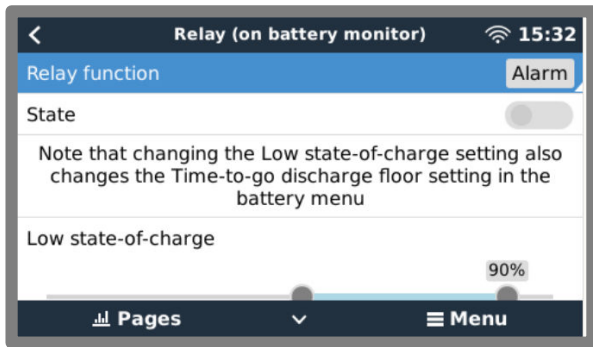

GX device settings alarm relay and alarm messages

3.5. Temperature sensor

The temperature sensor is an optional extra to measure the battery temperature. If used, the Lynx Shunt VE.Can will measure the temperature of the battery and can be used to drive the Lynx Shunt VE.Can alarm relay.

The temperature data or temperature alarms will also be sent to the GX device and from there to the VRM portal. On the VRM portal the temperature data is logged and can be accessed.

Figure 1. VRM data logging battery temperature example

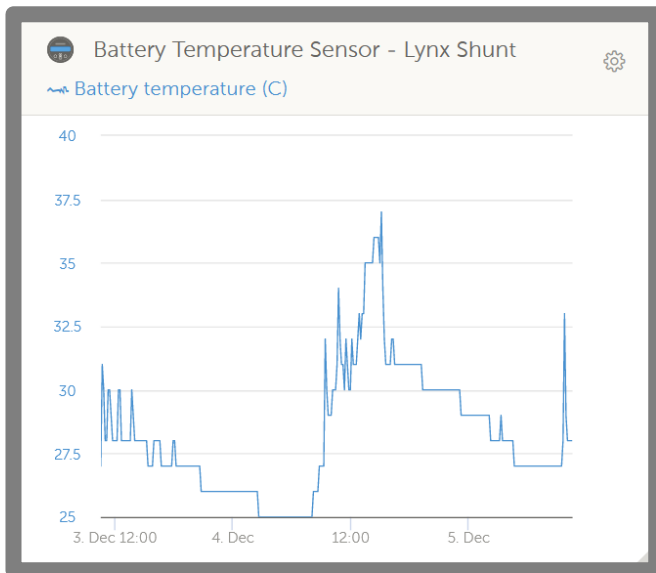

Example of VRM battery temperature data logging

4. Communication and interfacing

4.1. GX Device

The Lynx Smart BMS can be connected to a GX device via VE.Can. The GX device will show all measured parameters, operational state, battery SoC and alarms.

4.2. NMEA2000

Communication with a NMEA2000 network can be established via the Lynx Shunt VE.Can VE.Can connection together with a [VE.Can to NMEA2000 micro-C male cable](#).

Supported NMEA 2000 PGNs:

Product Information – PGN 126996

DC detailed Status – PGN 127506

DC/Battery Status – PGN 127508

Switch Bank Status - PGN 127501

- Status 1: Relay
- Status 2: Alarm
- Status 3: Battery voltage low
- Status 4: Battery voltage high

Class and function:

N2K device class: Electrical generation

N2K device function : Battery

For more information see the [NMEA2000 & MFD integration guide](#).

5. System Design

5.1. Lynx distribution system parts

A Lynx distribution system consists of a single Lynx Shunt VE.Can module.

Then, single, multiple or a combination of Lynx Distributor modules and/or Lynx Power In modules are added.

Together they form a continuous negative and positive busbar with DC connections and, depending on the configuration, integrated fuses, a battery monitor and/or lithium battery management.

5.1.1. Interconnecting Lynx modules

Each Lynx module can connect to other Lynx modules on the left side (M8 hole) and on the right side (M8 bolt).

If the Lynx module is the first in line, the last in line or is used by itself, it is possible to connect batteries, loads or chargers directly to these connections. However, we do not generally recommend this because additional insulation and fusing is needed.

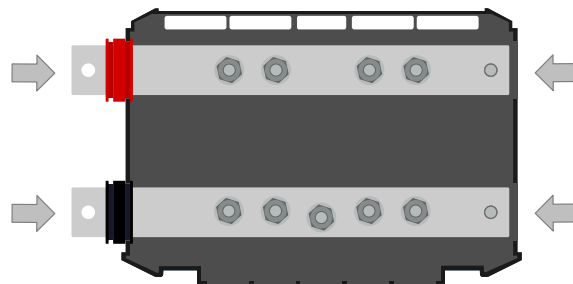

Lynx connections: The arrows indicate where the other Lynx modules can connect

The example below shows a Lynx system consisting out of a Lynx Power In, Lynx Shunt VE.Can and Lynx Distributor. Together they form a continuous busbar, with un-fused battery connections, battery monitor, main system fuse and fused load connections.

Figure 2. Example of Interconnected Lynx modules without their covers (Lynx Shunt VE.Can)

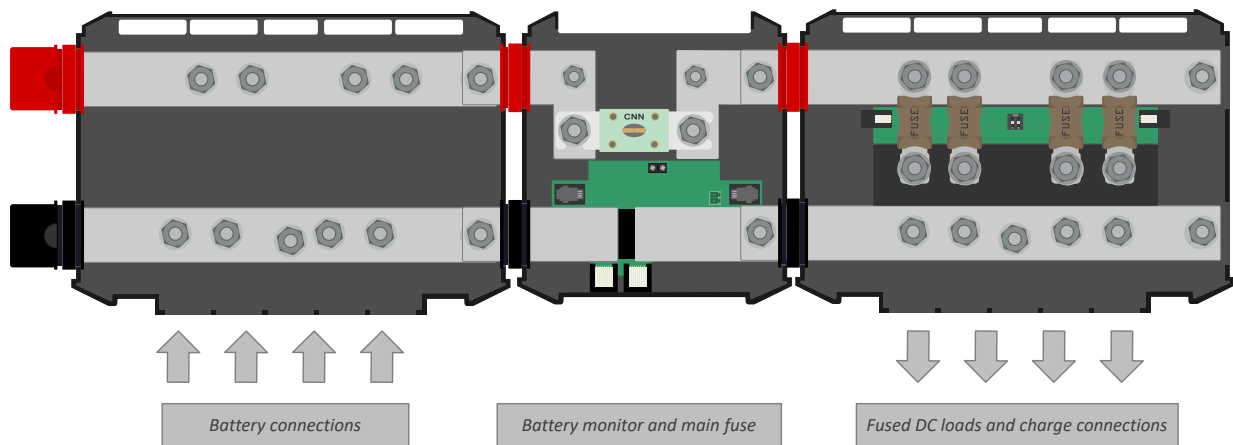

Interconnected Lynx modules: Lynx Power In, Lynx Shunt VE.Can and Lynx Distributor

5.1.2. Orientation of Lynx modules

If the Lynx System contains a Lynx Shunt VE.Can, the batteries always have to be connected to the left side of the Lynx System and the rest of the DC system (loads and chargers) connect to the right side. This, so the battery state of charge can be correctly calculated.

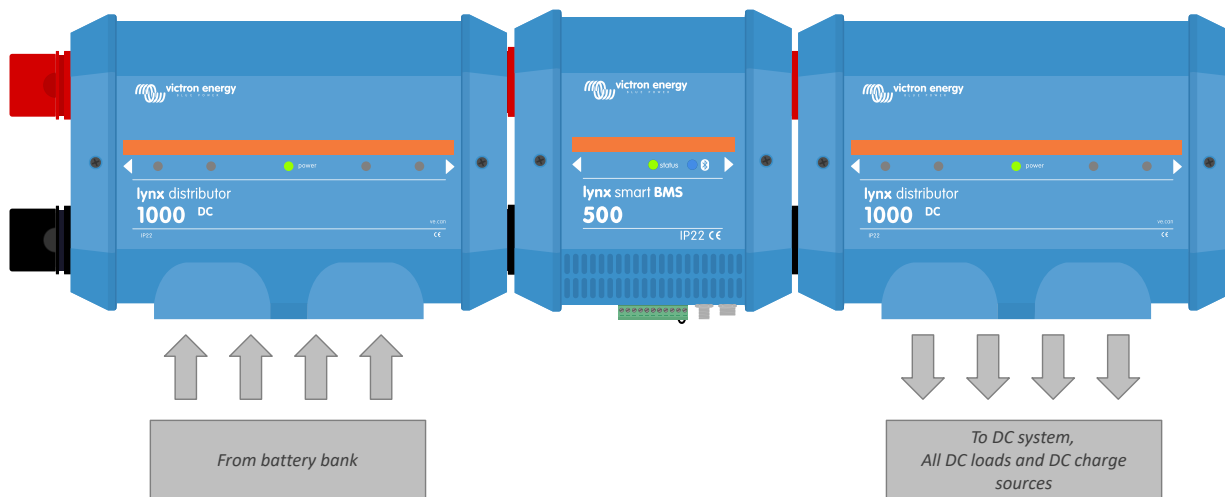

Example of Lynx module orientation: the batteries connect to the left side and all loads and chargers connect on the right side

The Lynx modules can be mounted in any orientation. Should they be mounted upside down, so that the text on the front of the units is upside down as well, use the special stickers are included with each Lynx module, so that the text is orientated the correct way.

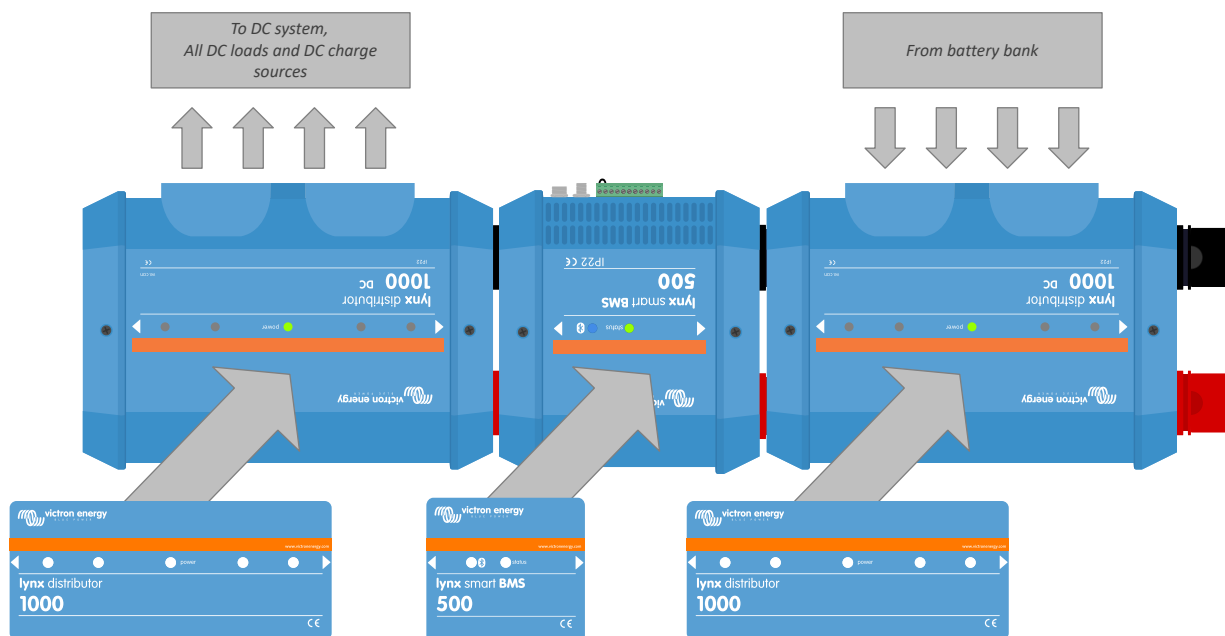

Example of Lynx modules mounted upside down: the batteries connect to the right side, all loads and chargers connect to the left side and the upside down stickers are affixed.

5.1.3. System example - Lynx Shunt VE.Can, Lynx Power In, Lynx Distributor and lead acid batteries

This system contains the following components:

- Lynx Power In with 4 paralleled 12V lead acid batteries.
- Identical cable lengths for each battery.
- Lynx Shunt VE.Can with main system fuse and battery monitor.
- Lynx Distributor with fused connections for inverter/charger(s), loads and chargers. Note that additional modules can be added if more connections are needed.
- CCGX (or other GX device) to read out the battery monitor data.

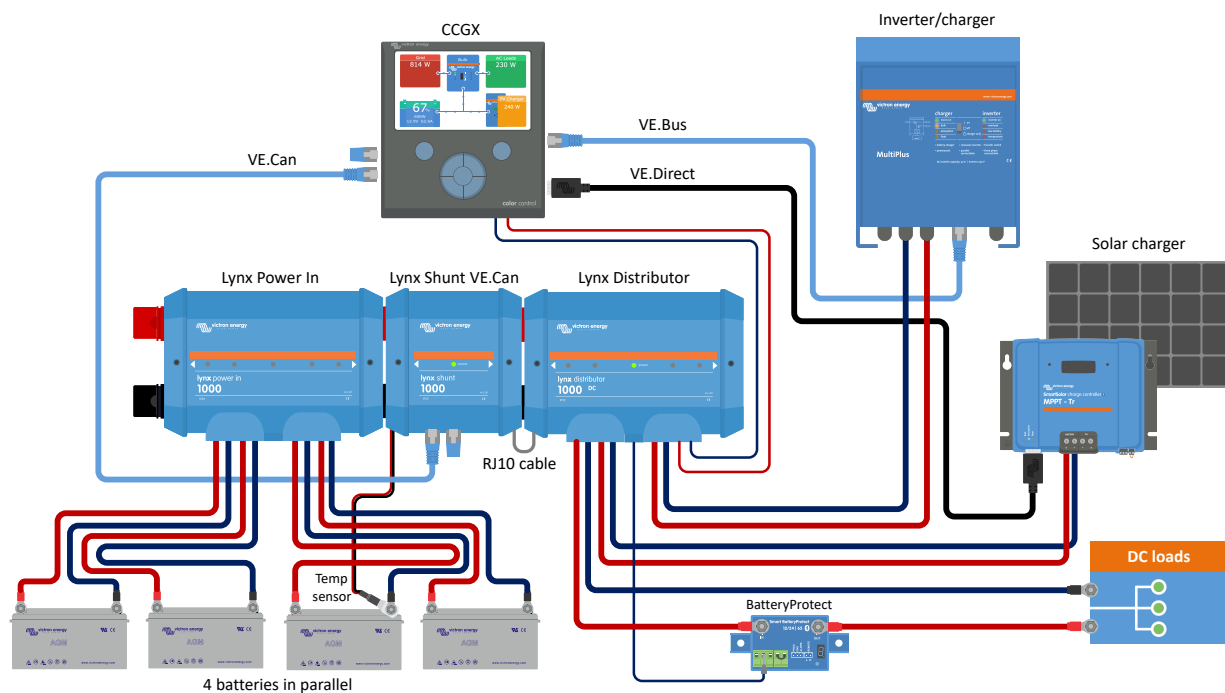

System with Lynx Shunt VE.Can, lead acid batteries, a Lynx Shunt VE.Can and a Lynx Distributor

5.2. System sizing

5.2.1. Current rating Lynx modules

The Lynx Distributor, Lynx Shunt VE.Can and the Lynx Power In are rated for a nominal current of 1000A, for 12, 24 or 48 System voltages.

To give an idea of how much power the Lynx modules are rated at different voltages, see below table. The power rating will give you an indication how big the connected inverter/charger system can be. Keep in mind that if inverters or inverter/chargers are used, both the AC and DC system will be powered from the batteries. Also be aware that a Lynx Smart BMS or a Lynx Ion (now discontinued) can have a lower current rating.

Table 1. Power rating Lynx modules

	12V	24V	48V
1000A	12kW	24kW	48kW

5.2.2. Fusing

The Lynx VE.Can has a space for a main fuse. This space has been designed to fit a CNN fuse. A 325A/80V fuse is available from Victron Energy (CIP140325000-Fuse CNN 325A/80V for Lynx shunt" or use another [CNN fuse by Littlefuse](#). Although the distance between the fuse mounting bolts is designed for a CNN fuse but it might also be possible to fit other fuse types in this space. The fuse mounting bolts are M8 and their centres are 63mm apart.

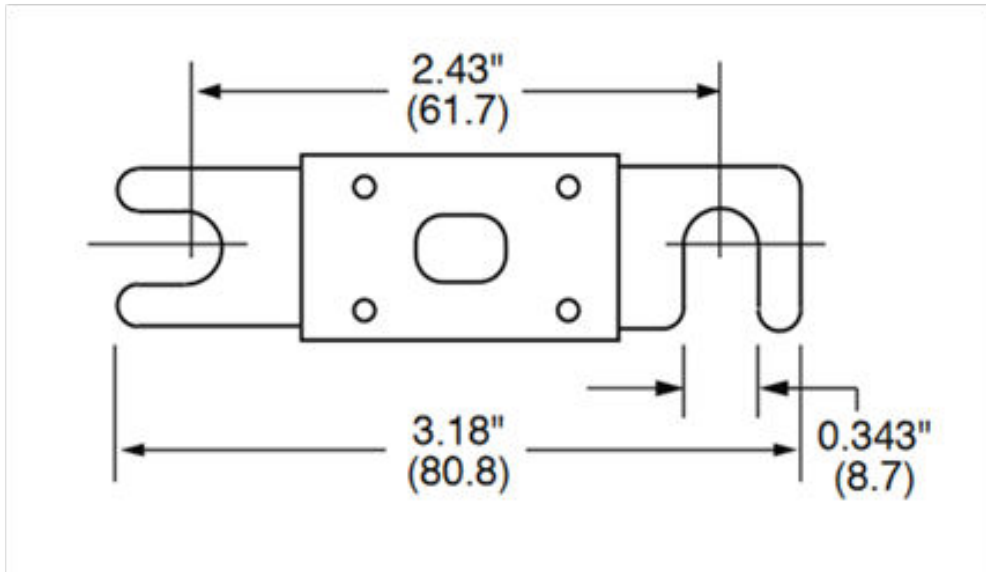

CNN fuse dimensions in inches (mm)

Always use fuses with the correct voltage and current rating. Match the fuse rating to the maximum voltages and currents that potentially can occur in the fused circuit. For more information on fuse ratings and fuse current calculations see the [Wiring Unlimited book](#).



The total value of the fuses of all circuits should not be more than the current rating of the Lynx module, or the Lynx model with the lowest current rating in case of multiple Lynx modules are used.

5.2.3. Cabling

The current rating of the wires or cables used to connect the Lynx Shunt VE.Can to batteries and/or the DC loads has to be rated for the maximum currents that can occur in the connected circuits. Use cabling with a sufficient core surface area to match the maximum current rating of the circuit.

For more information on cabling and cable thickness calculations see the [Wiring Unlimited book](#).

6. Installation

6.1. Mechanical connections

6.1.1. Lynx module connection features

The Lynx module can be opened up by unscrewing 2 cover screws.

The contacts on the left side are covered by a removable rubber sleeve.

Red is the positive busbar and black is the negative busbar.

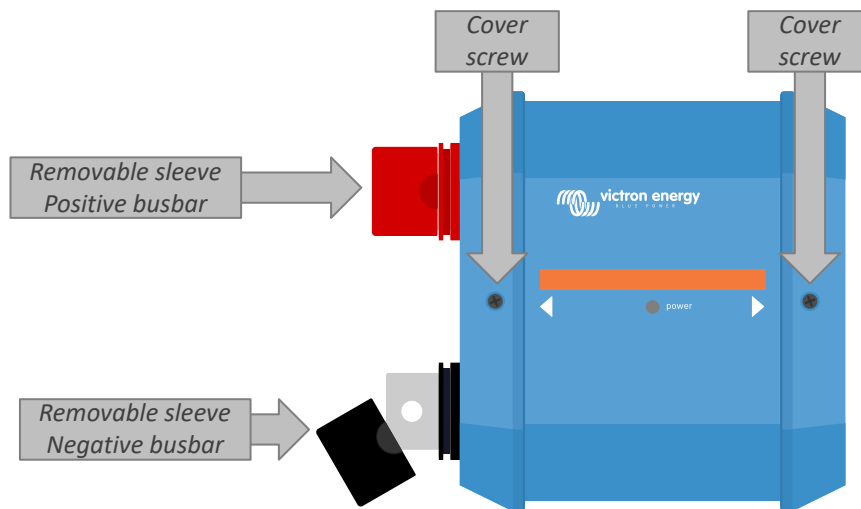

Location of front cover screws and the removable sleeves

6.1.2. Mounting and interconnecting Lynx modules

This paragraph explains how to attach several Lynx modules to each other and how to mount the Lynx assembly into its final location.

For a mechanical drawing of the housing, with dimensions and the location of the mounting holes, see the appendix of this manual.

These are the points to take into consideration when interconnecting and mounting Lynx modules:

- If Lynx modules are going to be connected to the right and if the Lynx module is fitted with a plastic barrier on the right side, remove the black plastic barrier. If the Lynx module is located as the most right module, leave the black plastic barrier in place.
- If Lynx modules are going to be connected to the left, remove the red and black rubber sleeves. If the Lynx module is located as the most left module, leave the red and black rubber sleeves in place.
- If the Lynx system contains a Lynx Smart BMS or Lynx Shunt VE.Can, the left side is the battery side and the right side is the DC system side.
- Connect all Lynx modules to each other using the M8 holes and bolts on the left and right. Take care that the modules correctly slot into the rubber joiner recesses.
- Place the washer, spring washer and nut on the bolts and tighten the bolts using a torque of 14Nm.
- Mount the Lynx assembly in its final location using the 5mm mounting holes.

Figure 3. Connection sequence when connecting two Lynx modules

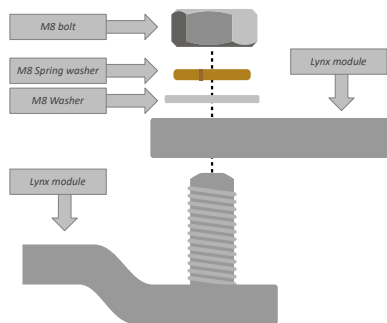

Correct placement of the M8 washer, spring washer and nut.

6.2. Electrical connections

6.2.1. Connect DC wires

This chapter might not apply if the Lynx module is connected to other Lynx modules, like can be the case for the Lynx Smart BMS or the Lynx Shunt VE.Can.

For all DC connections the following applies:

- All cables and wires connected to the Lynx module need to have been fitted with M8 cable lugs.
- Pay attention to the correct placement of the cable lug, washer, spring washer and nut on each bolt when attaching the cable to the bolt.
- Tighten the nuts with a torque moment of 14Nm.

Figure 4. Correct mounting sequence DC wires

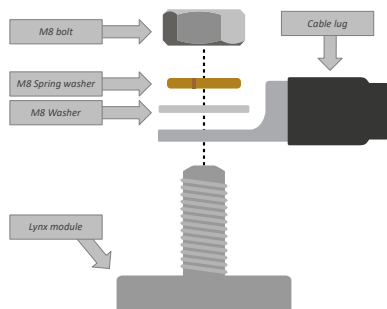

Correct placement of the M8 Cable lug, washer, spring washer and nut

6.2.2. Connect the temperature sensor

An optional battery temperature sensor can be connected to the green terminal with the + and - symbol.

The connector can be removed from the terminal, for easy connection.

The temperature sensor is polarity sensitive. Connect the black wire to the - terminal and the red wire to the + terminal.

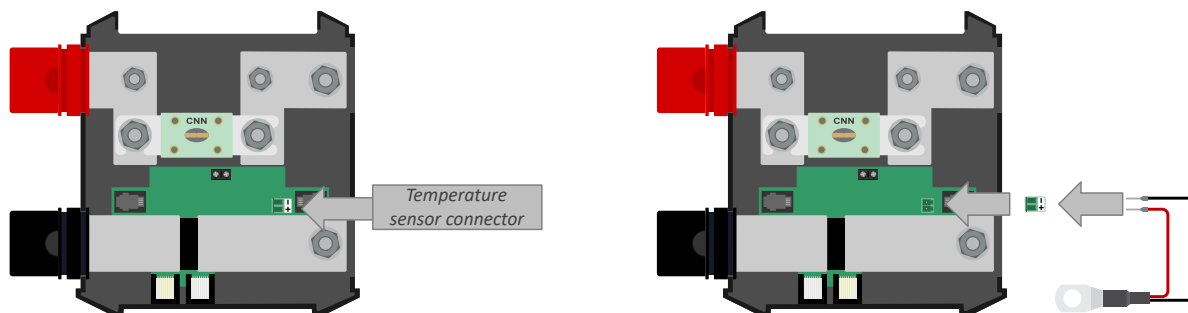

Temperature sensor connection Lynx Shunt VE.Can

6.2.3. Connect the alarm relay

The alarm relay connector is the black 2-way connector. See below image for its location.

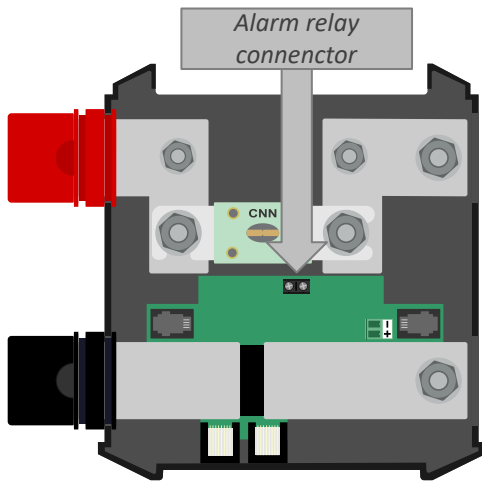

Alarm relay connection Lynx Shunt VE.Can

6.2.4. Place main fuse

Place the main fuse in the Lynx Shunt VE.can.

Be aware that if the positive bus is already powered, the moment the fuse is placed the system will become live.

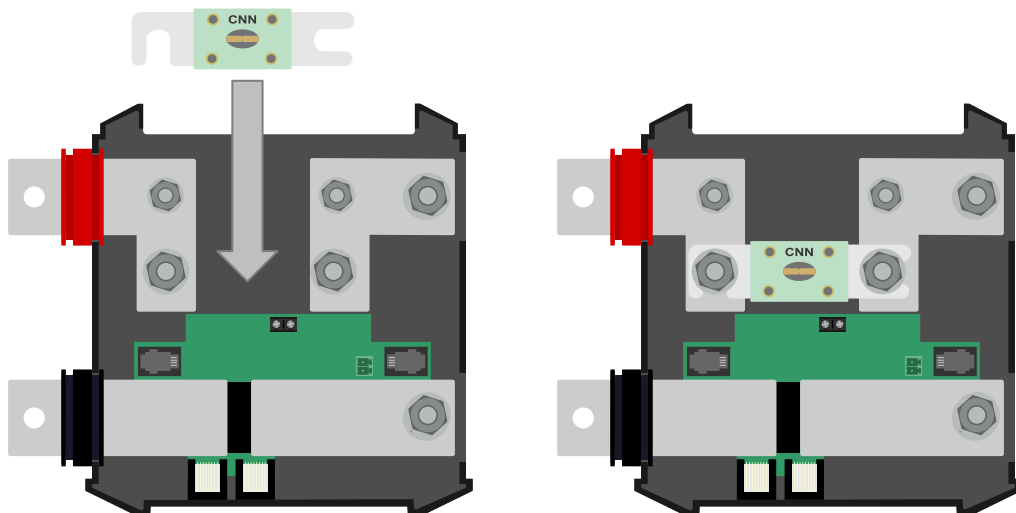

Placing the CNN fuse in the Lynx Shunt VE.Can

6.2.5. Connect the GX device

Connect the Lynx Shunt VE.Can VE.Can port to the GX device VE.Can port using a [RJ45 cable](#).

Multiple VE.Can devices can be interconnected, but make sure that the first and the last VE.Can device both have a [VE.Can RJ45 terminator](#) installed.

Power the GX device from the output of the Lynx Shunt VE.Can or a Lynx distributor connected to the output of the Lynx Shunt VE.Can.

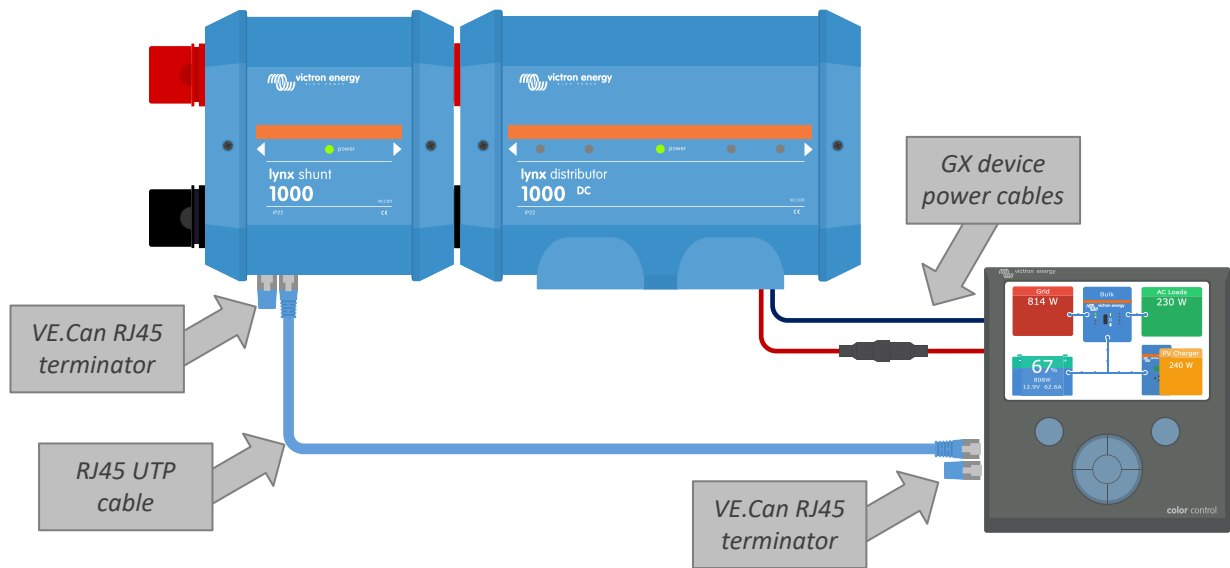

Wiring example Lynx Shunt VE.Can and GX device

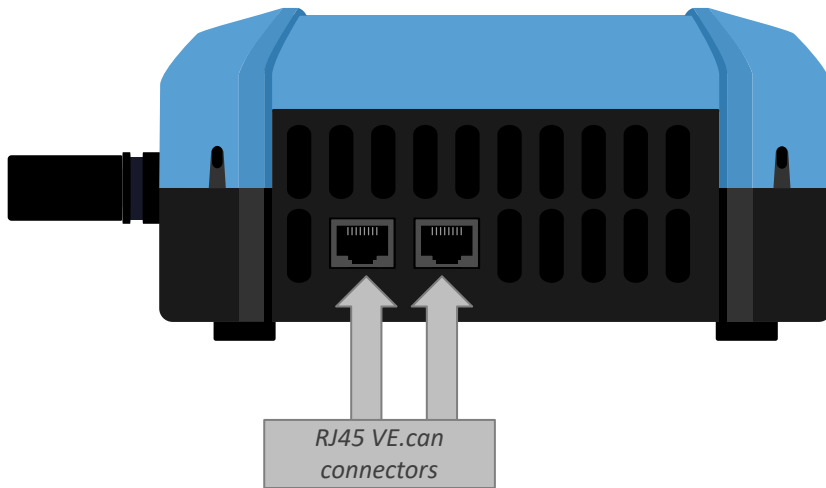

Location VE.Can connectors Lynx Shunt VE.Can

6.3. Configuration and settings

6.3.1. Settings Lynx Shunt VE.Can

Once powered up and connected to a GX device, navigate to the Lynx Shunt VE.Can settings menu on the GX device to make and change settings.

Most settings can be left to their default values, but there are a few essential settings to make by your own :

- Set the battery capacity.
- If lithium batteries are used, specific battery monitor settings are needed. Refer to the battery monitor settings chapter.
- If the alarm relay is used, set the alarm relay parameters.

For a full overview and an explanation of all battery monitor settings, refer to the battery monitor setting chapter

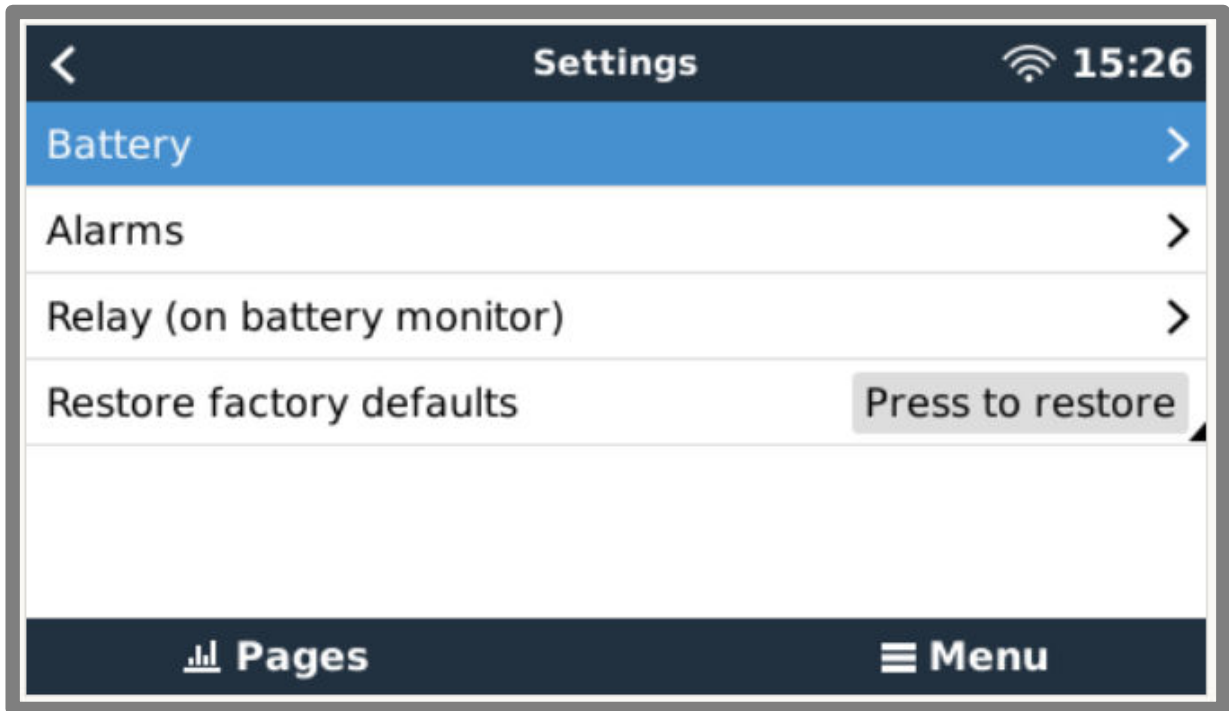

Making Lynx Shunt VE.Can settings using a GX device

7. Commissioning the Lynx Shunt VE.Can

Commissioning sequence:

- Check polarity of all DC cables.
- Check cross sectional area of all DC cables.
- Check if all cable lugs have been crimped correctly.
- Check if all cable connections are tight (don't exceed maximum torque).
- Tug slightly on each battery cable to check if the connections are tight and if the cable lugs have been crimped correctly.
- Turn a load on and see if the battery monitor displays the correct current polarity.
- Fully charge the battery, so that the battery monitor synchronises.

8. Operation Lynx Shunt VE.Can

The Lynx Shunt VE.Can is active as soon as power is applied to the input (battery side) of the Lynx Shunt VE.Can.

The Lynx Shunt VE.Can monitors the state of charge of the battery and monitors the fuse.

LED indications

The basic Lynx Shunt VE.Can operation status is displayed via its power LED. See below table for the information displayed via the Power LED.

Table 2. Lynx Shunt VE.Can operational status

Power LED	Description
Solid green	Lynx system is OK
Solid red	Main fuse is blown
Solid orange	An alarm is active
Blink red	Hardware failure
Blink red/green	Calibration error
Blink green fast	Initializing
Blink green slow	Firmware update
Blink orange	Firmware failure

GX device indications

Operational data is displayed on the connected GX device. This includes data such as battery voltage, battery current, state of charge and so on.

See below table of all monitored parameters.

Table 3. Lynx Shunt VE.Can operational data

Parameter	Description	Unit
Battery voltage	Displays the voltage of the battery	Volts
Battery current	Displays the current that flows into or out of the battery	Amps
Battery energy	Displays the power that flows into or out of the battery	Watt
State of charge	The state of charge indicates the percentage of the battery capacity that is still available for consumption. A full battery will show 100 %, and an empty battery will display 0 %. This is the best way to see when the batteries need to be recharged	Percentage
Consumed AmpHours	Displays the energy consumed since the battery was last fully charged	AmpHours
Time to go	Displays the estimated time, based on the current load, before the batteries need to be recharged.	Hours and minutes
Relay state	Displays the state of the relay. On means that the relay contacts are closed, off means that the relay contacts are open.	On/off
Alarm state	Displays if an alarm is active or not	Ok/Alarm
Battery temperature	Displays the battery temperature	Degrees Celsius
Firmware version	The Firmware version of this device	Number

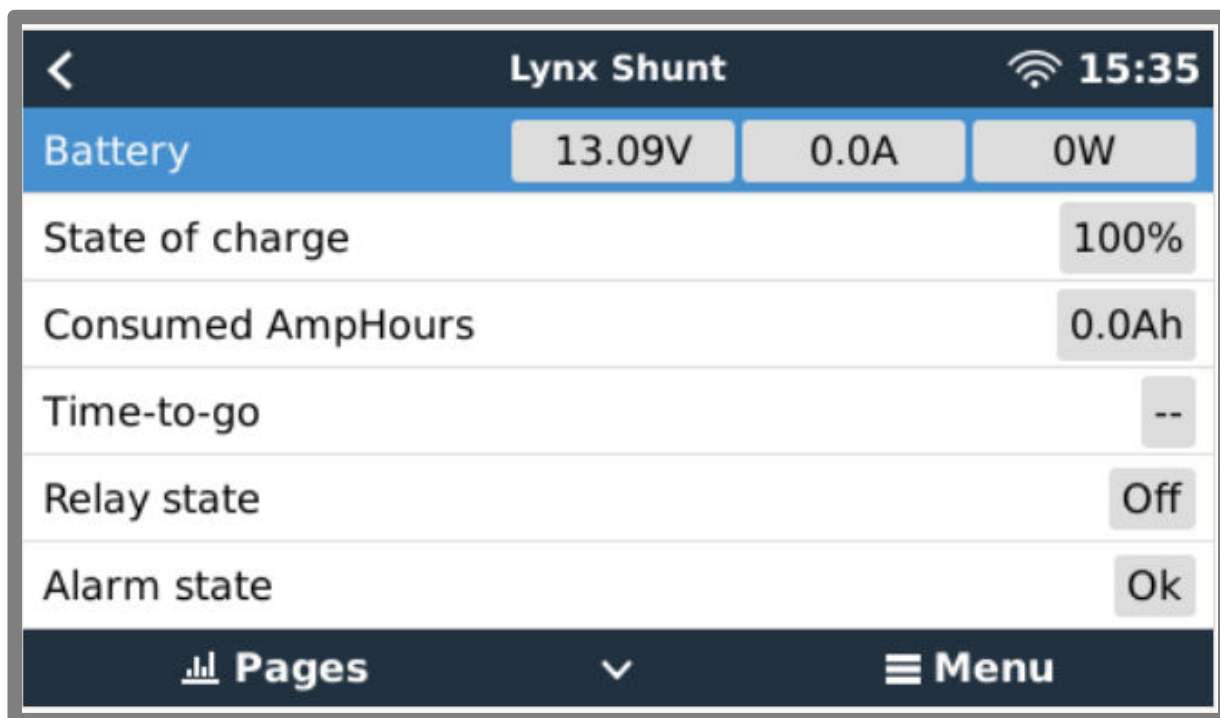

GX device displaying Lynx Shunt VE.Can operational data

Historical data

The Lynx Shunt VE.Can keeps track of historical data providing information about the state and the past use of the batteries. See below table of all monitored parameters.

Table 4. Historical data Lynx Shunt VE.Can

Parameter	Description	Unit
Deepest discharge	The deepest discharge in Ah.	AmpHour
Last discharge	The depth of the last discharge in Ah. This value will be reset to 0 when the State of Charge reaches 100 % again	AmpHour
Average discharge	The average discharge over all the cycles counted.	AmpHour
Total charge cycles	Every time the battery is discharged below 65 % of its rated capacity and charged back to at least 90 %, one cycle is counted.	Number
Number of full discharges	The number of times the battery has been discharged to a 0% state of charge.	Number
Cumulative Ah drawn	Records the total energy consumed over all charge cycles.	AmpHour
Minimum voltage	Lowest voltage measured.	Voltage
Maximum voltage	Highest voltage measured.	Voltage
Time since last full charge	The time that has elapsed since the battery was last fully charged.	Seconds
Synchronisation count	The number of times the Lynx Shunt has automatically synchronised.	Number
Low voltage alarms	The number of times a low voltage alarm has occurred.	Number
High voltage alarms	The number of times a high voltage alarm has occurred.	Number
Clear history	Press to clear all historic data.	Press to clear

Alarms and the alarm relay

In case of an alarm, a message is sent to the GX device and the VRM portal and/or the alarm relay is activated.

The alarm conditions are:

- Battery state of charge
- Battery voltage
- Battery temperature
- Main fuse blown

9. Battery monitor settings

This chapter explains all battery monitor settings. In addition to this we also have a video available explaining these settings and how they interact with each other to achieve accurate battery monitoring for both lead-acid and lithium batteries.

https://www.youtube.com/embed/mEN15Z_S4kE

9.1. Battery capacity

This parameter is used to tell the battery monitor how big the battery is. This setting should already have been done during the initial installation.

The setting is the battery capacity in Amp hours (Ah).

For more information on Battery capacity and Peukert exponent see chapter [Battery capacity and Peukert exponent \[22\]](#)

Default setting	Range	Step size
200 Ah	1 - 9999 Ah	1 Ah

9.2. Charged voltage

The battery voltage must be above this voltage level to consider the battery as fully charged. As soon as the battery monitor detects that the voltage of the battery has reached the "charged voltage" and the current has dropped below the "tail current" for a certain amount of time, the battery monitor will set the state of charge to 100%.

Default setting	Range	Step size

The "charged voltage" parameter should be set to 0.2V or 0.3V below the float voltage of the charger.

Table 5. Recommended settings for lead acid batteries:

Nominal battery voltage	Charged voltage setting
12V	13.2V
24V	26.4V
36V	39.6V
48V	52.8V

9.3. Tail current

The battery is considered as "fully charged" once the charge current has dropped to less than the set "Tail current" parameter. The "Tail current" parameter is expressed as a percentage of the battery capacity.

Remark: Some battery chargers stop charging when the current drops below a set threshold. In these cases, the tail current must be set higher than this threshold.

As soon as the battery monitor detects that the voltage of the battery has reached the set "Charged voltage" parameter and the current has dropped below the "Tail current" for a certain amount of time, the battery monitor will set the state of charge to 100%.

Default setting	Range	Step size
4.00%	0.50 - 10.00%	0.1%

9.4. Charged detection time

This is the time the "Charged voltage" and "Tail current" must be met in order to consider the battery fully charged.

Default setting	Range	Step size
3 minutes	0 - 100 minutes	1 minute

9.5. Peukert exponent

Set the Peukert exponent according to the battery specification sheet. If the Peukert exponent is unknown, set it at 1.25 for lead-acid batteries and set it at 1.05 for lithium batteries. A value of 1.00 disables the Peukert compensation. The Peukert value for lead-

acid batteries can be calculated. For more information on the Peukert calculation, battery capacity and Peukert exponent see the Peukert exponent chapter.

Default setting	Range	Step size
1.25	1.00 - 1.50	0.01

9.6. Charge efficiency factor

The “Charge Efficiency Factor” compensates for the capacity (Ah) losses during charging. A setting of 100% means that there are no losses.

A charge efficiency of 95% means that 10Ah must be transferred to the battery to get 9.5Ah actually stored in the battery. The charge efficiency of a battery depends on battery type, age and usage. The battery monitor takes this phenomenon into account with the charge efficiency factor.

Default setting	Range	Step size
95%	50 - 100%	1%

The charge efficiency of a lead acid battery is almost 100% as long as no gas generation takes place. Gassing means that part of the charge current is not transformed into chemical energy, which is stored in the plates of the battery, but is used to decompose water into oxygen and hydrogen gas (highly explosive!). The energy stored in the plates can be retrieved during the next discharge, whereas the energy used to decompose water is lost. Gassing can easily be observed in flooded batteries. Please note that the ‘oxygen only’ end of the charge phase of sealed (VRLA) gel and AGM batteries also results in a reduced charge efficiency.

9.7. Current threshold

When the current measured falls below the “Current threshold” value it will be considered zero. The “Current threshold” is used to cancel out very small currents that can negatively affect the long-term state of charge readout in noisy environments. For example, if the actual long-term current is 0.0A and, due to injected noise or small offsets, the battery monitor measures 0.05A the battery monitor might, in the long term, incorrectly indicate that the battery is empty or will need to be recharged. When the current threshold in this example is set to 0.1A, the battery monitor calculates with 0.0A so that errors are eliminated.

A value of 0.0A disables this function.

Default setting	Range	Step size
0.10 A	0.00 - 2.00 A	0.01 A

9.8. Time-to-go averaging period

The time-to-go averaging period specifies the time window (in minutes) that the moving averaging filter works. A value of 0 disables the filter and gives an instantaneous (real-time) readout. However, the displayed “Time remaining” value may fluctuate heavily. Selecting the longest time, 12 minutes, will ensure that only long-term load fluctuations are included in the “Time remaining” calculations.

Default setting	Range	Step size
3 minutes	0.. 12 minutes	1 minute

9.9. Synchronise SoC to 100%

This option can be used to manually synchronise the battery monitor. Press the “Synchronise” button to synchronise the Lynx Shunt VE.Can to 100%.

9.10. Zero current calibration

This option can be used to calibrate the zero reading if the battery monitor reads a non-zero current even when there is no load and the battery is not being charged.

A zero current calibration is (almost) never needed. Only perform this procedure in case the battery monitor shows a current while you are absolutely sure that there is no actual current flowing. The only way to be sure of this, is to physically disconnect all wires and cables connected to the side of the shunt. Do this by unscrewing the shunt bolt and remove all cables and wires from that side of the shunt. The alternative, which is switching off loads or chargers, is NOT accurate enough as it does not eliminate small standby currents.

10. Battery capacity and Peukert exponent

Battery capacity is expressed in Amp hour (Ah) and indicates how much current a battery can supply over time. For example, if a 100Ah battery is being discharged with a constant current of 5A, the battery will be totally discharged in 20 hours.

The rate at which a battery is being discharged is expressed as the C rating. The C rating indicates how many hours a battery with a given capacity will last. 1C is the 1h rate and means that the discharge current will discharge the entire battery in 1 hour. For a battery with a capacity of 100Ah, this equates to a discharge current of 100A. A 5C rate for this battery would be 500A for 12 minutes (1/5 hours), and a C5 rate would be 20A for 5 hours.



There are two ways of expressing the C rating of a battery. Either with a number before the C or with a number after the C.

For example:

- 5C is the same as C0.5
- 1C is the same as C1
- 0.2C is the same as C2

The capacity of a battery depends on the rate of discharge. The faster the rate of discharge, the less capacity will be available. The relation between slow or fast discharge can be calculated by Peukert's law and is expressed by the Peukert exponent. Some battery chemistries suffer more from this phenomenon than others. Lead acid are more affected by this than lithium batteries are. The battery monitor takes this phenomenon into account with Peukert exponent.

Discharge rate example

A lead acid battery is rated at 100Ah at C20, this means that this battery can deliver a total current of 100A over 20 hours at a rate of 5A per hour. $C20 = 100Ah (5 \times 20 = 100)$.

When the same 100Ah battery is discharged completely in two hours, its capacity is greatly reduced. Because of the higher rate of discharge, it may only give $C2 = 56Ah$.

Peukert's formula

The value which can be adjusted in Peukert's formula is the exponent n: see the formula below.

In the battery monitor the Peukert exponent can be adjusted from 1.00 to 1.50. The higher the Peukert exponent the faster the effective capacity 'shrinks' with increasing discharge rate. An ideal (theoretical) battery has a Peukert exponent of 1.00 and has a fixed capacity regardless of the size of the discharge current. The default setting in the battery monitor for the Peukert exponent is 1.25. This is an acceptable average value for most lead acid batteries.

Peukert's equation is stated below:

$C_p = I^n \times t$ Where Peukert's exponent n is:

$$n = \frac{\log t_2 - \log t_1}{\log I_1 - \log I_2}$$

To calculate the Peukert exponent you will need two rated battery capacities. This is usually the 20h discharge rate and the 5h rate, but can also be the 10h and 5h, or the 20h and the 10h rate. Ideally use a low discharge rating together with a substantially higher rating. Battery capacity ratings can be found in the battery datasheet. If in doubt contact your battery supplier.

Calculation example using the 5h and the 20h rating

The C5 rating is 75Ah. The t1 rating is 5h and I1 is calculated:

$$I_1 = \frac{75Ah}{5h} = 25A$$

The C20 rating is 100Ah. The t2 rating is 20h and I2 is calculated:

$$I_2 = \frac{100Ah}{20h} = 5A$$

The Peukert exponent is:

$$n = \frac{\log 20 - \log 5}{\log 15 - \log 5} = 1.26$$

A Peukert calculator is available at <http://www.victronenergy.com/support-and-downloads/software>

Please note that the Peukert exponent is no more than a rough approximation of reality, and that at very high currents, batteries will give even less capacity than predicted from a fixed exponent. We recommend not to change the default value in the battery monitor, except in case of lithium batteries.

11. Troubleshooting and Support

Consult this chapter in case of unexpected behaviour or if you suspect a product fault.

The correct troubleshooting and support process is to first consult the common issues as described in this chapter.

Should this fail to resolve the issue, contact the point of purchase for technical support. If the point of purchase is unknown, refer to the [Victron Energy Support webpage](#).

11.1. Cabling issues

Cables heat up

This can be caused by a wiring or connection issue. Check the following:

- Check if all cable connections are tightened with a torque moment of 14Nm.
- Check if all fuse connections are tightened with a torque moment of 14Nm.
- Check if the surface area of the cable core is large enough for the current through that cable.
- Check if all cable lugs have been crimped correctly and are tight enough.

Other cabling issues

For additional information about issues that can arise from bad or incorrect cabling, cable connections or wiring of battery banks refer to the [Wiring Unlimited Book](#).

11.2. Main fuse issues

For additional information about issue that can arise from an incorrect fuse rating or type refer to the [Wiring Unlimited Book](#).

Fuse blows as soon as a new fuse is installed

Check the DC circuit that is attached to the fuse for the following:

Check if there is a short circuit.

Check if there is a malfunctioning load.

Check if the current in the circuit is not larger than the fuse rating.

11.3. Battery monitor issues

11.3.1. Charge and discharge current are inverted

The charge current should be shown as a positive value. For example: 1.45A.

The discharge current should be shown as a negative value. For example: -1.45A.

If the charge and discharge currents are reversed, the negative power cables on the battery monitor must be swapped.

11.3.2. Incomplete current reading

The negatives of all the loads and the charge sources in the system must be connected to the system minus side of the .

If the negative of a load or a charge source is connected directly to the negative battery terminal or the “battery minus” side on the , their current will not flow through the battery monitor and will be excluded from the overall current reading and the state of charge reading.

The SmartShunt will display a higher state of charge than the actual state of charge of the battery.

11.3.3. There is a current reading while no current flows

If there is a current reading while no current is flowing through the , perform a [zero current calibration \[21\]](#) while all loads are turned off or set the [current threshold \[21\]](#) .

11.3.4. Incorrect state of charge reading

An incorrect state of charge can be caused by a variety of reasons.

Incorrect battery settings

The following parameter(s) will have an effect on the state of charge calculations if they have been set up incorrectly:

- Battery capacity
- Peukert exponent
- Charge efficiency factor

Incorrect state of charge due to a synchronisation issue:

The state of charge is a calculated value and will need to be reset (synchronised) every now and then.

The synchronisation process is automatic will be performed each time the battery is fully charged. The battery monitor determines that battery is fully charged when all 3 "charged" conditions have been met. The "charged" conditions are:

- Charged voltage (Voltage)
- Tail current (% of battery capacity)
- Charge detection time (minutes)

Practical example the conditions that need to be met before a synchronisation will take place:

- The battery voltage has to be above 13.8V
- The charge current has to be less than $0.04 \times$ battery capacity (Ah). For a 200Ah battery this is $0.04 \times 200 = 8A$
- Both above conditions have to be stable for 3 minutes

If the battery is not fully charged or if the automatic synchronisation does not happen, the state of charge value will start to drift and will eventually not represent the actual state of charge of the battery.

The following parameter(s) will have an effect on automatic synchronisation if they have been set incorrectly:

- Charged voltage
- Tail current
- Charged detection time
- Not occasionally fully charging the battery

For more information on these parameters see the chapter: "Battery settings".

Incorrect state of charge due to incorrect current reading:

The state of charge is calculated by looking at how much current flows in and out of the battery. If the current reading is incorrect, the state of charge will also be incorrect. See paragraph [Incomplete current reading \[24\]](#)

11.3.5. State of charge always shows 100%

One reason could be that the negative cables going in and out of the battery monitor have been wired the wrong way around, see [Charge and discharge current are inverted \[24\]](#).

11.3.6. State of charge does not reach 100%

The battery monitor will automatically synchronise and reset the state of charge to 100% as soon as the battery has been fully charged. In case the battery monitor does not reach a 100% state of charge, do the following:

- Fully charge the battery and check if the battery monitor correctly detects if the battery is fully charged.
- If the battery monitor does not detect that the battery has been fully charged you will need to check or adjust the charged voltage, tail current and/or charged time settings. For more information see [Automatic synchronisation](#).

11.3.7. State of charge does not increase fast enough or too fast when charging

This can happen when the battery monitor thinks the battery is bigger or smaller than in reality. Check if the [battery capacity](#) has been set correctly.

11.3.8. State of charge is missing

This means that the battery monitor is in an unsynchronised state. This can occur when the has just been installed or after the has been unpowered for some time and is being powered up again.

To fix this, fully charge the battery. Once the battery is close to a full charge, the battery monitor should synchronise automatically. If that doesn't work, review the synchronisation settings.

11.3.9. Synchronisation issues

If the battery monitor does not synchronise automatically, one possibility could be that the battery never reaches a fully charged state. Fully charge the battery and see if the state of charge eventually indicates 100%.

Another possibility is that the charged voltage setting should be lowered and/or the tail current setting should be increased.

It is also possible that the battery monitor synchronises too early. This can happen in solar systems or in systems that have fluctuating charge currents. If this is the case change the following settings:

- Increase the “charged” voltage to slightly below the absorption charge voltage. For example: 14.2V in case of 14.4V absorption voltage (for a 12V battery).
- Increase the “charged detection time” and/or decrease the tail current to prevent an early reset due to passing clouds.

11.4. GX device issues

This chapter only describes the most common issues. If this chapter does not solve your issue, consult the manual of the GX device.

Incorrect CAN-bus profile selected

Check that VE.Can is set to use the correct CAN-bus profile. Navigate to settings/services/VE.Can port and check if it is set to “VE.Can and Lynx Ion BMS 250kb”.

RJ45 terminator or cable issue

VE.Can devices connect in “daisy chain” to each other and a [RJ45 terminator](#) needs to be used with the first and last device in the chain.

When connecting VE.Can device always use “manufactured” [RJ45 UTP cables](#). Do not manufacture these cables yourself. Many communication and other seemingly unrelated product issues are caused by faulty home made cables.

12. Warranty

This product has a 5-year limited warranty. This limited warranty covers defects in materials and workmanship in this product and lasts for five years from the date of original purchase of this product. To claim warranty the customer must return the product together with the receipt of purchase to the point of purchase. This limited warranty does not cover damage, deterioration or malfunction resulting from alteration, modification, improper or unreasonable use or misuse, neglect, exposure to excess moisture, fire, improper packing, lightning, power surges, or other acts of nature. This limited warranty does not cover damage, deterioration or malfunction resulting from repairs attempted by anyone unauthorized by Victron Energy to make such repairs. Non-compliance with the instructions in this manual will render the warranty void. Victron Energy is not liable for any consequential damages arising from the use of this product. The maximum liability of Victron Energy under this limited warranty shall not exceed the actual purchase price of the product.

13. Technical specifications Lynx Shunt VE.Can

Power	
Supply voltage range	9 - 70 VDC
Supported system voltages	12, 24 or 48V
Reverse polarity protection	No
Current rating	1000A
Power consumption relay inactive	<75mA
Power consumption relay active	<90mA
Potential free alarm contact	3A, 30Vdc, 250Vac

Connections	
Busbar	M8
Fuse	M8
VE.Can	RJ45 and RJ45 terminator
Power supply connection to Lynx Distributor	RJ10 (a RJ10 cable ships with each Lynx Distributor)
Temperature sensor	Screw terminal
Relay	Screw terminal

Physical	
Enclosure material	ABS
Enclosure dimensions (hxwxd)	190 x 180 x 80mm
Unit weight	1.4 kg
Busbar material	Tinned copper
Busbar dimensions (hxw)	8 x 30mm

Environmental	
Operating temperature range	-40°C to +60°
Storage temperature range	-40°C to +60°
Humidity	Max. 95% (non-condensing)
Protection class	IP22

14. Appendix