

V 1.0

AM-5 MANUAL



It is important that you read this manual before attempting the installation of your battery. Please take note of certain steps to ensure correct inverter compatibility.

Please visit www.hubblelithium.co.za or the latest version of this manual.



WARNING:

Working with high voltage systems is dangerous. Do not attempt to modify your inverter and battery setup unless you are certain you understand the risk. Speak to a qualified electrician if you are unsure.

INDEX

PRODUCT DESCRIPTION	1
PRODUCT SPECIFICATIONS	2
PARALLEL CONNECTION OF BATTERIES	3
INSTALLATION NOTES	4
INTERFACE DEFINITION	7
INTERFACE FUNCTIONS	10
PARALLEL FUNCTIONS	11
WARNINGS	12
COMPLETING SETUP	13

PRODUCT DESCRIPTION



SMART

Every module is equipped with an independent BMS system.



EASY INSTALLATION

Just plug & play.



SAFE

Safe lithium iron phosphate battery cell.



CERTIFIED

CE IEC UN38.3 MSDS.



MODULAR

Modular expansion



LONGER LIFETIME

6000 cycles, 15 years design life.

TECHNICAL SPECIFICATIONS

Model	AM-5
Battery Type	LiFePO4 (LFP)
Normal Voltage (V)	51.2V
Normal Energy (KWH)	5.12KWH
Design Capacity	100AH
Design Years	15 Years

PRODUCT SIZE

Size	600*510*173mm
Weight	51kg

TECHNICAL PARAMETERS

Cycle Life	≥6000 80% DOD
Operating Voltage Range	40V-58.4V
Charging Voltage	DC 58.4V
Charge/Discharge Current(A)	Same Port 100A
Internal Resistance	≥30mΩ

BMS PARAMETERS

Self-Consumption	≥2W
Rated Voltage	51.2V
Balance Current	30-65(MA)
Communication Method	CAN/RS485/RS232
Intelligent Current Limiter	20A

AMBIENT TEMPERATURE

Operating Temperature	-10C ~ 50C
Storage Temperature	10 C ~ 50C
Humidity	15% ~ 75%

Lithium battery systems are widely used in residential energy storage systems, such as solar energy storage systems and UPS. The power wall LiFePO4 battery pack adopts the international advanced lithium iron phosphate battery application technology and BMS control technology.

INTERFACE

& SIZE

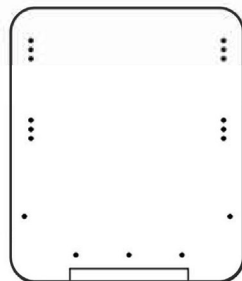
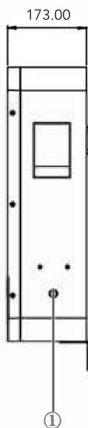
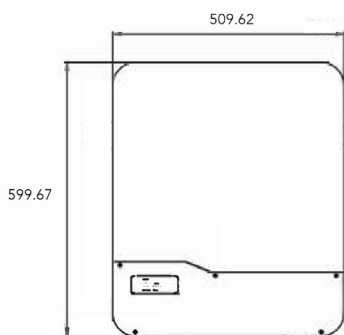

1. POWER SWITCH
2. BATTERY LINK
3. BATTERY LINK
4. RS232
5. CAN/RS485
- EXTERNAL COMMUNICATION
6. DRY CONTACT
7. ADD
8. RST
9. BATTERY +
10. BATTERY -

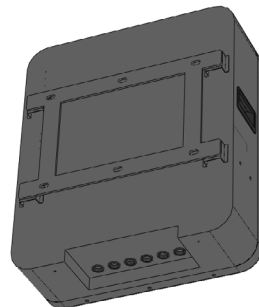
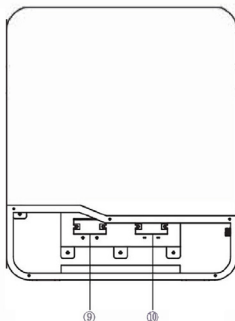
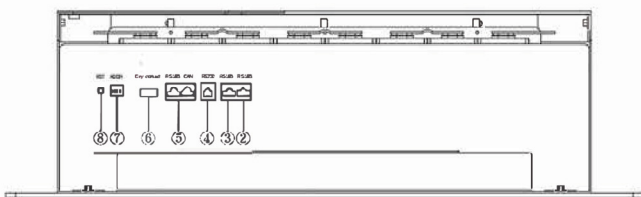

BRACKET PLACEMENT

PARALLEL

CONNECTION OF BATTERIES

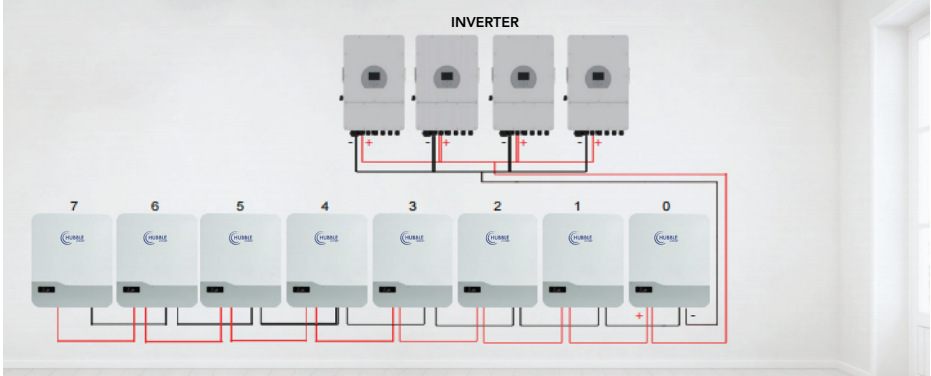

SOLUTION DIAGRAM:

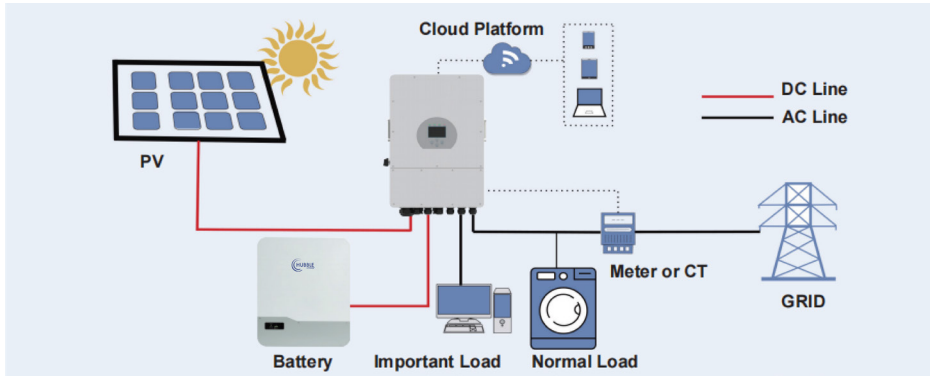

SUN SYNK

Deye 德业

solar edge

GOODWE

Growatt

Sol-Ark

SOLAX POWER

STUDER

bbb
PURSUIT OF PERFECTION

invr

HUAWEI

ENPHASE

MPP Solar
Digging Solar Market in this city

Voltronic Power
SOLAR POWER

SOFAR
SOLAR

SMA

solis
INVERTERS

victron energy

LU X POWER TEK

OutBack
POWER

EPEVER
SOLAR TECHNOLOGY

MUST

SUNGROW
阳光电源

KSTAR

SRNE 日白

Schneider
Electric

Amern

INSTALLATION

NOTES

1. As shown in the figure below, press the mounting structure on the wall surface, use a marker to draw the installation positioning hole of the fixed pendant, remove from wall and drill the holes.

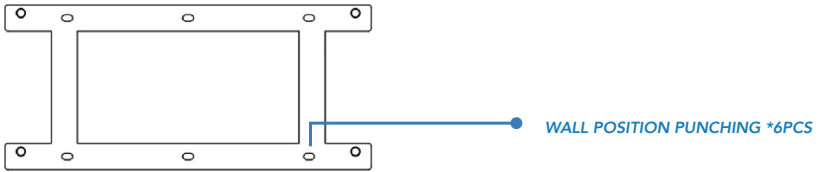

2. As shown in the figure below, fix the attached six expansion bolts in the opening of the mounting structure, and tighten the nuts on the bolts.

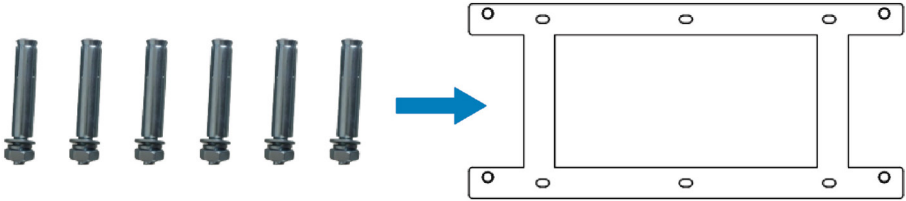

3. Lift up the AM-5 battery carefully and hook it into position securely onto the wall mount bracket.

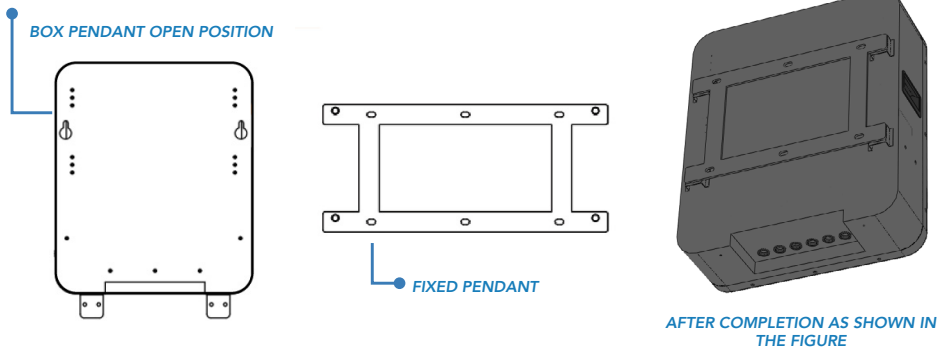

TABLE 1 LED WORKING STATUS INDICATION







STATUS	NORMAL / ALARM / PROTECTION	RUN	ALM	SOC INDICATION LEDES				REMARK
								
POWER OFF	Dormancy	OFF	OFF	OFF	OFF	OFF	OFF	All off
STANDBY	Normal	Fash 1	OFF	According to the electricity instruction				Standby state
	Alarm	Flash 1	Flash 3					Cell low voltage
CHARGE	Normal	Lighting	OFF	According to the electricity instruction (Power level indicates maximum LED flash 2)				Alarm when overvoltage light is off
	Alarm	Lighting	Flash 3					
	Overcharge Protection	Lighting	OFF	Lighting	Lighting	Lighting	Lighting	If there is no charging the LED light is in standby state
	Temperature Over-current Protection	OFF	Lighting	OFF	OFF	OFF	OFF	Stop charging
DISCHARGE	Normal	Flash 3	OFF	According to the electricity instruction.				
	Alarm	Flash 3	Flash 3					
	Undervoltage protection	OFF	OFF	OFF	OFF	OFF	OFF	Stop discharge
	Temperature Overcurrent Short-circuit Reverse connection Failure protection	OFF	Lighting	OFF	OFF	OFF	OFF	Stop discharge
FAIL		OFF	Lighting	OFF	OFF	OFF	OFF	Stop charging and discharging.

TABLE 2 CAPACITY INDICATION INSTRUCTIONS

STATE		CHARGE				DISCHARGE			
Capacity Indicator Light		L4	L3	L2	L1	L4	L3	L2	L1
Battery Power (%)	0 ~ 25%	OFF	OFF	OFF	Flash 2	OFF	OFF	OFF	Lighting
	25 ~ 50%	OFF	OFF	Flash 2	Lighting	OFF	OFF	Lighting	Lighting
	50 ~ 75%	OFF	Flash 2	Lighting	Lighting	OFF	Lighting	Lighting	Lighting
	75 ~ 100%	Flash 2	Lighting	Lighting	Lighting	Lighting	Lighting	Lighting	Lighting

TABLE 3 LED FLASH INSTRUCTIONS

FLASH MODE	ON	OFF
FLASH 1	0.25 S	3.75 S
FLASH 2	0.5 S	0.5 S
FLASH 3	0.5 S	1.5 S

Note: You can enable or prohibit LED indicator light alarm through the upper machine, the factory default is enabled.

TABLE 4 DUAL SWITCH POSITION



ADDRESS	CODES THE SWITCH POSITION			
	#1	#2	#3	#4
1	OFF	OFF	OFF	OFF
2	ON	OFF	OFF	OFF
3	OFF	ON	OFF	OFF
4	ON	ON	OFF	OFF
5	OFF	OFF	ON	OFF
6	ON	OFF	ON	OFF
7	OFF	ON	ON	OFF
8	ON	ON	ON	OFF
9	OFF	OFF	OFF	ON
10	ON	OFF	OFF	ON
11	OFF	ON	OFF	ON
12	ON	ON	OFF	ON
13	OFF	OFF	ON	ON
14	ON	OFF	ON	ON
15	OFF	ON	ON	ON
16	ON	ON	ON	ON

INTERFACE

DEFINITION

DIAGRAM OF THE COMMUNICATION INTERFACE

RS232 communication port definition:

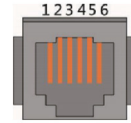

INTERFACE	DEFINED DECLARATION	
RJ12, RS232 pin layout	PIN 1	NC (empty)
	PIN 2	NC (empty)
	PIN 3	TX protection board sends data (computer receiving data foot)
	PIN 4	RX protection board receives data (computer sends data)
	PIN 5	Ground signal ground
	PIN 6	NC (empty)

RS 485-1 / CAN COMMUNICATION INTERFACE DEFINITION:

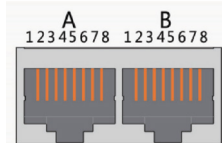

INTERFACE	DEFINED DECLARATION		DEFINED DECLARATION			
X1 Communication port definition	RJ45 CAN pin layout	PIN 1	CANL	RJ45, RS485 pin layout	PIN 1	RS485-B1
		PIN 2	CGND		PIN 2	RS485-A1
		PIN 3	NC (empty)		PIN 3	RS485-GND
		PIN 4	CANH		PIN 4	RS485-B1
		PIN 5	CANL		PIN 5	RS485-A1
		PIN 6	NC (empty)		PIN 6	RS485-GND
		PIN 7	CGND		PIN 7	NC (empty)
		PIN 8	CANH		PIN 8	NC (empty)

RS485-2 COMMUNICATION INTERFACE DEFINITION:

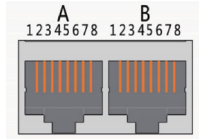

INTERFACE	DEFINED DECLARATION		DEFINED DECLARATION			
Battery link ports	A part RS-485-2 Interface	PIN 1	RS485-B2	B part RS-485-2 Interface	PIN 1	RS485-B2
		PIN 2	RS485-A2		PIN 2	RS485-A2
		PIN 3	RS485-GND		PIN 3	RS485-GND
		PIN 4	NC (empty)		PIN 4	NC (empty)
		PIN 5	NC (empty)		PIN 5	NC (empty)
		PIN 6	RS485-GND		PIN 6	RS485-GND
		PIN 7	RS485-A2		PIN 7	RS485-A2
		PIN 8	RS485-B2		PIN 8	RS485-B2

DRY CONTACT DESCRIPTION

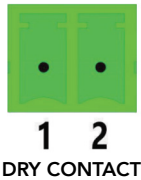

This BMS can provide one channel of dry contact signal, all dry contact signals are passive switches, regardless of polarity.

KRY 1 (2P terminal)		
BMS STATE	DESCRIPTION	REMARK
Normal Operation	1/2 pin is disconnected	
BMS Alarm	1/2 pin is connected	Output when SOC alarm, under voltage and over voltage alarm and BMS protection state, such as under voltage protection, over voltage protection or short circuit protection;

BUTTON OPERATION INSTRUCTIONS

- When the BMS is in sleep state, press the button for more than 1 S, the protection board is activated.
- When the BMS is in operating state, press the button more than 3 seconds and less than 6 seconds, then the BMS will enter sleep state. When the BMS is in working state, the protection board will reset when the button is pressed for more than 6S.

BUZZER ACTION DESCRIPTION

- In the case of short-circuit protection, the buzzer beeps every 2 seconds. If a short circuit is detected 3 times in a row then the short-circuit protection is locked and the buzzer will no longer beep. Disconnect the battery and wait a few minutes to switch it back on. It might take up to 5 minutes to re-detect a clear condition and then the BMS will re-enable.

INTERFACE

FUNCTIONS

WARNING

Interfacing or plugging in any 3rd party or non approved Hubble products or peripherals into the RS232 (serial) or RS485 (Battery Link) ports, can cause damage to the BMS and cause the BMS to malfunction. This may also result in damaging the internal cells. Plugging in non approved Hubble products into these ports can immediately void your warranty.

DESCRIPTION OF SLEEP FUNCTION

In order to reduce the power consumption of the whole system, the system has a sleep function.

When the following conditions are met, the system will enter the sleep mode:

1. The over-discharge protection of the BMS has not been released for 5 minutes.
2. The duration of the standby state has reached 24 hours (no communication, no charge and discharge, no charger connected).

DESCRIPTION OF WAKE-UP FUNCTION

Please note that the battery enters sleep mode due to single or overall over-discharge, and cannot be activated or switched on by serial port or the comm ports.

The BMS will activate and wake from sleep when the following is detected:

1. If a charge current is applied to the battery from the inverter/ups.
2. If the power button is pressed.
3. Through communication from the RS232 or CANBus in certain circumstances.

CURRENT LIMITING FUNCTION

The BMS has an advanced current limiting function built in. The charge current limiter is designed to activate if the charging current has reached the maximum battery design charge limit. This ensures the battery does not disconnect from the circuit and the current limiter takes over and reduces the charge to 20Amps per battery.

The default start-up condition of the charging current limit is to start when the charging current is greater than 100A. After entering the current limit, the test will be performed again every 10 minutes. When the current is less than the current limit start value, the current limit function will be turned off. When the current is bigger than the current limit start value, then the current limiting mode with stay enabled.

COMMUNICATION DESCRIPTION

1. The RS232 port is only for use with Hubble specific peripherals or technicians or at a service centre to interface with the BMS. Attempting to use this port for anything else or 3rd party products can cause damage.
2. The CAN Port is specifically to be used to any interfacing 3rd party equipment like inverters etc. This port is dedicated to inverters and other CAN bus ports for communication to get battery information.
3. The RS485 communication port can be interfaced with 3rd party inverters that do not have a CAN port and is supported by Hubble.
4. The Battery link ports are only for connecting more batteries of the same model to increase capacity and to enable multiple battery communications.

OPTIONAL CLOUDLINK DEVICE

The Hubble Cloudlink is an optional add-on to the Hubble X and AM range of products. As long as the device is connected to Wi-Fi it will cloud all battery and inverter data to our cloud-server, enabling users to remotely monitor their power system.

Learn more about the Hubble Cloudlink here:

<https://www.hubblelithium.co.za/cloudlink>

Access the latest Cloudlink Setup Guide here:

<https://www.hubblelithium.co.za/cloudlink>



PARALLEL FUNCTIONS

PARALLEL (CASCADE) FUNCTION OF BATTERY PACKS

When the battery packs are cascaded, the one with the communication address of 0001 is called the master battery pack, and the other ones with the communication address are called the slave battery packs. The slave battery packs can communicate with the master battery pack through the RS485 communication interface, and the master battery pack centrally packs and manages the data of each battery pack in this cascaded system.

When the battery packs are cascaded, only the main battery pack can communicate with the host computer, upload the data, status and information of all battery packs in the cascaded system, integrate monitoring and management, and realize remote monitoring.

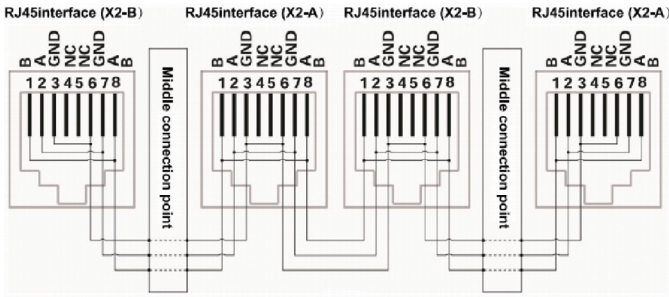

RS485 PARALLEL WIRING DIAGRAM

When performing multi-machine parallel communication operation, it is necessary to configure the DIP address of each PACK first. The dialing code adopts BCD code format, the definition is:



(black is OFF, blank is ON)

WARNING

TO ENSURE PROPER USE OF THE BATTERY PLEASE READ THE MANUAL CAREFULLY BEFORE USING IT.

HANDLING

Do not expose the battery to fire.
Do not place the battery on charge with wrong terminals connected.
Avoid short circuiting the battery .
Avoid excessive physical shock or vibration.
Do not disassemble or deform the battery.
Do not immerse in water.
Do not mix the battery with other different makes, types, or model batteries.
Keep out of the reach of children.

CHARGE AND DISCHARGE

The battery must be charged with an appropriate charger/inverter only.
Never use a modified or damaged charger.

STORAGE

Store the battery in a cool, dry and well-ventilated area.

DISPOSAL

Regulations vary for different countries. Dispose of in accordance with local regulations.

BATTERY OPERATION INSTRUCTIONS

CHARGING

Charging current: Do not surpass the specified charging current.
Charging voltage: Do not surpass the specified charging voltage.
Ensure correct DC polarity before connecting the terminals.

DISCHARGING CURRENT

The discharging current must not surpass this maximum battery specification.

BATTERY STORAGE

The battery should be stored in the temperature range stipulated in the specification book. If it surpasses above this temperature range for six months in long time storage, it is suggested that you should carry on additional charge to the battery.

COMPLETING

SETUP

CONGRATULATIONS!

Once all the above steps have been completed you can proceed to follow the start-up instructions given by your inverter manufacturer.

If you have any difficulties with setting up your system, please contact our Technical Support Department via support@hubblelithium.co.za. Be sure to include the following information in your initial email so that we can provide you with timely assistance:

1. Inverter make & model
2. Model & number of connected batteries
3. Are your batteries in Series or Parallel?
4. A brief description of your system and any issues you may be having
5. If possible; images of your power system
6. Contact Details, if we should need to contact you



**VIEW OUR WEBSITE
FOR MORE
INFORMATION**

www.hubblelithium.co.za