

ELECTRIC FIREPLACE INSERT

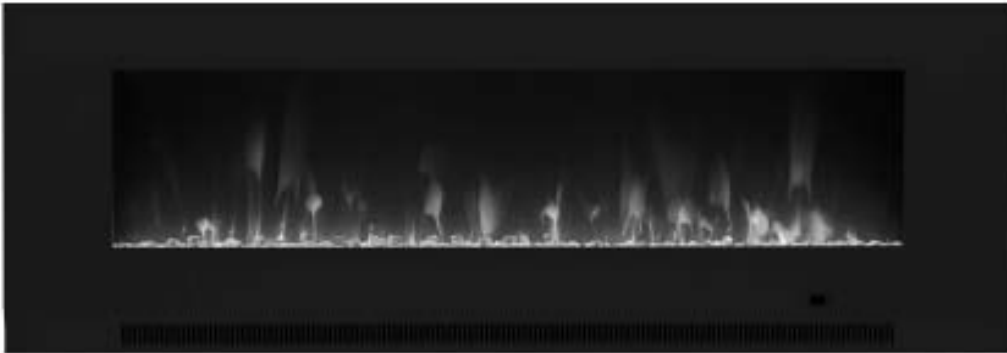

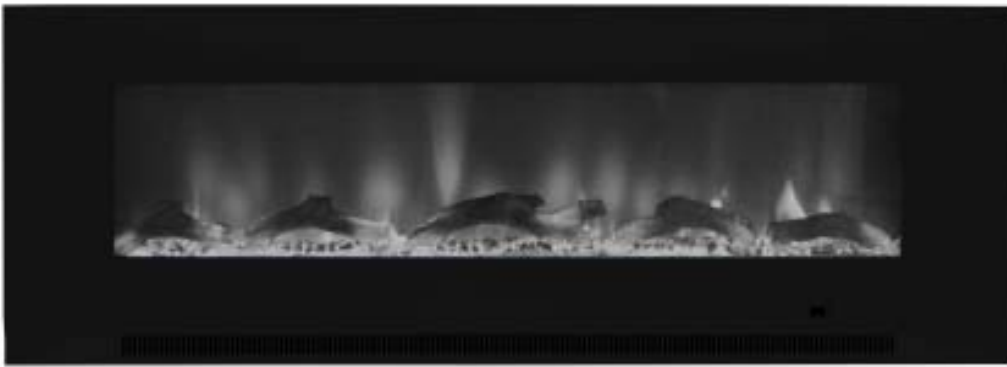

NO VENTING REQUIRED
PRODUCES SAFE EFFICIENT HEAT
PLEASE READ THIS ENTIRE INSTRUCTIONS MANUAL BEFORE USING
220-240VOLT 1300WATT
SAVE THESE INSTRUCTIONS FOR FUTURE USE

CONTENTS

	Page
PARTS SUPPLIED	3
SAFETY INFORMATION	3~5
ELECTRICAL SAFETY	6
BEFORE USE!	7
INSTALLATION INSTRUCTIONS	8
REMOVAL OF THE WALL BRACKET	8
ATTACHING THE BRACKET TO THE WALL	9
MOUNTING USING THE INSET BRACKETS	10
HOW TO CHANGE BETWEEN LOGS AND CRYSTALS	11
OPERATION	12~14
REMOTE CONTROL	14
CARE AND MAINTENANCE	15
TROUBLESHOOTING	15
SERVICING	15
TECHNICAL SPECIFICATION	16
WASTE ELECTRICAL RECYCLING	16

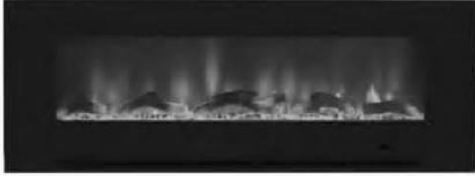
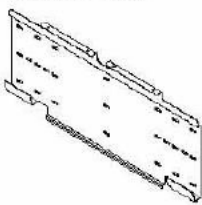
PARTS SUPPLIED

<p>(1) Fireplace assembly 1 PC</p> 	<p>(2) Steel holder 1 PC</p> <p>Supplied mounted to the rear of the fire</p> 
<p>(3) Remote Control 1 PC</p> 	<p>(4) Screw 8 PCS</p>  <p>∅ 4mm x 40mm</p>

SAFETY INFORMATION

When using electrical appliances, basic safety precautions should always be followed, including the following:

- **IMPORTANT:** Read all instructions and warnings carefully before starting installation. Failure to follow these instructions may result in a possible electric shock or fire hazard and will void the warranty
- Before connecting the appliance, be sure that the mains voltage available matches that specified on the rating plate, and that the outlet is suitably grounded.
- This appliance can be used by children aged from 8 years and above and persons with reduced physical, sensory or mental capabilities or lack of experience and knowledge if they have been given supervision or instruction concerning use of the appliance in a safe way and understand the hazards involved.
- Children aged from 3 years and less than 8 years shall only switch on/off the appliance provided that it has been placed or installed in its intended normal operating position and they have been given supervision or instruction concerning use of the appliance in a safe way and understand the hazards involved. Children aged from 3 years and less than 8 years shall not plug in, regulate, or clean the appliance or perform user maintenance
- Children under 3 years should be kept away unless continuously supervised.
- Some parts of this product can become very hot and cause burns. Particular attention has to be given where children and vulnerable people are present.

- If the supply cord is damaged, it must be replaced by the manufacturer, its service agent or a similarly qualified person in order to avoid a hazard.
- **WARNING:** In order to avoid overheating, do not cover the heater.
- The heater must not be located immediately below a socket outlet.
- **CAUTION:** In order to avoid a hazard due to the inadvertent resetting of the thermal cut-out, this appliance must not be supplied through an external switching device, such as a timer, or connected to a circuit that is regularly switched on and off by the utility.
- Do not attempt to repair, disassemble or modify the appliance. This unit contains no user-serviceable parts.
- Always unplug or disconnect the appliance from the mains power supply when not in use, or when moving or cleaning it. Do not pull the cord to unplug the heater.
- Keep the heater clean. Do not allow any object to enter the ventilation or exhaust opening as this may cause electric shock, fire, or damage to the heater.
- Do not use the appliance for other than its intended use. It is designed for domestic indoor use only.
- There may be a trace of odour during the first few minutes of initial use, or after a period of storage. This is normal and will quickly disappear.
- If the glass is damaged, do not use the heater in order to avoid a hazard.
- Avoid the use of an extension cord, as the cord may overheat and cause a risk of fire.
- This fireplace is hot when in use. To avoid burns, do not let bare skin touch hot surfaced. If provided, use handles when moving this appliance.
- Keep combustible materials, such as furniture, pillows, bedding, papers, clothes and curtains at least 3 feet from the front and sides of this appliance.
- This appliance is designed for indoor use only and is not intended for use in bathrooms, laundry areas and similar indoor locations. Never locate this appliance where it may fall into a bathtub or otherwise become exposed to water.
- Do not run the cord under carpeting. So not cover the cord with throw rugs, runners or the like. Ensure the cord is kept away from traffic areas, and kept in a position which would not present a trip hazard.
- To disconnect this appliance, turn the controls to the off position, then remove the plug from the outlet.
- This appliance has hot and arching or sparking parts inside. Do not use it in areas where gasoline, paint, or any flammable liquids are used or stored.
- This appliance should not be used as a drying rack for clothing, nor should Christmas stockings or decorations be hung on or near it.
- This electric fire is an instant heat source to warm up a room and is great for visual room ambiance it doesn't necessary need to be used as a constant or permanent source of heating for the home.

- Clean the fire regularly to prevent the build-up of hairs dust or lint around the fire, as this may cause the outlet to become blocked.
- Do not use aerosols or steam cleaners on or around the fire.

Manual Handling

- The heater must not be moved while in use. Please allow a suitable amount of time for the unit to cool before attempting to move it.
- One person should be sufficient to lift the heater. If for any reason it is considered too heavy then obtain assistance.
- When lifting always keep your back straight. Bend your legs and not your back.
- Avoid twisting at the waist. It is better to reposition your feet.
- Avoid upper body / top heavy bending. Always bend from the knees rather than the waist. Do not lean forward or sideways whilst handling the heater.
- Always grip with the palm of the hand. Do not use the tips of fingers for support.
- Always keep the heater as close to the body as possible. This will minimize the cantilever action.
- If required, use gloves to provide additional grip.
- Always use assistance if required.

ELECTRICAL SAFETY

The heater must not be located under an electrical socket; the socket must always be accessible in order to disconnect the heater from the electrical supply for maintenance and cleaning.

Important! This heater must be earthed. The mains supply must be safely routed from the heater to an electrical socket.

If the supply cord is damaged, it must be replaced by the manufacturer, service agent or a similarly qualified person in order to avoid a hazard.

This appliance is supplied with a BS1363 3 pin plug fitted with a 13 Amp fuse. Should the fuse require replacement, it must be replaced with a fuse rated at **13 Amp** and approved to BS1362.

In the event the mains plug has to be removed or replaced for any reason, please note:

The wires in the mains lead on this appliance are coloured in accordance with the following code:

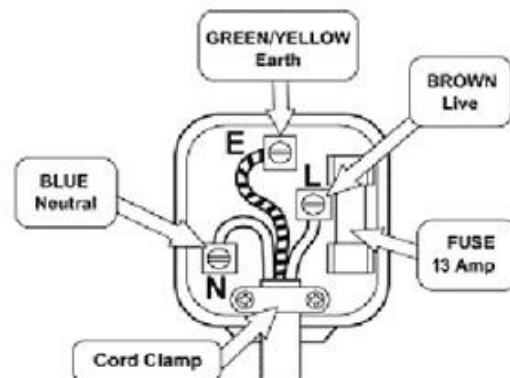

Green and Yellow - Earth

Blue - Neutral

Brown - Live

As the colours may not correspond with the markings identifying the terminals in your plug, please proceed as follows.

- The green and yellow wire must be connected to the terminal in the plug which is marked with the letter E or with the earth symbol \perp or coloured green and yellow.
- The blue wire must be connected to the terminal marked N or coloured black.
- The brown wire must be connected to the terminal marked L or coloured red.

Important - any cut off plug should be disposed of safely to prevent a hazard. There is a danger of electric shock if a cut off plug is inserted into a socket outlet.

BEFORE USE!

Ensure that any packaging material is removed from within the fire box, before its first use.



To do this the front glass panel must be removed from the fire.

Remove the centre screw out of each side bracket as per images 1 and 2.

Then the three screws fixing the glass should be removed as shown image 3, which will then allow the front glass panel to be lifted and removed from the front of the fire (Image 4).

The packaging within the fire box can then be accessed.

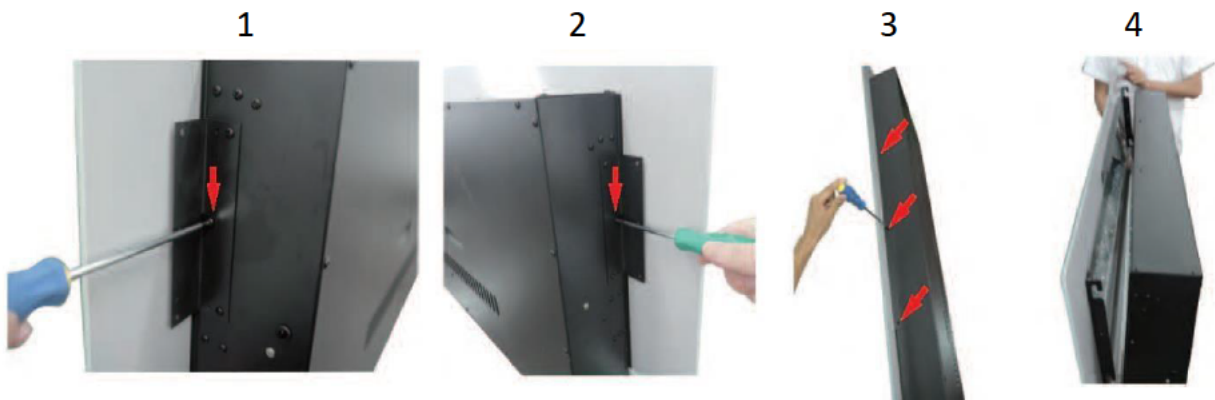

Refitting the glass fascia can be done, by following the reverse of the steps above.

INSTALLATION INSTRUCTIONS

REMOVAL OF THE WALL BRACKET

Remove the four screws circled in the diagram below using a screwdriver. While applying upwards pressure as shown by arrow 1, slowly ease the top of the bracket away from the fire, as shown by arrow 2.

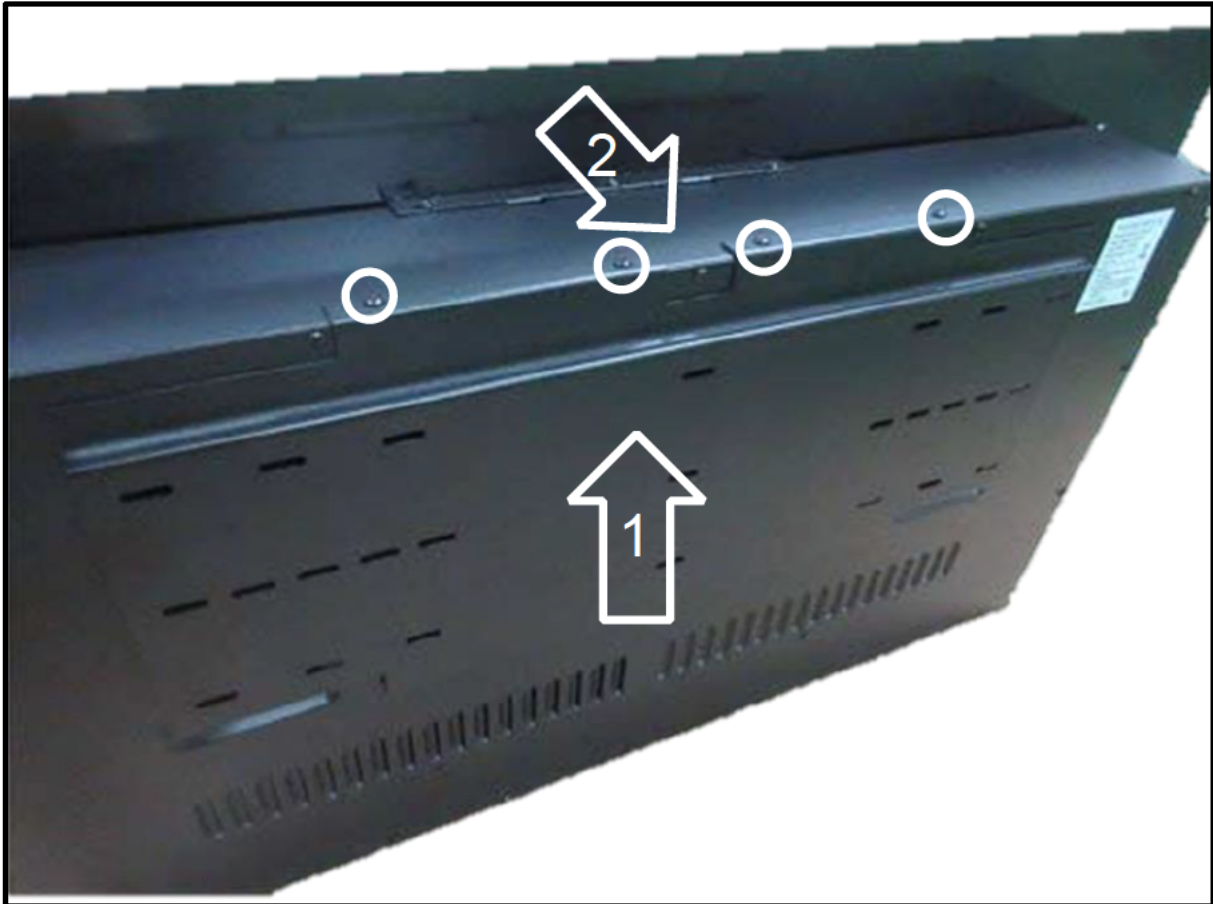

TIP :

If you are struggling to remove the bracket, undo the three screws circled to the right, which will then allow the bracket to be removed more easily. Please ensure these screws are replaced before installing the fire.



ATTACHING THE BRACKET TO THE WALL

The fire is attached to the wall using the supplied wall bracket. Before attaching the bracket to the wall, ensure you are aware of the position of the studs behind the wall, as for strength it is advisable to screw directly into those (Ensuring that any pipework or wiring is also avoided). We would advise on the use of a spirit level to ensure the bracket is horizontal.

If the wall is of a different construction, suitable fixings should be sourced from a reputable DIY store. In this case, the bracket should be held to the wall, and a spirit level used to ensure it is horizontal, before marking the position with a pencil. The holes should then be drilled, and suitable plugs inserted.

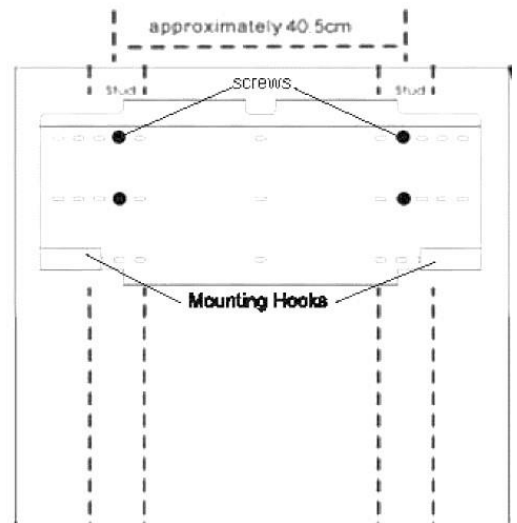

Once the bracket is securely fixed to the wall, the fireplace can then be hooked onto the bracket. Apply a small amount of pressure onto the top of the fire, while slotting the top of the bracket into position, before screwing the bracket back onto the top of the fire with the 4 screws previously removed.

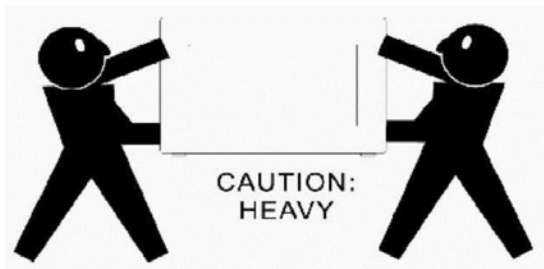

PLEASE NOTE: Due to the size and weight of the fire, we would advise on 2 people carrying this out to prevent injury or damage.

MOUNTING USING THE INSET BRACKETS

Your new fire is also provided with two brackets allowing it to be mounted within a cut out in the wall. To do this remove the centre screw out of each side bracket as per images 1 and 2. Then the three screws fixing the glass should be removed as shown image 3, which will then allow the front glass panel to be lifted and removed from the front of the fire (Image 4).

The fire can then be put into position (Image 5) and mounted with screws (Image 6) through the trim piece. Please ensure the screws / wall plugs used are suitable for the application, and if you are unsure advice should be taken from a suitably experienced tradesperson.

Once the fire is mounted in position the glass can be reattached (Images 7 & 8), and fastened with the screws previously removed (Image 9).

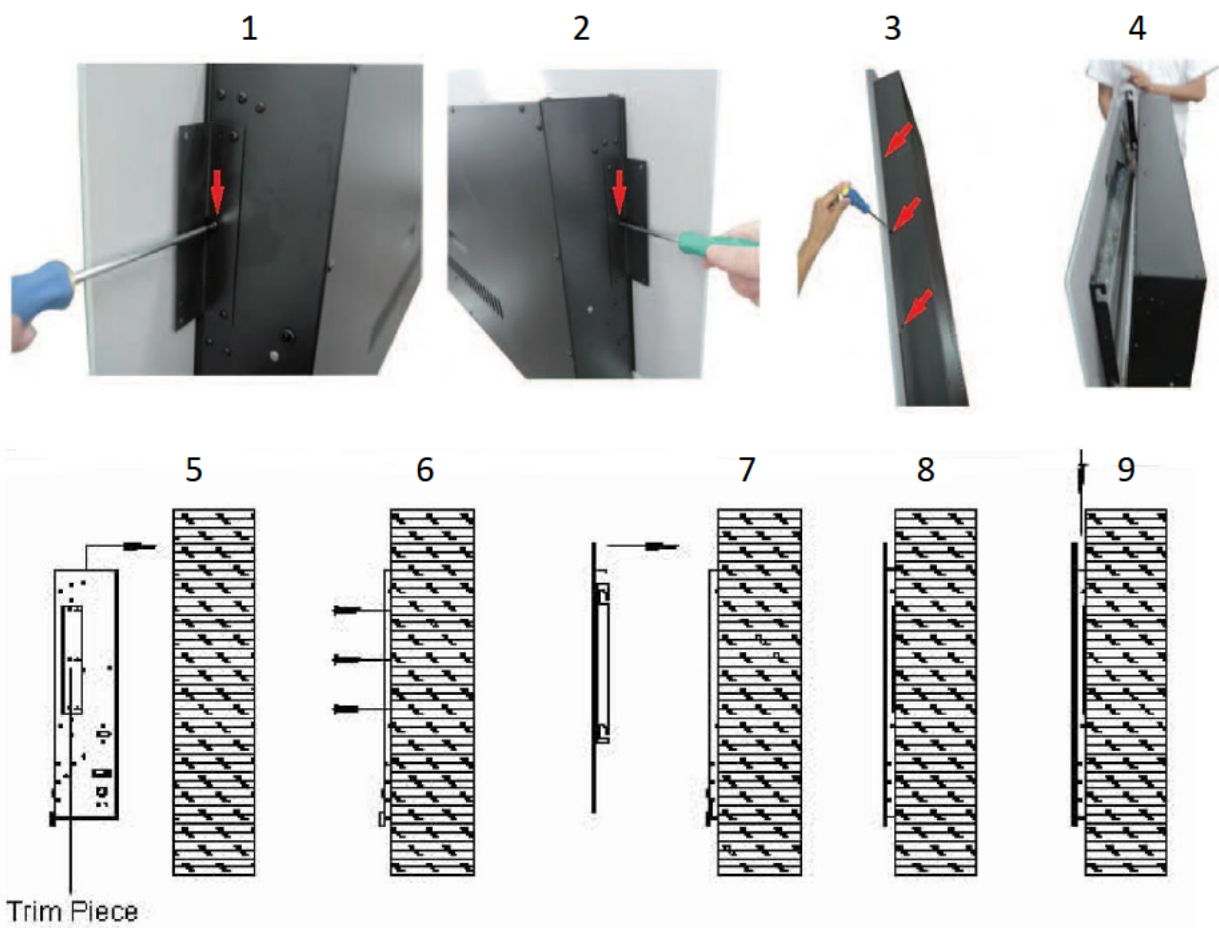

HOW TO CHANGE BETWEEN LOGS AND CRYSTALS

1. Remove the screws which hold the glass in position.



2. Slide the glass front up, and lift it away from the Fire, as shown in the image to the right.



3. Unscrew the two screws holding the logs in position, and lift the log assembly out of the fire, as shown in the images below. Please note the screws should be kept safe in case the logs require refitting in the future.



4. Spread the crystals evenly across the base of the fire.



5. The glass can then be slotted back into position, and fixed using the screws removed in step 1.

OPERATION

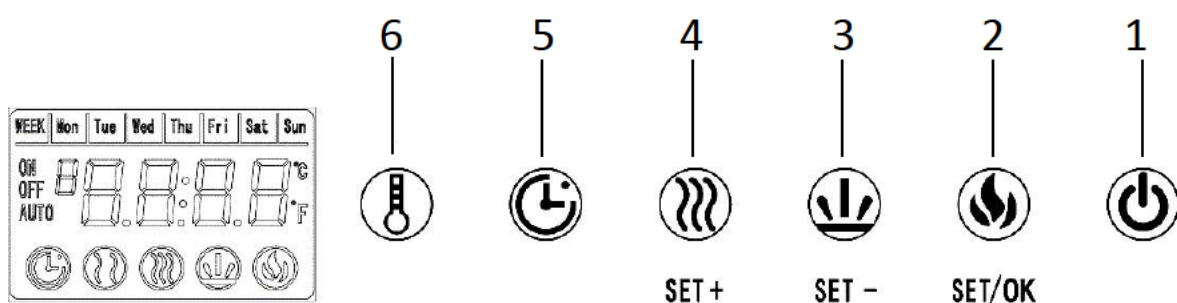

The master power switch is located on the right side of the appliance, and the control panel is on the right corner of the glass.

Master Switch – Main Power switch to turn the unit on and off

1 Standby Button : When pressed the unit will turn on with the same settings as when it was put into standby

2 Flame Adjustment : Can be repeatedly pressed to cycle through the different flame colours, The display will show the code to indicate the colour selected

F1	Orange	F6	Blue and Orange
F2	Orange and Green	F7	Blue, Orange and Green
F3	Green	F8	Blue and Red
F4	Green and Blue	F9	Red
F5	Blue	F0	Loop through all colours



Open Window Detection Function: Your electric fire will monitor the temperature of the room once it has reached the desired temperature. If the room temperature drops by 5°C or more within 10 minutes the unit will assume a window is open and stop the heating function to conserve energy. This feature can be turned on and off by holding the  button.

E0: Open Window Detection function off.

E1: Open Window Detection function on.



3 Charcoal Fire Colour : Can be repeatedly pressed to cycle through the different colours for the charcoal lighting, The display will show the code to indicate the colour selected

C1	Red	C6	White
C2	Blue	C7	Purple
C3	Green	C8	Yellow
C4	Rose Red	C9	Light Blue
C5	Orange	C0	Loop through all colours

4 Heat Settings : Can be pressed to cycle through the different heat settings. First press would activate the low power level of 700W ( displayed) The second press would change it onto the high power level of 1300W ( displayed) and pressing it again would turn the heating off.

Set Current Time and Day: Long press the Heat button  to enter the day / time setting mode. Use the Set + and Set – buttons to select the day, and press OK to confirm. Then use the same buttons to set the number of hours, press OK before setting the minutes value. Press OK to start the clock.

5 Timer : Your fire includes a 7 day timer, which allows you to set two periods of operation per day. The fire will operate with the previously used settings for the heating level, desired temperature, flame and charcoal colour.

Press the Timer button  to turn the timer on and off. The timer symbol  will display to indicate the timer is on.

To set the timer hold the Timer button  for a few seconds until the unit beeps. The unit will display the day, period, and if you are setting the On or Off time. For each Period both the On and Off times must be set.

For each Period:



1. Set the On hour value using the Set + and Set – buttons, press OK to confirm
2. Set the On minute value using the Set + and Set – buttons, press OK to confirm
3. Set the Off hour value using the Set + and Set – buttons, press OK to confirm
4. Set the Off minute value using the Set + and Set – buttons, press OK to confirm

The fire will then move onto the next period / first period of following day, allowing this to be programmed in the same way. The days and periods can be scrolled through by repeatedly pressing OK.

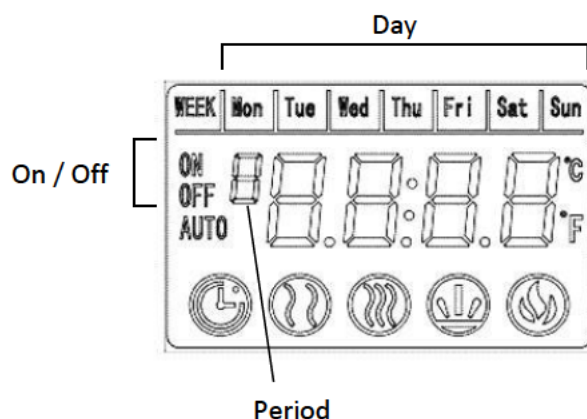
To clear an operational period set the ON and OFF times to the same value.



6 Temperature : The fire is thermostatically controlled and the desired temperature of the room can be set using this button. Repeatedly press the button to set the desired room temperature between 17 and 30 degrees C. The unit will heat the room up to the temperature set, before the heating function stops. If the temperature then drops below the set temperature, the unit will resume heating.

PLEASE NOTE: The Heat setting must also be set to  or  for the unit to output heat.

Change between Celsius and Fahrenheit: Long press the Temperature button  to enter the unit selection. Then use the Temperature button to change the unit between Celsius and Fahrenheit.

REMOTE CONTROL

The buttons on the remote match the functions covered in the previous section unless otherwise stated.

1. Charcoal Fire colour
2. Flame adjustment
3. Charcoal lock to currently displayed colour displayed when in C0 Mode (Loop)
4. Flame lock to currently displayed colour displayed when in F0 Mode (Loop)
5. Change the desired Temperature.
6. Change heat setting between low, high and off
7. Set Current Time and Day.
 - Press once to adjust day using arrow buttons,
 - Press again to adjust hour value,
 - Press again to adjust the minute values
 - Press to start the clock
8. 7 Day Timer
9. Up
10. Down
11. Fahrenheit and Celsius switching
 - Switch between showing the temperature in °C or °F
12. Standby

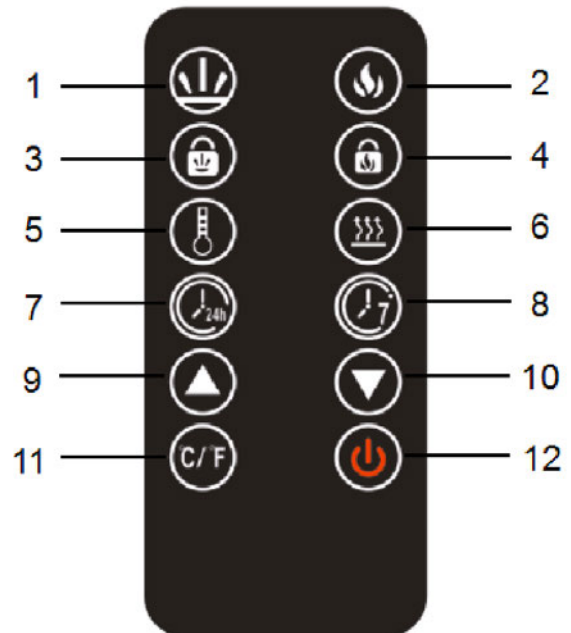

CARE AND MAINTENANCE

When cleaning unit, the power supply should be disconnected and the unit should be cool.

Dust can be removed by lightly wiping the glass surface with clean, lint free cloth or paper towel. To remove fingerprints or other marks, use a damp cloth with a good quality household glass cleaner. The front glass panel should be completely dried before reusing the heater.



CAUTION:

- Do not use abrasive cleaner on glass panel.
- Do not spray liquids directly onto any surface of the unit.
- Do not clean the glass on the inside of the unit as this may cause damage to the surface

TROUBLESHOOTING

Most problems are simple to resolve - please refer to the following table before calling a service engineer:

Problem	Possible Cause	Check
Fire has stopped working	The fire has overheated and the thermal safety device has activated or a circuit breaker has tripped.	Check there is power to the socket where the fire is connected, check the fuse in the plug, and leave for 10 minutes in case of thermal cut-out.
Flame is not moving	Flame motor defective	Contact the retailer or manufacturer.

SERVICING

It is hazardous for anyone, other than a qualified service technician, to carry out any service or repair operation, which involves removal of any components.

TECHNICAL SPECIFICATION

Description of Product	Electric Wall Hanging Fire
Model	BLT-999W-13
Rated Voltage	220-240V ~
Rated Frequency	50/60 Hz
Rated Power	Max 1300W

WASTE ELECTRICAL RECYCLING

This symbol indicates that this product is classed as Electrical or Electronic Equipment and should not be disposed of with other household waste.



The Waste Electrical and Electronic Equipment (WEEE) Directive has been introduced across the European Union:

- To recycle waste electrical products using the best available recovery and recycling techniques in order to minimize the impact on the environment
- To treat any hazardous substances and
- To avoid increasing landfill.

WEEE product should be disposed of by handing it over at a designated collection point.

For more information about where you can drop off your waste product for recycling, please contact your local authority.