

# Rouli Pouf

---

Assembly manual

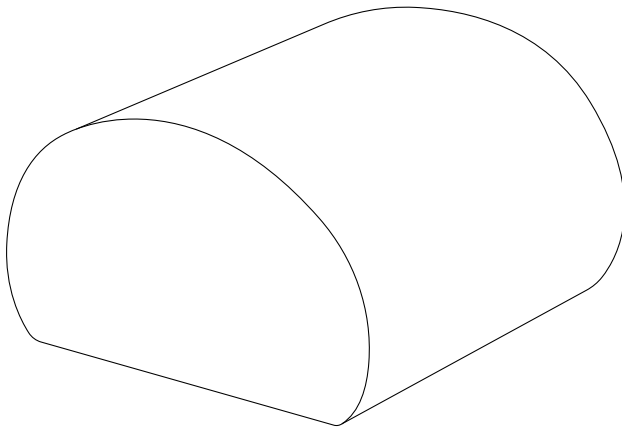

**ferm**  
L I V I N G

# General Instructions

## PLEASE READ BEFORE INSTALLATION

### **WARNING:**

The safety of this fitting can only be guaranteed if the following instructions are observed during both installation and use. Please retain these instructions safely after installation.

### **CARE INSTRUCTION:**

- Cover: 30°C gentle wash. Inside: Professional dry cleaning only.

### **MORE INFORMATION:**

To access further information such as product overview and material descriptions, please visit our website at [www.fermliving.com](http://www.fermliving.com). If you have any questions or comments, please do not hesitate to contact us at [info@fermliving.com](mailto:info@fermliving.com).

# Box Content

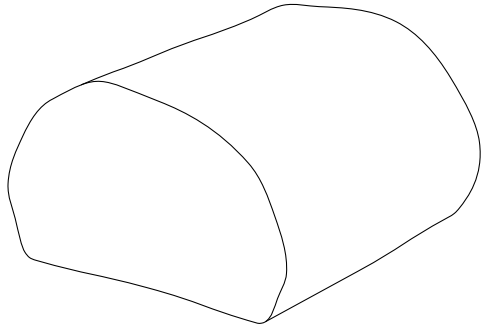

1 x Pouf Cover

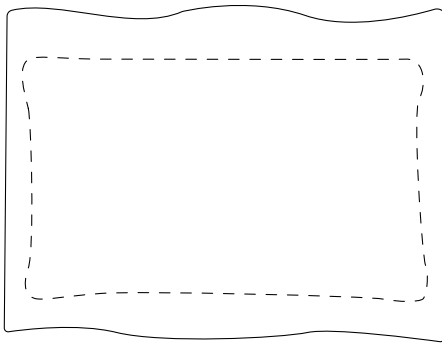

1 x Pouf Foam

# Assembly Process

1

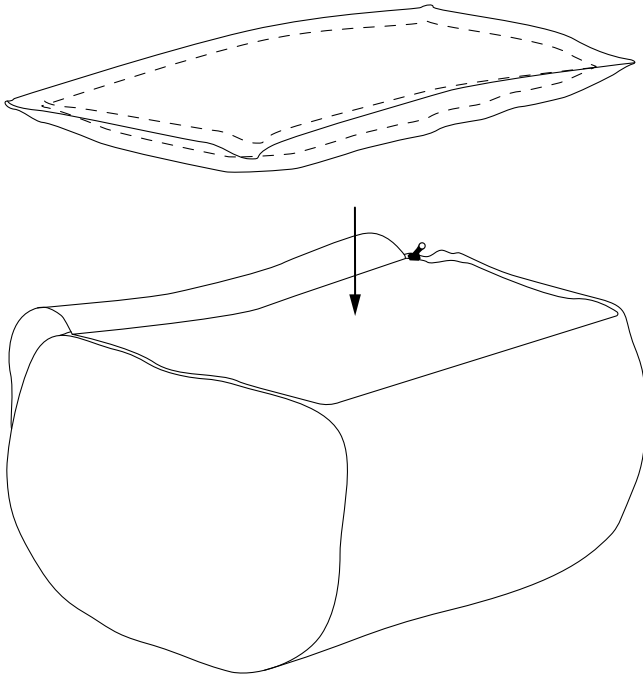

Take the vacuum-packed foam out of the black fabric bag and put it into the cover.

# Assembly Process

2

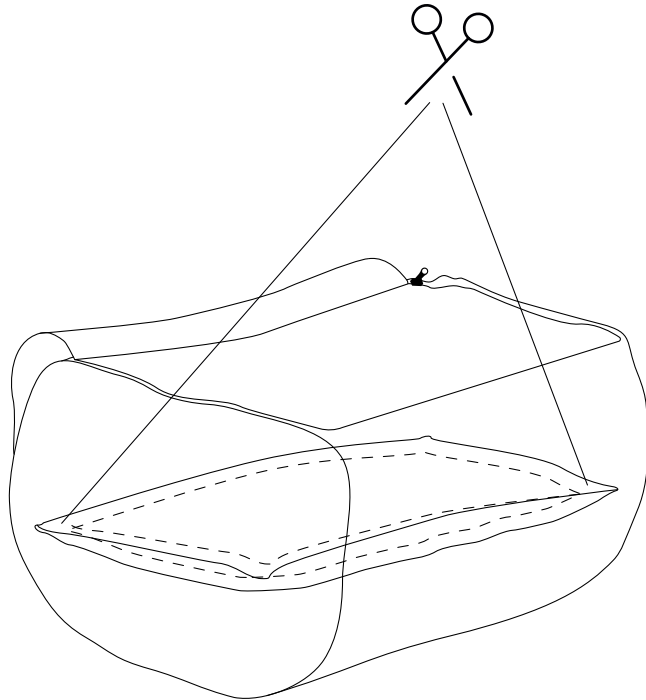

Carefully cut the short sides so the foam can slowly expand.

# Assembly Process

3

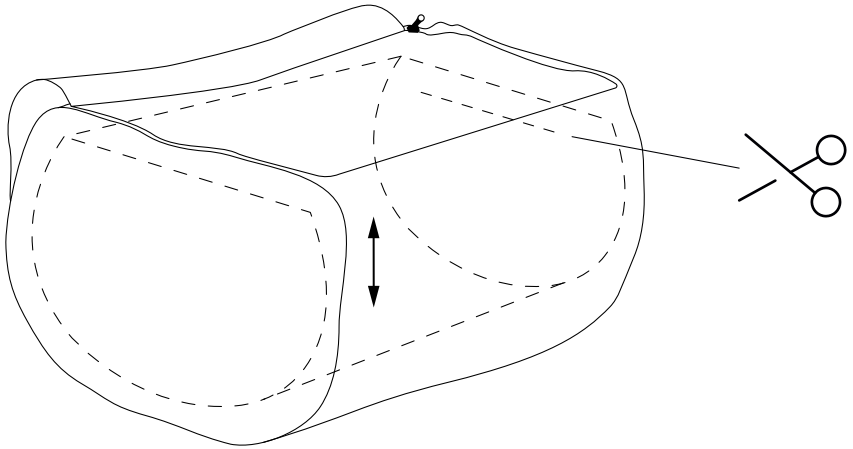

Carefully cut one long side.  
Push the plastic bag at the same long side under the foam.  
Pull the plastic bag out of the cover at the opposite side.

# Assembly Process

4

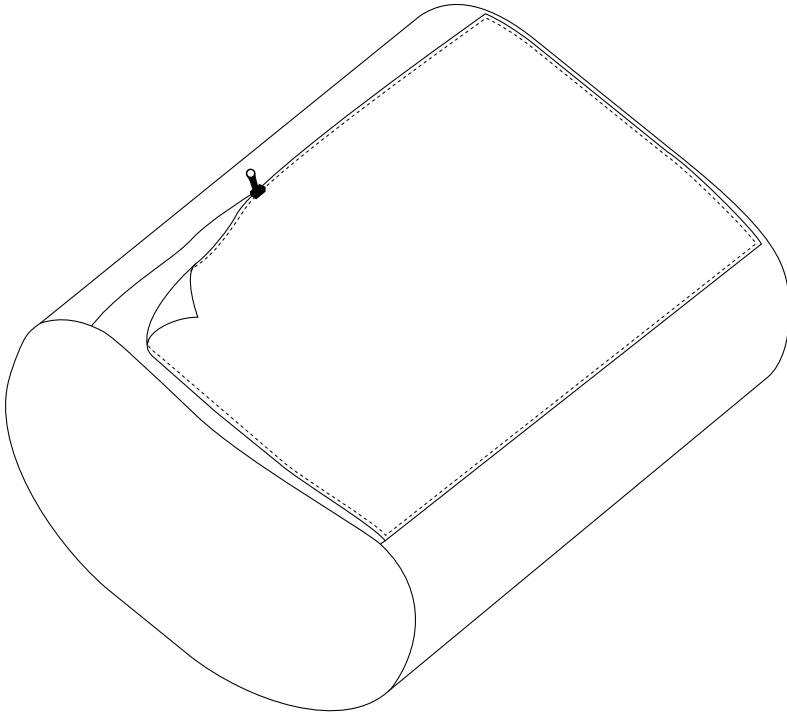

Turn the pouf around and gently close the zipper, section by section.  
If it becomes stuck, do not use excessive force. Wait 24 hours before usage.

[fermliving.com](http://fermliving.com)