

US Phase Pendant Small Installation Instructions

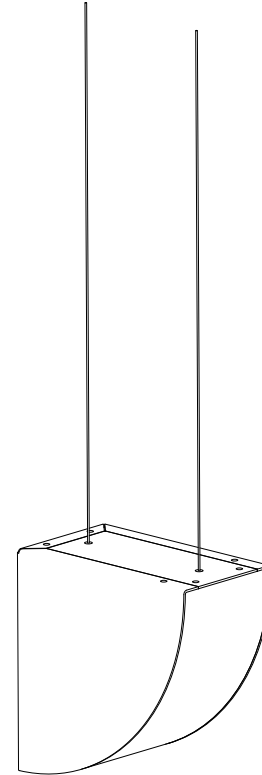

Resident

Phase Pendant Small Installation Instructions

Product Code: PHA01



Warning, installation must be completed by a certified Electrician only.

Assembly Kit Contents:

- 1 x Wago connector 2 pole
- 1 x 24V Driver
- 2 x Suspension Nuts
- 2 x Lock Nuts
- 2 x Nylon Grub Screws
- 1 x Ceiling Bracket
- 1 x Ceiling Bracket Cover
- 6 x Wood Screws
- 1 x Tool

This pendant is an LED luminaire, which requires an external driver to provide a 24V electricity source. The driver included in your purchase is Triac (Phasecut) dimmable. Other types of dimmable drivers are available for individual sale.

1 The Pendant can hang a maximum distance of 2 meters from the ceiling. If this light is being installed in the USA the driver will need be to be placed in a UL registered enclosure. To install the light follow the instructions below:

- Create a cavity in the ceiling to accommodate the driver. Ensure the cavity does not exceed the dimensions of 80mm (3.1 inches) by 45mm (1.8 inches). This cavity should be aligned centrally with the ceiling bracket.
- If installing in the USA, cable entry should be in front of the UL registered enclosure. If required, this will need to be supplied by the installer.

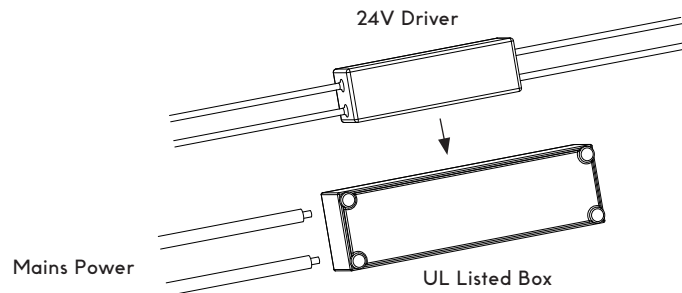

- 6** Step back to check if the pendant is hanging correctly. Adjust cable lengths as needed by loosening the grub screws.
- If the light is hanging at an angle the suspension nut can be adjusted side ways by loosening it with the wrench side of the tool. Ensure all fixings are tightened before proceeding.

For sloped ceilings, the pendant can hang at angles up to 30 degrees.

- Once the pendant is suspended loosen the suspension slot screws. Slide the suspension slot along the bracket until the cables are vertically parallel. Tighten all fixings before moving on.

Loosen the suspension nut using the tool to move the suspension nut side to side.

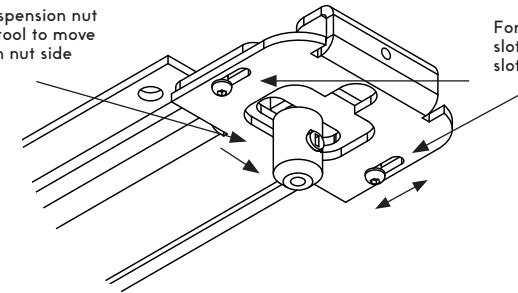

For sloped ceilings loosen the side slot screws to adjust the suspension slot linearly along the bracket.

- 7** Connect the green Earth cable from the ceiling bracket to the Mains Earthing cable using the Wago connector with 2 poles.
- 8** Secure the ceiling bracket cover onto the ceiling bracket by aligning the side holes and using the two bracket screws provided.

Your pendant is now installed.

2 Connect the Driver to mains power:

- Connect the line of incoming mains Live to power supply via the L pin on the input side of the driver.
- Connect the line of incoming mains Neutral to power supply via the N pin on the input side of the driver.

3 Thread the pendant suspension cables through the ceiling bracket cover and suspension nuts:

- Insert the suspension cables through the holes on either side of the ceiling bracket cover. Position the cover on the flat top of the pendant.
- Thread the suspension cables through the suspension nuts attached to the ceiling bracket. Once the cables are the desired length tighten the grub screws using the tool provided.

4 Trim excess wire if required.

- Connect the pendant suspension cable (labelled '-') to the pin (labelled '-') on the output side of the driver.
- Connect the pendant suspension cable (labelled '+') to the pin (labelled '+') on the output side of the driver.

5 Attach the ceiling bracket to the ceiling using the provided wood screws. You will need two people for this part.

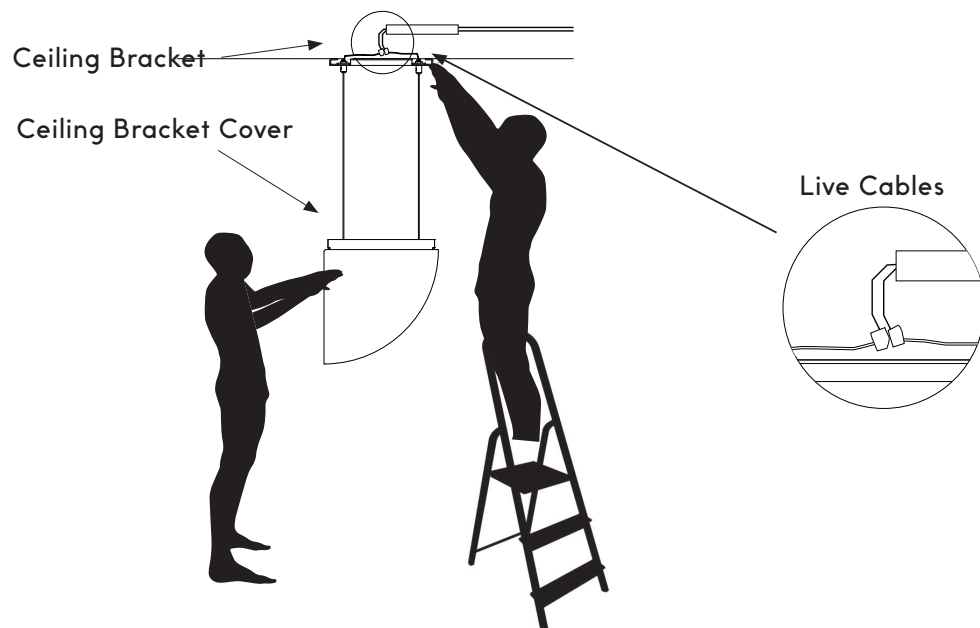

Phase Pendant Large Installation Instructions

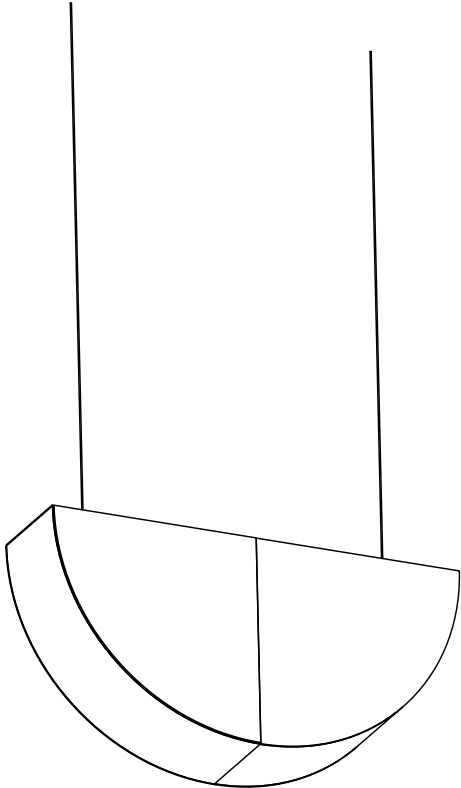

Resident

Phase Pendant Large Installation Instructions

Product Code: PHA02



Warning, installation must be completed by a certified Electrician only.

Assembly Kit Contents:

- 4 x Wago connector 2 pole
- 1 x Wago connector 3 pole
- 1 x 24V Driver
- 2 x Suspension Nuts
- 2 x Lock Nuts
- 2 x Nylon Grub Screws
- 1 x Ceiling Bracket
- 1 x Ceiling Bracket Cover
- 8 x Wood Screws
- 1 x Tool

This pendant is an LED luminaire, which requires an external driver to provide a 24V electricity source. The driver included in your purchase is Triac (Phasecut) dimmable. Other types of dimmable drivers are available for individual sale.

1 The Pendant can hang a maximum distance of 5 meters from the ceiling. If this light is being installed in the USA the driver will need to be placed in a UL registered enclosure. To install the light follow the instructions below:

- Create a cavity in the ceiling to accommodate the driver. Ensure the cavity does not exceed the dimensions of 240mm (9.4 inches) by 55mm (2.1 inches). This cavity should be aligned centrally with the ceiling bracket.
- If installing in the USA, cable entry should be in front of the UL registered enclosure. If required, this will need to be supplied by the installer.

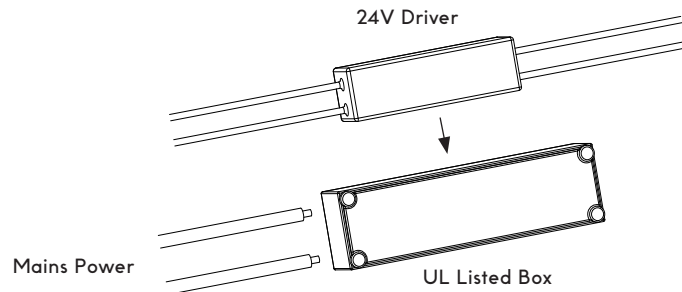

2 Connect the Driver to mains power:

- Connect the line of incoming mains Live to power supply, input Black cable of the driver using the two pole Wago connector.
- Connect the line of incoming mains Neutral to power supply, input White cable of the driver using two pole Wago connector.

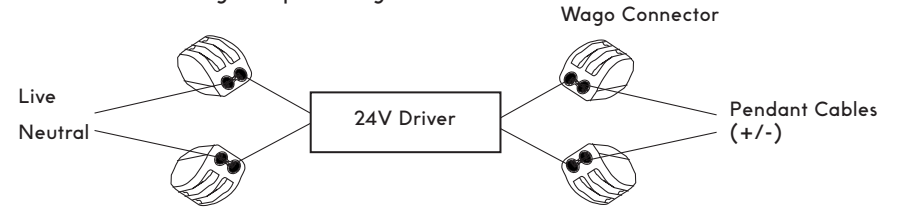

3 Thread the pendant suspension cables through the ceiling bracket cover and suspension nuts:

- Insert the suspension cables through the holes on either side of the ceiling bracket cover. Position the cover on the flat top of the pendant.
- Thread the suspension cables through the suspension nuts attached to the ceiling bracket. Once the cables are the desired length tighten the grub screws using the tool provided.

4 Attach the ceiling bracket to the ceiling using the provided wood screws. You will need two people for this part.

- Position the bracket so that the output wires of the driver fit through the central hole of the bracket.

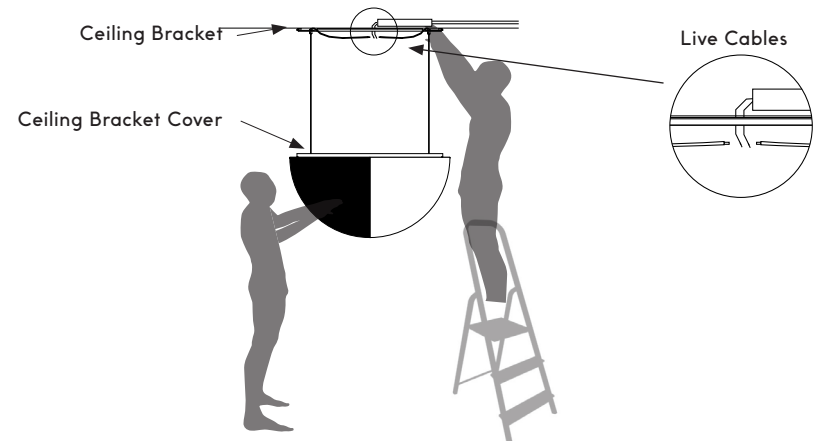

5 Trim excess wire if required.

- Connect the outgoing power supply Black cable to pendant suspension cable (labelled '-') using the two pole wago connector.
- Connect outgoing power supply Red cable to pendant suspension cable (labelled '+') using two pole wago connector.

6 Step back to check if the pendant is hanging correctly. Adjust cable lengths as needed by loosening the grub screws.

- If the light is hanging at an angle the suspension nut can be adjusted side ways by loosening the slots button screws. Ensure all fixings are tightened before proceeding.

For sloped ceilings, the pendant can hang at angles up to 30 degrees.

- Once the pendant is suspended loosen the suspension nuts using the wrench side of the tool. Slide the suspension nuts along the bracket until the cables are vertically parallel. Tighten all fixings before moving on.

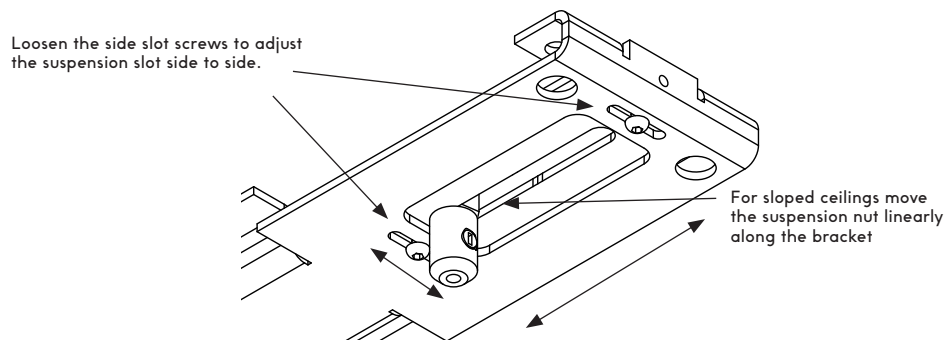

7 Connect the two green Earth cables from the ceiling bracket and the ceiling bracket cover to the Driver Earthing cable using the Wago connector with 3 poles.

8 Secure the ceiling bracket cover onto the ceiling bracket by aligning the side holes and using the two bracket screws provided.

Your pendant is now installed.