

## Instructions

# Mist AP15

## All the Way to Paris

### 2023

---



Congratulations on your new Mist lamp, designed in 2023 by All the Way to Paris. We hope you will enjoy using this lamp. Please follow these instructions to ensure correct installation. If you have any questions or comments, please do not hesitate to contact us by mail at: [info@andtradition.com](mailto:info@andtradition.com)

**&Tradition®**

# Mist AP15

## All the Way to Paris 2023

Please read these instructions carefully and keep them for future reference to ensure that the product is used correctly. For your own safety, please study each step of this instruction manual first. &Tradition is not responsible for any faults or damage caused by not following these instructions correctly. Do not modify this product in any way.

### Contents

- A Metal lamp holder
- B Shade
- C Canopy with metal ceiling bracket
- D Connection box

### Tools needed

- Bulb type G9
- Small flat headed screwdriver for wiring

### Safety precautions

- Dispose of plastic bag from packaging and keep out of reach of children.
- Keep product well out of children's reach.
- The lamp is only intended for interior use.
- Do not attempt installation of product if you are not competent to do so yourself.
- Consult a professionally qualified electrician if in any doubt.

### Cleaning instructions

- Wipe surface of lamp shade with a soft, damp sponge or cloth.
- Do not use any abrasive cleaning tools such as steel wool, scouring sponges or stiff brushes.
- Never use strong cleaning agents such as white spirit, turpentine, household glass cleaner or cellulose thinners.

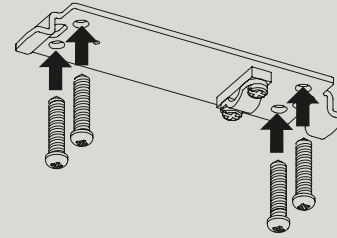
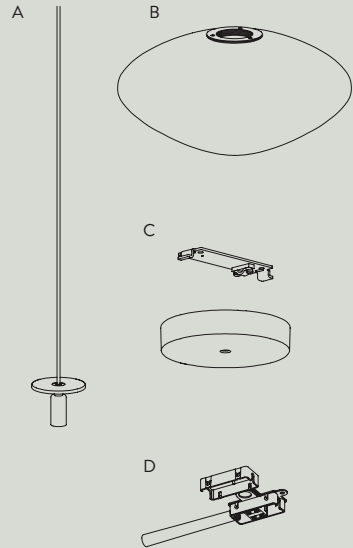

### Step 1

Ensure power supply is turned off and remove any existing lamp fitting.  
Locate the supply cable and ensure it is ready to be fitted to the connector block.  
Mount the metal bracket (C) securely in the ceiling with screws and wall plugs, appropriate for the ceiling of installation.

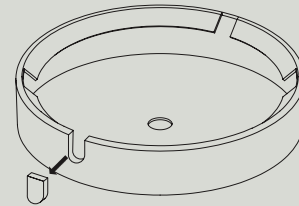

### Step 2

Use the marked up area in the canopy to make a hole in it for the cord outlet.

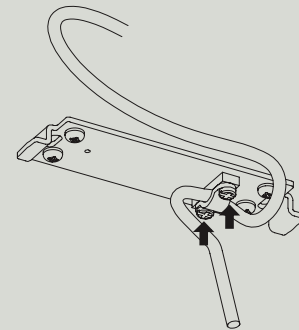

### Step 3

To determine the right suspension height for the lamp, pass the electrical cord through the strain relief of the metal bracket (C). When you have the desired suspension height of the lamp, tighten the two screws of the strain relief.

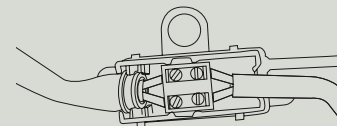

### Step 4

Use the terminal box inside the connection box (D) to assemble the wires from the pendant with the wires from the power supply. Close the connection box and place it inside the canopy.

For indoor use only  
G9 maximum 20W  
Bulb not included

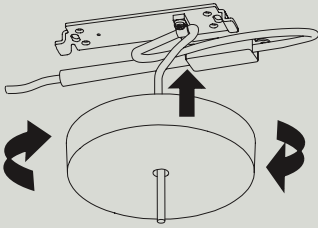

### Step 5

Screw the canopy onto the metal bracket.

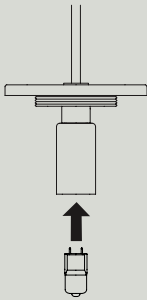

### Step 6

Install the light bulb.

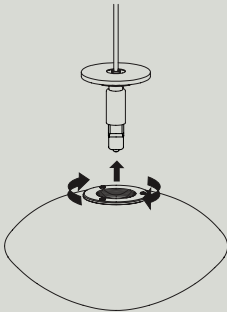

### Step 7

Mount the shade onto the metal lamp holder, by carefully screwing it on.

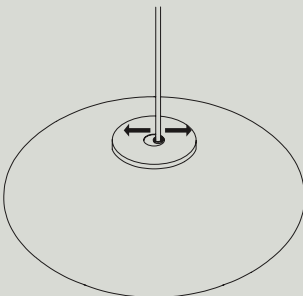

### Step 8

Carefully move the cord at the top of the metal lamp holder to adjust the lamp while making sure that the shade is hanging straight.

## Instructions

# Mist AP16

## All the Way to Paris

### 2023

---

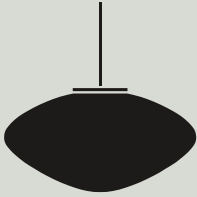

Congratulations on your new Mist lamp, designed in 2023 by All the Way to Paris. We hope you will enjoy using this lamp. Please follow these instructions to ensure correct installation. If you have any questions or comments, please do not hesitate to contact us by mail at: [info@andtradition.com](mailto:info@andtradition.com)

**&Tradition®**

# Mist AP16

## All the Way to Paris 2023

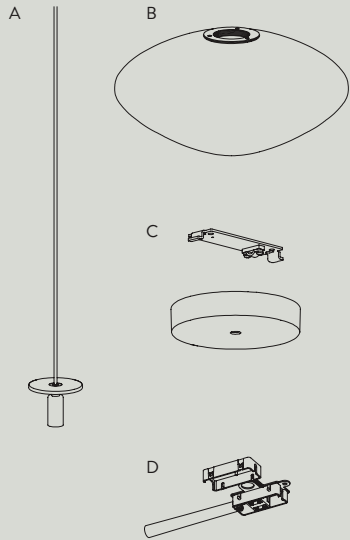

Please read these instructions carefully and keep them for future reference to ensure that the product is used correctly. For your own safety, please study each step of this instruction manual first. &Tradition is not responsible for any faults or damage caused by not following these instructions correctly. Do not modify this product in any way.

### Contents

- A Metal lamp holder
- B Shade
- C Canopy with metal ceiling bracket
- D Connection box

### Tools needed

- Bulb type E27
- Small flat headed screwdriver for wiring

### Safety precautions

- Dispose of plastic bag from packaging and keep out of reach of children.
- Keep product well out of children's reach.
- The lamp is only intended for interior use.
- Do not attempt installation of product if you are not competent to do so yourself.
- Consult a professionally qualified electrician if in any doubt.

### Cleaning instructions

- Wipe surface of lamp shade with a soft, damp sponge or cloth.
- Do not use any abrasive cleaning tools such as steel wool, scouring sponges or stiff brushes.
- Never use strong cleaning agents such as white spirit, turpentine, household glass cleaner or cellulose thinners.

For indoor use only  
E27 maximum 40W  
Bulb not included

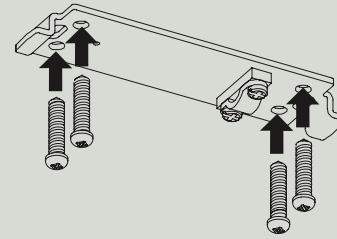

### Step 1

Ensure power supply is turned off and remove any existing lamp fitting.  
Locate the supply cable and ensure it is ready to be fitted to the connector block.  
Mount the metal bracket (C) securely in the ceiling with screws and wall plugs, appropriate for the ceiling of installation.

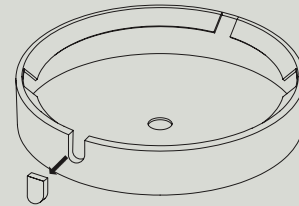

### Step 2

Use the marked up area in the canopy to make a hole in it for the cord outlet.

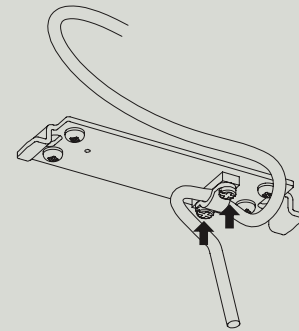

### Step 3

To determine the right suspension height for the lamp, pass the electrical cord through the strain relief of the metal bracket (C). When you have the desired suspension height of the lamp, tighten the two screws of the strain relief.

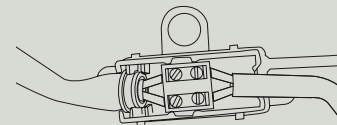

### Step 4

Use the terminal box inside the connection box (D) to assemble the wires from the pendant with the wires from the power supply. Close the connection box and place it inside the canopy.

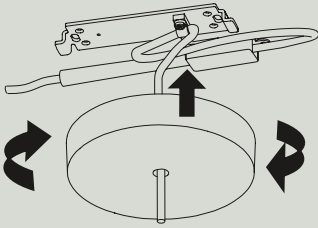

**Step 5**

Screw the canopy onto the metal bracket.

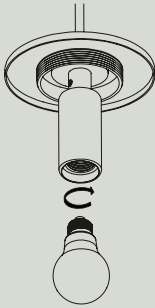

**Step 6**

Install the light bulb.

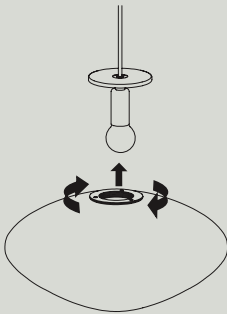

**Step 7**

Mount the shade onto the metal lamp holder, by carefully screwing it on.

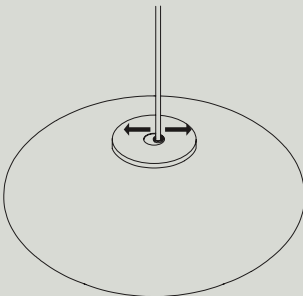

**Step 8**

Carefully move the cord at the top of the metal lamp holder to adjust the lamp while making sure that the shade is hanging straight.