

VIBIA

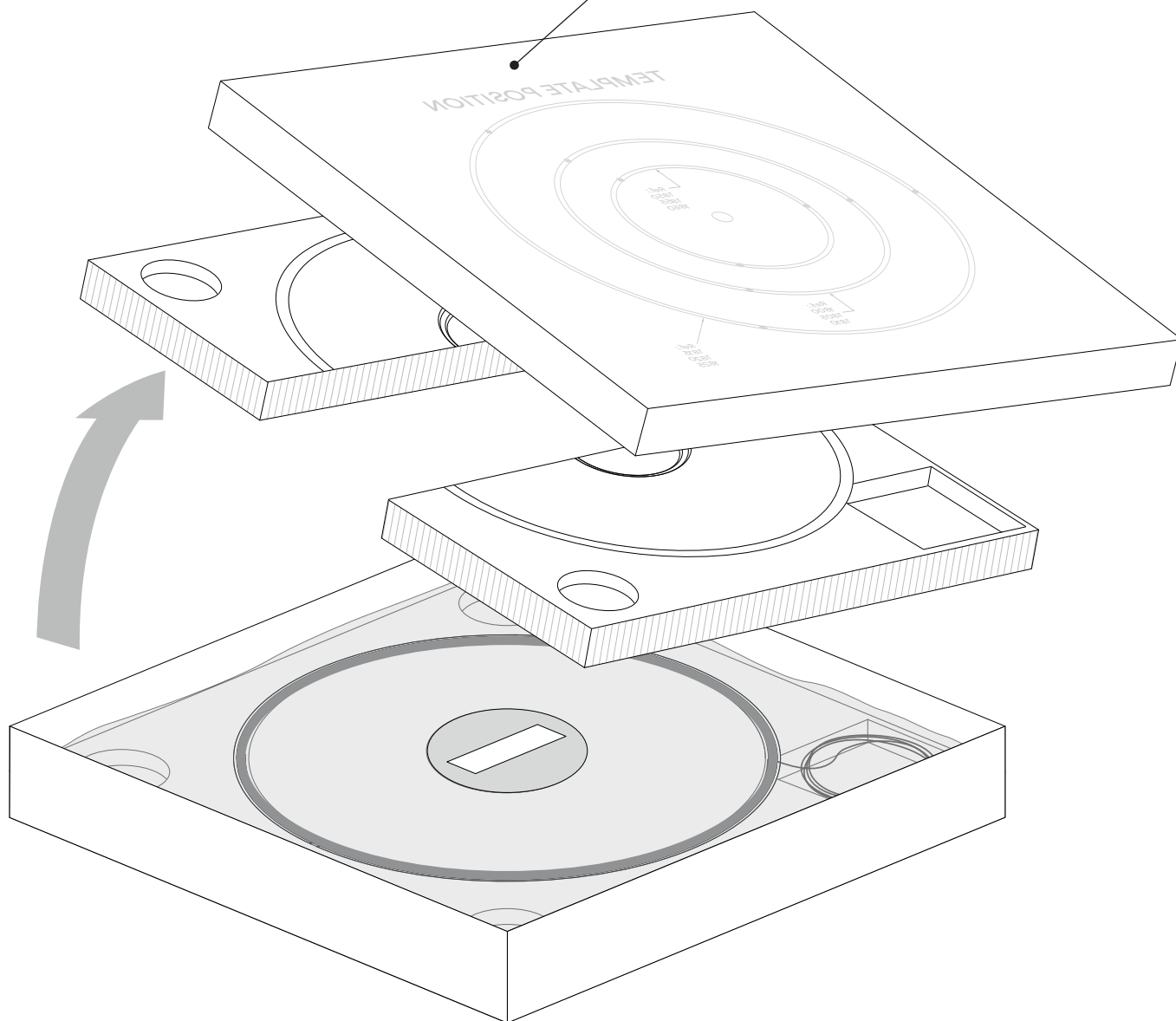

- Keep the template
- Conserver l'outil de marquage



VIBIA

Assembly instructions / Instructions de montage

Array

Design by Umut Yamac



Caution

Before assembling and installing this product, carefully read the following:

- CAUTION: To avoid possible electrical shock, make certain electricity is shut off at main panel before wiring.
- This product must be installed in accordance with the national and local electrical codes. If you are not familiar with wiring, you should use a qualified electrician to avoid hazards involved.
- To install on the ceiling, always choose the most adequate fixing tools for the ceiling material.
- This luminaire must be mounted or supported independently of an outlet box.
- If the steel cable or the power cord of this lamp is damaged, it must be replaced only by the manufacturer or their technical service or by a person capacitated to this effect to avoid any risk.
- This lamp is for indoor use only, excluding bathrooms or any type of humid surface.
- We recommend reading the manual before installing the lamp. Keep this instructions for future reference.
- Do not disassemble, modify or try to repair this fitting. In order to get technical assistance contact VIBIA. Any change or modification to the light fitting can null the manufacturer's guarantee.
- All electronic components and batteries must be taken to separate waste collection points at the end of their working lives, they must not be disposed of in normal household waste. It is the responsibility of the user to dispose of the equipment using a designated collection point or service for separate recycling of waste electrical and electronic equipment (WEEE) and batteries according to local laws.
-  **WARNING:** The products distributed by Vibia Inc. may contain chemicals known to the State of California to cause cancer and birth defects or other reproductive harms. For more information go to www.P65Warnings.ca.gov
- At least 2 people are needed to install and uninstall the lamp.



Attention

Avant de procéder à l'assemblage et à l'installation de ce luminaire, lisez attentivement les considérations suivantes:

- ATTENTION : avant de réaliser toute connexion électrique, vérifiez que le courant au compteur de votre installation est bien coupé, afin d'éviter de possibles décharges électriques.
- L'installation électrique de ce produit doit être conforme aux normes électriques nationales ou locales. Si vous n'êtes pas habitué aux travaux d'électricité, lors de cette installation, veuillez employer les services d'un électricien qualifié dans le but d'éviter les dangers qu'elle implique.
- Pour fixer le luminaire au plafond, utilisez les éléments de fixation les mieux adaptés au support.
- Ce luminaire doit être monté ou soutenu indépendamment d'une boîte de connexion.
- En cas de détérioration, le câble flexible ou cordon d'alimentation de ce luminaire ne devra être remplacé que par le fabricant, son service technique, ou toute autre personne de qualification équivalente, afin d'éviter tout risque.
- Ce luminaire ne convient que pour une utilisation en intérieur, sauf dans les salles de bains ou tout type de surface humide.
- Nous vous recommandons de lire le manuel avant de commencer l'installation du luminaire. Conservez ces instructions pour de futures consultations
- Ne démontez pas le luminaire, ne le modifiez pas et n'essayez pas de le réparer. Pour bénéficier d'une assistance technique, contactez VIBIA. Toute altération ou modification du luminaire peut annuler la garantie du fabricant.
- Tous les produits électroniques et toutes les batteries doivent être apportés à des points de collecte distincts de ceux des ordures ménagères normales lorsqu'ils arrivent en fin de vie. Il incombe à l'utilisateur de se débarrasser de l'équipement dans un point de collecte ou auprès d'un service spécifiquement désignés pour le recyclage des déchets électriques et des équipements électroniques (DEEE) ainsi que des batteries, dans le respect de la législation locale.
-  **ATTENTION :** Les produits distribués par Vibia Inc. peuvent contenir des substances chimiques reconnues par l'État de Californie comme étant cancérigènes, pouvant provoquer des malformations de naissance ou nuire à la reproduction. Pour plus de renseignements veuillez consulter www.P65Warnings.ca.gov
- Pour le montage et le démontage de ce luminaire, la présence de 2 personnes est recommandée.



Step 1
Product Spec Sheet



Step 2
Supplied Materials



Step 3
Installation Preparation



Step 4
Electrical Connection































































Step 5
Product Assembly



Step 1/5 Product Spec Sheet

Technical specifications / Caractéristiques techniques

| | |
|---|---|
|  | 1820 Height: 44.5 in  Net Weight: 14.5 lb.  1 x LED STRIP 33W 48V IP20 Dry Location Dimmer Multi-volt   50-60Hz |
|  | 1825 Height: 76 in  Net Weight: 15.6 lb.  1 x LED STRIP 33W 48V IP20 Dry Location Dimmer Multi-volt   50-60Hz |
|  | 1830 Height: 44.5 in  Net Weight: 20.9 lb.  1 x LED STRIP 50W 48V IP20 Dry Location Dimmer Multi-volt   50-60Hz |
|  | 1835 Height: 76 in  Net Weight: 22.2 lb.  1 x LED STRIP 50W 48V IP20 Dry Location Dimmer Multi-volt   50-60Hz |
|  | 1840 Height: 44.5 in  Net Weight: 28.8 lb.  1 x LED STRIP 76W 48V IP20 Dry Location Dimmer Multi-volt   50-60Hz |
|  | 1845 Height: 76 in  Net Weight: 30.6 lb.  1 x LED STRIP 76W 48V IP20 Dry Location Dimmer Multi-volt   50-60Hz |
|  | 1855 Height: 44 in  Net Weight: 13.4 lb.  1 x LED STRIP 33W 48V IP20 Dry Location Dimmer Multi-volt   50-60Hz |
|  | 1860 Height: 76 in  Net Weight: 14.3 lb.  1 x LED STRIP 33W 48V IP20 Dry Location Dimmer Multi-volt   50-60Hz |
|  | 1865 Height: 43.3 in  Net Weight: 19.4 lb.  1 x LED STRIP 50W 48V IP20 Dry Location Dimmer Multi-volt   50-60Hz |
|  | 1870 Height: 75.2 in  Net Weight: 20.7 lb.  1 x LED STRIP 50W 48V IP20 Dry Location Dimmer Multi-volt   50-60Hz |
|  | 1875 Height: 42.2 in  Net Weight: 26.2 lb.  1 x LED STRIP 76W 48V IP20 Dry Location Dimmer Multi-volt   50-60Hz |
|  | 1880 Height: 74.8 in  Net Weight: 28.2 lb.  1 x LED STRIP 76W 48V IP20 Dry Location Dimmer Multi-volt   50-60Hz |

Dry Location

This lamp is for indoor use only, excluding bathrooms or any type of damp surface.

Cette lampe est exclusivement destinée à une utilisation en intérieur, à l'exclusion des salles de bain et de tout type de surface humide.

IP20

Product protected against solid object as big as or bigger than 1/2". No protection against water.

Produit protégé contre les intrusions de corps solides de taille égale ou supérieure à 1/2". Non protégé contre l'eau.

Multi-volt

Voltage range
Gamme de tension
100-277V



Alternating current
Courant alternatif
50/60Hz



Step 2/5

Supplied Materials

Supplied material / Matériel fourni

| | |
|---|-------|
| 1. Allen key / Clé Allen | 1 un. |
| 2. Assembly tool / Pièce d'assemblage | 1 un. |
| 3. Driver / Driver | 1 un. |
| 4. Components Bag / Sachet d'accessoires | 1 un. |
| 5. Lighting fixture / Structure du luminaire | 1 un. |
| 6. Template / Outil de marquage | 1 un. |
| 7. Assembly Built-in / Installation encastrée | 1 un. |

1



2

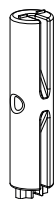

3



4

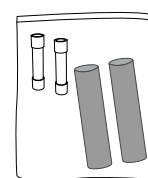

5

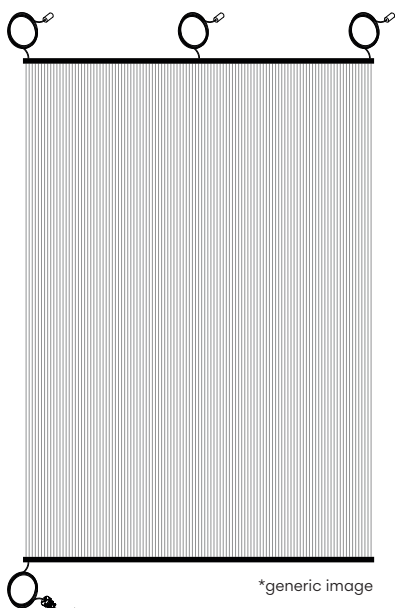

6

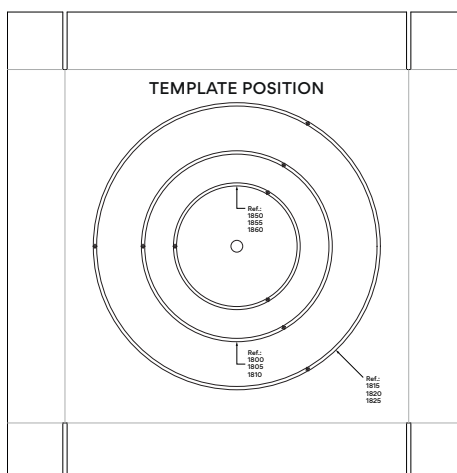

7

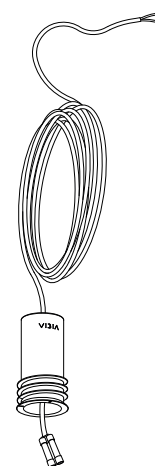



Step 3/5 Installation Preparation

3.1

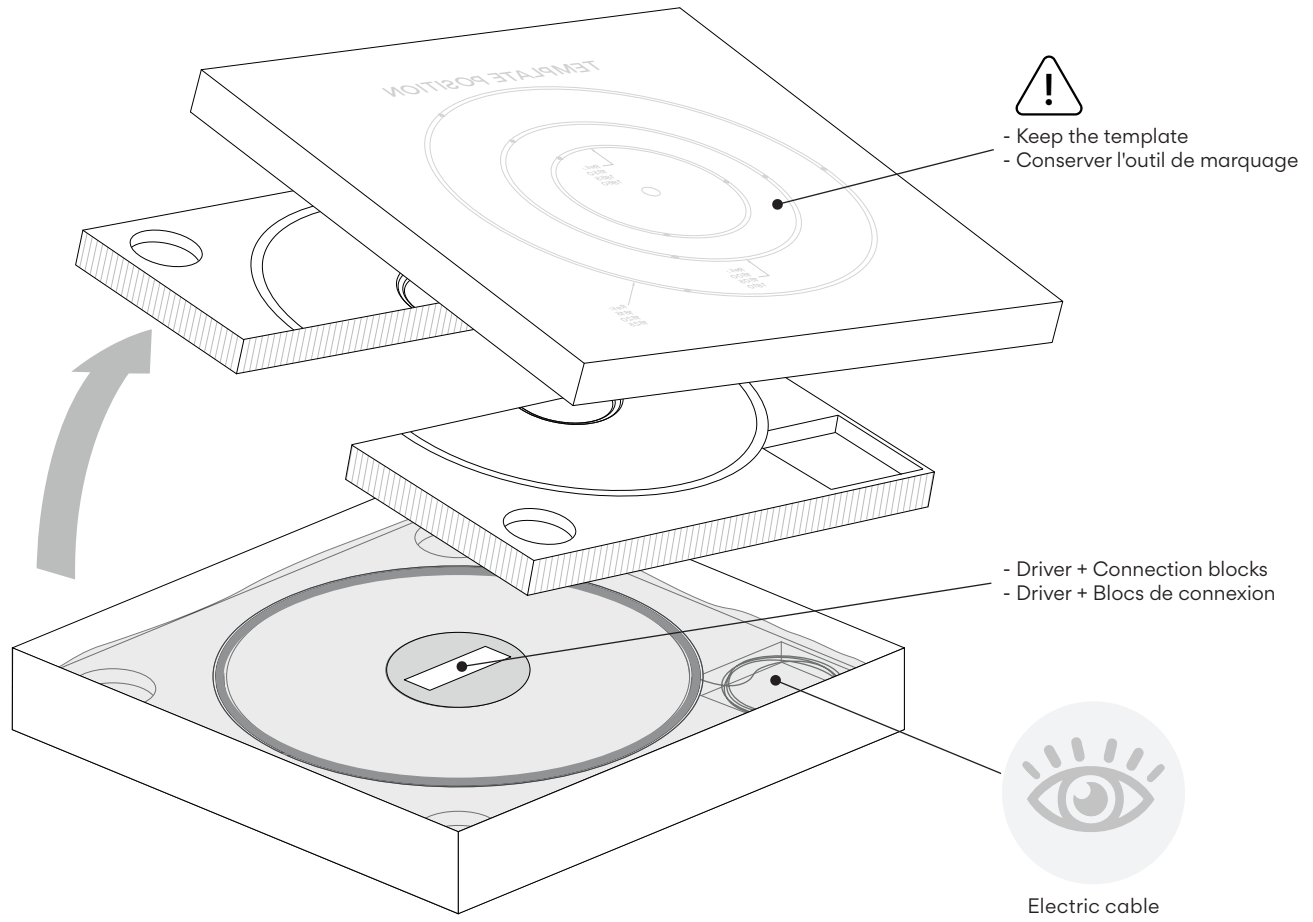

3.2

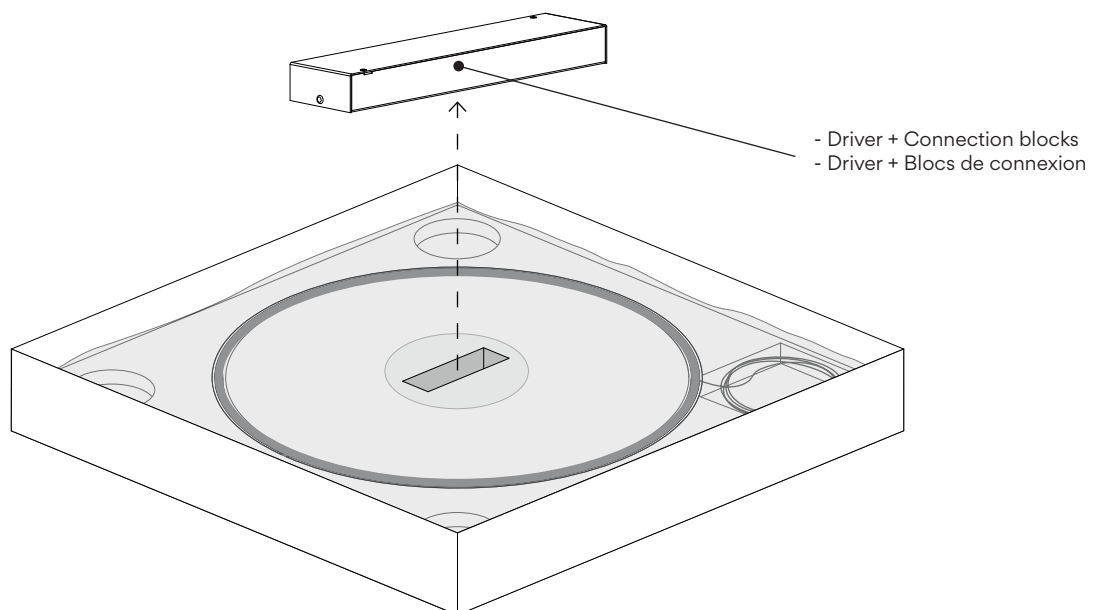



Step 3/5 Installation Preparation

3.3

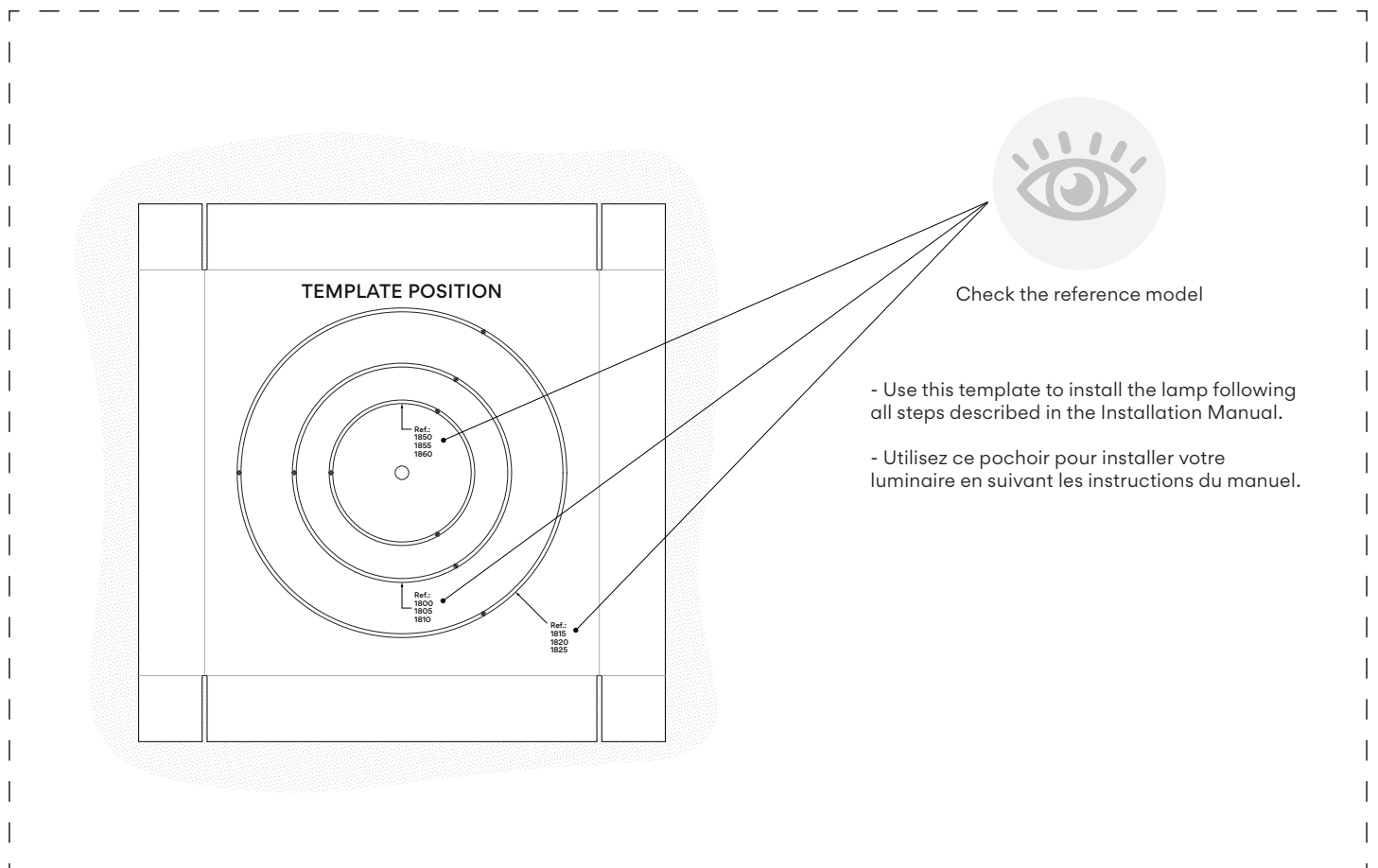
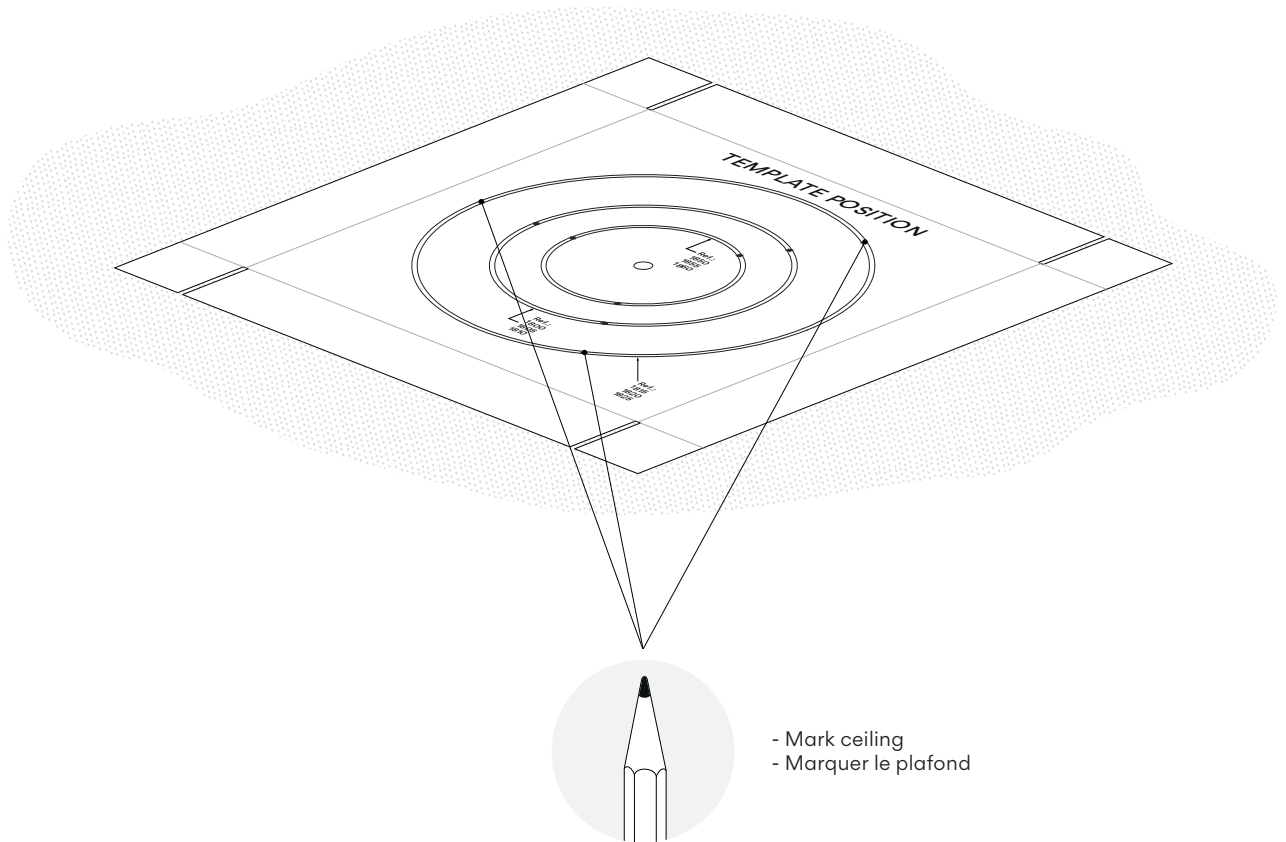



Step 4/5 Electrical Connection

4.1

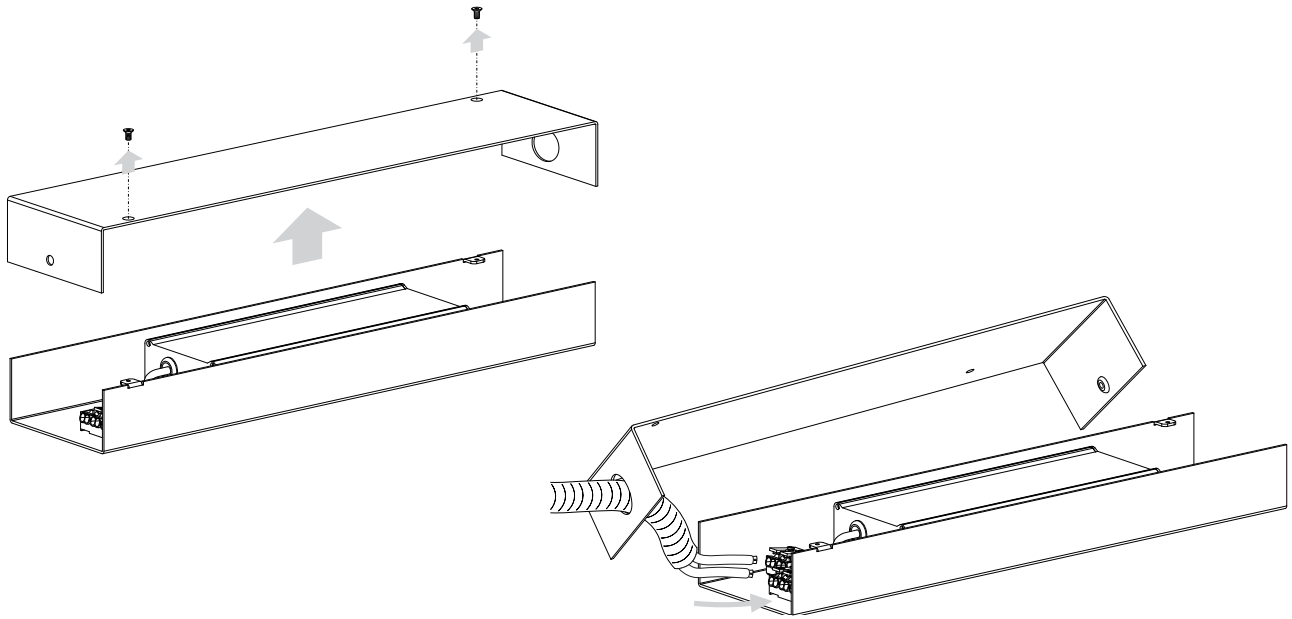

- VERY IMPORTANT: Make sure before making the connection that the power supply to your installation is disconnected.
- TRÈS IMPORTANT: Assurez-vous que le courant électrique de votre installation est coupé avant de connecter.

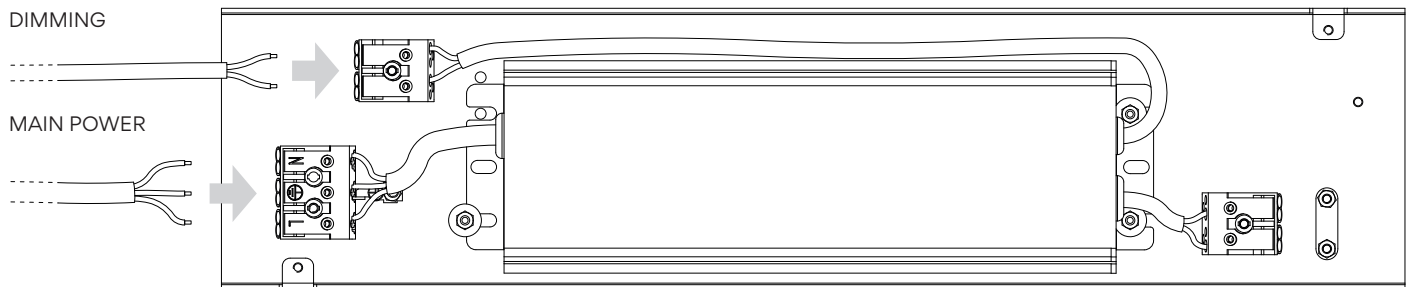

0-10V SYSTEM DIMMING

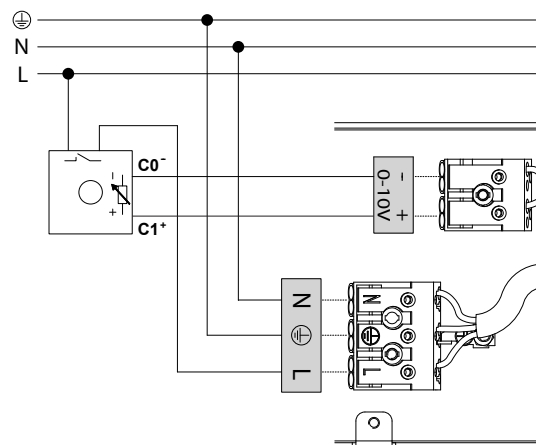



Step 4/5 Electrical Connection

4.2

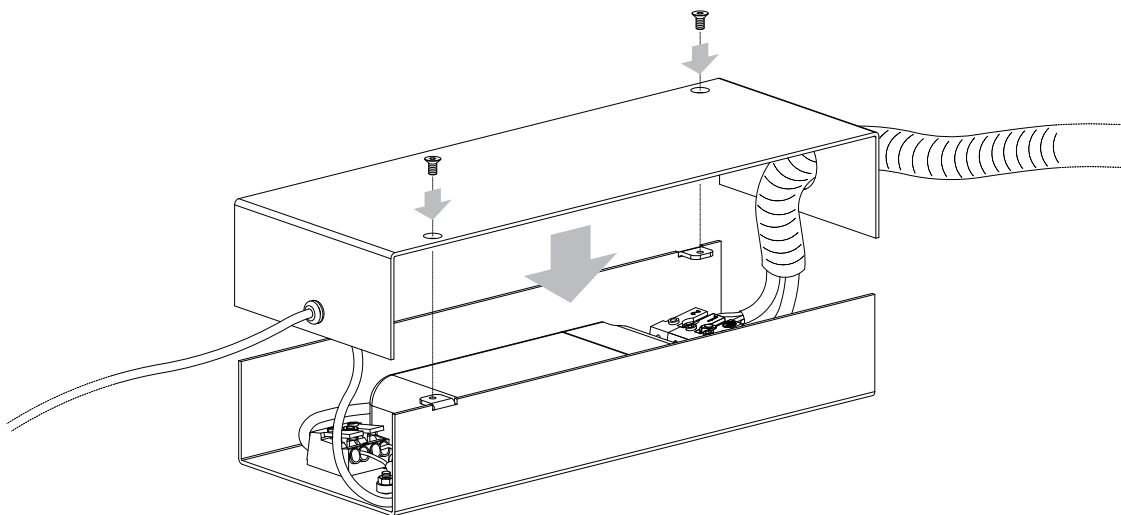
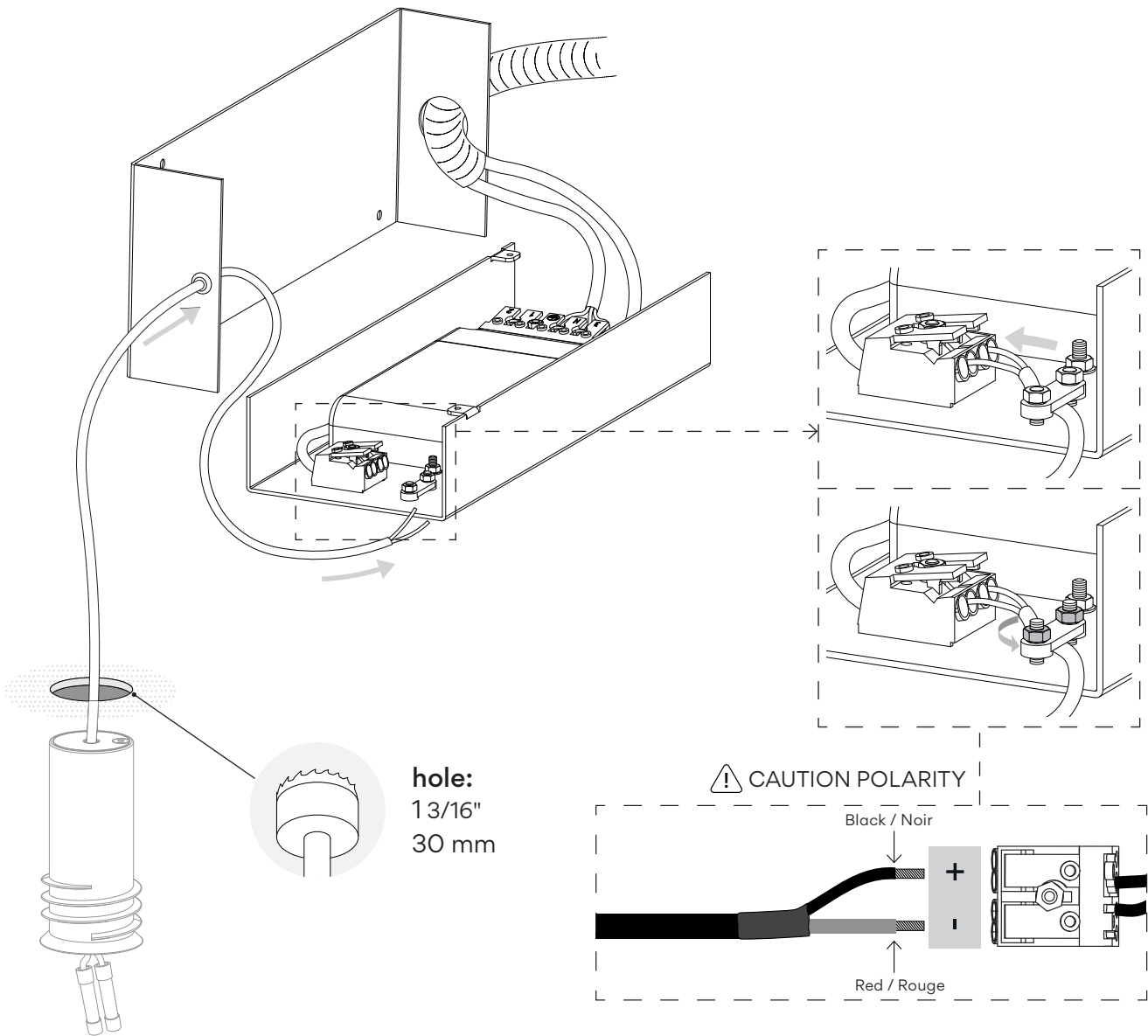



Step 4/5 Electrical Connection

4.3

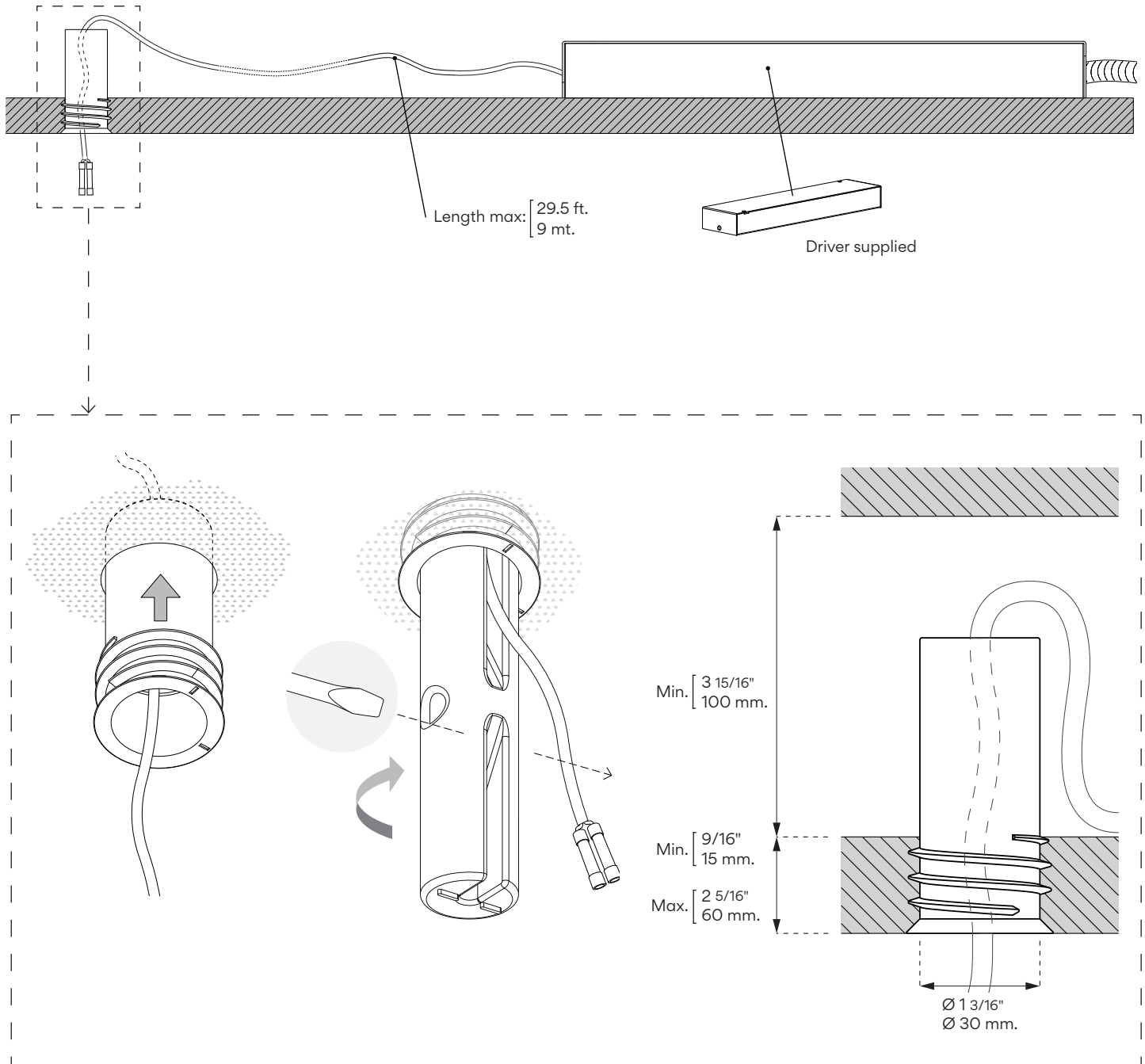



Step 5/5
Product Assembly

5.1

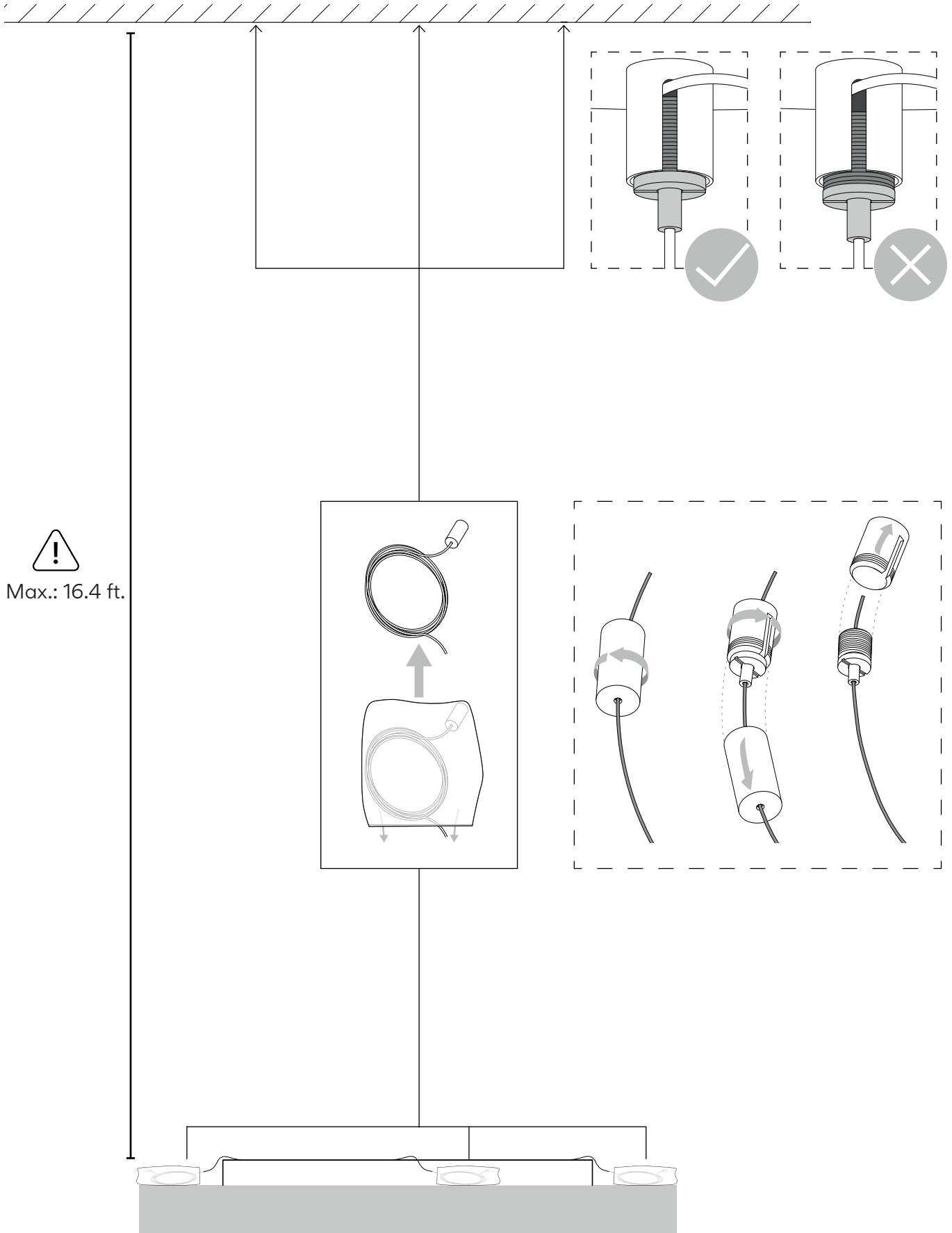



Step 5/5 Product Assembly

5.2

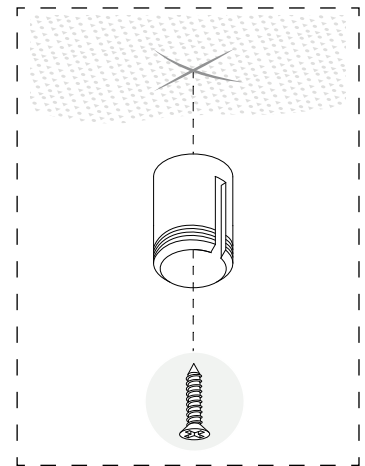
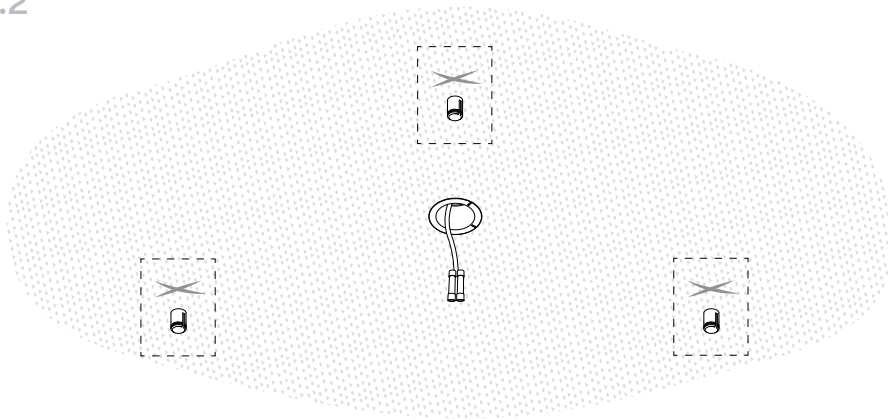

- Screws (not supplied)
- Vis (non fournies)

5.3

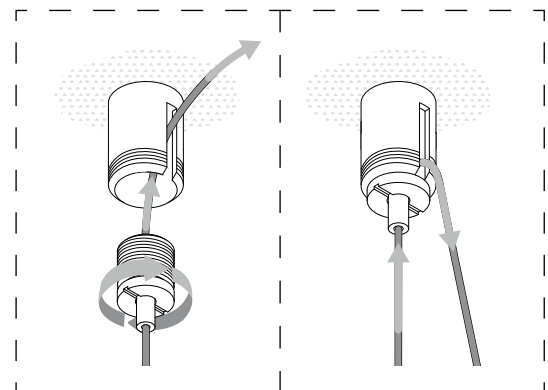

 Steel cable length = 32.8 ft.



Step 5/5 Product Assembly

5.4

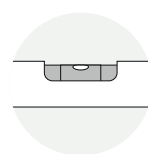
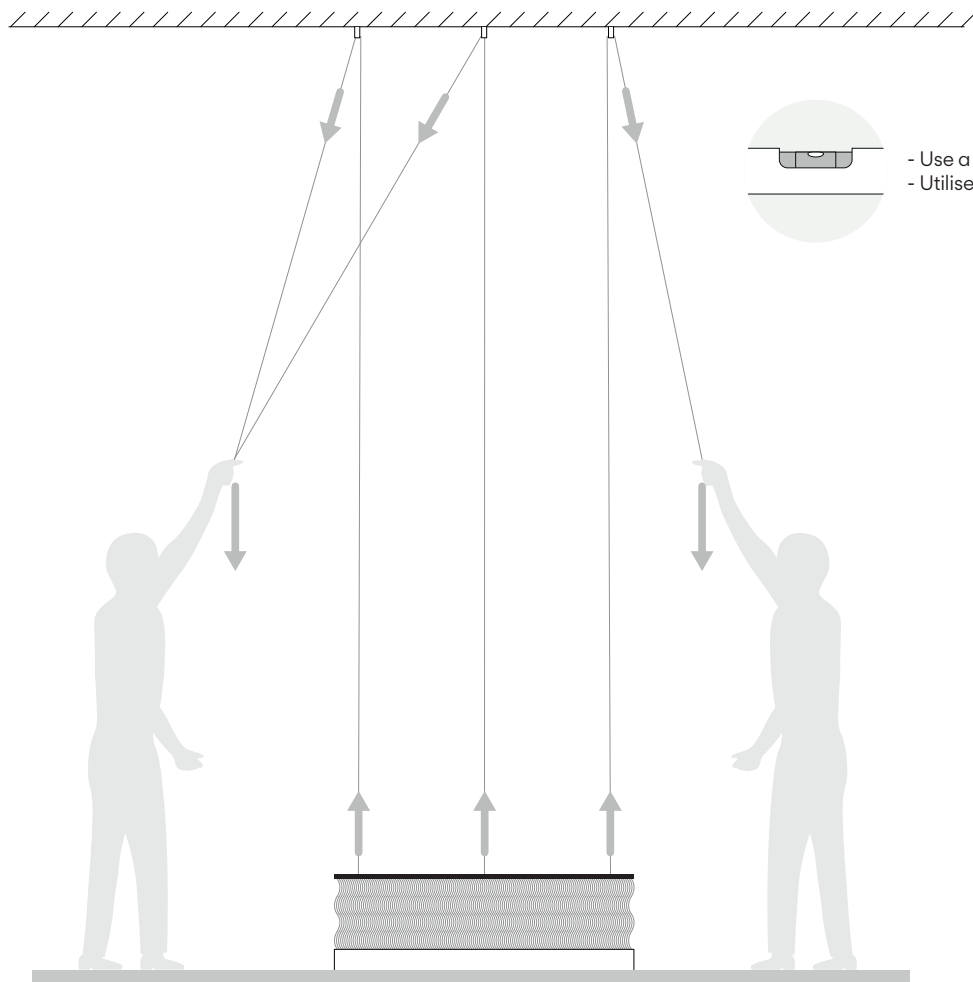

- Use a spirit level (not supplied)
- Utiliser un niveau à bulle (non fournies)

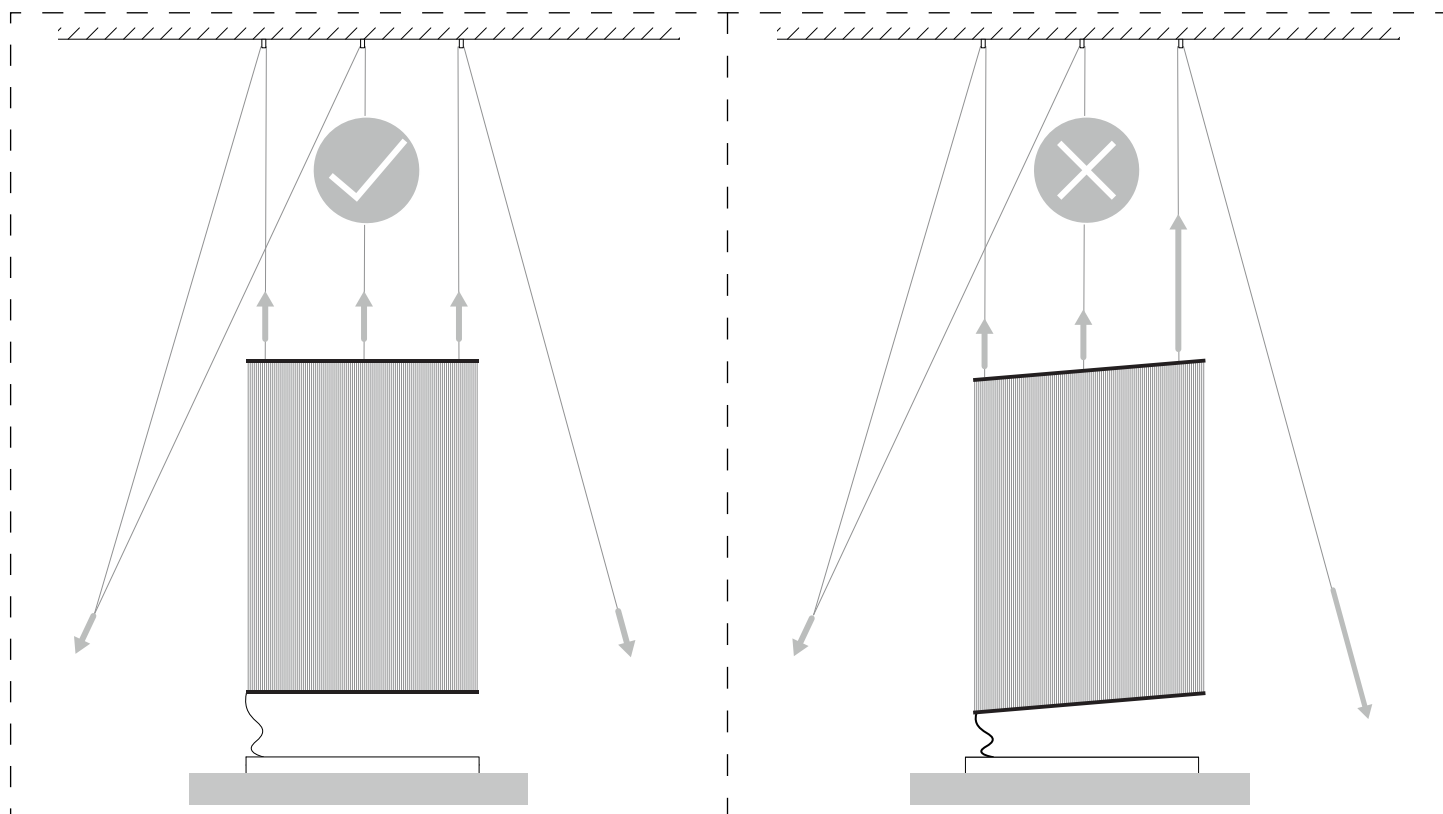



Step 5/6 Product Assembly

5.5

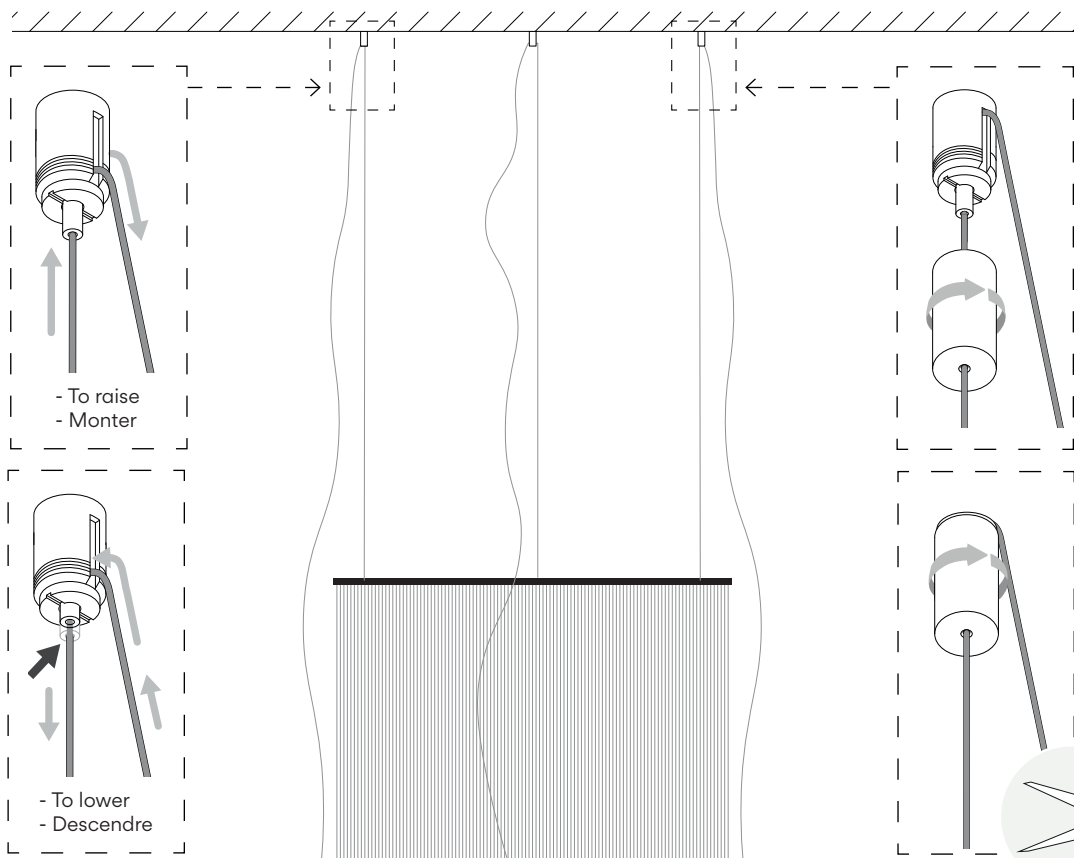
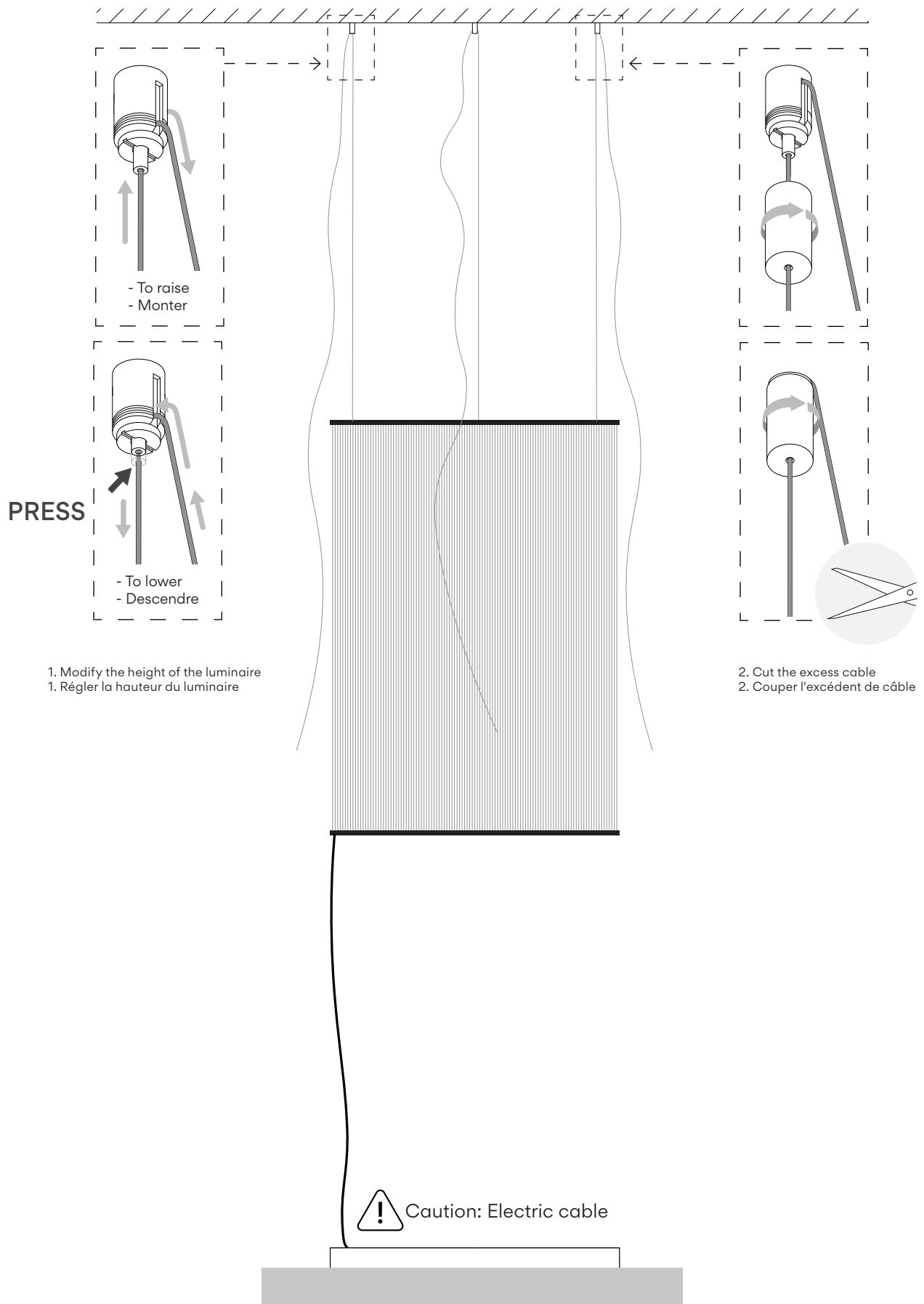



Step 5/6 Product Assembly

5.6

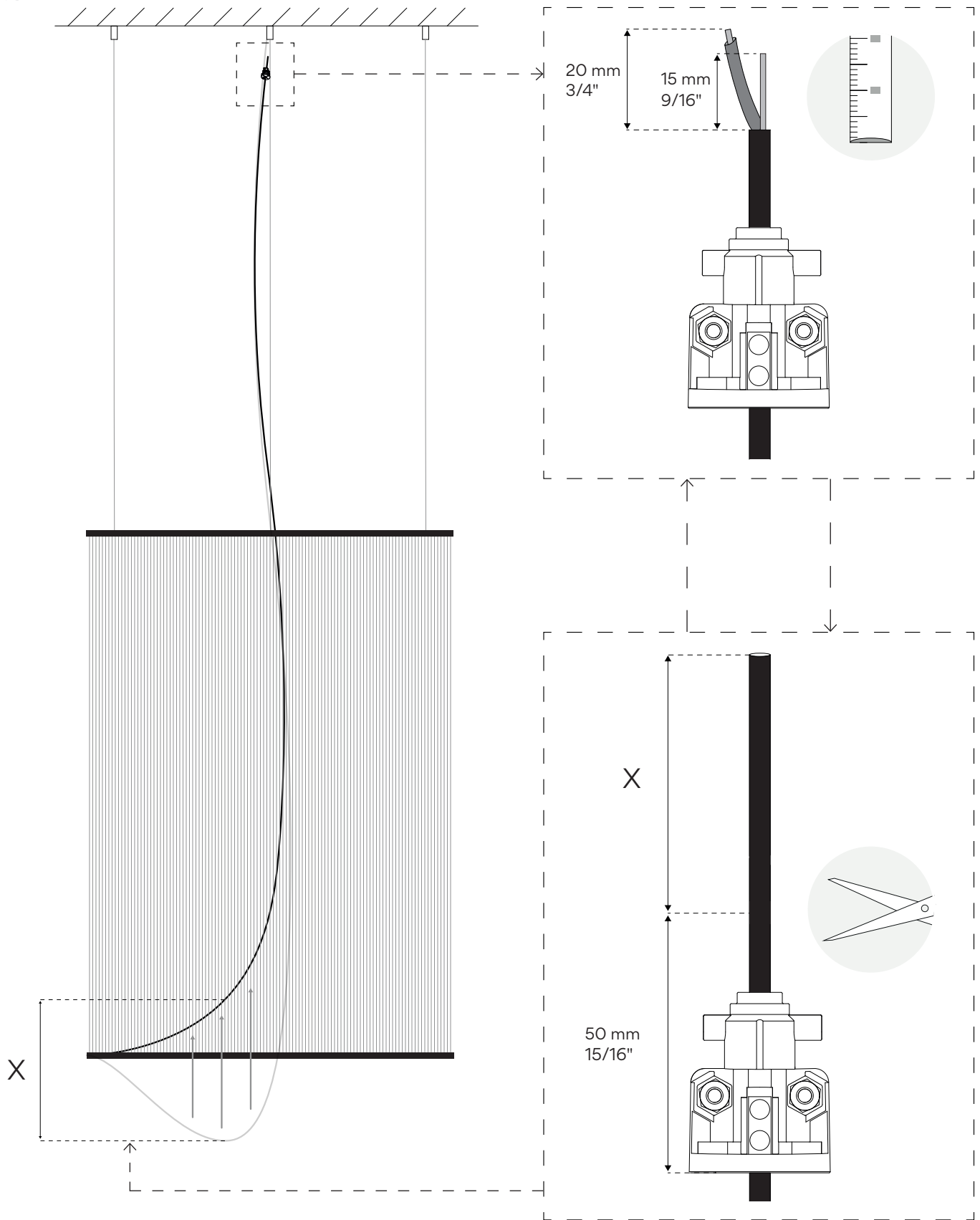



Step 5/6 Product Assembly

5.7

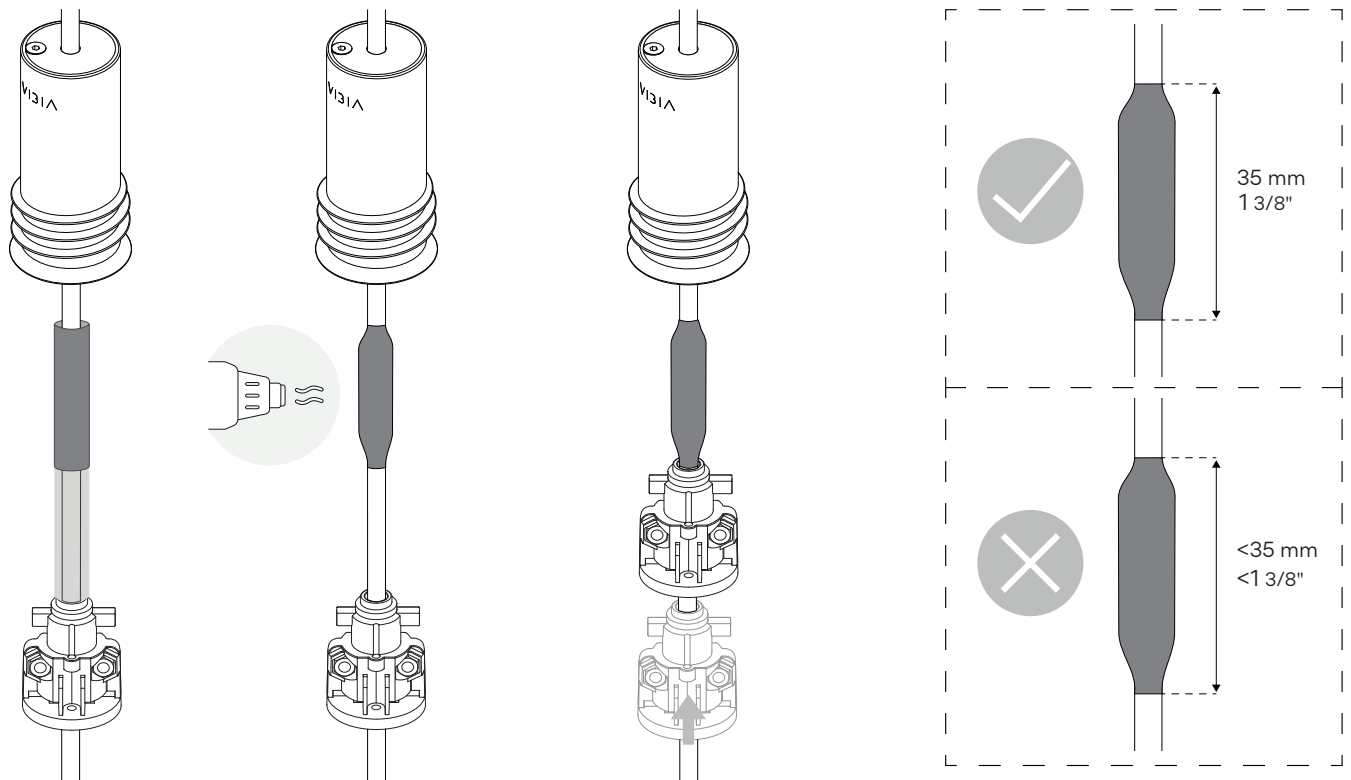
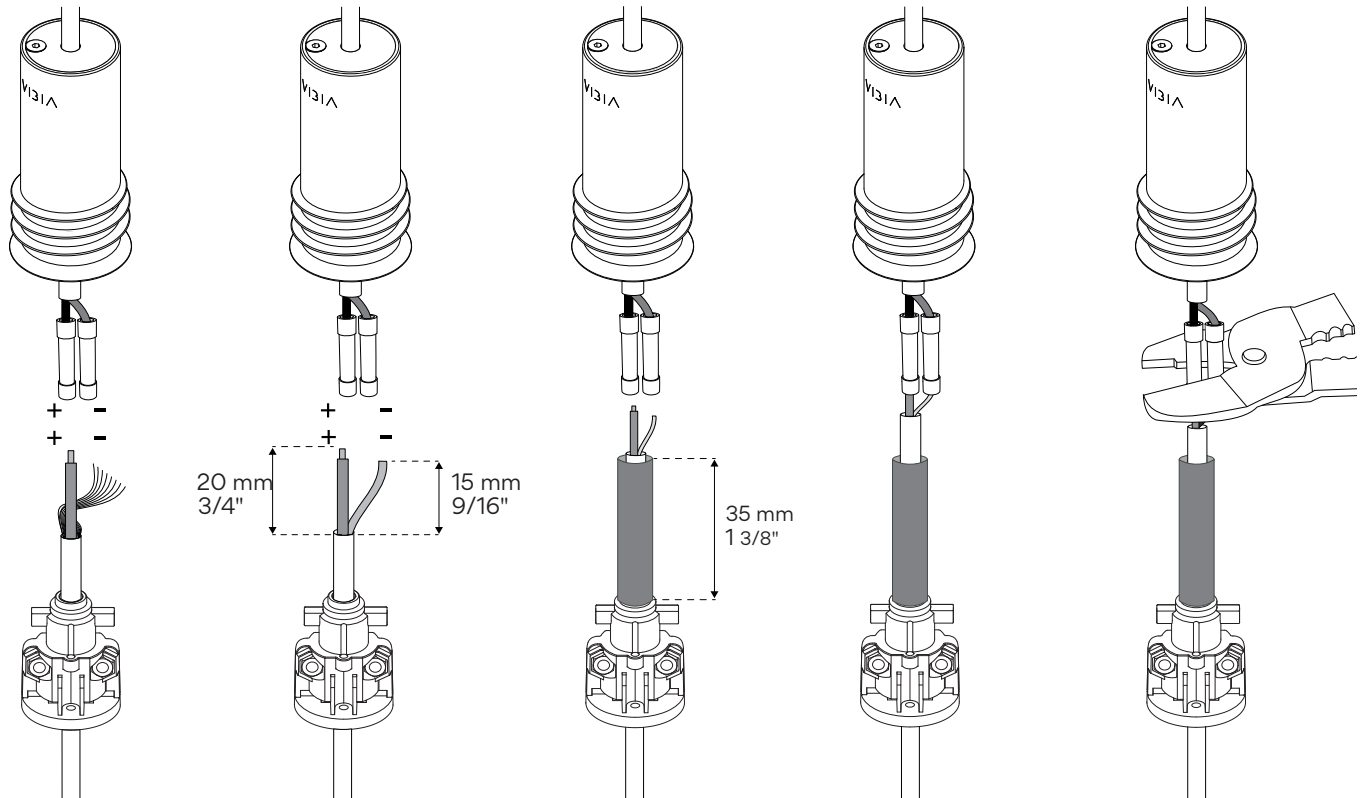



Step 5/6 Product Assembly

5.8

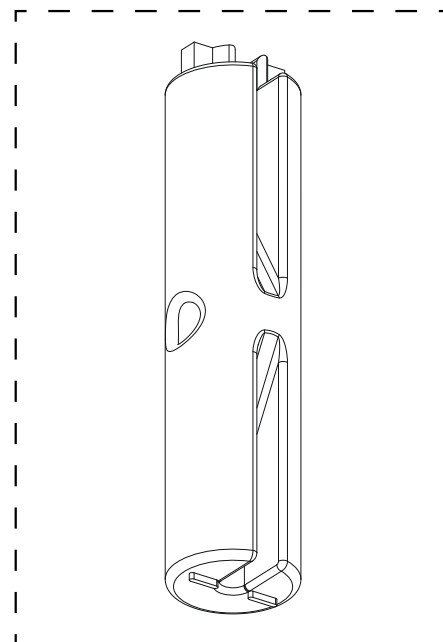
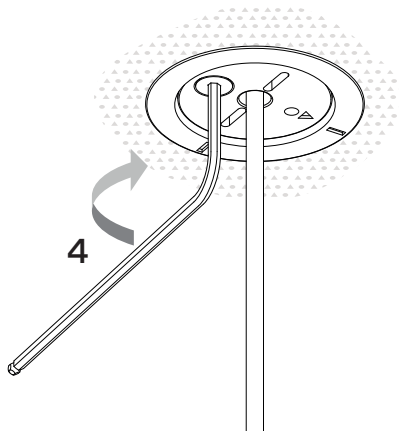
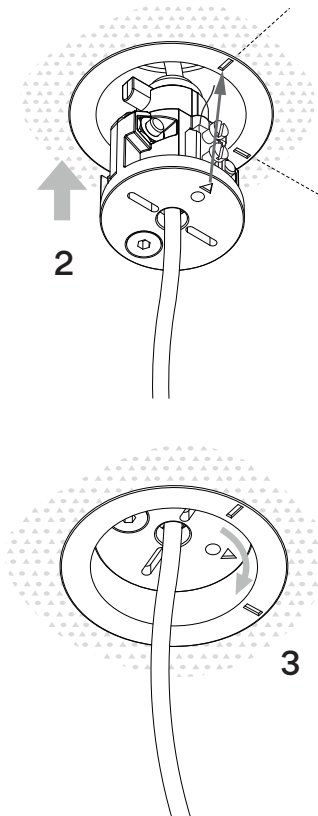
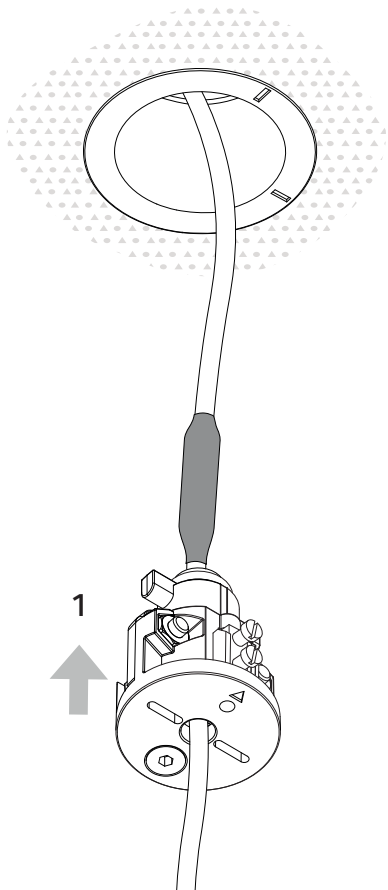

- Assembly tool
- Pièce d'assemblage

Maintenance

Use a damp cotton cloth for cleaning.
In case of malfunction or damage, please contact the distributor
who sold the lamp.

Entretien

Pour nettoyer le luminaire, utilisez un chiffon en coton légèrement
humidifié d'eau.
En cas d'incident ou de non fonctionnement du luminaire, con-
tactez directement l'établissement où vous l'avez acheté.

VIBIA. INC.

272 Fernwood Ave.
Edison, NJ 08837 . USA
Phone 732 417 1700.
Fax 732 417 1701.
sales@vibialight.com
www.vibia.com

VIBIA

VIBIA



- Keep the template
- Conserver l'outil de marquage

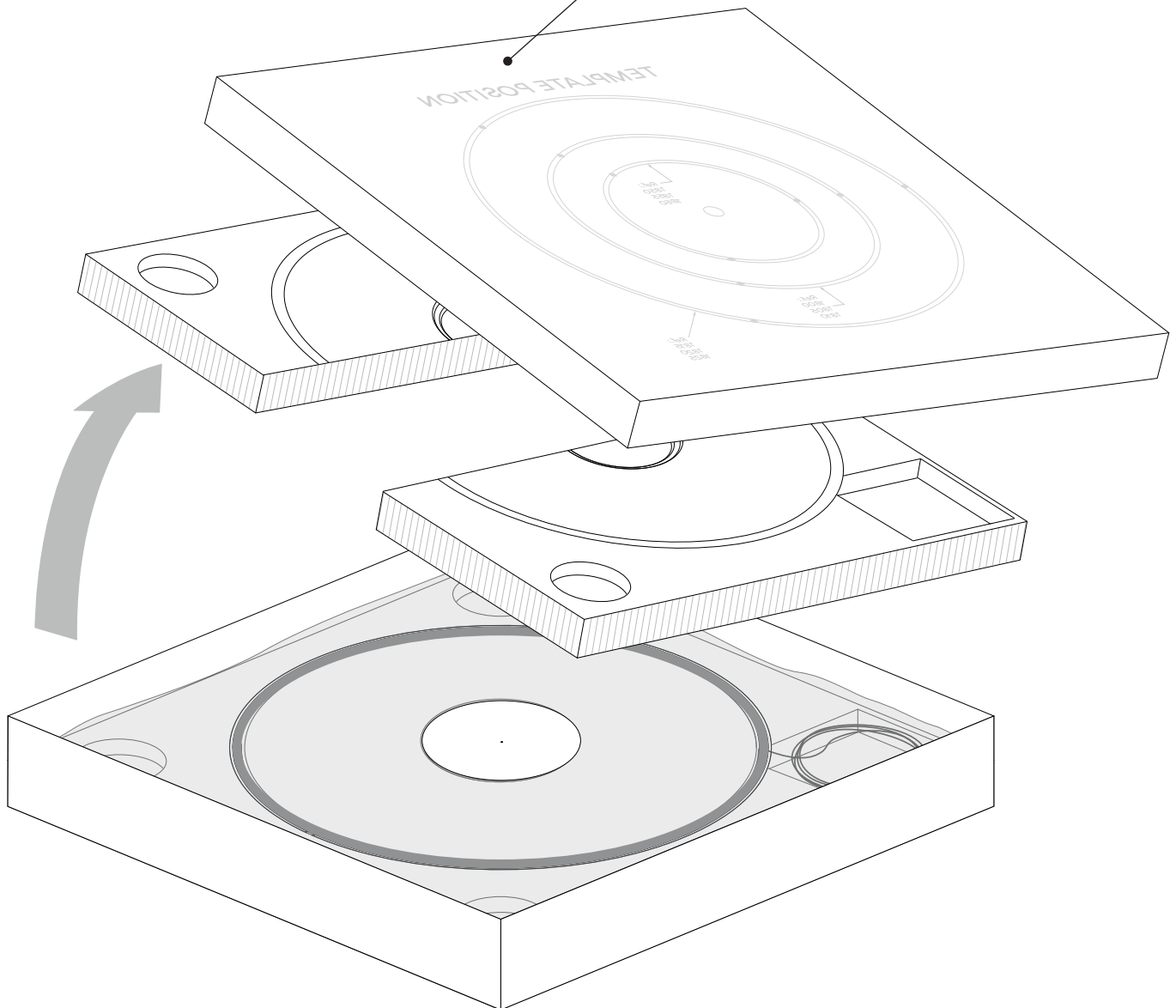

VIBIA

Assembly instructions / Instructions de montage

Array

Design by Umut Yamac



Caution

Before assembling and installing this product, carefully read the following:

- CAUTION: To avoid possible electrical shock, make certain electricity is shut off at main panel before wiring.
- This product must be installed in accordance with the national and local electrical codes. If you are not familiar with wiring, you should use a qualified electrician to avoid hazards involved.
- To install on the ceiling, always choose the most adequate fixing tools for the ceiling material.
- This luminaire must be mounted or supported independently of an outlet box.
- If the steel cable or the power cord of this lamp is damaged, it must be replaced only by the manufacturer or their technical service or by a person capacitated to this effect to avoid any risk.
- This lamp is for indoor use only, excluding bathrooms or any type of humid surface.
- We recommend reading the manual before installing the lamp. Keep this instructions for future reference.
- Do not disassemble, modify or try to repair this fitting. In order to get technical assistance contact VIBIA. Any change or modification to the light fitting can null the manufacturer's guarantee.
- All electronic components and batteries must be taken to separate waste collection points at the end of their working lives, they must not be disposed of in normal household waste. It is the responsibility of the user to dispose of the equipment using a designated collection point or service for separate recycling of waste electrical and electronic equipment (WEEE) and batteries according to local laws.
-  WARNING: The products distributed by Vibia Inc. may contain chemicals known to the State of California to cause cancer and birth defects or other reproductive harms. For more information go to www.P65Warnings.ca.gov
- At least 2 people are needed to install and uninstall the lamp.



Attention

Avant de procéder à l'assemblage et à l'installation de ce luminaire, lisez attentivement les considérations suivantes:

- ATTENTION : avant de réaliser toute connexion électrique, vérifiez que le courant au compteur de votre installation est bien coupé, afin d'éviter de possibles décharges électriques.
- L'installation électrique de ce produit doit être conforme aux normes électriques nationales ou locales. Si vous n'êtes pas habitué aux travaux d'électricité, lors de cette installation, veuillez employer les services d'un électricien qualifié dans le but d'éviter les dangers qu'elle implique.
- Pour fixer le luminaire au plafond, utilisez les éléments de fixation les mieux adaptés au support.
- Ce luminaire doit être monté ou soutenu indépendamment d'une boîte de connexion.
- En cas de détérioration, le câble flexible ou cordon d'alimentation de ce luminaire ne devra être remplacé que par le fabricant, son service technique, ou toute autre personne de qualification équivalente, afin d'éviter tout risque.
- Ce luminaire ne convient que pour une utilisation en intérieur, sauf dans les salles de bains ou tout type de surface humide.
- Nous vous recommandons de lire le manuel avant de commencer l'installation du luminaire. Conservez ces instructions pour de futures consultations
- Ne démontez pas le luminaire, ne le modifiez pas et n'essayez pas de le réparer. Pour bénéficier d'une assistance technique, contactez VIBIA. Toute altération ou modification du luminaire peut annuler la garantie du fabricant.
- Tous les produits électroniques et toutes les batteries doivent être apportés à des points de collecte distincts de ceux des ordures ménagères normales lorsqu'ils arrivent en fin de vie. Il incombe à l'utilisateur de se débarrasser de l'équipement dans un point de collecte ou auprès d'un service spécifiquement désignés pour le recyclage des déchets électriques et des équipements électroniques (DEEE) ainsi que des batteries, dans le respect de la législation locale.
-  ATTENTION : Les produits distribués par Vibia Inc. peuvent contenir des substances chimiques reconnues par l'État de Californie comme étant cancérigènes, pouvant provoquer des malformations de naissance ou nuire à la reproduction. Pour plus de renseignements veuillez consulter www.P65Warnings.ca.gov
- Pour le montage et le démontage de ce luminaire, la présence de 2 personnes est recommandée.



Step 1
Product Spec Sheet



Step 2
Supplied Materials



Step 3
Installation Preparation



Step 4
Electrical Connection



Step 5
Product Assembly































































Step 6
Adjustments & Maintenance



Step 1/6 Product Spec Sheet

Technical specifications / Caractéristiques techniques

| | |
|---|---|
|  | 1820 Height: 44.5 in  Net Weight: 14.5 lb.  1 x LED STRIP 33W 48V IP20 Multi-volt Dimmer Dry Location   50-60Hz |
|  | 1825 Height: 76 in  Net Weight: 15.6 lb.  1 x LED STRIP 33W 48V IP20 Multi-volt Dimmer Dry Location   50-60Hz |
|  | 1830 Height: 44.5 in  Net Weight: 20.9 lb.  1 x LED STRIP 50W 48V IP20 Multi-volt Dimmer Dry Location   50-60Hz |
|  | 1835 Height: 76 in  Net Weight: 22.2 lb.  1 x LED STRIP 50W 48V IP20 Multi-volt Dimmer Dry Location   50-60Hz |
|  | 1840 Height: 44.5 in  Net Weight: 28.8 lb.  1 x LED STRIP 76W 48V IP20 Multi-volt Dimmer Dry Location   50-60Hz |
|  | 1845 Height: 76 in  Net Weight: 30.6 lb.  1 x LED STRIP 76W 48V IP20 Multi-volt Dimmer Dry Location   50-60Hz |
|  | 1855 Height: 44 in  Net Weight: 13.4 lb.  1 x LED STRIP 33W 48V IP20 Multi-volt Dimmer Dry Location   50-60Hz |
|  | 1860 Height: 76 in  Net Weight: 14.3 lb.  1 x LED STRIP 33W 48V IP20 Multi-volt Dimmer Dry Location   50-60Hz |
|  | 1865 Height: 43.3 in  Net Weight: 19.4 lb.  1 x LED STRIP 50W 48V IP20 Multi-volt Dimmer Dry Location   50-60Hz |
|  | 1870 Height: 75.2 in  Net Weight: 20.7 lb.  1 x LED STRIP 50W 48V IP20 Multi-volt Dimmer Dry Location   50-60Hz |
|  | 1875 Height: 42.2 in  Net Weight: 26.2 lb.  1 x LED STRIP 76W 48V IP20 Multi-volt Dimmer Dry Location   50-60Hz |
|  | 1880 Height: 74.8 in  Net Weight: 28.2 lb.  1 x LED STRIP 76W 48V IP20 Multi-volt Dimmer Dry Location   50-60Hz |

Dry Location

This lamp is for indoor use only, excluding bathrooms or any type of damp surface.

Cette lampe est exclusivement destinée à une utilisation en intérieur, à l'exclusion des salles de bain et de tout type de surface humide.

IP20

Product protected against solid object as big as or bigger than 1/2". No protection against water.

Produit protégé contre les intrusions de corps solides de taille égale ou supérieure à 1/2". Non protégé contre l'eau.

Multi-volt

Voltage range
Gamme de tension
100-277V



Alternating current
Courant alternatif
50/60Hz



Step 2/6

Supplied Materials

Supplied material / Matériel fourni

| | |
|--|-------|
| 1. Canopy / Pavillon | 1 un. |
| 2. Components Bag / Sachet d'accessoires | 1 un. |
| 3. Lighting fixture / Structure du luminaire | 1 un. |
| 4. Template / Outil de marquage | 1 un. |

1

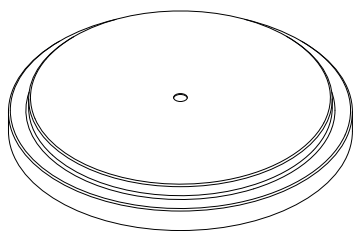

2

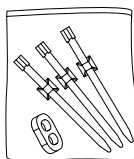

3

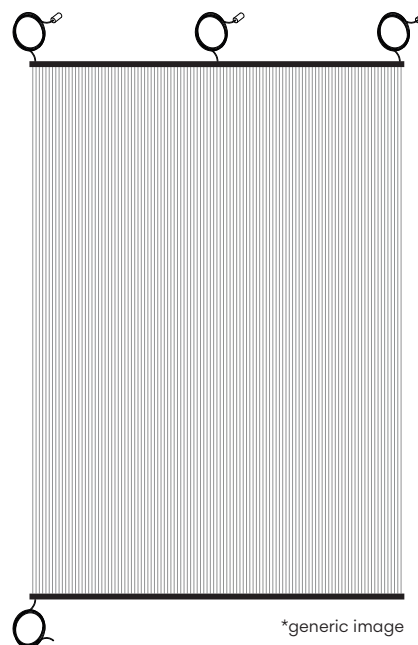

4

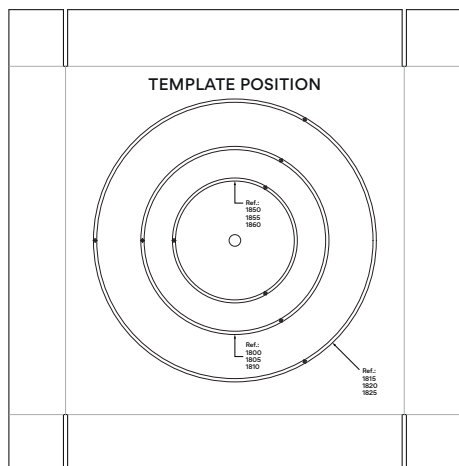

- Template necessary for the following models:
- Outil de marquage nécessaire uniquement pour les modèles suivants :

1820 1830 1840 1875
1825 1835 1845 1880



Step 3/6 Installation Preparation

3.1

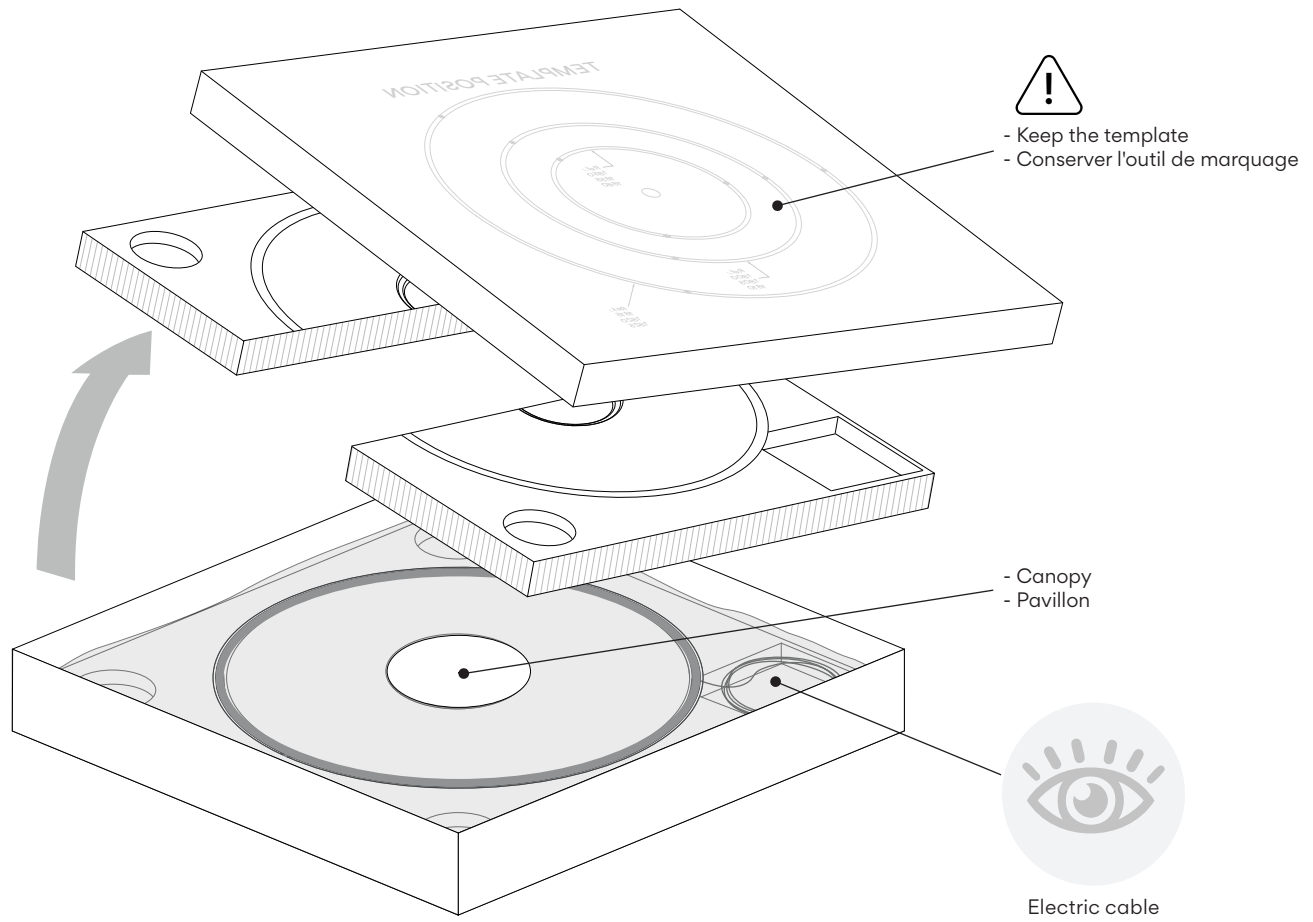

3.2

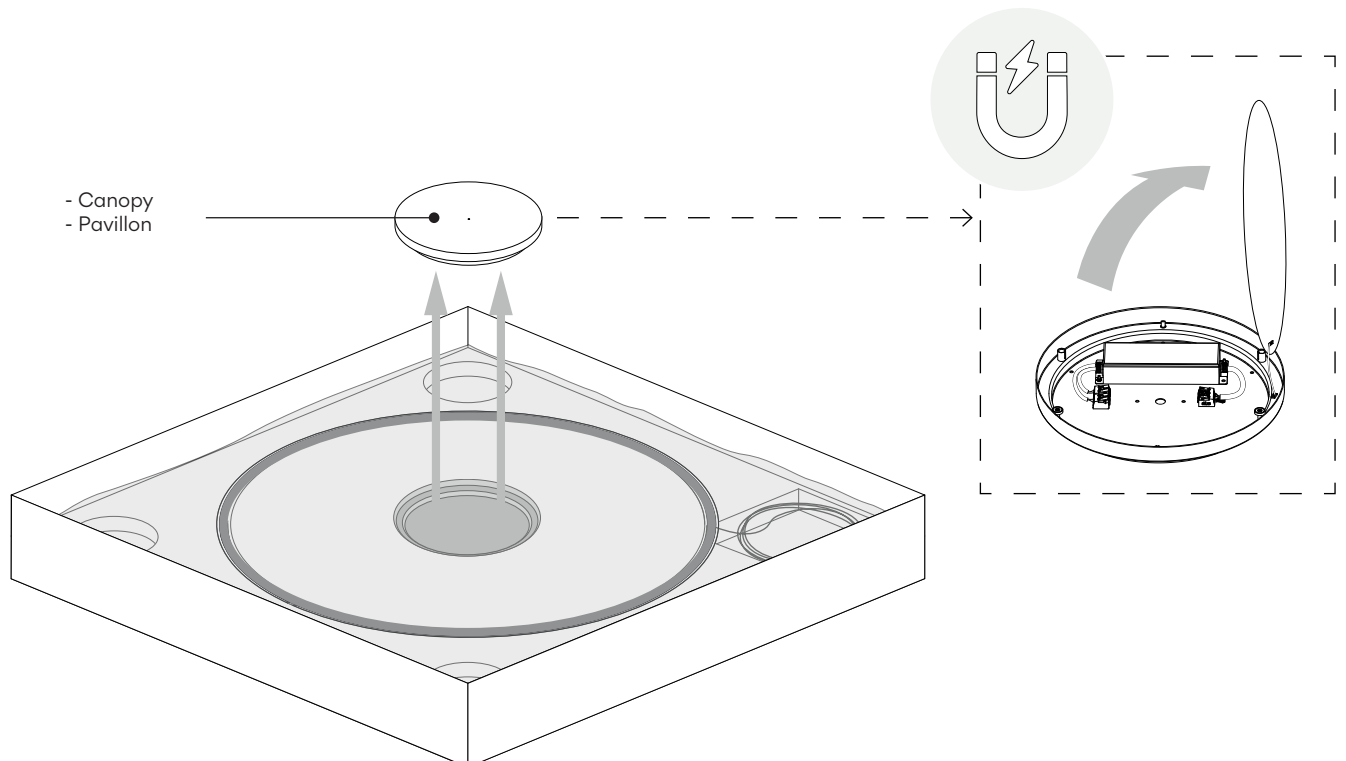



Step 3/6 Installation Preparation

3.3

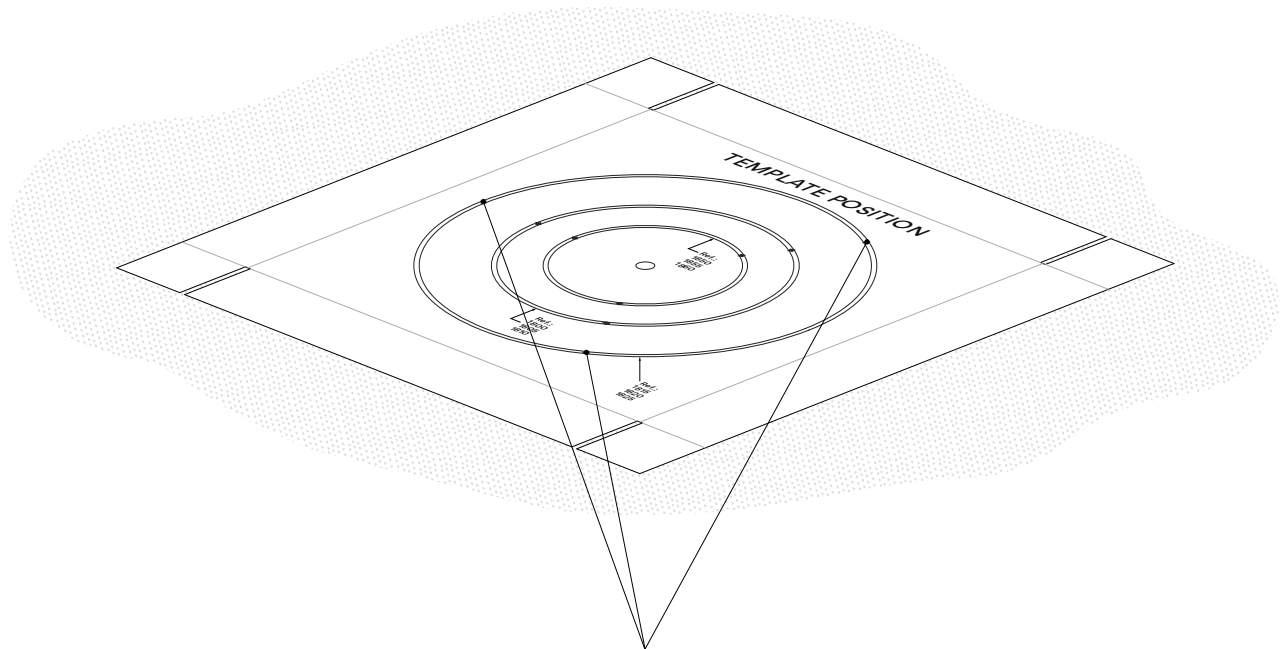

- Template only necessary for the following models:
- Outil de marquage nécessaire uniquement pour les modèles suivants :

| | | | |
|------|------|------|------|
| 1820 | 1830 | 1840 | 1875 |
| 1825 | 1835 | 1845 | 1880 |

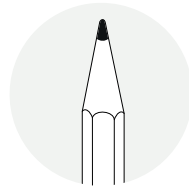

- Mark ceiling
- Marquer le plafond

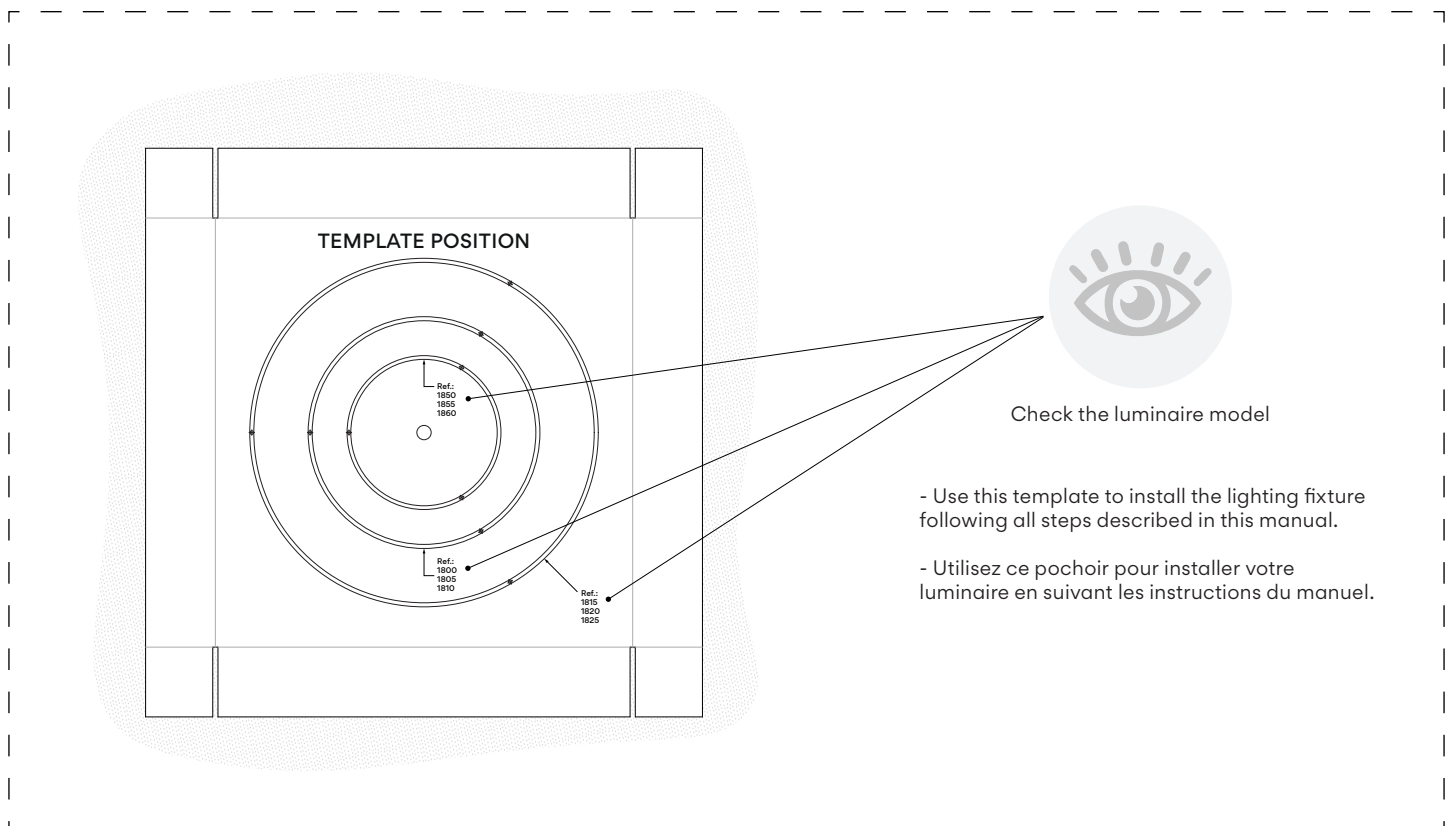

Check the luminaire model

- Use this template to install the lighting fixture following all steps described in this manual.
- Utilisez ce pochoir pour installer votre luminaire en suivant les instructions du manuel.



Step 4/6 Electrical Connection

4.1

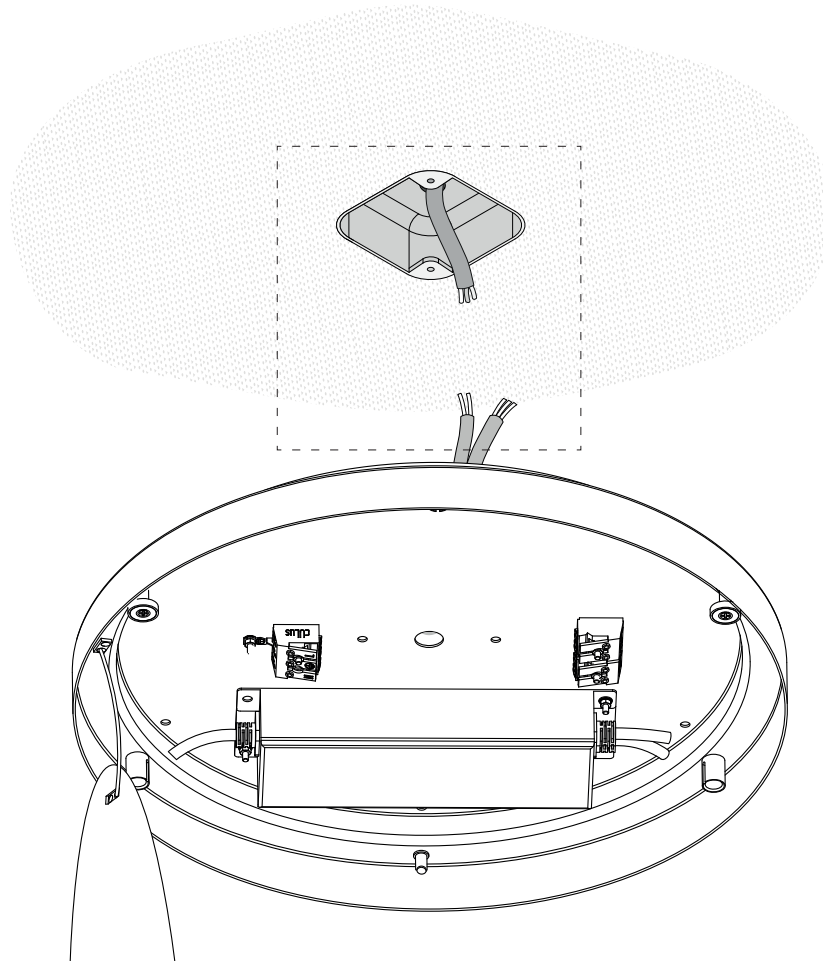

0-10V DIMMING SYSTEM

Refs.:
18XXXX/12_10

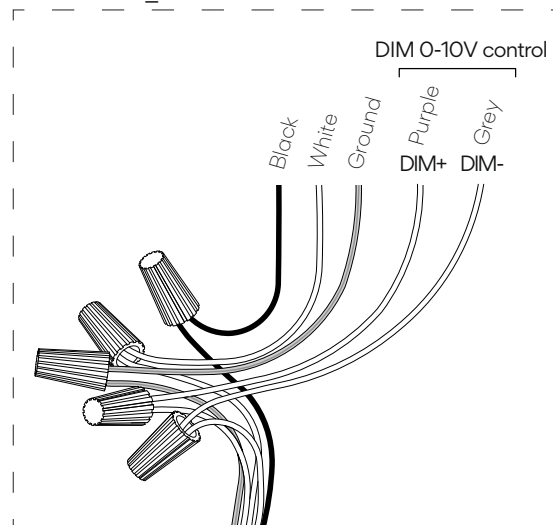

- VERY IMPORTANT: Make sure that the power supply to your installation is disconnected before making the connection.

- TRÈS IMPORTANT: Assurez-vous que le courant électrique de votre installation est coupé avant de connecter.

- Only for product references ending in 2_10
- Uniquement pour les produits terminés en 2_10



Step 5/6 Product Assembly

5.1

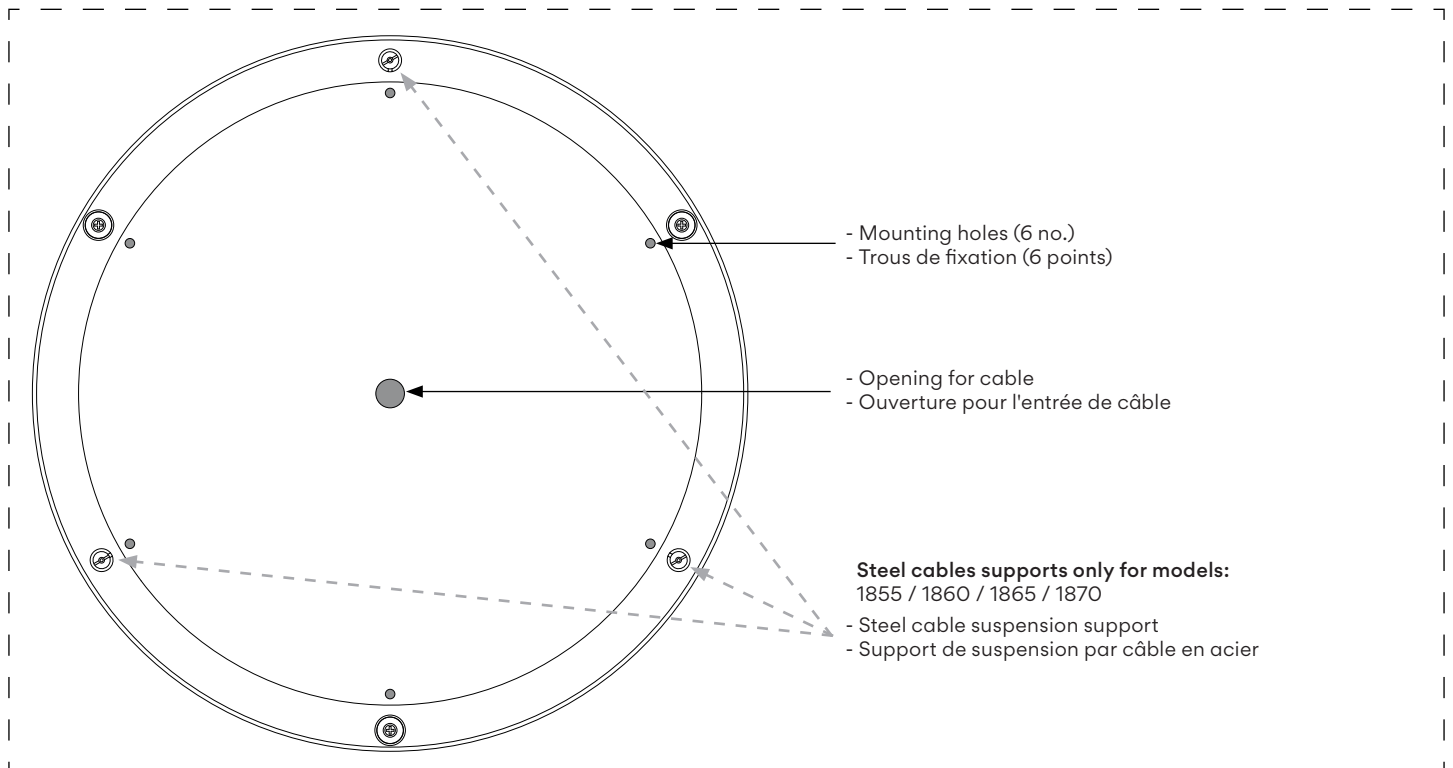
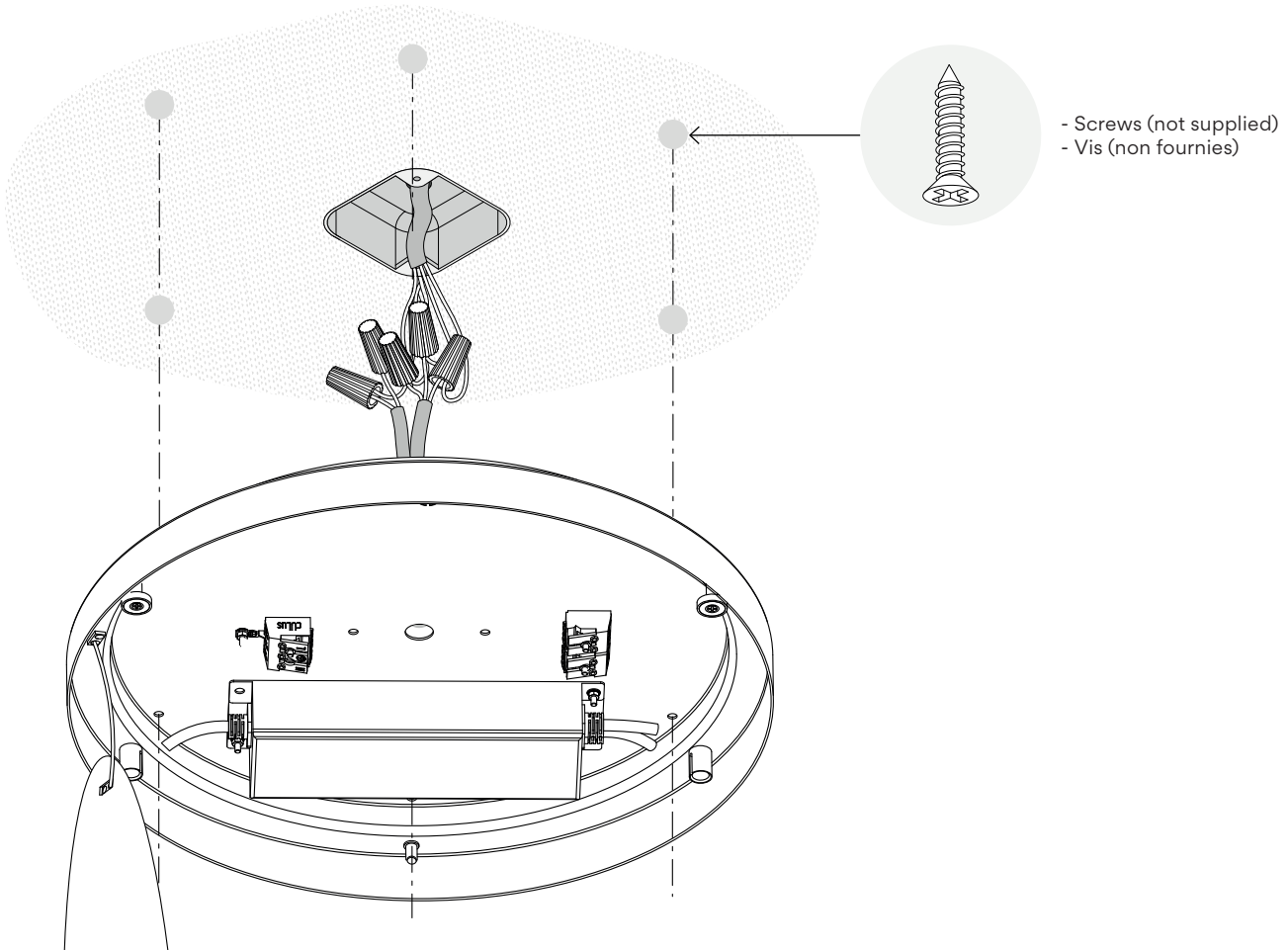



Step 5/6 Product Assembly

5.2

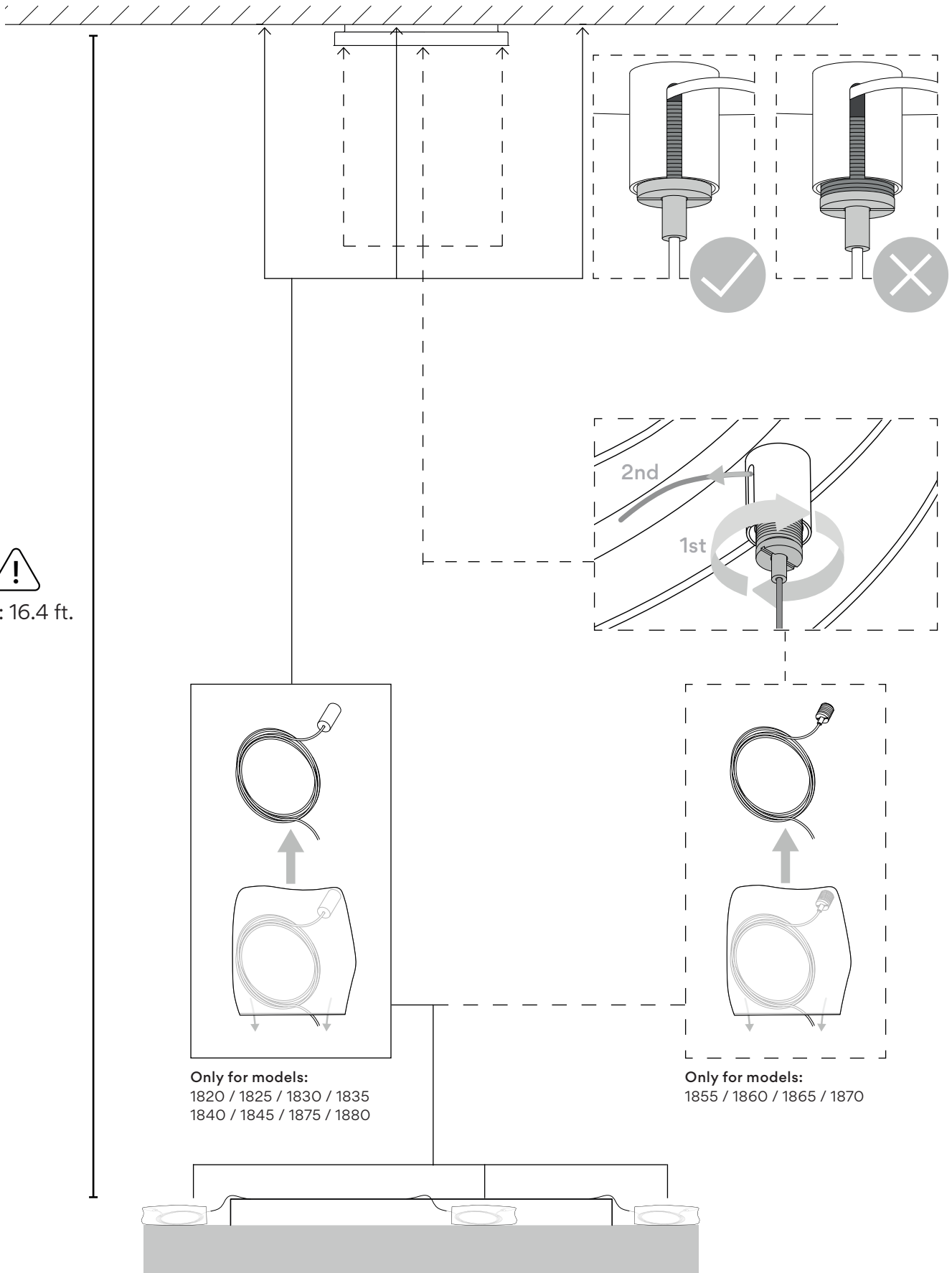

Max.: 16.4 ft.



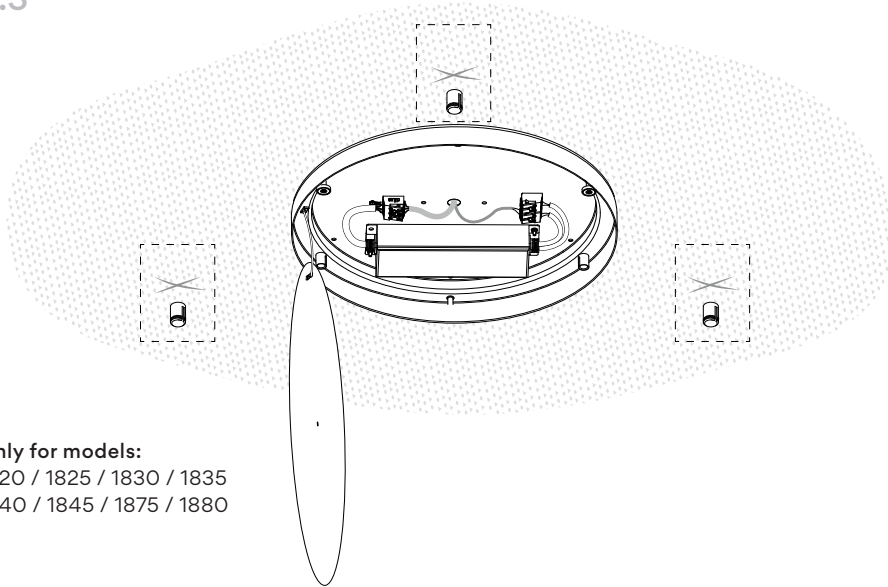

Step 5/6 Product Assembly

5.3



Only for models:
1820 / 1825 / 1830 / 1835
1840 / 1845 / 1875 / 1880

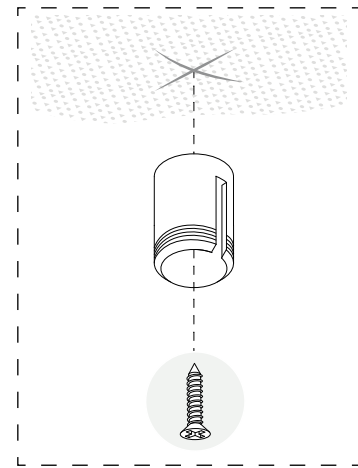

- Screws (not supplied)
- Vis (non fournies)

5.4

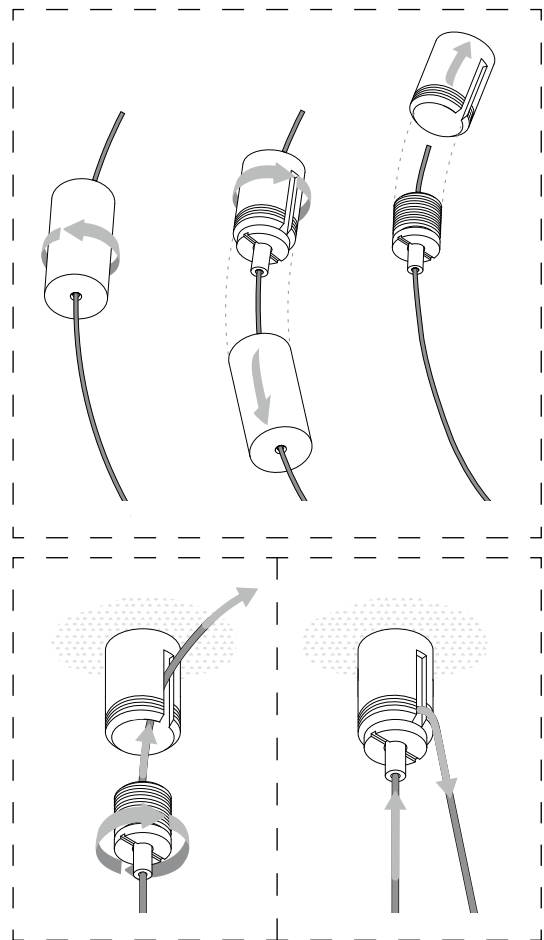

 Steel cable length = 32.8 ft.



Step 5/6 Product Assembly

5.5

Only for models:

1820 / 1825 / 1830 / 1835
1840 / 1845 / 1875 / 1880

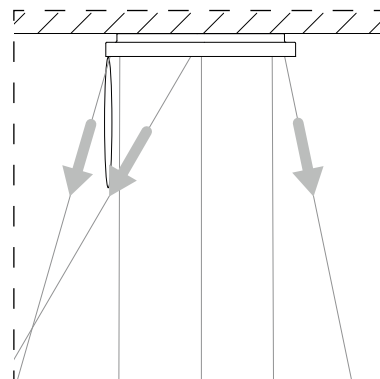
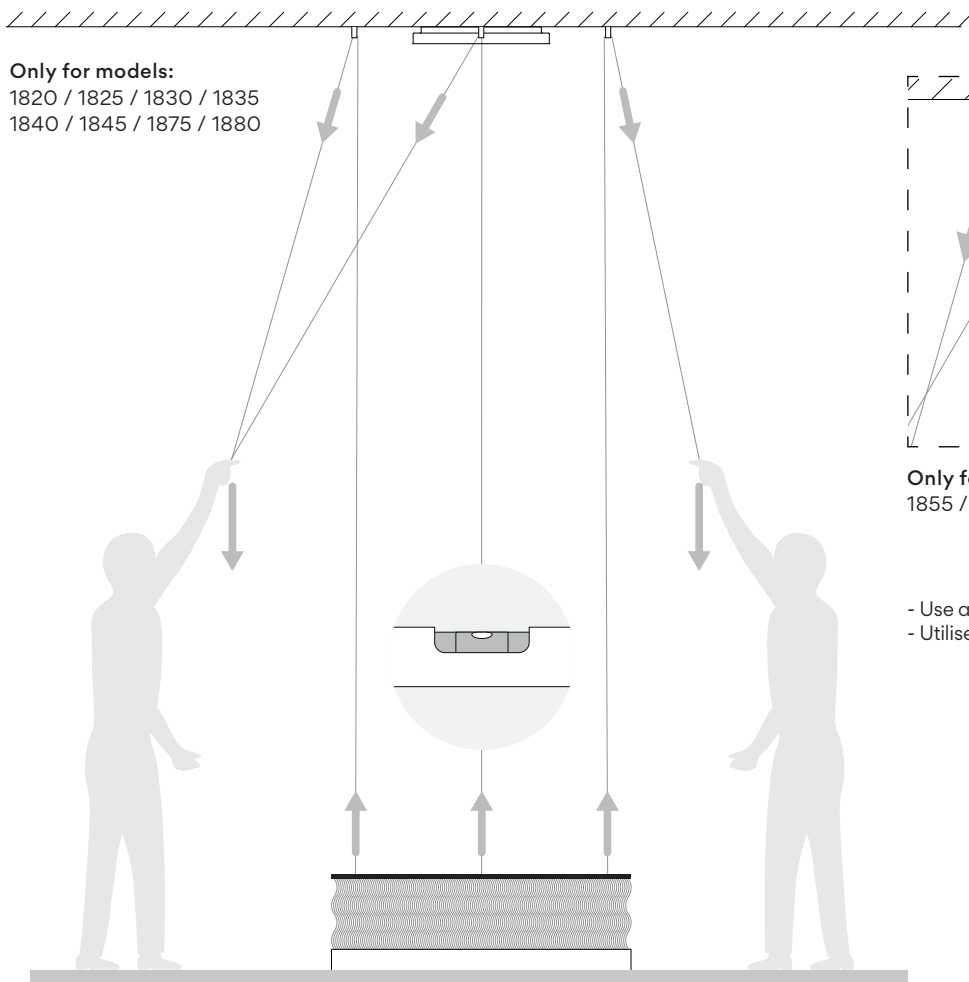

Only for models:

1855 / 1860 / 1865 / 1870

- Use a level tool (not supplied)
- Utiliser un niveau à bulle (non fournies)

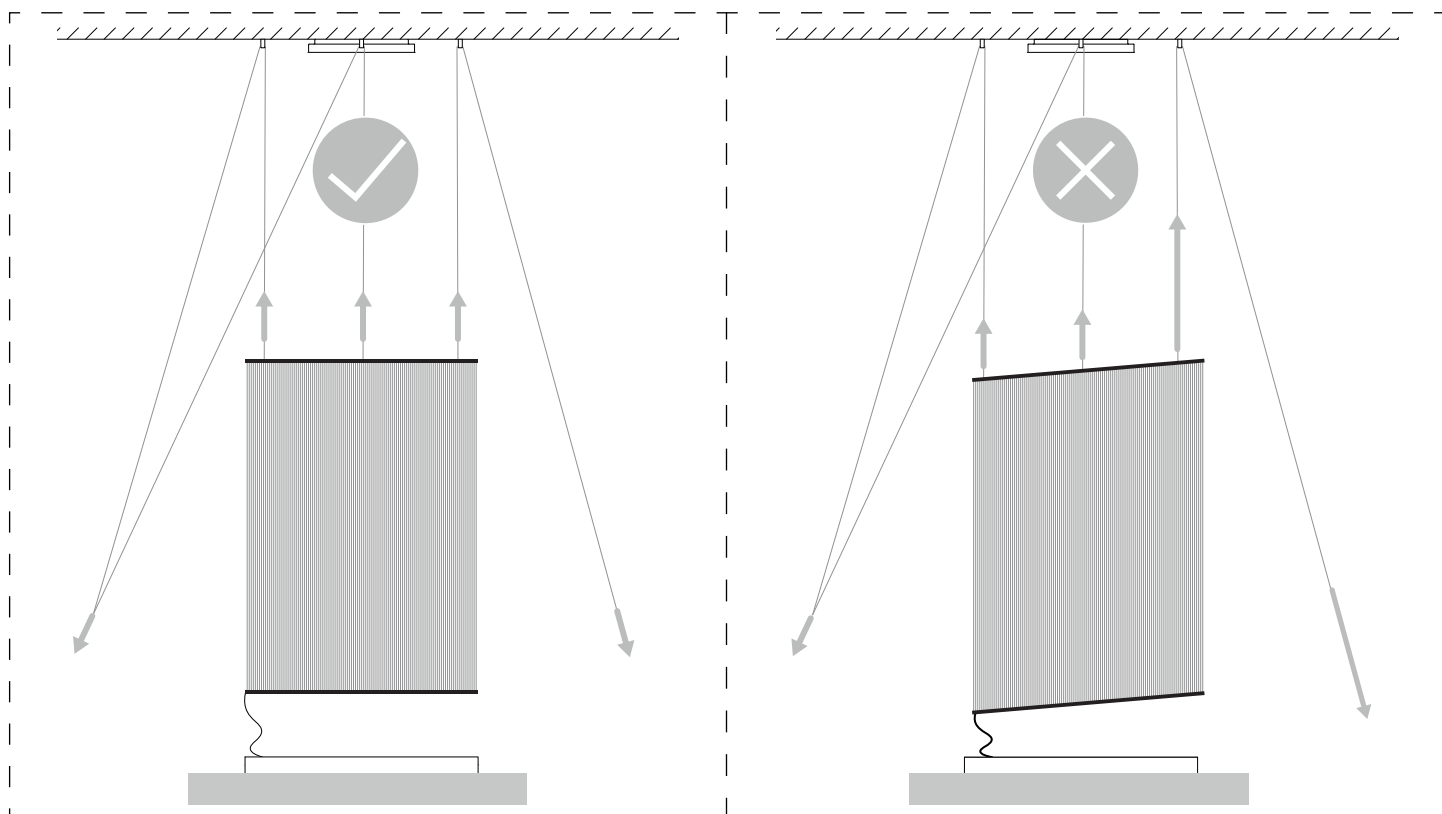



Step 5/6 Product Assembly

5.6

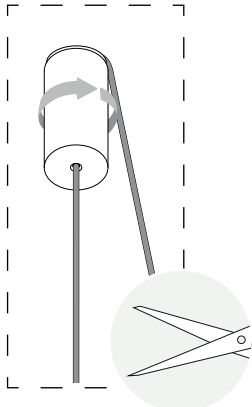
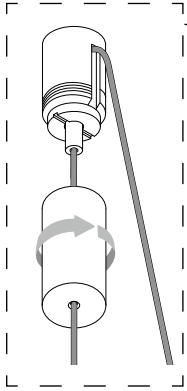
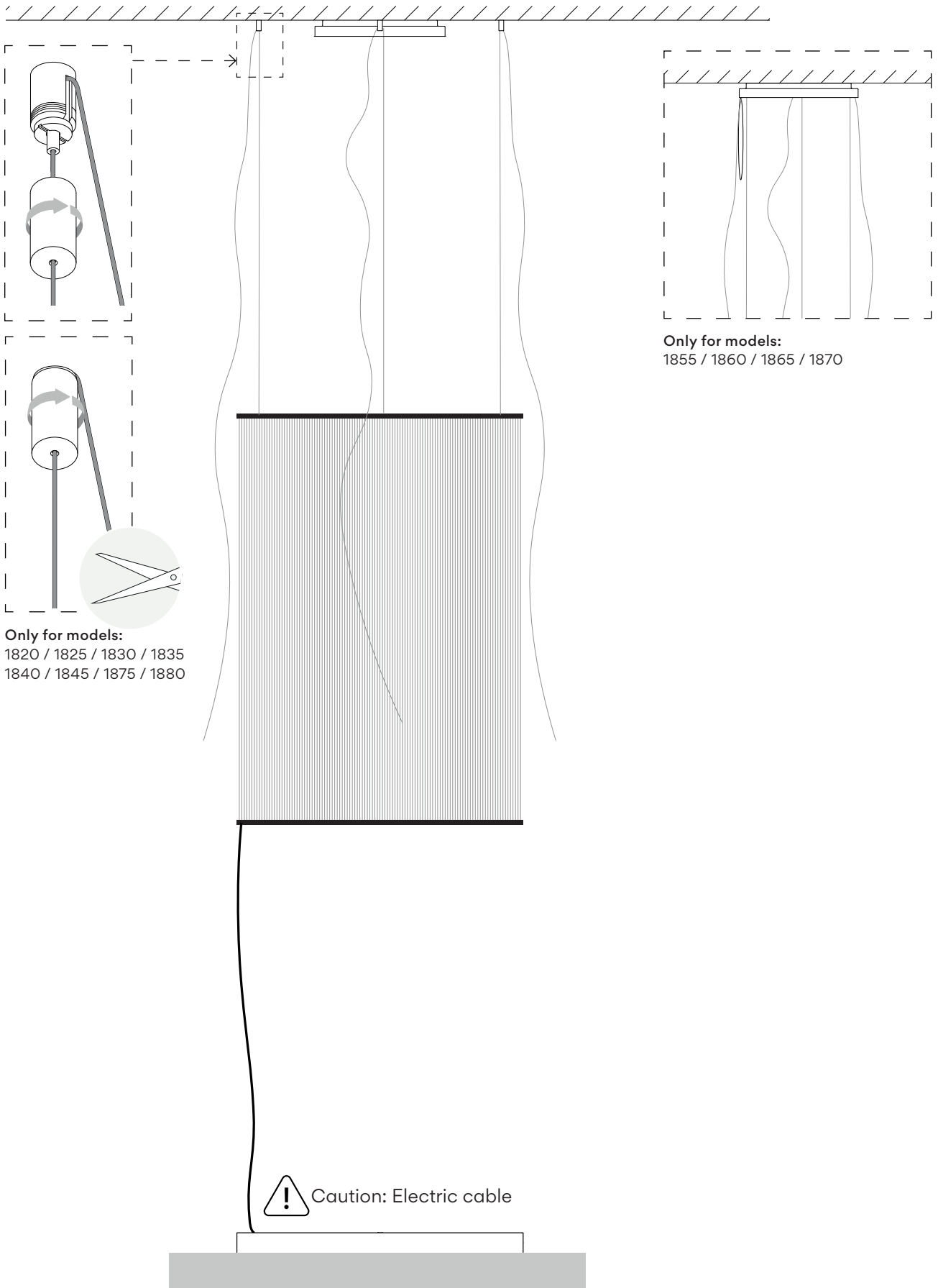

Only for models:
1820 / 1825 / 1830 / 1835
1840 / 1845 / 1875 / 1880

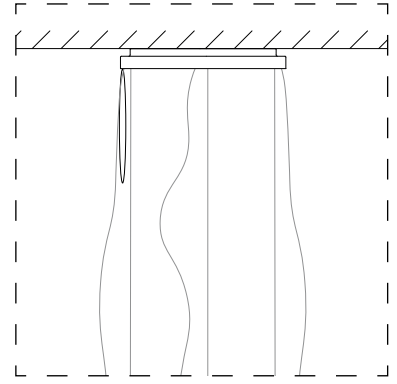

Only for models:
1855 / 1860 / 1865 / 1870

 Caution: Electric cable



Step 5/6
Product Assembly

5.7

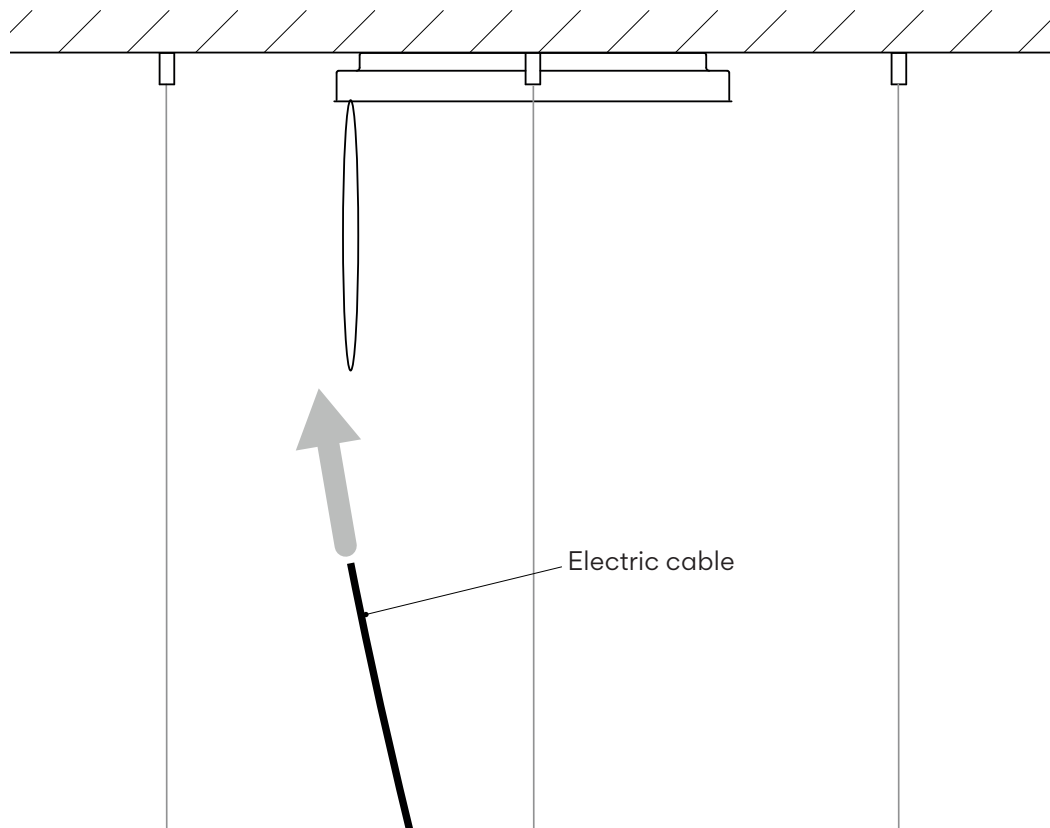

5.8

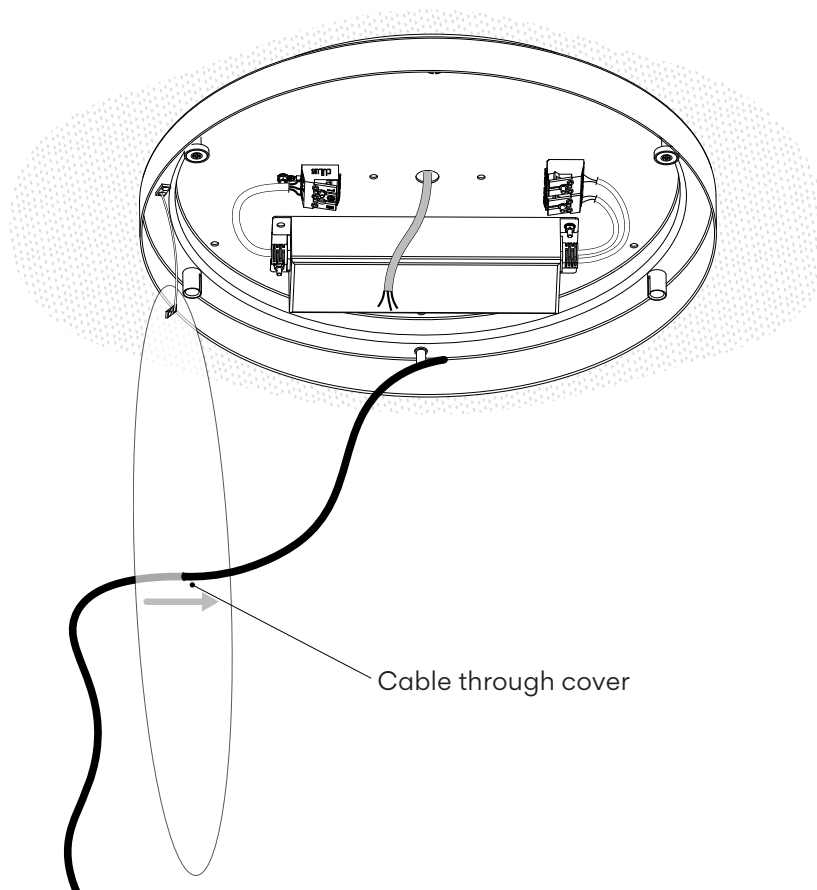



Step 5/6 Product Assembly

5.9

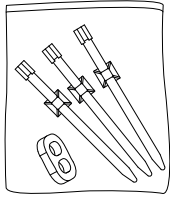

- Components Bag
- Sachet d'accessoires

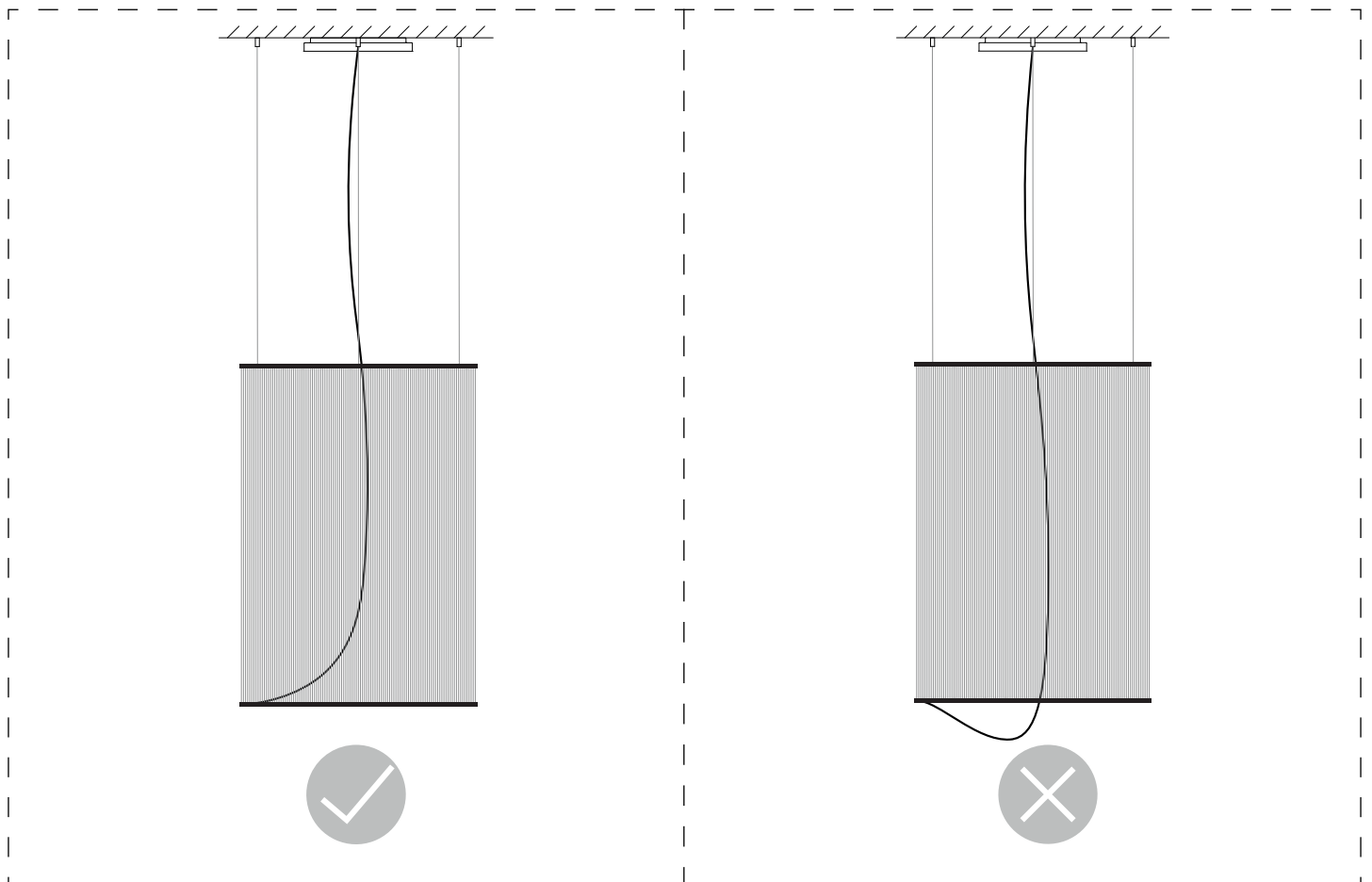
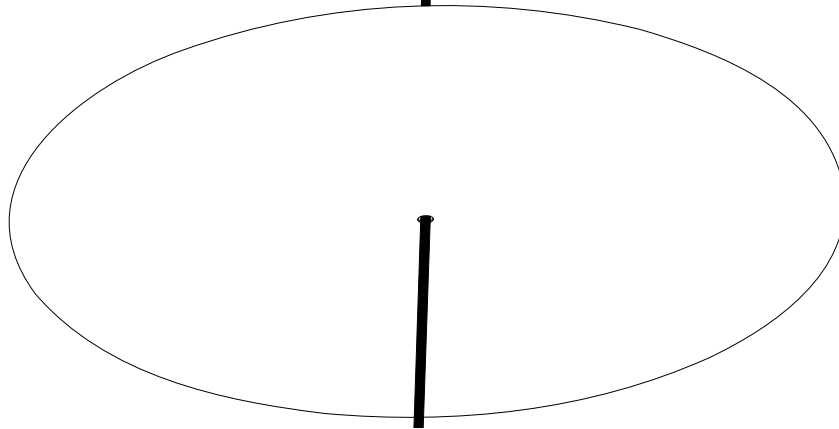
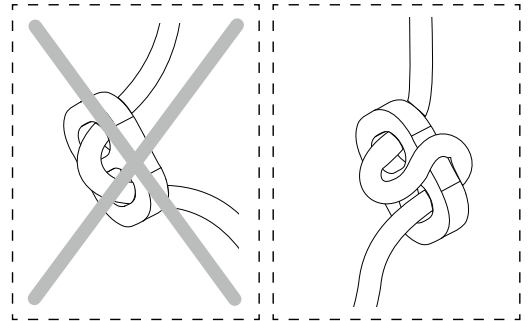



Step 5/6 Product Assembly

5.10

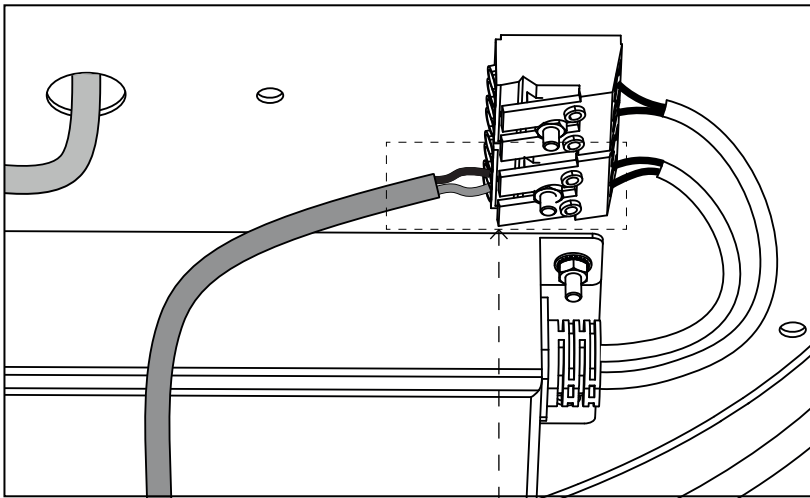

- VERY IMPORTANT: Make sure that the power supply to your installation is disconnected before making the connection.

- TRÈS IMPORTANT: Assurez-vous que le courant électrique de votre installation est coupé avant de connecter.

 CAUTION POLARITY

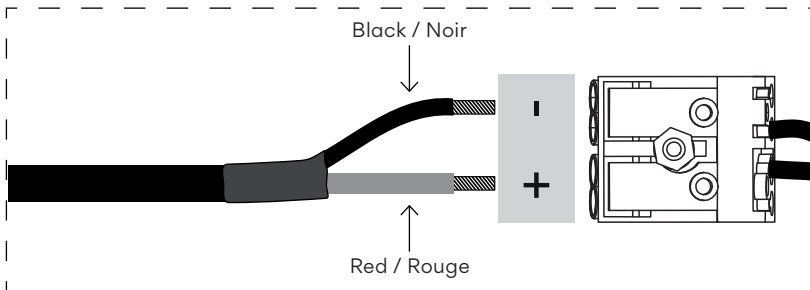

5.10

Closing the canopy

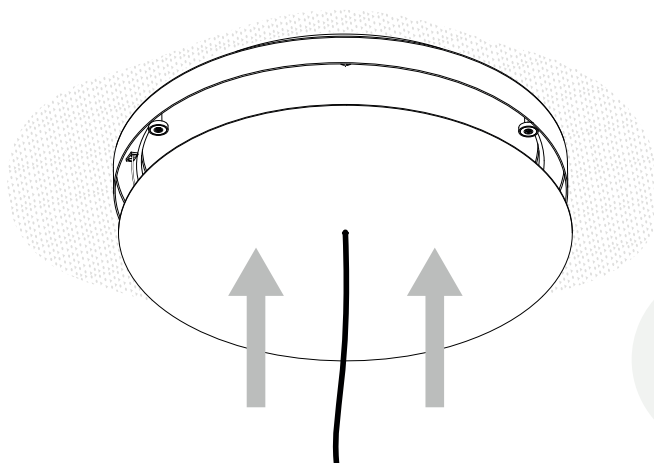

For models:
1820 / 1825 / 1830 / 1835
1840 / 1845 / 1875 / 1880

Closing the canopy

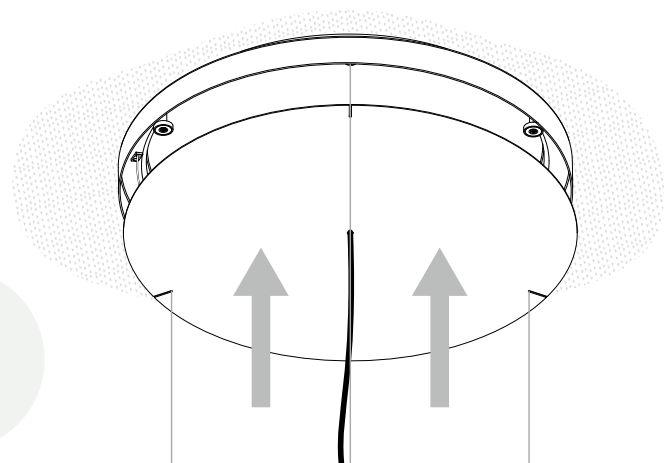

For models:
1855 / 1860 / 1865 / 1870

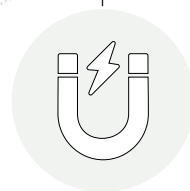



Step 6/6

Adjustments & Maintenance

Modify the height of the light / Régler la hauteur du luminaire

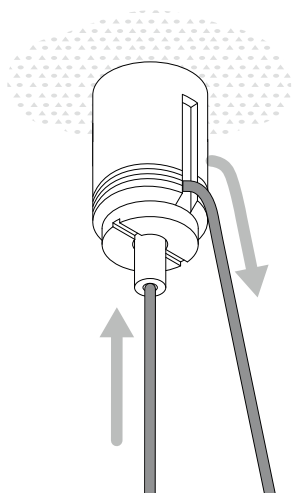

For models:
1820 / 1825 / 1830 / 1835
1840 / 1845 / 1875 / 1880

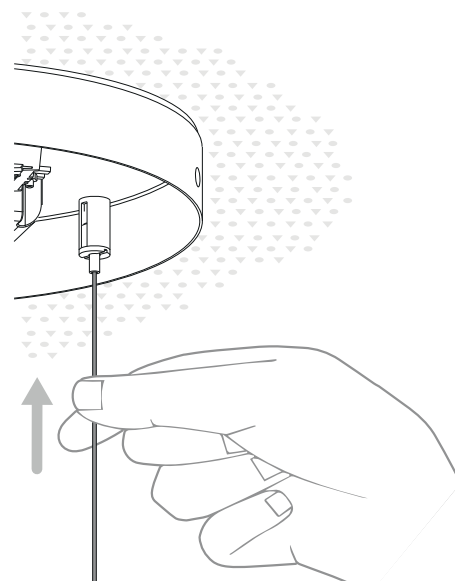
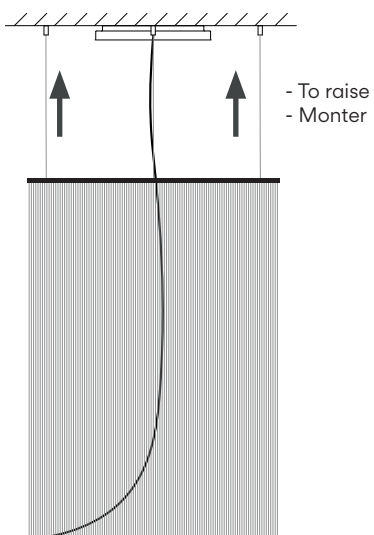

For models:
1855 / 1860 / 1865 / 1870

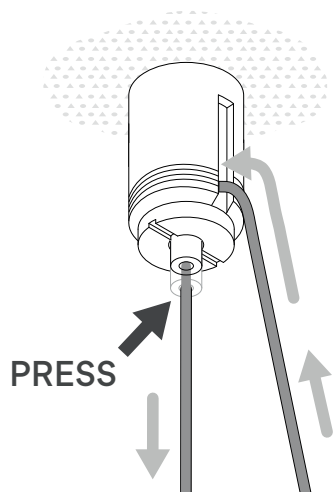

For models:
1820 / 1825 / 1830 / 1835
1840 / 1845 / 1875 / 1880

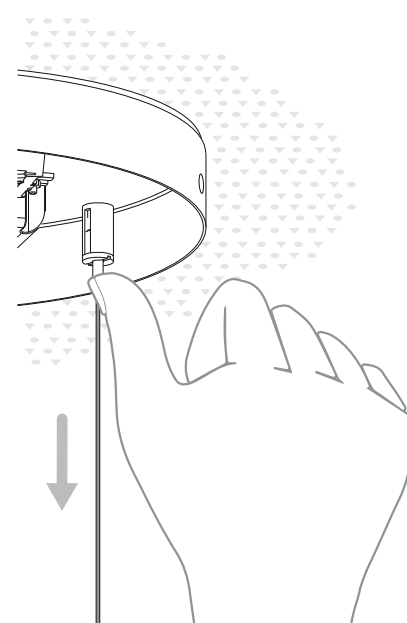
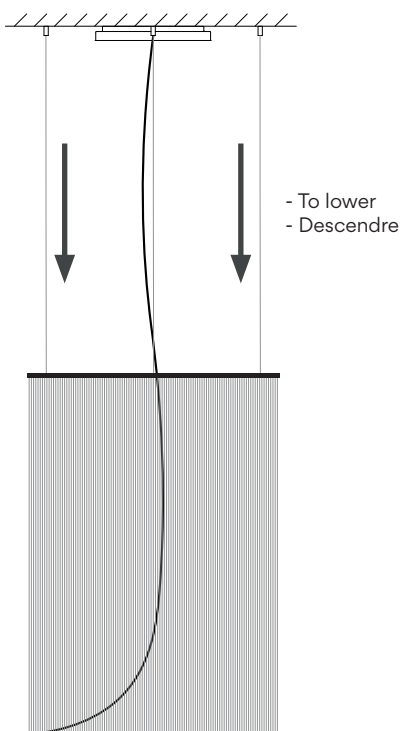

For models:
1855 / 1860 / 1865 / 1870



Step 6/6

Adjustments & Maintenance

Modify the cable length / Modifier la longueur du câble

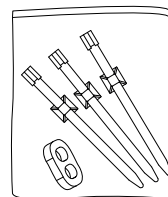
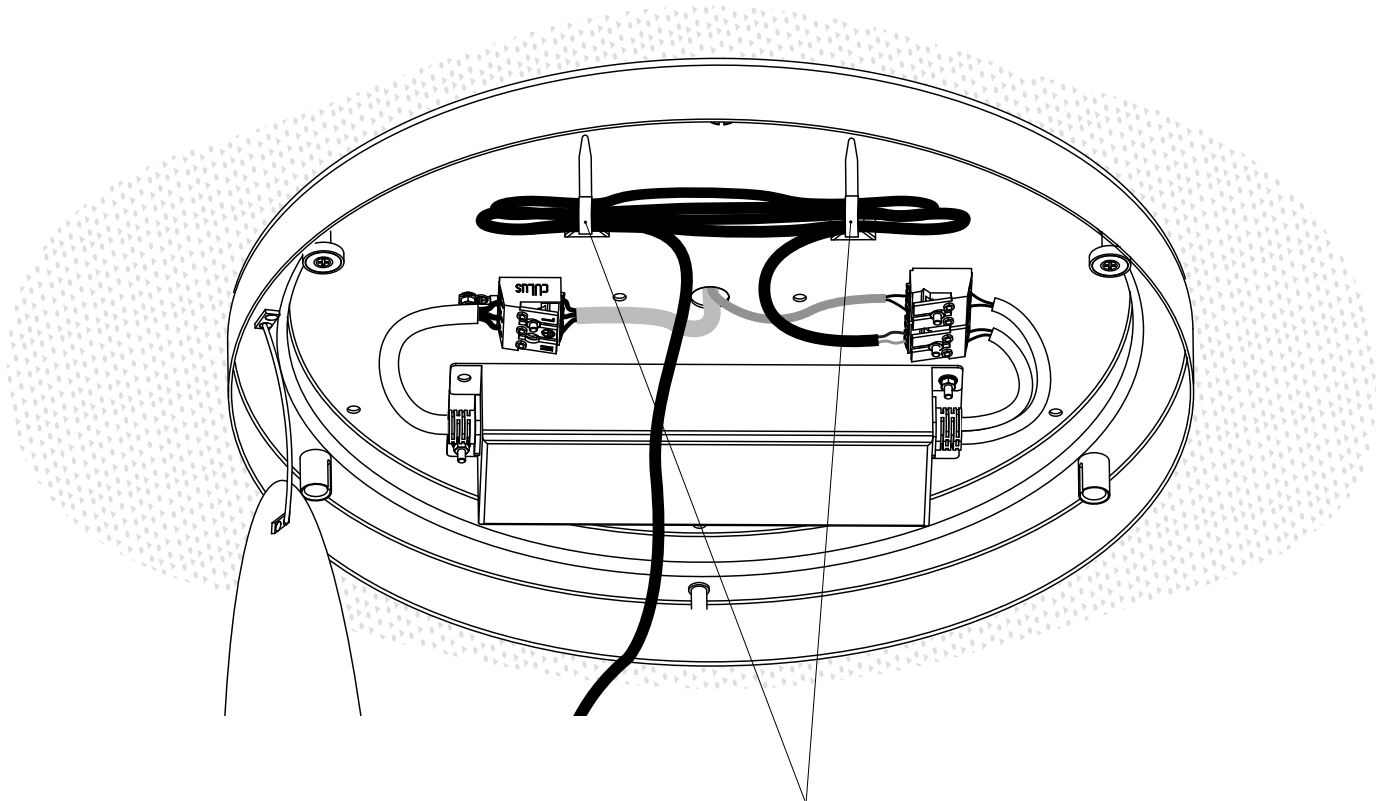

- Components Bag
- Sachet d'accessoires

Maintenance

Use a damp cotton cloth for cleaning.

In case of malfunction or damage, please contact the distributor who sold the lamp.

Entretien

Pour nettoyer le luminaire, utilisez un chiffon en coton légèrement humidifié d'eau.

En cas d'incident ou de non fonctionnement du luminaire, contactez directement l'établissement où vous l'avez acheté.

VIBIA. INC.

272 Fernwood Ave.
Edison, NJ 08837 . USA
Phone 732 417 1700.
Fax 732 417 1701.
sales@vibialight.com
www.vibia.com

VIBIA