

Tiertime X5  
**USER MANUAL**  
3D PRINTING + AUTOMATION

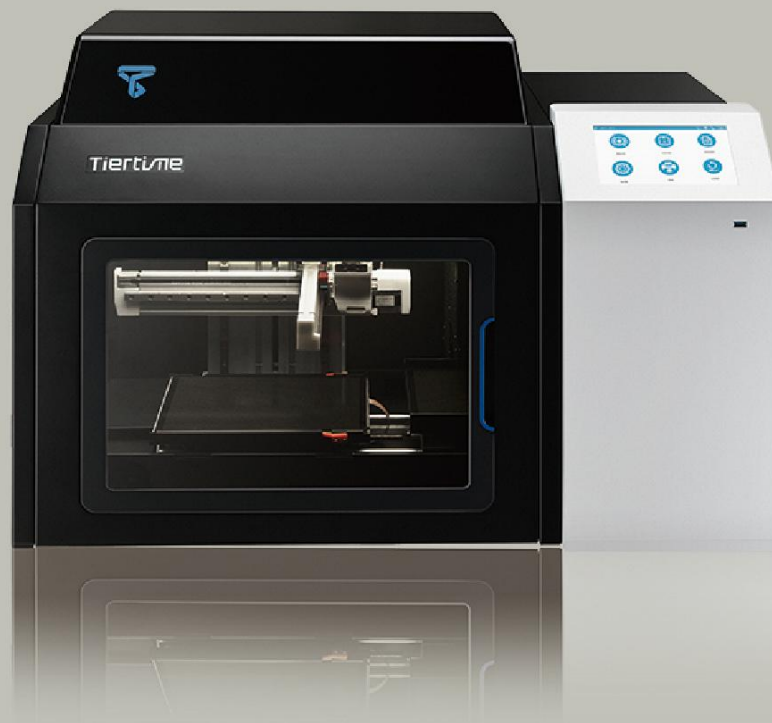

[www.tiertime.com](http://www.tiertime.com)

## **Chapter 1. Safety and Printing Environment**

### **1.1 Safety Precautions**

1. The X5 3D printer requires the power adapter provided by the original manufacturer, otherwise the machine could be damaged or even cause fire. Keep the power adapter away from water and out of high temperature environments.
2. During printing, the temperature of the nozzle of the printer could reach 260°C and the temperature of print platform could be over 70°C. Do not touch these parts with your bare hands when the printer is in the operation mode, not even with the heat resistant gloves included in the accessories, as the temperature could damage the gloves and injure your hands.

**WARNING, HOT SURFACES!**

**High Temperature: Do not touch!**

3. During printing, the print head and other mechanical parts move at high speed. Touching these parts while they are moving could cause injuries.

**Moving parts: Do not touch!**

4. Wear goggles when removing the supporting material from models or detaching models from the build plates.
5. When printing with plastic filaments, the process could generate slight and, for some people, annoying odor. It is recommended to run the printer in a well ventilated environment. We also suggest to keep the printer in an environment with a stable temperature as unwanted cooling could cause adverse effects to the print quality.
6. When using the “Extrude” function, make sure there is enough space between the print head nozzle and the build platform. 50mm is recommended, otherwise the nozzle could be blocked.

7. Fasten moving parts. Tie back loose hair, secure loose clothing and keep all printer doors closed during operation.

8. Do not leave the printer unattended during operation. Watch to make sure the first a few layers adhere correctly.

9. The left door is automatic, do not force it to open or hinder its operation.

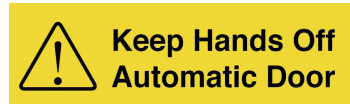

The top lid is not physically connected to the printer body, do not push the lid, should use both hand to lift the lid to avoid damage and injury.



## 1.2 Compliance



## Chapter 2. Machine Introduction

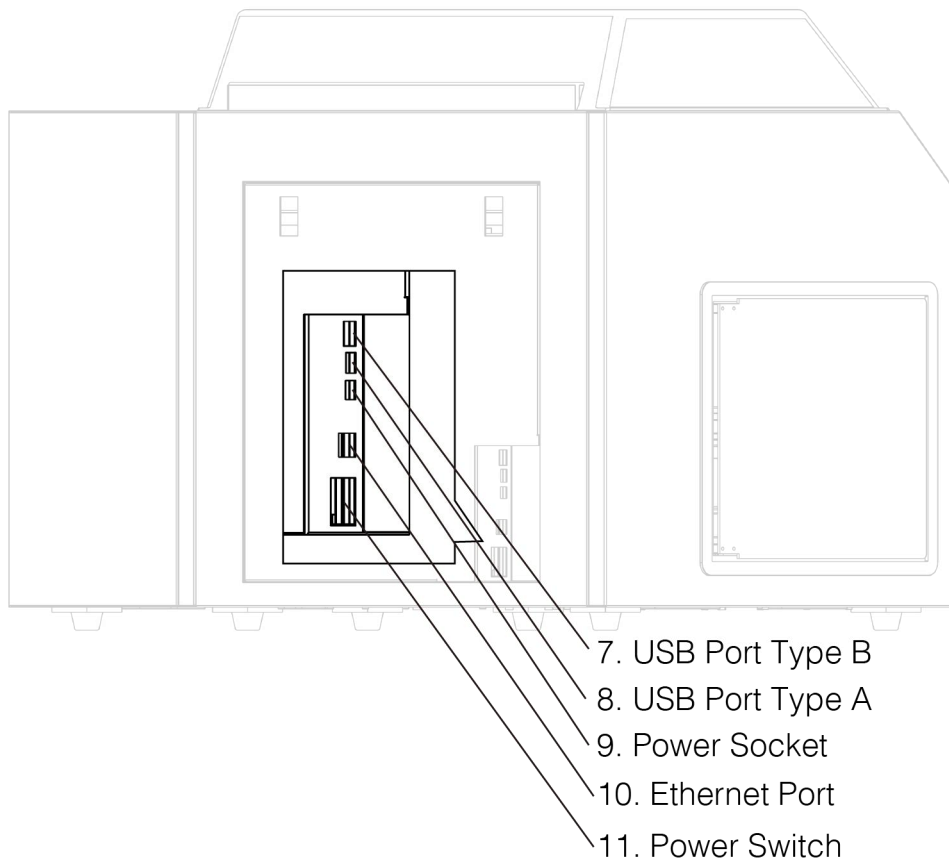
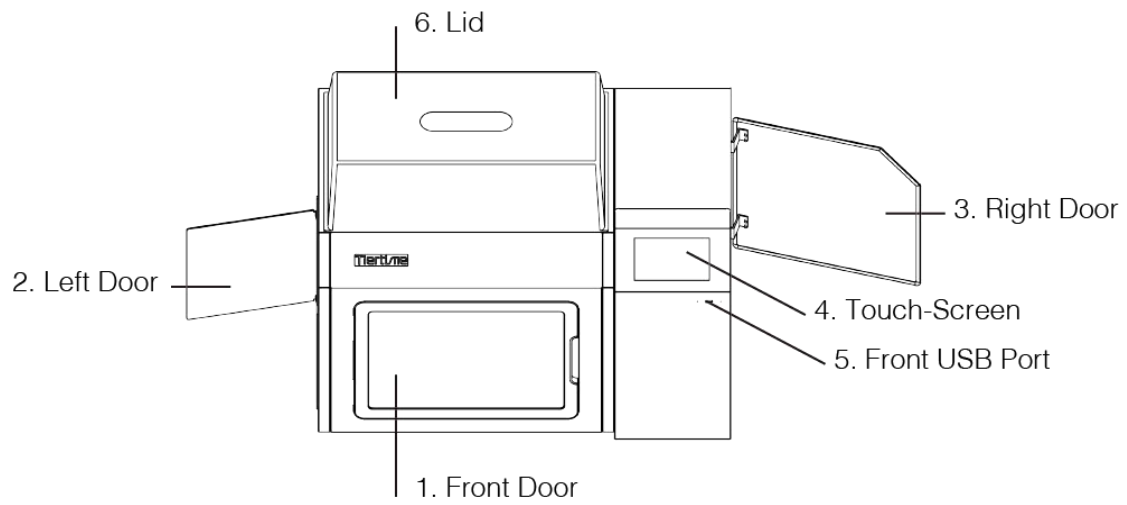

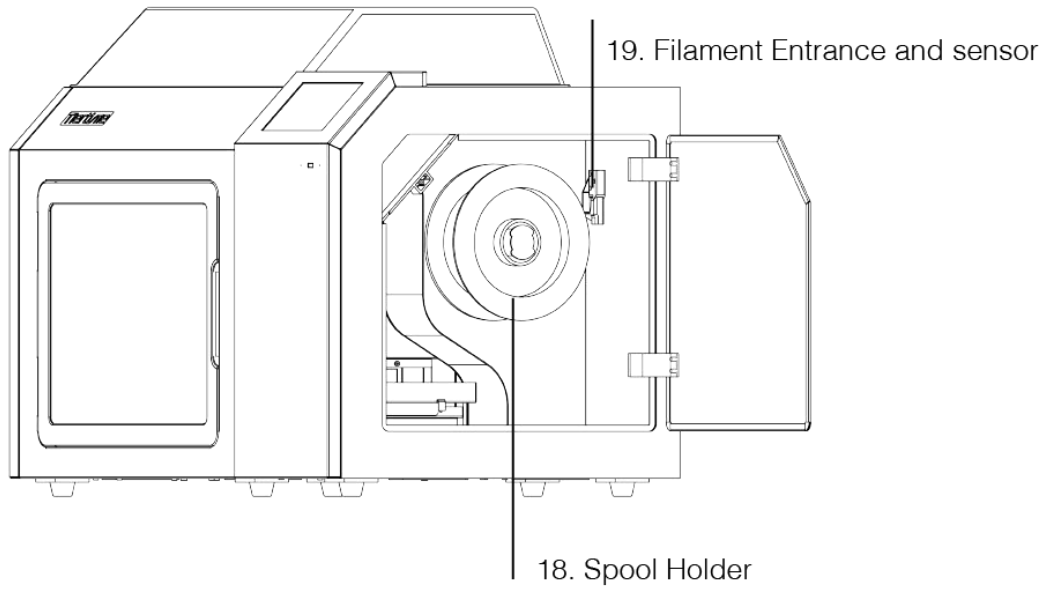
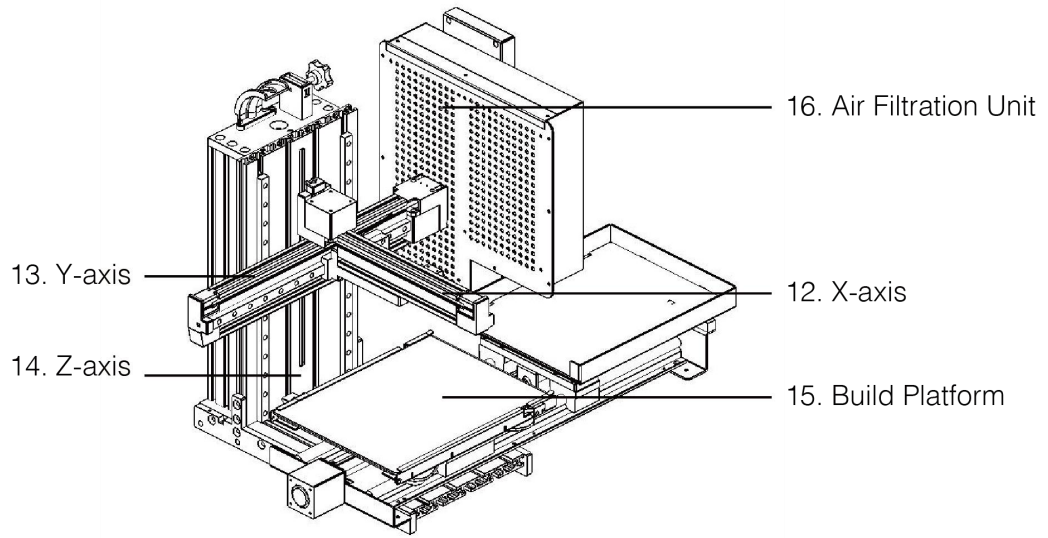

## Chapter 3. Download and install Software

3.1 To operate the X5, you need to install the UP Studio software version 2.5 or above on your computer. You can download the installation files of UP Studio software from the following URL:

[www.tiertime.com/download/software](http://www.tiertime.com/download/software) or search UP Studio in the App Store.

### System Requirements:

Support Operating Systems:

Windows 7 (SP1) or higher  
(32 bit and 64 bit)

Mac OS 10.10 or higher

Hardware requirements:

Open GL 2.0

At least 4GB of RAM

### Installation

Make sure you download the correct version of software based on your computer's configuration.



### 3.2 Updating the touchscreen firmware.

Go to <https://www.tiertime.com/downloads/>

Download the touchscreen firmware and copy the file into a usb disk. Please note the file name should not be changed and the file have to be in the root folder.

Switch off the machine and insert USB disk into the front USB port. Switch on the machine and the touchscreen will prompt message asking whether update to the touch screen firmware.



## Chapter 4. Connecting The Machine:

### 4.1 USB

Connect the machine to a computer through the USB type B port.



### 4.2 Ethernet

The machine and the computer must be connected with a router.





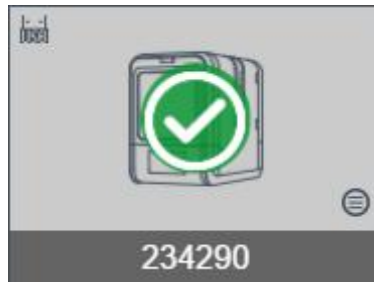

### 4.3 WIFI

Connect to the machine with a USB cable and then go to the printer setting. Setup the network SSID and Password.

Click the  button to setup the WIFI

A settings dialog box with a grey background and a close button (X) in the top right corner. It contains several fields and controls:

- Name :** A text field containing '234290' with a pencil icon to its right.
- WLAN :** A dropdown menu showing 'Not connected' with a downward arrow and an information icon (i) to its right.
- LAN :** A text field containing 'Not connected' with an information icon (i) to its right.
- Type :** A text field containing 'UP mini 2'.
- SN :** A text field containing '234290'.
- Version :** A text field containing '353'.
- SD Card :** A text field containing 'Reset to Default'.
- Private :** A toggle switch that is currently turned off.
- At the bottom right, there are two buttons: 'Confirm' and 'Cancel'.

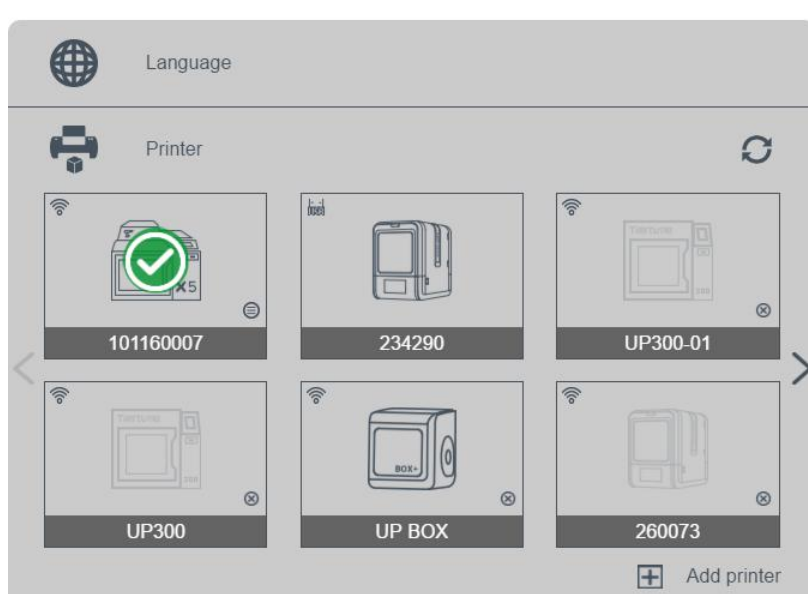

## Adding a Printer

Please note, for the Wi-Fi connection, a printer will be first added to the printer list before the software can recognize the printer. After adding the printer, software will actively scan for the presence of the machine and display it in the list of available machines appear in on upper left corner.

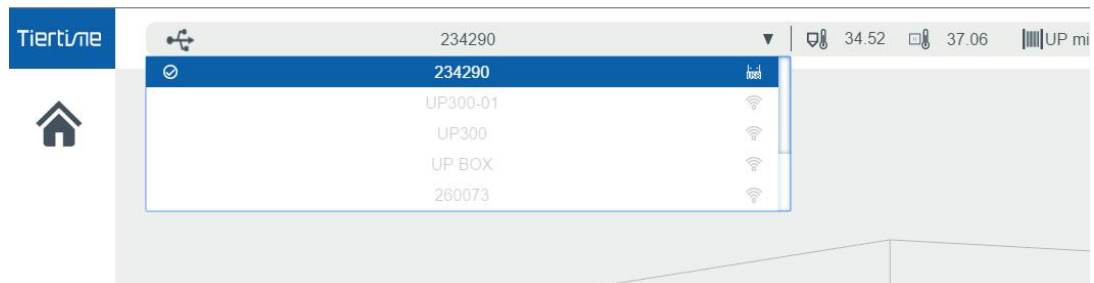

## Chapter 5. Printer Operation

### 5.1 Load filaments

Insert the filament from the filament entrance in the spool chamber on right side.

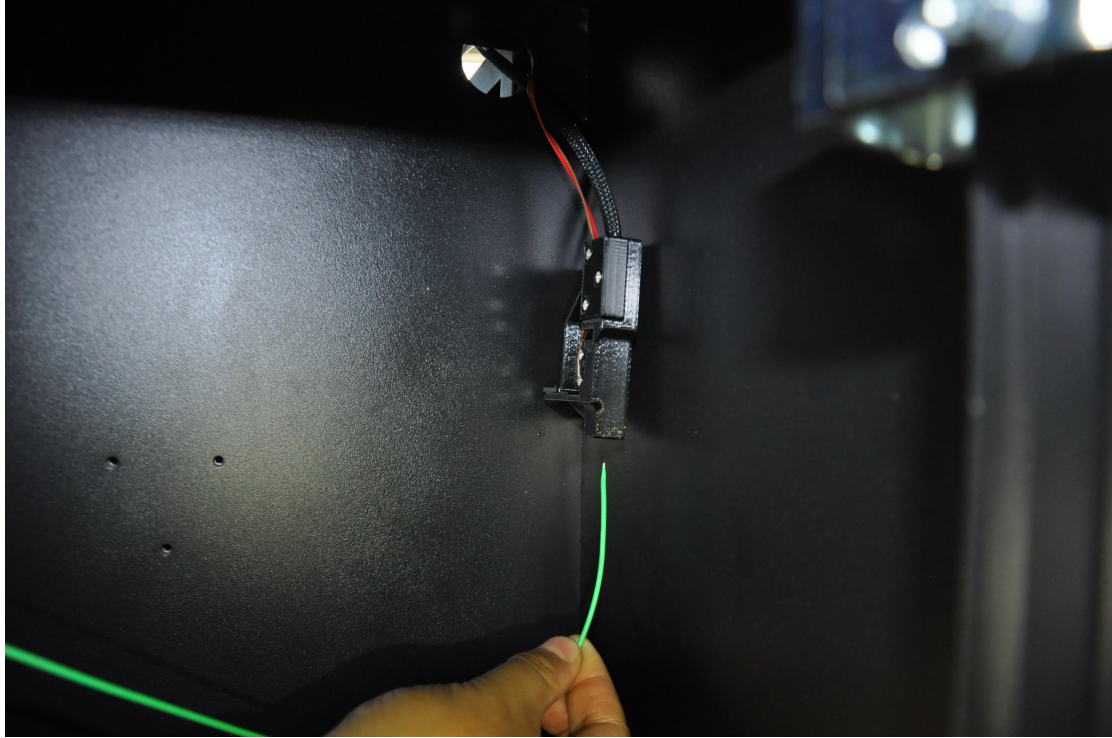

Go to the software, maintenance, select the material type, click the “extrude” button.

When the nozzle temperature reaches the target, the machine will buzz and start extruding. Gently push the filament into the extruder until the filament appears from the nozzle. The extrusion will continue for a while, and stop automatically.

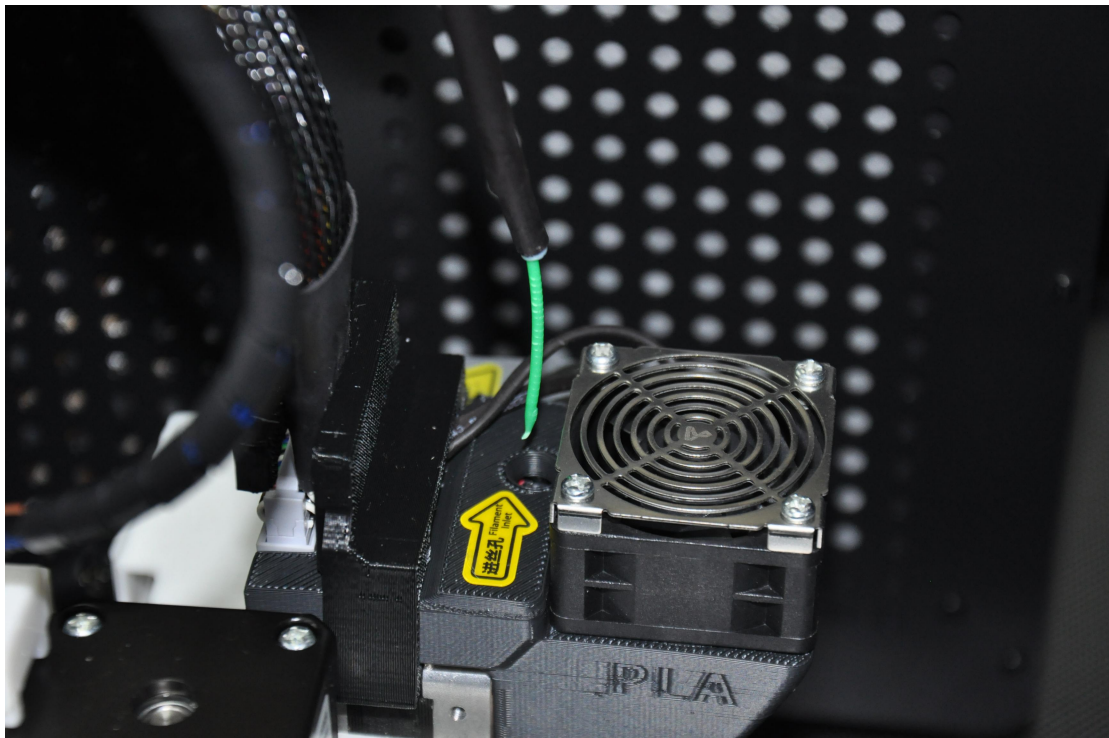
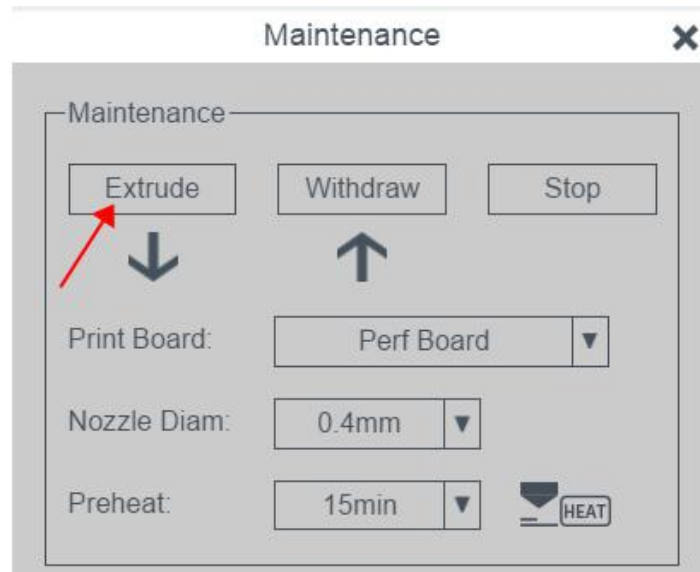

## 5.2 Overhead Spool rack

The overhead spool rack is designed for using flexible materials. To install the rack, insert the rack onto the socket inside the machine, put a spool of filament onto the rack, and insert the filament **without** using the filament guiding tube.



### 5.3 Load the Build Plates

The auto swapping platform can load up to 8 build plates. Due to the mechanism of swapping, the last build plate cannot be used for printing. You can load the build plates from the front door.



## 5.4 Printing

Switching on the continuous mode by going to the Maintenance dialog. If the continuous mode is not checked, the printing will stop after finishing the current print job.

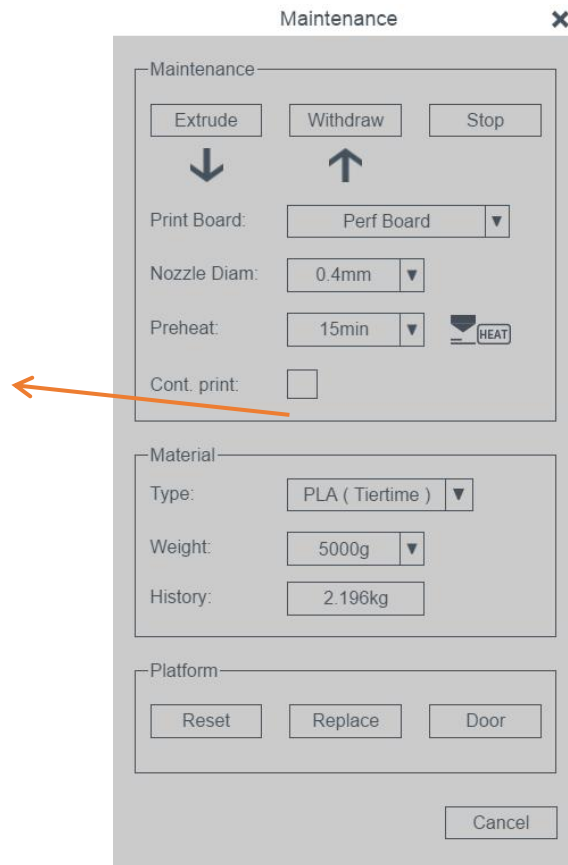

**Load a model into software**



Use the + button to load models into software.

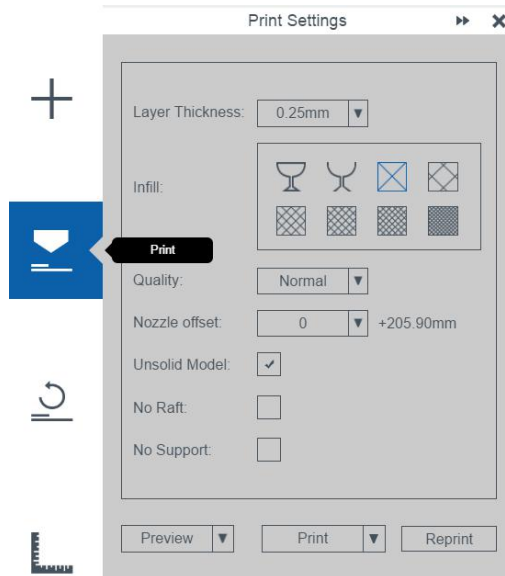

## 5.5 Tiertime Print Queue Explained

### The Current Print List (CPL)

Current list		History list					
Print order	Name	Status	Task publisher	Upload time	Total print time	Operation	
1	cube	Failed	Administrator	2018-09-26 11:43:22	3h28m	⏪ ⏩ ⏸ ⏹	
2	star	Waiting	unknown	---	3m	⏪ ⏩ ⏸ ⏹	
3	cube	Failed	user	2018-09-27 17:18:34	4m	⏪ ⏩ ⏸ ⏹	
4	cube	Failed	user	2018-09-28 09:07:42	17m	⏪ ⏩ ⏸ ⏹	

Close



Moving queued print jobs up on the list



Start a Print Job



Stop a Print Job



Remove a Print Job from the CPL (The removed print job will be moved to the History Print List)

### Status

**Failed:** A print job failed due to an error or stopped by users

**Waiting:** A print job waiting to be printed. It will be printed according to the print order of the list.

### The History Print List (HPL)

Current list		History list						
Print order	Name	Status	Task publisher	Upload time	Total print time	Operation		
1	X5测试	Failed	Administrator	---	1m		<input type="checkbox"/>	
2	star	Failed	admin	---	3m		<input type="checkbox"/>	
3	平板	Failed	admin	---	8m		<input type="checkbox"/>	
4	平板	Failed	admin	---	12m		<input type="checkbox"/>	
5	Sphere	Failed	admin	---	20m		<input type="checkbox"/>	
6	Sphere	Failed	admin	---	20m		<input type="checkbox"/>	
7	star	Failed	admin	---	3m		<input type="checkbox"/>	
8	star	Failed	admin	---	1h23m		<input type="checkbox"/>	
9	star	Failed	admin	---	2h6m		<input type="checkbox"/>	
10	star	Failed	admin	---	2h6m		<input type="checkbox"/>	

[Clear history list](#)   [Repeat printing is selected](#)

The finished print jobs and all the print jobs removed from the CPL will go to the HPL.



Delete the print job completely

Operation Check Box: When checked, users can reactivate the print job and send it back to the CPL.

me	Total print time	Operation	
	1m		<input type="checkbox"/>
	3m		<input checked="" type="checkbox"/>
	8m		<input type="checkbox"/>
	12m		<input type="checkbox"/>
	20m		<input type="checkbox"/>
	20m		<input type="checkbox"/>
	3m		<input type="checkbox"/>
	1h23m		<input type="checkbox"/>
	2h6m		<input type="checkbox"/>
	2h6m		<input type="checkbox"/>

[Clear history list](#)   [Repeat printing is selected](#)

Repeat times:

 

Select a number of time to repeat this print job.



### 5.7 Setup the collection device:

It is recommended to setup a collection bucket or similar device to collect the finished prints. A soft basket is included in the package.

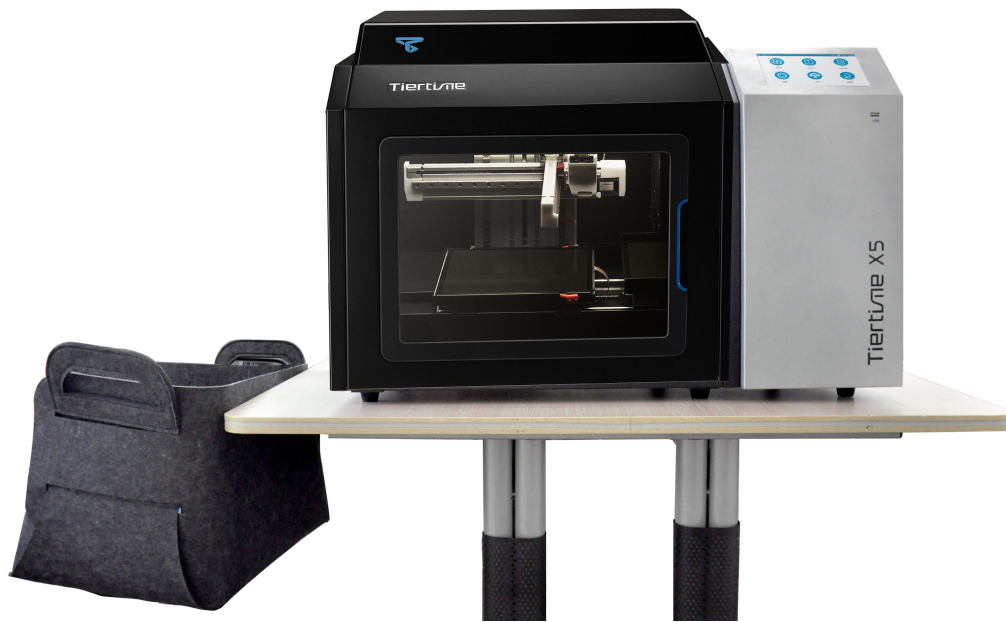

## Chapter 6. Machine Maintenance

### 6.1 Changing the Air Filters

To remove the air filters, unscrew the 3 screws on the filtration unit.

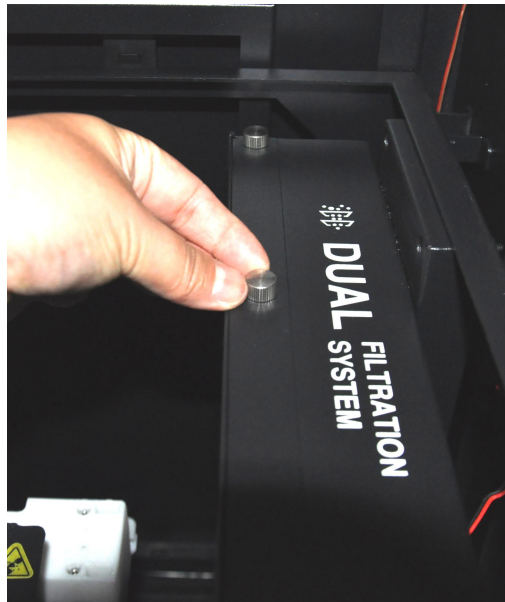

Remove the cover.



**Pull out the filter**



## Chapter 7.Touchscreen Instruction

TierTime X5 Touchscreen consists of two sections,the Printer Status Bar and the Main Menu.



X5 Touchscreen Display

### 7.1 Touchscreen Introductions

#### Printer Status Bar

The Printer Status Bar is at the top of the X5 Touchscreen, which is easier for you to monitor the printer's status regularly. There are five icons in the Printer Status Bar, each of which represents different aspects as explained in the following, starting from left to right:



Left

Printer Status Bar

Right

1. **Temperature Icon:** It has the thermometer icon, the nozzle temperature indicator, and the build plate temperature indicator.
2. **Ethernet Status Icon:** It indicates the Ethernet connection status.
3. **Wi-Fi Status Icon:** It shows the Wi-Fi network connection status. If there is a red exclamation mark on the top, it indicates that the Wi-Fi network has been detected but it is not connected to the printer. If there is no red exclamation mark on the top, it means that your printer has been connected to the Wi-Fi network successfully.
4. **Private Status Icon:** This lock icon indicates whether the printer has been set as private use to one particular user.
5. **Material Information Icon:** This icon represents the material's type name and the remaining weight of the current material roll. (It may appear

alternatively as Name/ Weight)

## Main Menu



There are eight buttons in the Main Menu: Material, Print, Maintenance, Calibrate, Information, Config, Network and Initialize.



### Main Menu

The following table lists all the information of icons in the Main Menu and summarizes the actions associated with each icon.

Main Menu Icon Description		
Name	Icon	Description
Material		<ol style="list-style-type: none"> <li>1. Change Material Type.</li> <li>2. Withdraw Material.</li> <li>3. Extrude Material.</li> <li>4. Set Material Weight.</li> </ol>
Print		<ol style="list-style-type: none"> <li>1. Print Job Current List</li> <li>2. Print Job History List (Print Task Management).</li> <li>3. USB Stick Print Job.</li> <li>4. Print Job's Details.</li> <li>5. Pause the ongoing print job, and change the material.</li> </ol>
Maintenance		<ol style="list-style-type: none"> <li>1. Switch plates.</li> <li>2. Reset plates.</li> <li>3. Door control.</li> </ol>
Calibrate		Set Nozzle Height Manually
Information		<ol style="list-style-type: none"> <li>1. Basic Printer Information: Model Name, Serial Number, Firmware Version, Screen Version, Total Print Time, Total Weight of the Material Consumed, LAN M.A.C., WLAN M.A.C..</li> <li>2. Reset Printer</li> </ol>

		Profile. 3.System Language Settings. 4.Touchscreen Update option.
<b>Config</b>		1.Printer Name Information 2.Basic Printer setting: Sound, Preheat, Auto Update, Continuous Print, Private and Password setting
<b>Network</b>		1.Ethernet connection setting 2.WIFI connection setting
<b>Initialize</b>		Initialize the printer

## Material

In the material section, there are Extrude, Withdraw, Change Material Type and Set Total Weight buttons functions.

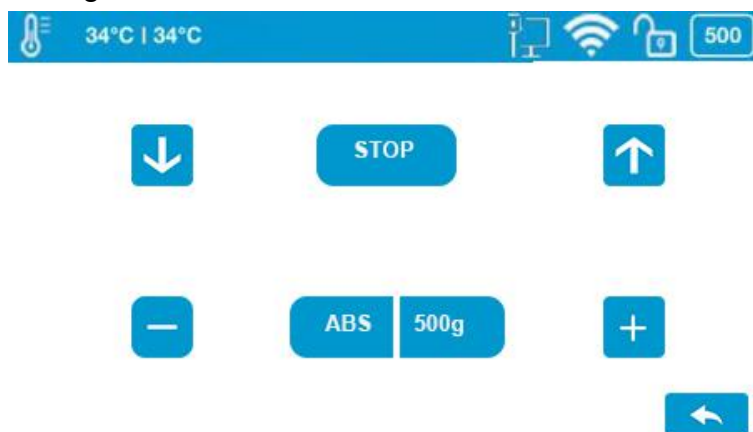





### Material Selection

To change the material type, click the Material Type button, and then input your filament's weight. Make sure the material settings properly reflect your situations, because the default setting may not fit yours.

### Material Icon Description

Name	Icon	Description
<b>Withdraw</b>		To take out the filament inserted in the extruder unit with the preset temperature.  Click the <b>Withdraw</b> icon. The up arrow on the button will start moving upwards, indicating the extruder is heating up. The extruder will start

		<p>pushing the filament out once the temperature reaches the melting temperature with a beep.</p> <p>You now can remove the filament from the tip of the extruder</p>
<b>Extrude</b>		<p>To load the filament into the extruder unit with the preset temperature.</p> <p>Click the <b>Extrude</b> icon. The down arrow on the button will start moving downwards, indicating the extruder is heating up. Once the extruder temperature reaches the filament's melting point, the machine will give off a beep, and you can push the filament into the extruder and the extruder will heat up the filament, and extrude through the nozzle.</p> <p>If the machine works properly, you will find an evenly extruded string of filament coming out of the nozzle, without bubbles or tangling as the extrusion goes on</p>
<b>Stop</b>		<p>To stop the printer in the middle of an extruding or withdrawing process.</p> <p>Click the <b>STOP</b> icon, the up/down arrow on the buttons will stop moving. The printer should stop fully from extruding or withdrawing the filament.</p>
<b>Material Type</b>	<b>PLA</b>	<p>To change the material type.</p> <p>Click the <b>Material Type</b> icon button to change the material type.</p> <p>Also, you can add customized types of material under <b>Maintenance</b> in the software first, and then the new type will be available on the touchscreen for you to select.</p> <p>Default Settings: The default material type is PLA. The default material selection includes ABS, ABS+, PLA, and TPU. The button will show the current selected material type.</p>
<b>Material Weight</b>		<p>To change the total weight the material remaining manually.</p>

		<p>Click <b>Plus</b> icon to increase the value or <b>Subtract</b> icon to decrease the value. The value ranges from 0g- 9999g.</p> <p>The material weight will be adjusted automatically based on how much the material is consumed by print jobs</p> <p>Default Setting: The default value of material weight is 500g.</p>
<b>Exit</b>		<p>Exit the Material section and back back to the main menu</p>

## Print

In the Print section, you can start a print job or manage the print jobs that currently in the print queue (CPL) or have finished.

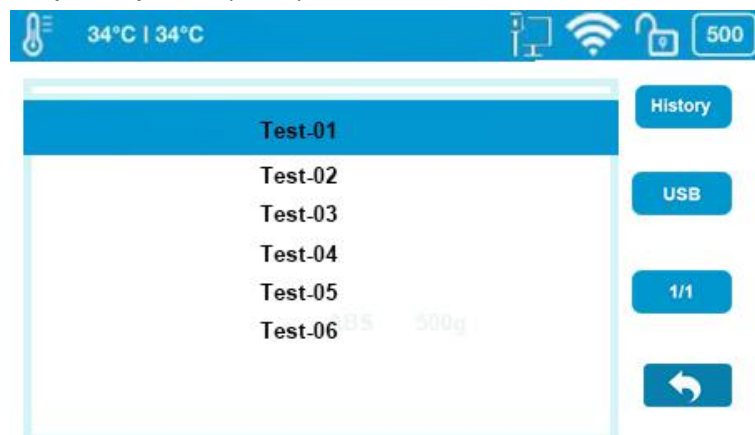





Print

There are three sections: The CPL lists the print jobs that have been assigned to the printer. The HPL contains all the print jobs that have finished. It is the same content that shows in the software Wait Assignment Section. The USB button will show the print jobs lists from external USB stick.

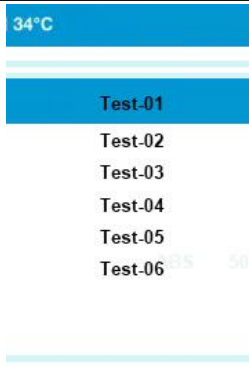

## Print Description



Name	Icon	
<b>Current Print Job List</b>		<p>The print job list contains the print jobs that are assigned to the printer. The highlighted row is the current print job.</p> <p>Click the <b>Print Job Name</b> to view more settings and detail information for the print job. You can start the printing process by clicking Print, or delete the print job by clicking Delete.</p>
<b>History Print Job List</b>		Entering the history list of the print jobs which has previously been printed on the printer, or ended with errors.
<b>USB</b>		Entering the print job list from the external USB stick
<b>Page</b>		Click to go to the next page
<b>Exit</b>		Exit and go back to the main menu

## Print Job History List



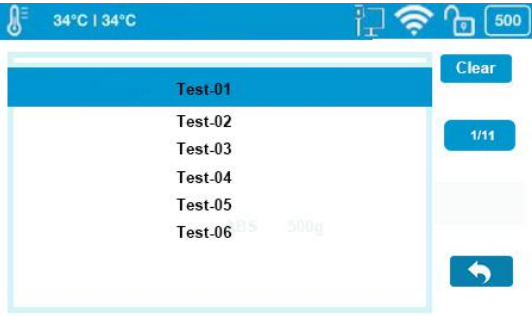

The HPL contains all the print jobs that have finished.

Tap the **Print Job Name** in the list to view the detail print settings. You can add the print job back to the Current Print Job List by tapping the **Add** button. The Clear button will erase the entire history print list.

## Print Job History List

Print Job History List	Print Job Information
	

## Start A Print

Print Description		
Name	Icon	Description
Pause		Pause the on-going print job.
Resume		Resume the paused print job.
Stop		The printer will stop the print job completely.
Extrude		To extrude the inserted filament.
Withdraw		To withdraw the inserted filament.

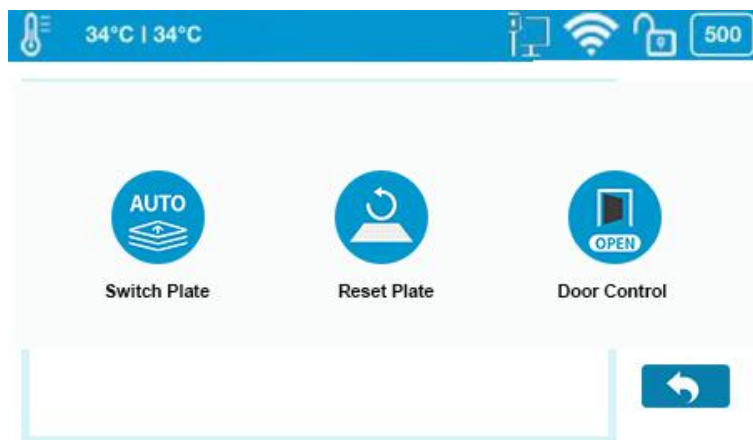

## Maintenance

There are three sections under this function, Switch Plate, Reset Plate and Door Control



**Maintenance Page**

### Maintenance Description

Name	Icon	Description
<b>Switch Plate</b>		Switch the current build plate to the next one
<b>Rest Plate</b>		Reset the current build plate and not switch it to the next one

<b>Door Control</b>		Control the side door to open/close automatically
---------------------	---	---

## Calibrate

The nozzle height of a printer is a key parameter that needs properly set before any print jobs. It can be calibrated manually on X5's touchscreen or set it from UP studio software.



### Calibrate





Click **Edit** on the touchscreen, and enter the suitable value for your printer.

You can also use either +/- button to adjust the value in the Value Box, and then tap the Value Box to move the nozzle to the value height you set in the Value Box.

**Nozzle Height:** is the current printer's nozzle height.

The default value for the nozzle height for each Tiertime printer has been set as 0mm before leaving factory floor for safety reasons. Therefore, calibration is the mandatory step prior to your first print.

### Calibration Icon Description

Name	Icon	Description
<b>Live Nozzle Height</b>		Indicating the present nozzle height.
		Using +/- to adjust the nozzle height manually.
<b>Edit</b>		To edit the nozzle height by inputing numbers manually
<b>Exit</b>		Exit Calibration section and back to main menu.

## Information



Within this section, it displays all the information of your printer, it also provide gateway icons for language setting and touchscreen updating.



- Model:** The Model Name of your printer's model.
- S.N.:** Your printer's ID, which will be required if you looking for customer service.
- Firmware Ver.:** Stands for firmware version of your printer.
- Screen Vers.:** Stands for the touchscreen version. You can check whether your touchscreen is operating using the latest touchscreen system.
- Total Time:** This represents the total printing time of your printer from the beginning.
- Total Weight:** This indicates the total material weight which accumulated from the first print.
- LAN M.A.C:** The unique LAN M.A.C address of your printer in Ethernet .
- WLAN M.A.C:** It's the unique printer's M.A.C address in your Wi-Fi network.



## Information

### Information Icon Description

Name	Icon	Description
Reset		This reset button will erase the following three sets of values which has been stored in your printer. <b>Nozzle height: 0mm.</b> <b>Material type set to PLA, and total weight set to 500g. Name to its defaulted S.N number.</b>
Language		There are two types of languages available for you to choose from, <b>Simplified Chinese Simplified and English.</b>

<b>Update</b>		<b>Users can update the touchscreen manually from a USB stick by tapping this button</b>
<b>Exit</b>		<b>Exit Information section and get back to the main menu.</b>

## Config

Config section contains seven parameters.



### Config

**Name:** it's the printer's name, you can change it on the UP Studio software. The default name is the printer's S.N number.

**Sound:** Toggle the click sound while using touchscreen.

**Preheat:** Toggle the build plate preheating option. If it is on, the machine will start pre-heating 15 minutes ahead of the start of the print job. You can read the introduction of Preheating in Maintenance -> Preheat in the Software User Manual.

**Auto Update:** Toggle the touchscreen update automatically. If switch it off, then the touchscreen can only update manually.

**Cont. Print:** Toggle the continuous print function for the printer

**Private:** Toggle the printer to set a password for private use. Once this option is on, you can set a password for your printer and your printer will not be accessible by other users on the same network without obtaining the password.

**Password:** The password for the printer to protect your printer from other people's access. Click the text field to enter your password.

## Network



This section includes Ethernet Network Settings and Wi-Fi Network Settings.

### Ethernet Network Settings:

1. Plug an Ethernet cable to the LAN socket at the back of X5.
2. The Ethernet connection Status icon should appear in the Printer Status Bar.
3. You now can go to Config to enter Network Settings section.
4. Click Information button to edit the printer's Ethernet Network Settings



**Table 5.10 Network Setting Icon Description**

Name	Icon	Description
Network Type/Name	Network Ethernet	The printer is connect with Ethernet
	Network Tiertime	The name of connected WiFi network.
Static		Toggle the static IP option to edit following settings for static IP
IP	IP 192.168.7.111	This is printer's IP address in the network. Click the text field to edit, click Return to save and exit editing.
Mask	Mask 255.255.255.0	This is printer's mask in the network. Click the text field to edit, click Return to save and exit editing.
Gateway	Gate 192.168.7.1	This is where you define the printer's gateway. Click the text field to edit, click Return to save and exit editing.
DNS	DNS 192.168.1.253	This is where you define the printer's domain name system. Click the text field to edit, click Return to save and exit editing.
Page		Go to the next page.
Exit		Exit and get back to the Network Section.

The following descriptions also applies for Wi-Fi network settings.

#### **Wi-Fi Network Connection and Settings:**

1. Go to **Config**, enter **Network Settings** section.
2. Toggle on **Wi-Fi Network Connection**.
3. Find the desired Wi-Fi Network's name in the list below.
  4. Tap the name to connect the Wi-Fi Network.
  5. The X5 is connect to the Wi-Fi Network successfully, when the red exclamation mark disappeared, a interlock and Information icon appears.
6. Tap the **Information** icon to edit the printer's Wi-Fi Network Settings.

## Initialize

The printer requires initialization before printing.

The Material, Calibration and Print buttons on the Main menu of the touchscreen will be greyed out before the printer is properly initialized.



Click **Initialize** and confirm the printer will start initializing by clicking “√”. After the printer is initialized, you can start sending print jobs to the printer.