

User Manual

MEGA ZERO 2.0

Dear customer,

Thank you for choosing **ANYCUBIC** products.

Maybe you are familiar with 3D printing technology or have purchased **ANYCUBIC** printers before, we still highly recommend that you read this manual carefully. The installation techniques and precautions in this manual can help you avoid any unnecessary damage or frustration.

More information please refer to :

1. <http://www.anycubic.com/>

ANYCUBIC website provides software, videos, models, after-sale service, etc.

Please go to our website to report any issue and we are likely to answer or solve all the questions for you!

2. Facebook page and Youtube channel as shown below.



ANYCUBIC website



Facebook page



Youtube channel

Team **ANYCUBIC**

Safety instruction

Always follow the safety instructions during assembly and usage, to avoid any unnecessary damage to the machine or individual injury



Please contact our customer service first if you have any issue after receiving the products.



Be cautious when using the scraper. Never direct the scraper towards your hand.



In case of emergency, please immediately cut off the power of **ANYCUBIC** 3D printer and contact the technical support.



ANYCUBIC 3D printer includes moving parts that can cause injury.



It is recommended to wear protection glasses when printed models to avoid small particles contacting eyes.



Keep the **ANYCUBIC** 3D printer and its accessories out of the reach of children.



Vapors or fumes may be irritating at operating temperature. Always use the **ANYCUBIC** 3D printer in an open and well ventilated area.



ANYCUBIC 3D printer must not be exposed to water or rain.



ANYCUBIC 3D printer is designed to be used within ambient temperature ranging 8°C-40°C, and humidity ranging 20%-50%. Working outside those limits may result in low quality printing.



Do not disassemble **ANYCUBIC** 3D printer, please contact technical support if you have any question.

Contents

Technical Specification	1
Packing list	2
Product Overview	3
Menu Directory	4
Installation	7
Leveling	12
Manual leveling	12
Supplements to leveling	15
Print model	16
Load the filament	16
Print the model	18
Driver installation	22
Introduction to slicing software	25
Cura installation	25
Machine settings	26
Import the configuration file	29
Manipulate 3D model in Cura	31
Slice and preview	33
Print online	33
Print offline	35
Resume from outage	36
Maintenance	37
Troubleshooting	38

Technical Specification

Printing

Technology:	FDM (Fused Deposition Modeling)
Build Size:	220×220×250 (mm ³)
Print accuracy:	±0.1 mm
Positioning Accuracy:	X/Y 0.0125mm, Z 0.002mm
Extruder Quantity:	Single
Nozzle Diameter:	0.4 mm
Print Speed:	20~100mm/s (suggested 60mm/s)
Supported Materials:	ABS, PLA, TPU, HIPS, PETG, Wood

Temperature

Ambient Operating Temperature:	8°C - 40°C
Operational Heated Bed Temperature:	max 110°C
Operational Extruder Temperature:	max 255°C

Software

Slicer Software:	Cura
Software Input Formats:	.STL, .OBJ, .AMF
Software Output Formats:	GCode
Connectivity:	Memory card; Data cable(expert users only)

Electrical











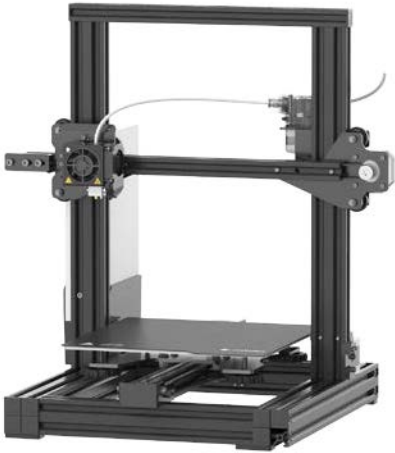





Input rating:	110V/220V AC, 50/60Hz
Output rating:	24V/15A (360W)

Physical Dimensions

Printer Dimensions:	505mm×431mm×607mm
Net Weight:	~7kg



Packing list

			
	Control Box	Filament holder	
		Data cable & Power cord	
Mega Zero 2.0			
			
M4*20 4PCS	M5*6 2PCS	T nut 1PCS	Tool kit
			
M5*45 4PCS	Washer 4PCS	Memory card & Card reader	Assembly instruction
			
Plier	Scraper	Filament (Random color)	After sale service card

Product Overview

Front view

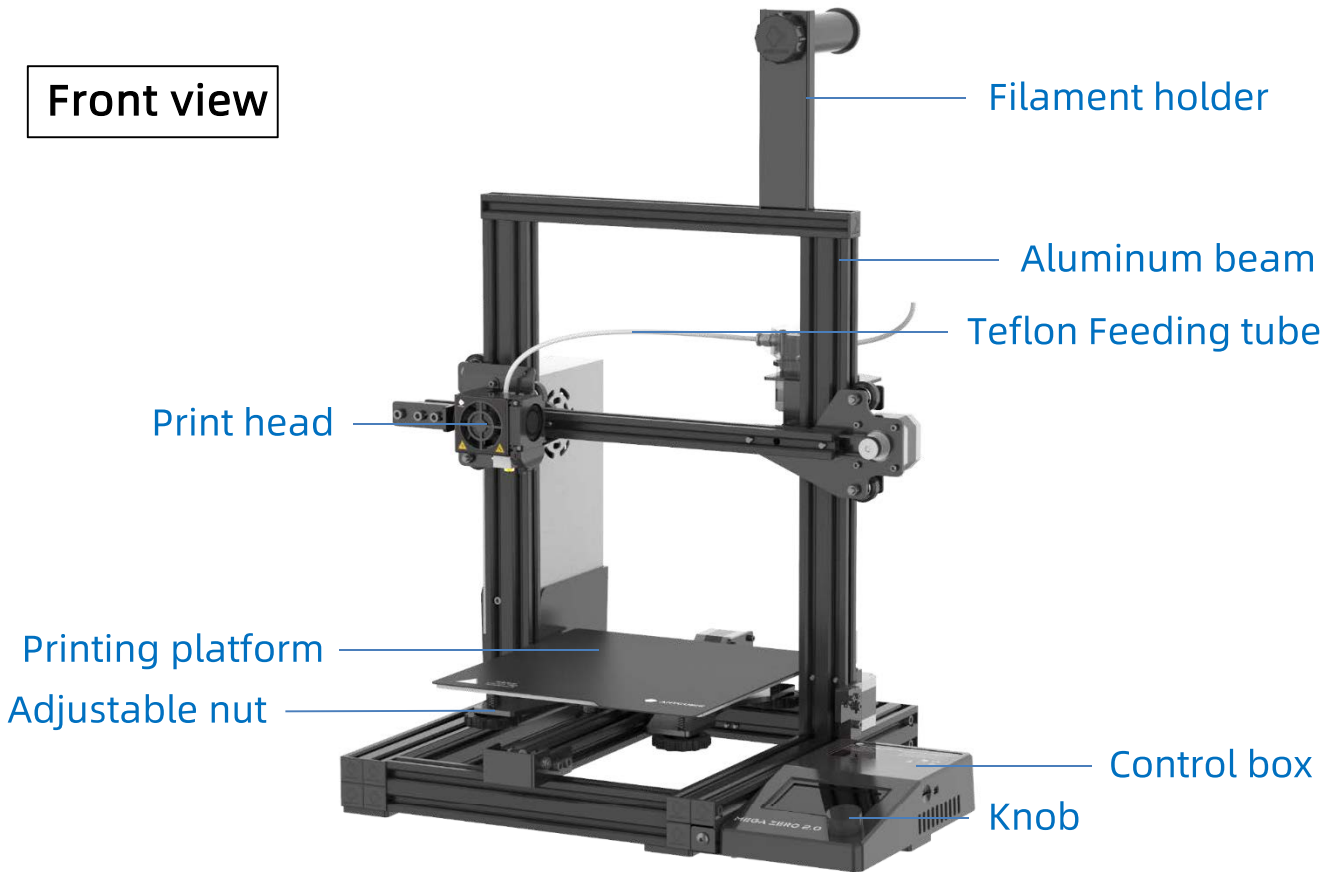

Back view

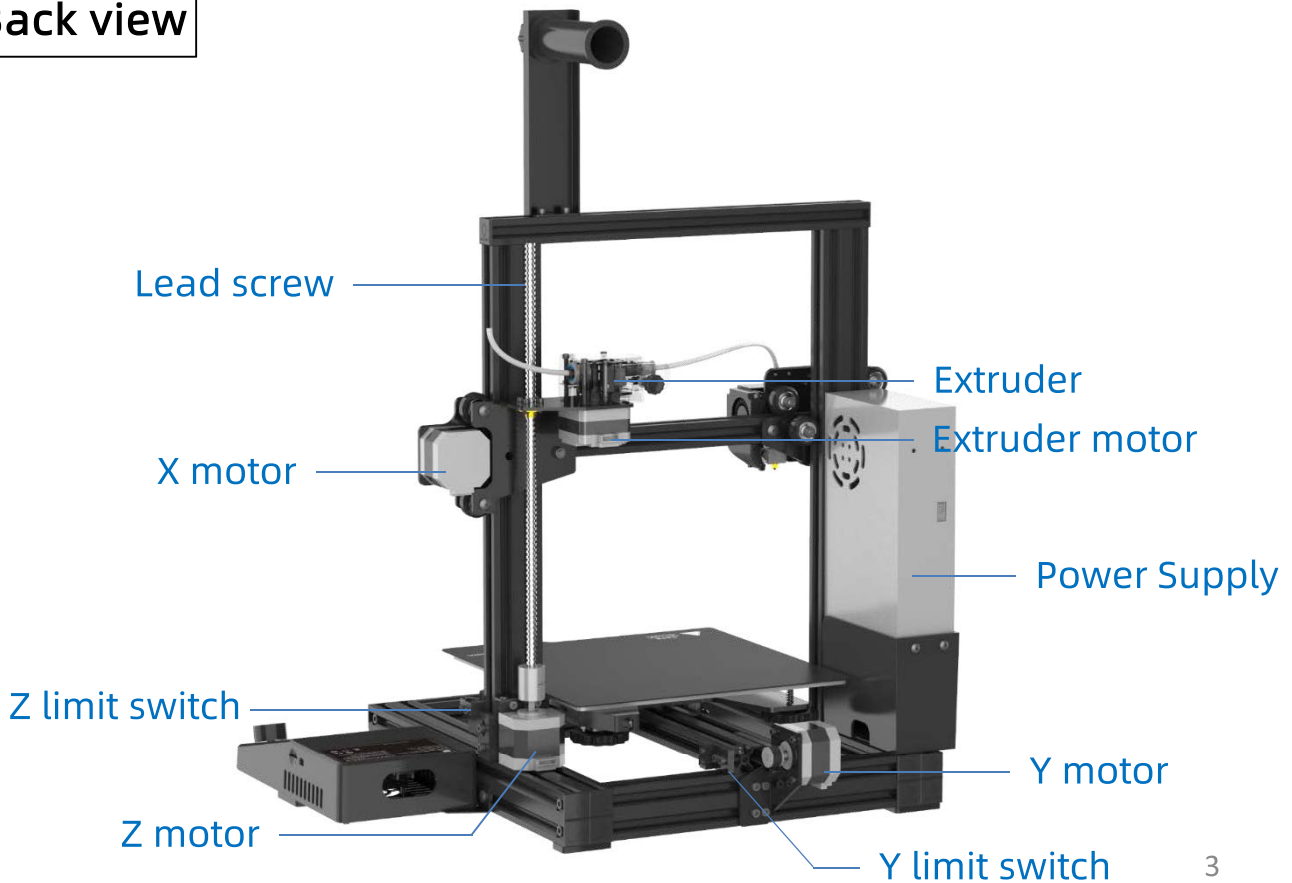

Menu Directory

Information interface

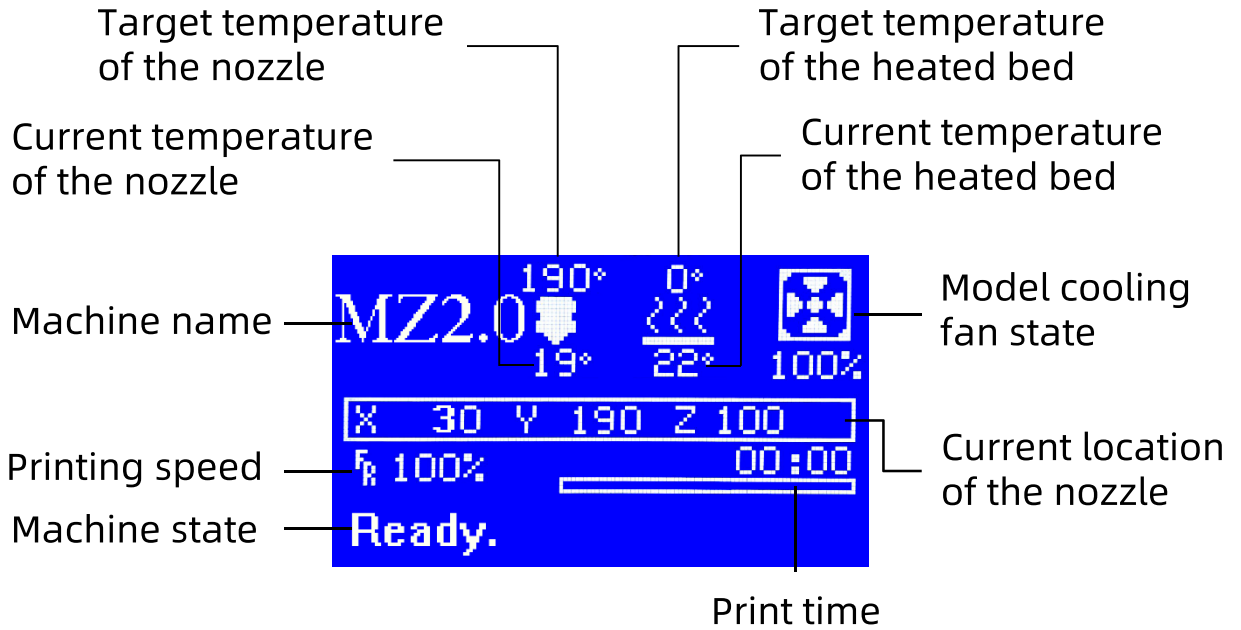

Common Functions

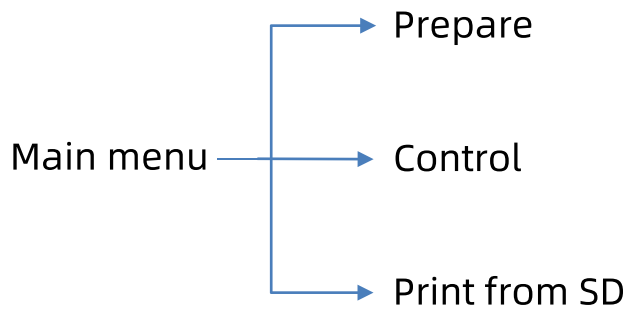

Menu Directory

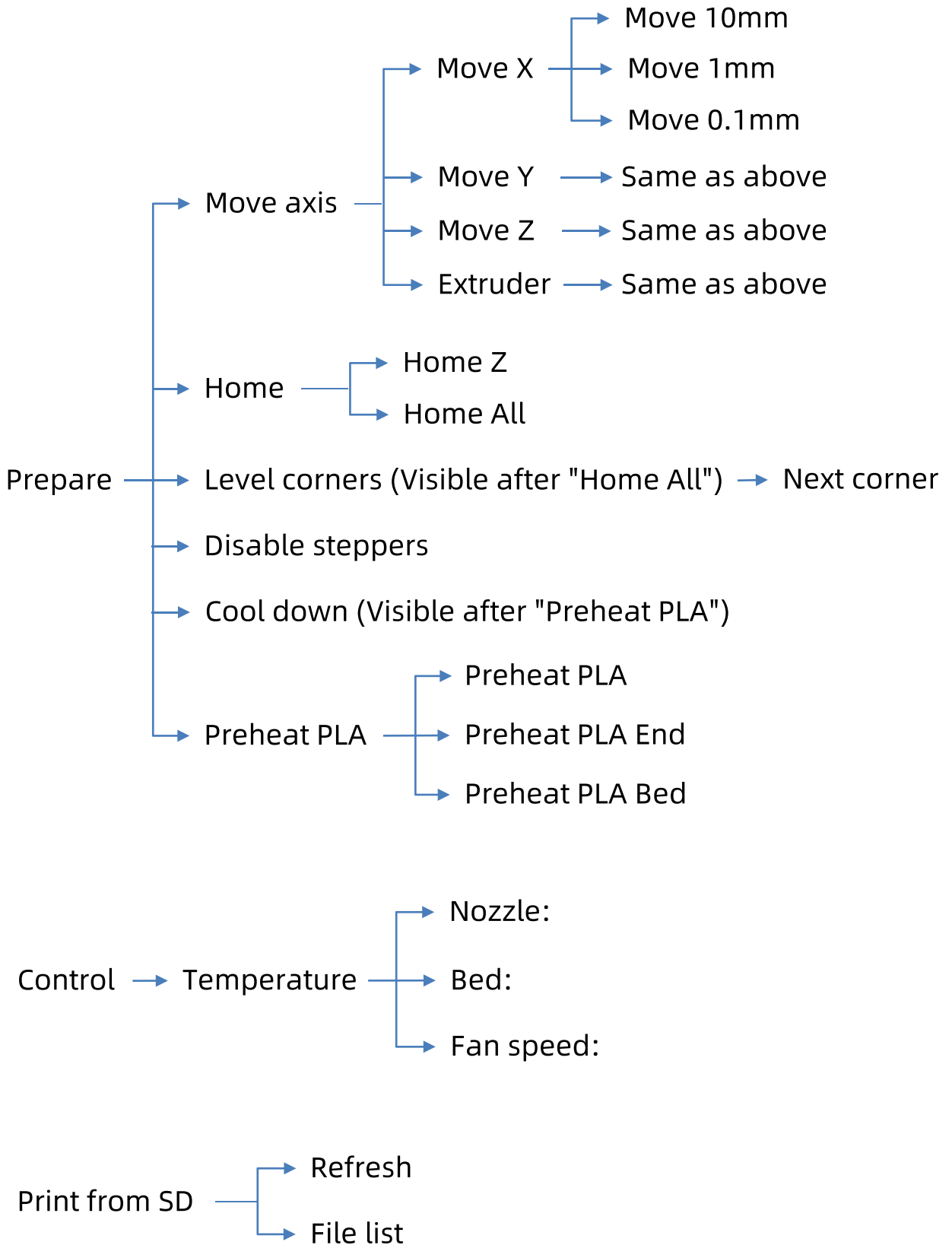

Menu Directory

Common functions in printing

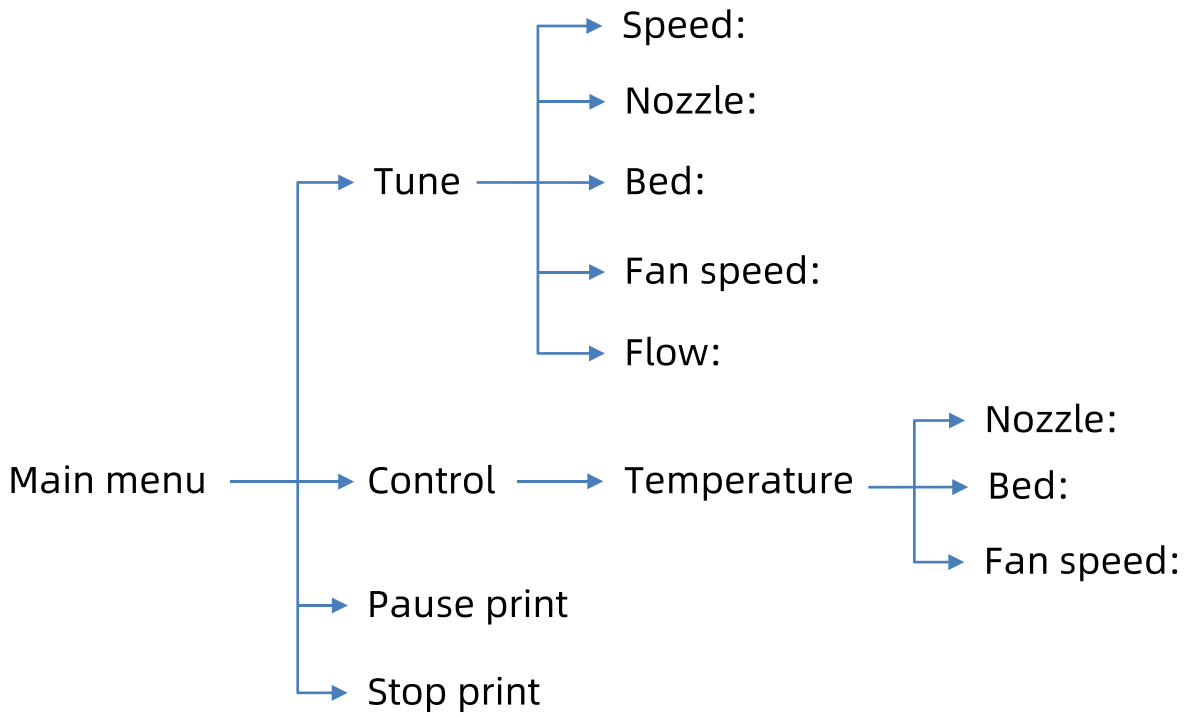

Installation

1. Be cautious during assembly as some parts may have sharp edges.
2. It is suggested to use a flat desktop and place the parts in an orderly manner for quick assembly.
3. The color of some parts may be different from what in the manual, but the assembly is the same.
4. Firmware has been pre-uploaded to the motherboard. After completing the assembly, please level the platform and load the filament then you could start the first test print.

Note: Every unit of the printer has been inspected and tested for printing. Therefore, in some cases, there might be very small marks left on the print head or on the heated bed. Those will not affect the printing quality and those mean the printer has been tested for the quality. The aluminum beams are slightly scratched or the platform is slightly uneven, which is normal under the condition that it does not affect the normal printing. Thank you very much for your kind understanding.

Installation

1. Install frame

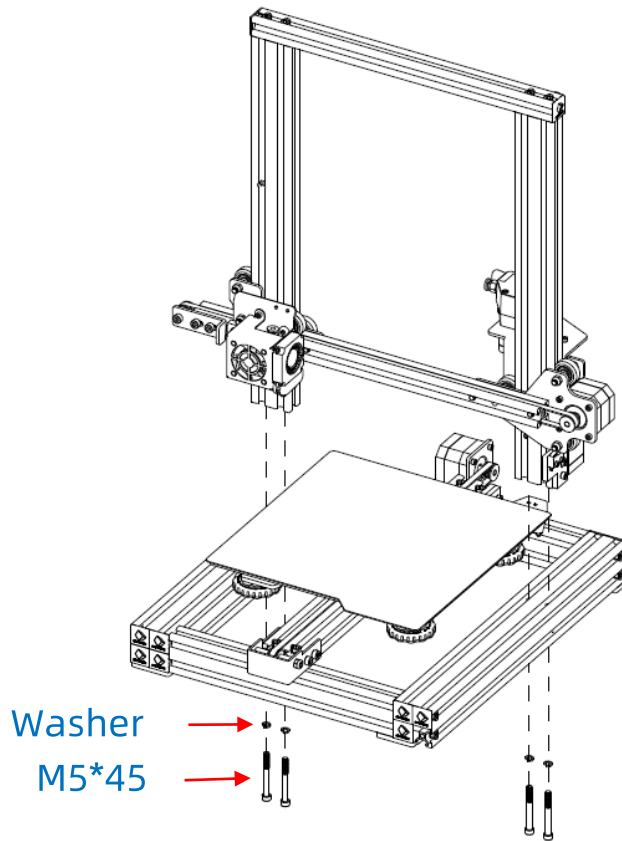

2. Install power box

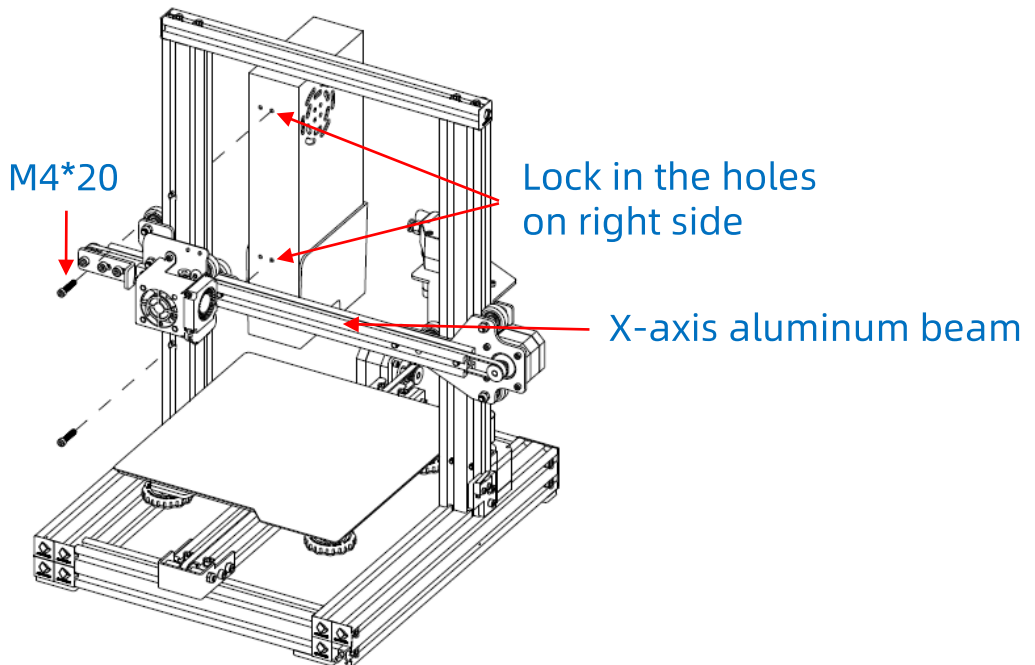

Note: If the holes on aluminum beam are blocked, move the X-axis aluminum up and down to expose them.

Installation

3. Install the filament holder

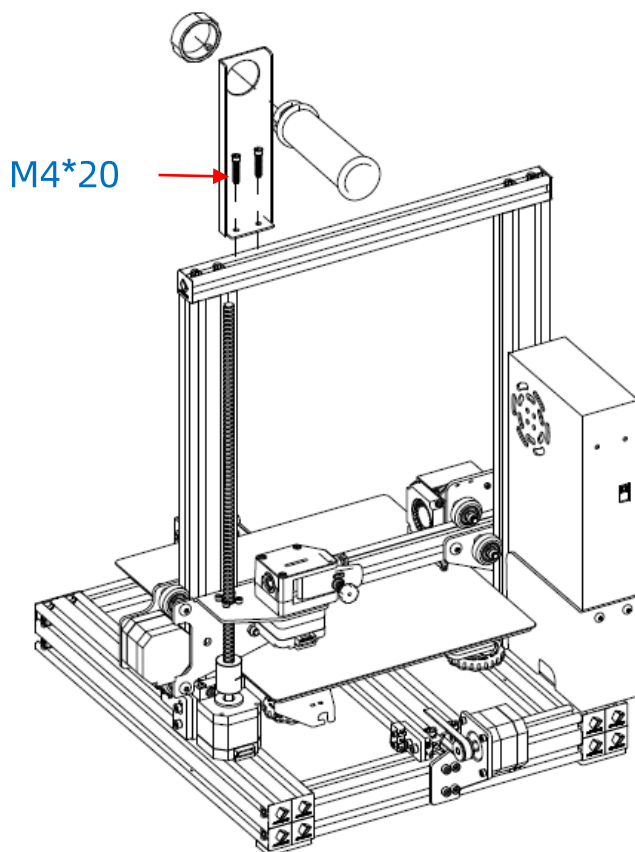

4. Install the control box

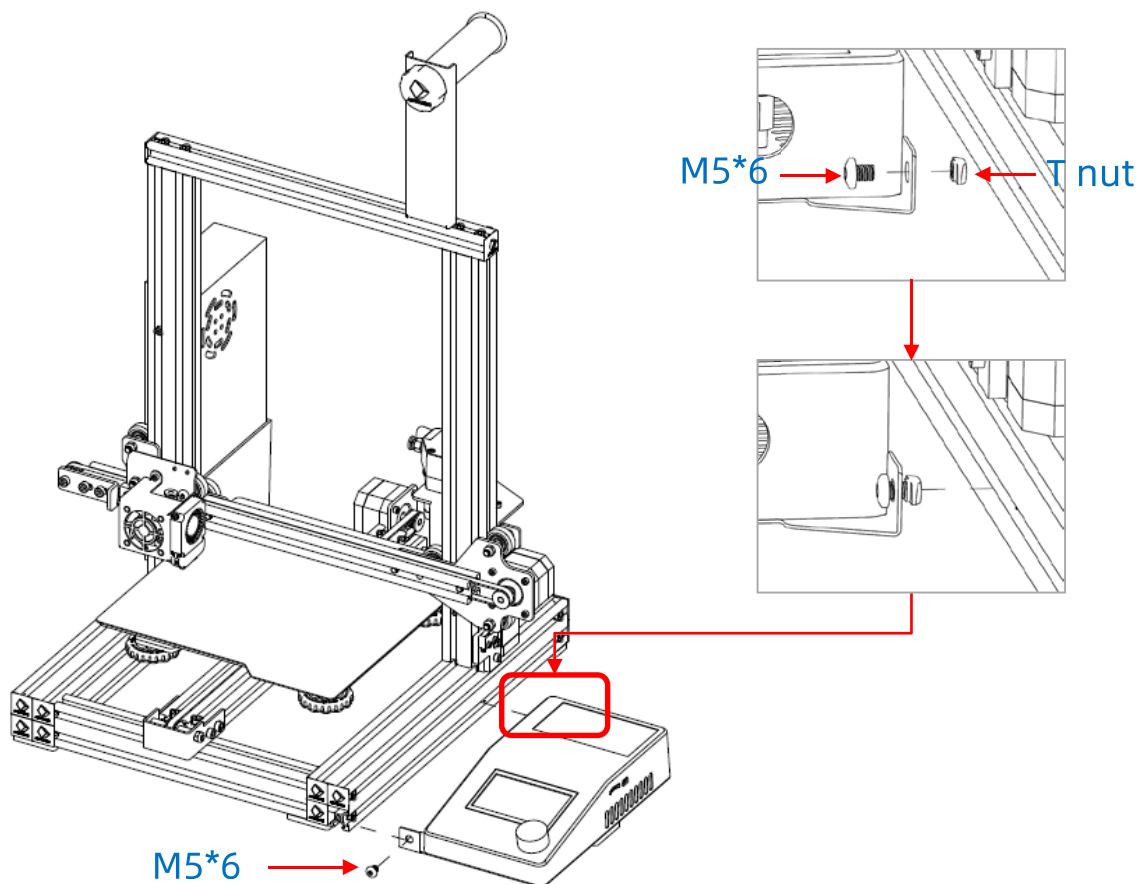

Installation

5. Wiring: connect all these wires to their corresponding ports by the label respectively.

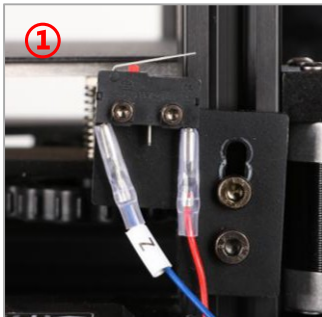

①
Z limit switch
(random color)

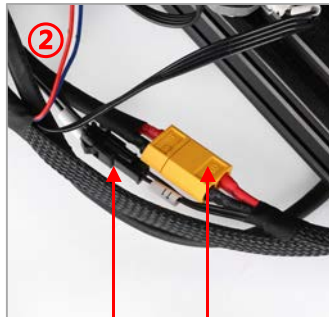

②
NTC wires
heated bed wires

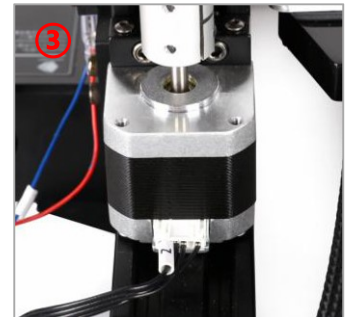

③
Z motor

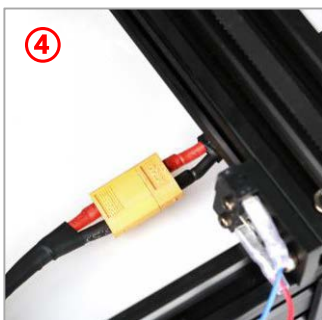

④

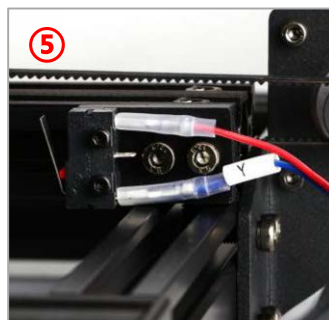

⑤

Y limit switch
(random color)



⑥

Y motor

The power cords should be connected under the aluminum beams without twisting or arching.

Installation

6. Install the magnetic sticker



Attach the magnetic sticker to the platform. Ensure the platform moves without interference when moving it back and forth.

Leveling

It is essential to level the print platform of a 3D printer. Once leveled, it is not necessary to level every time before each printing. Please follow the procedures below:

1. Manual leveling

(1) Select correct voltage mode of the power box according to your local voltage ratings (110V/220V) before plug in. The default setting is 220V.

In some cases, 220V labeled as "230" , 110V labeled as "115"



(2) Power on the machine. Press the knob on the screen to enter the main menu, navigate and press the knob : "Prepare" → " Home" → " Home All" .



Turn to navigate.



Press to confirm.

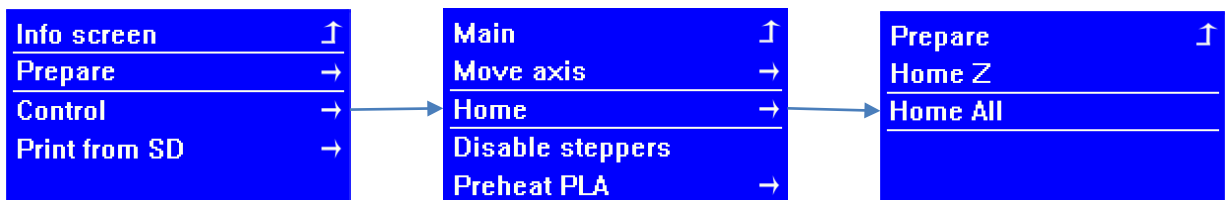

Leveling

(3) After home, press the knob on the screen to enter the main menu, navigate and press the knob : “Prepare”→ “ Level corners”, and the print head will move to the first leveling point.

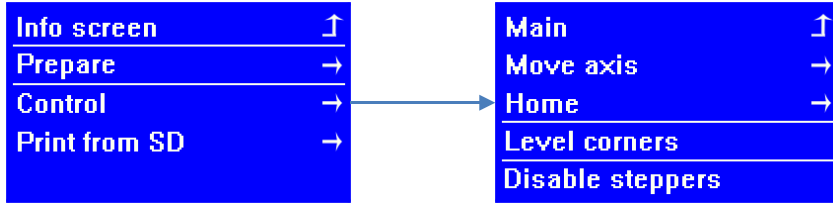

(4) Put a piece of A4 paper at the first leveling point on the printing platform. Then manually adjust (tighten or loosen) the corresponding nut underneath the printing platform. The purpose is to adjust the distance between nozzle and print platform to about the thickness of a piece of paper (~0.1mm). The paper can be pulled with slight resistance.

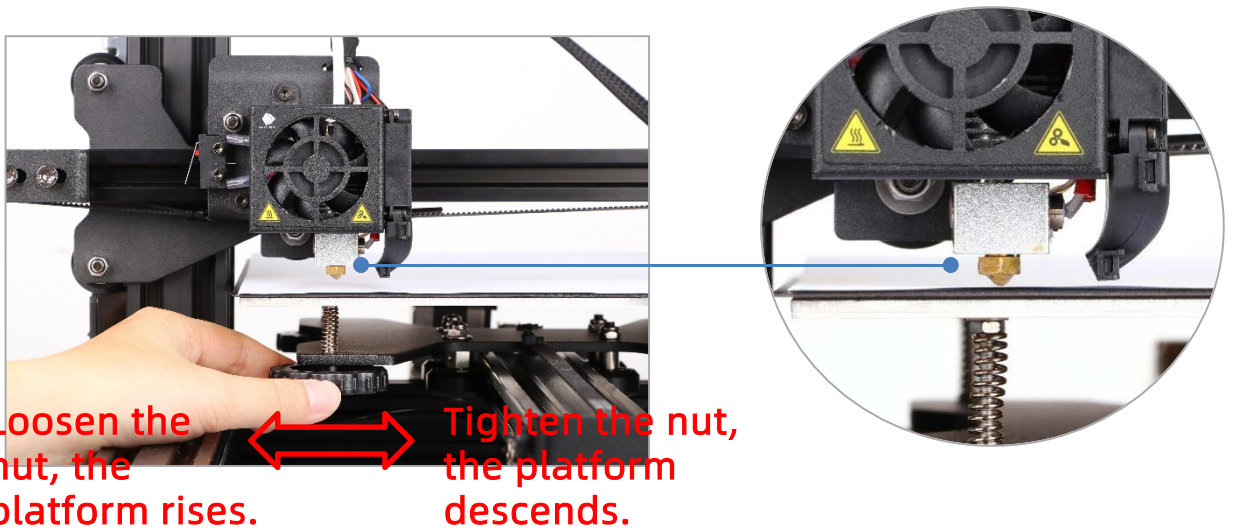

Note: Do not press on the platform when adjusting the nut, otherwise it will affect the leveling accuracy.

Leveling

(5) After the leveling of the first point, Press the knob to choose “Next corner” for the leveling of the next point (refer to the step (4)). The leveling of the four points in the figure below must be completed.

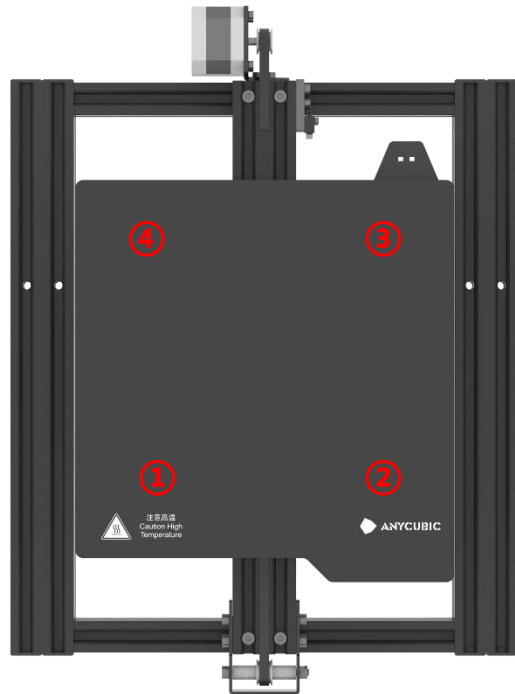
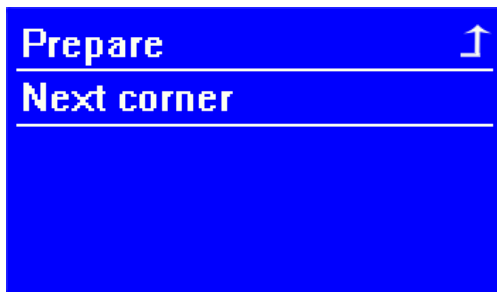

After the leveling of the fourth point, you must choose "Next corner" to return to the first point to level again. Please adjust the 4 points of the platform 2 or 3 times to ensure leveling result is OK, otherwise the platform and nozzle could be worn.

Leveling

2. Supplements to leveling

Case ①: After homing, the nozzle is still much lower than the platform, even if the 4 nuts underneath are fully tightened.

Case ②: After homing, the nozzle is still too far from the platform, even if the 4 nuts underneath are fully loosened.

How to solve this:

Case ①: adjust Z limit switch up.

Case ②: adjust Z limit switch down.

After adjusting, please home and level again.

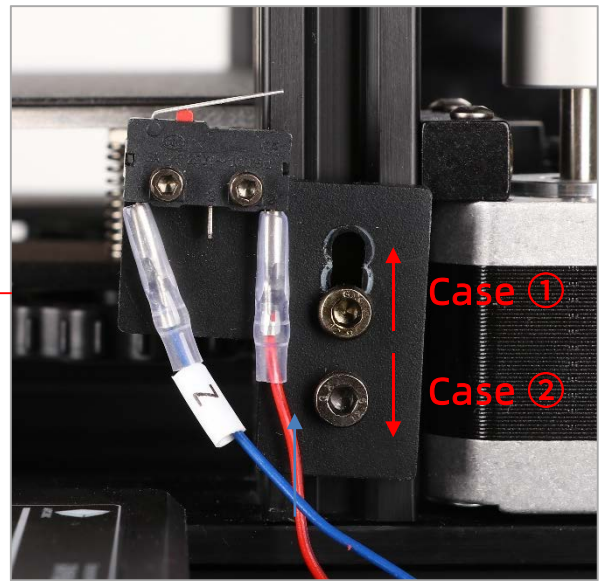
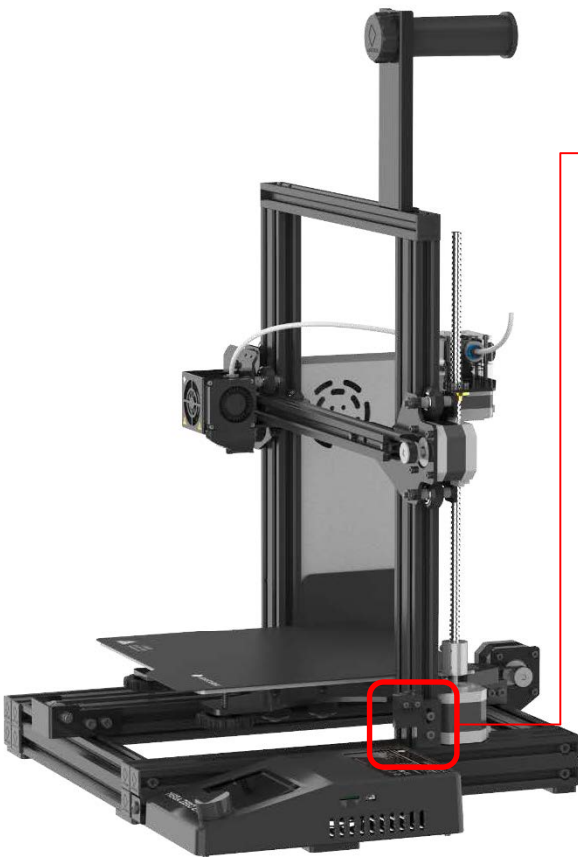

Z limit switch

Print model

1. Load the filament

(1) Return to the main menu, then navigate and press the knob :

“Prepare” → “Move axis” → “Move Z” → “Move 10mm” , turn the knob to set the Z value to 100, and then press the knob to confirm it.

The print head will rise 100mm.

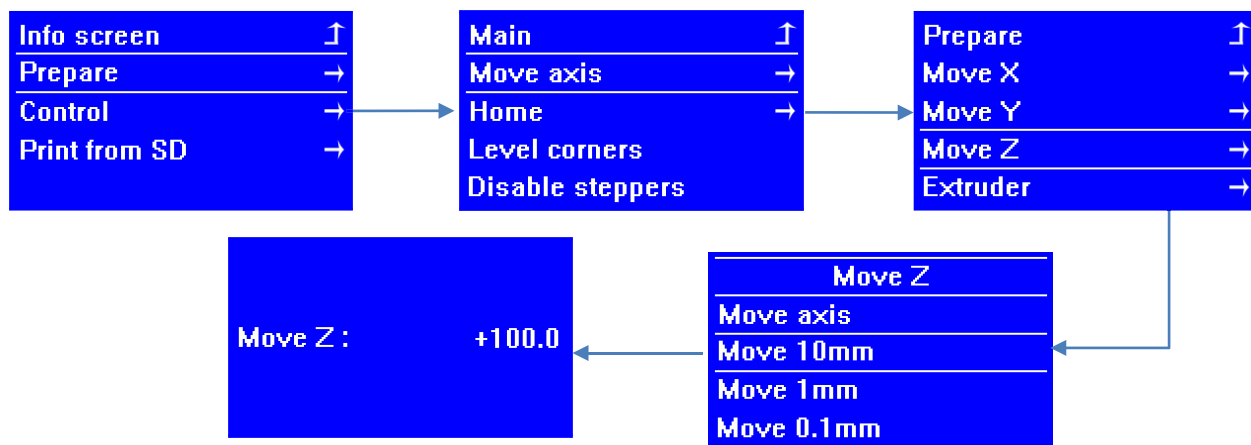

(2) Return to the “Prepare” menu, navigate and press the knob to choose “Preheat PLA” → “Preheat PLA End”. The target temperature of the nozzle in the info screen is 190°C.

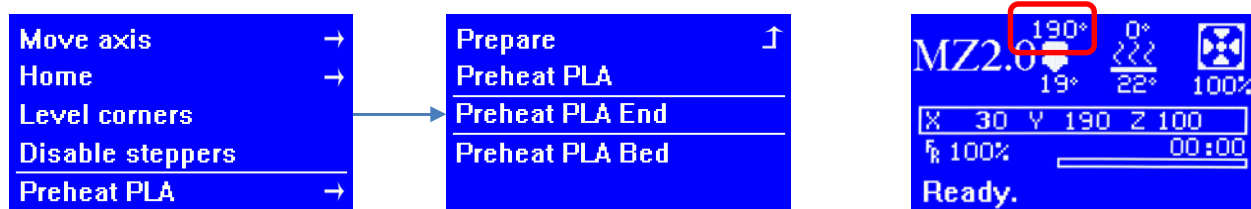

(3) When the nozzle rises to the target temperature, place the filament on filament holder, and note the feeding direction of filament. Straighten the end of filament, then insert the filament into the extruder as shown below.

Print model

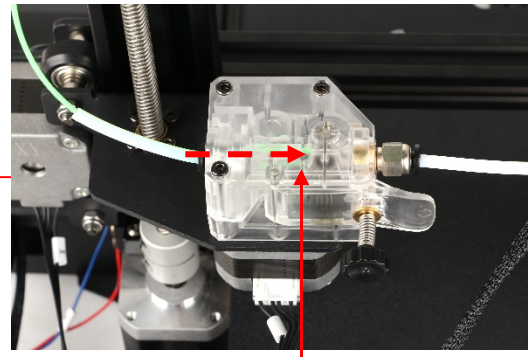
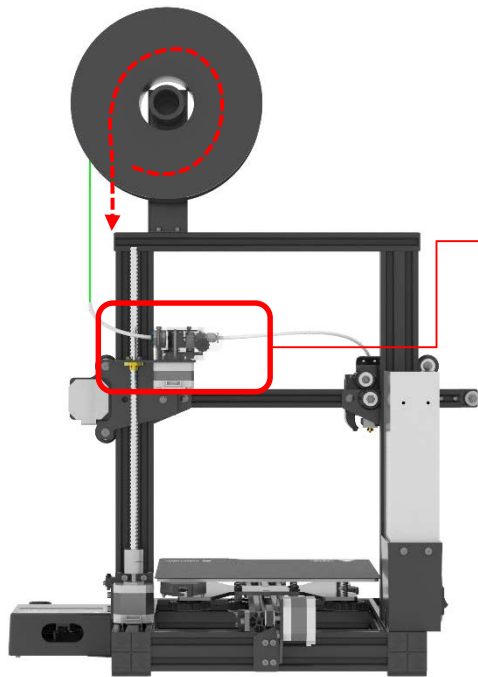

Insert the filament into the extruder till here.

(4) Enter the main menu, navigate and press the knob : “Prepare” → “Move axis” → “Extruder” → “Move 10mm”. Turn the knob until the filament is extruded at the nozzle. Then press the knob to return and clean the filament residue on the nozzle tip.

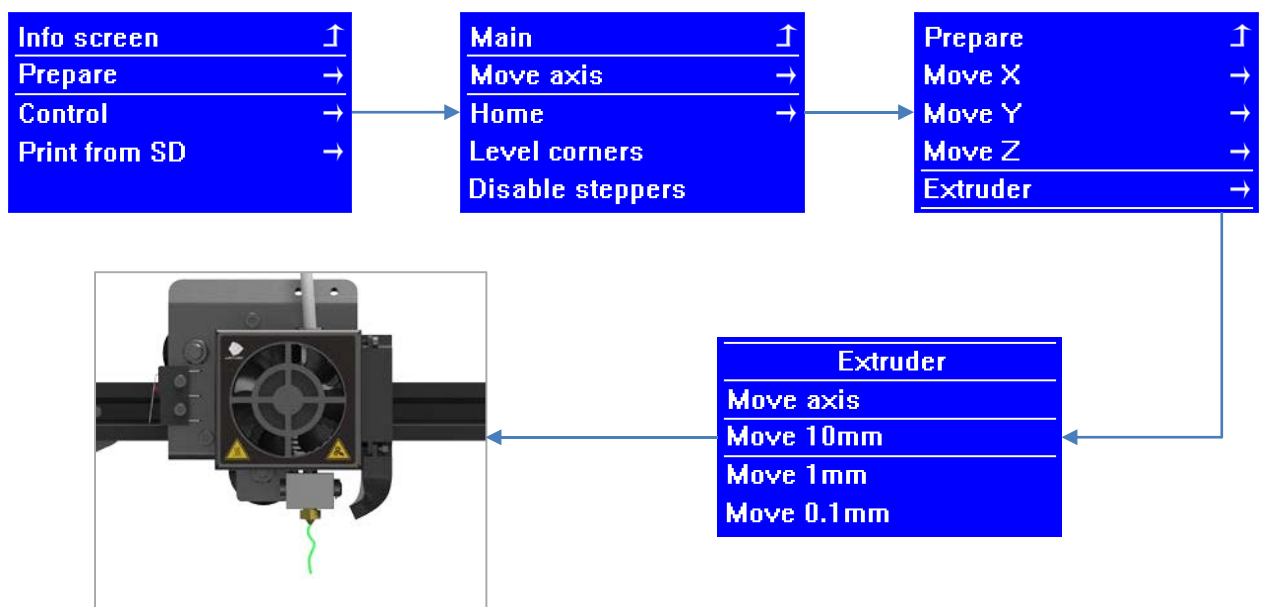

Print model

Note: During feeding, if the melted filament is not smooth or too thin, please adjust the extrusion force by rotating the knob as shown below.



If the melted filament is not smooth, please increase the extrusion force by rotating clockwise.



If the melted filament is too thin, please reduce the extrusion force by rotating counterclockwise.

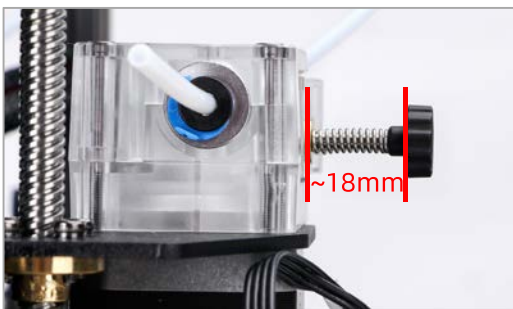

Note: The better distance for extruding filament is about 18 mm. You may adjust the distance of the screw for the different filament.

2. Print the model

Insert the memory card into the memory card slot at the control box. The printable test file has been saved to the memory card. Press the knob on the screen to enter the main menu, navigate and press the knob : "Print from SD" → "owl.gcode" (owl, author: etotheipi, www.thingiverse.com). (If the test file "owl.gcode" is not display, please press the knob to choose "Refresh".)

Print model

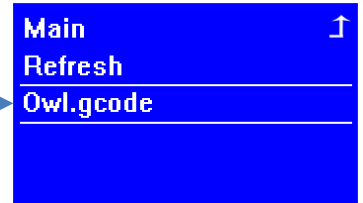
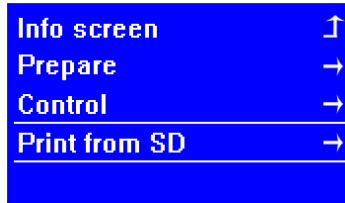

There might be 3 kinds of results for the first layer of the test prints.

A: Nozzle too low, lack of extrusion, the nozzle rub against the platform. Slowly tighten the corresponding nuts underneath by half circle or level again.

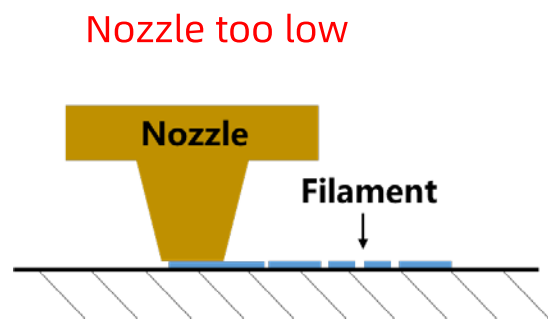

B: Proper nozzle height, good extrusion and adhesion.

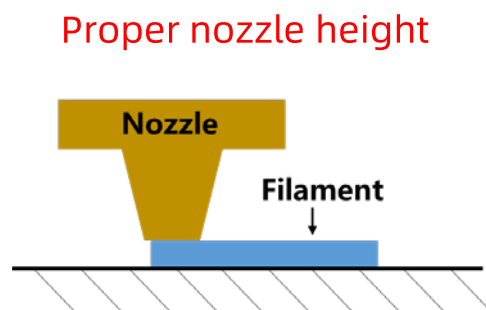

Print model

C: Nozzle too high, large gap, filaments do not even adhere to the platform. Slowly loosen the corresponding nuts underneath the platform by half circle or level again.

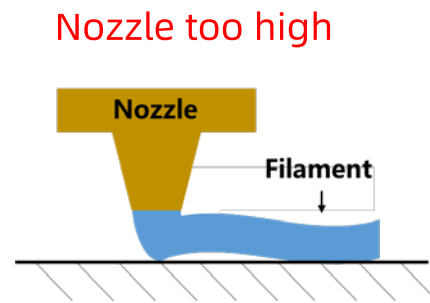

If you can't improve the model printing effect by fine-tuning the adjustable nuts, please level again.

Nozzle and platform are still in high temperature when printing is finished, Please be cautious to avoid injury. Wait for them to cool before removing the magnetic sticker. And then slightly bend it and remove the model.



Print model

After several times of leveling, if the printing effect is still poor, it may be that the D-shape wheels do not run smoothly or idle during printing. The D-shape wheels has been adjusted in factory, but they may be loose due to transportation.

Check the D-shape wheels: Pull the X module up and down. If the D-shape wheels along Z axis do not roll smoothly or idle, use a wrench to slowly turn the hexagonal pillars until the D-shape wheels roll smoothly.

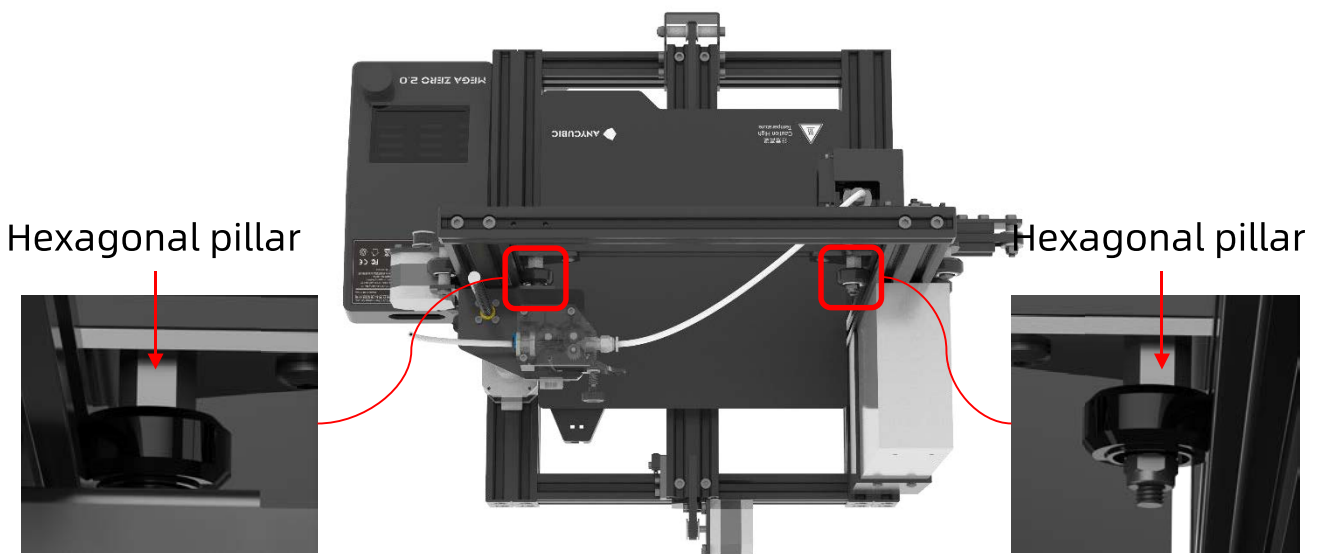

Check the D-shape wheels and the hexagonal pillars on both sides, and make sure they run smoothly after adjustment.

Driver installation

There are two operational modes for Mega Zero 2.0 : print offline and print online.

Print offline: As shown previously, insert memory card to right side of the control box, press the knob to select “Print from SD” and print a selected file (GCode files ONLY).

Print online: Install CH340 driver to bridge PC and machine, and install Cura for slicing and control the machine to print via data cable.

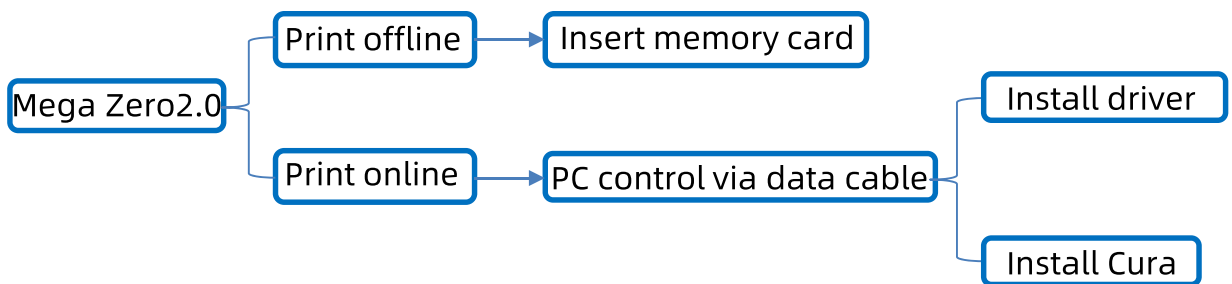

It is suggested to use **Print Offline** mode to minimize the noisy signal via data cable.

How to install the software to enable PC control (print online).

First, turn on the machine, connect the printer (data cable port) and your PC via data cable. Mega Zero 2.0 uses CH340 chip for communication. The CH340 driver may not be installed automatically, so it is required to check that. Right click “This PC”→ “Properties”→“Device manager”, if there is an exclamation mark as shown below, it needs to be installed manually.

Driver installation

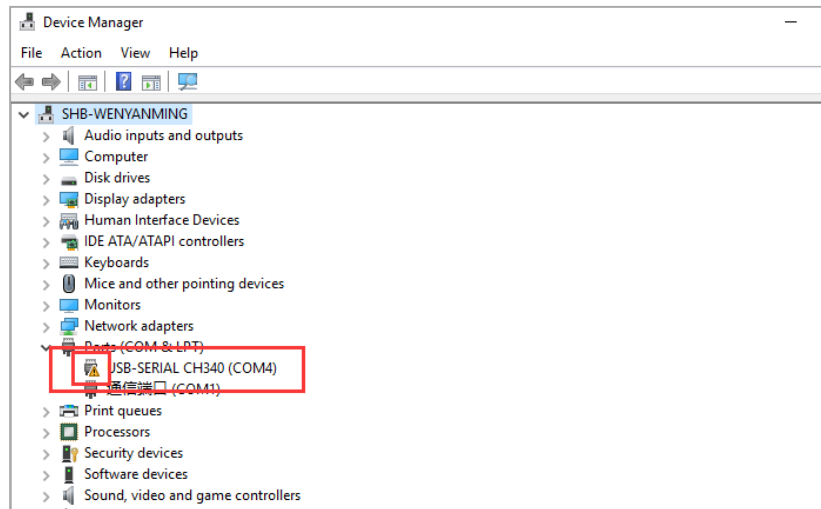

CH340 driver file are located in the memory card (or visit our website to download). "Files_English_MEGA ZERO 2.0" → "Driver_CH341" → "Windows" (CH341 driver file is suitable for CH340 chip).
Double click "CH341SerSetup.exe" to install it.

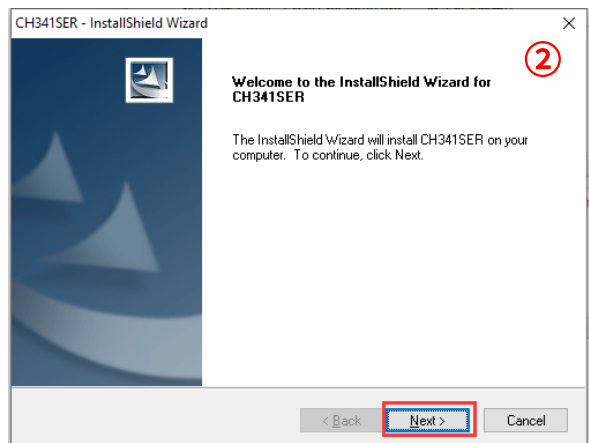
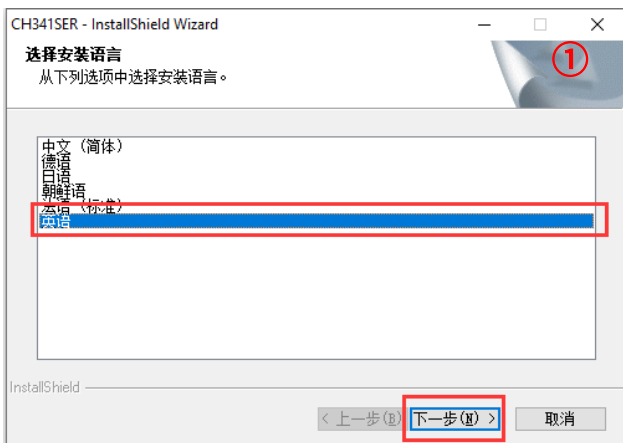

Driver installation

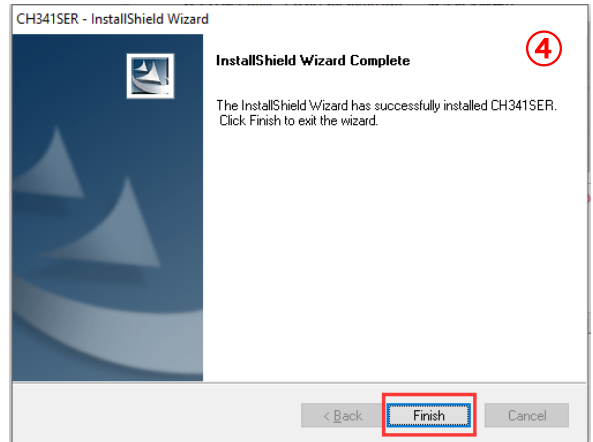
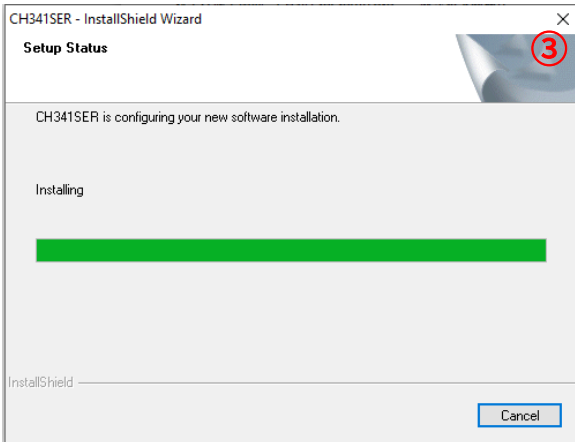

Right click "This PC" → "Properties" → "Device manager" to check, you can see that the exclamation mark has disappeared.

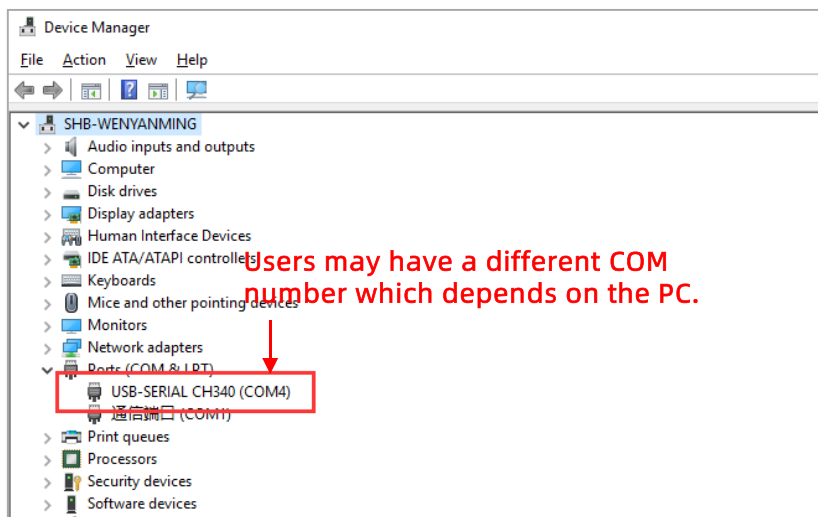

Introduction to slicing software

Introduction of slicing software: ①Cura installation, ②Machine settings, ③Import the configuration file , ④ Manipulate 3D model in Cura, ⑤Slice and preview, ⑥Print online, ⑦Print offline

1. Cura installation

3D printer reads Gcode file and prints. It is necessary to convert 3D files (such as stl file) into Gcode files for machine to recognize. Software that convert 3D files into Gcode files is called slicing software.

Ultimaker_Cura-4.2.1-win64 is used for example here (Users may use their own slicing software). It is located in memory card→“ Files_English_MEGA ZERO 2.0”→“ Cura”→“ Windows”. Double click “Ultimaker_Cura-4.2.1-win64.exe”, and follow the steps as shown below.

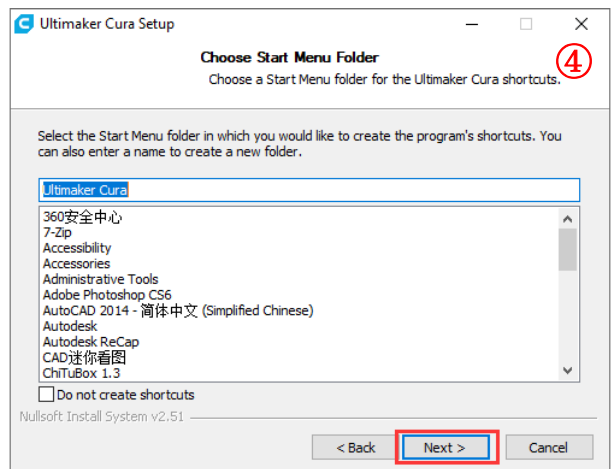
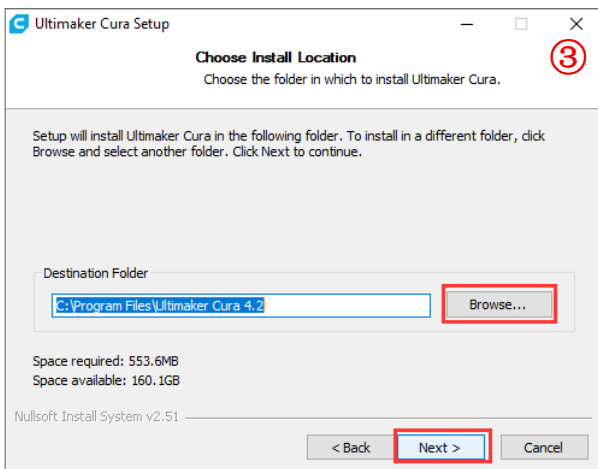
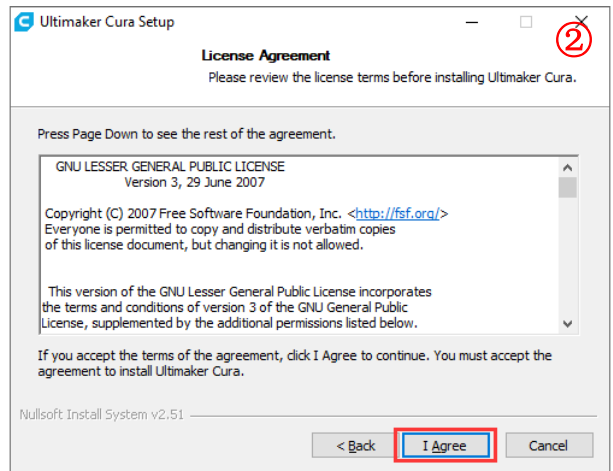
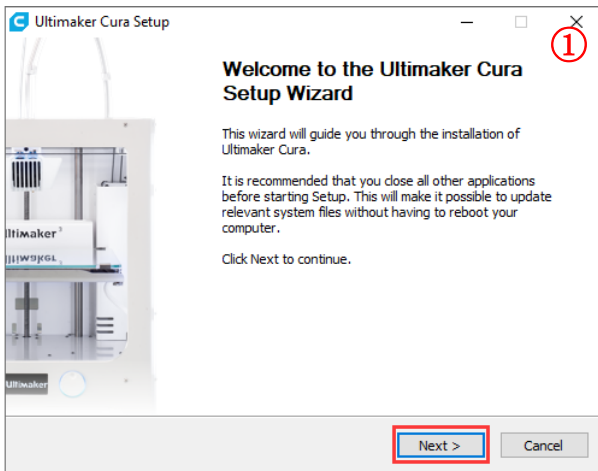

Introduction to slicing software

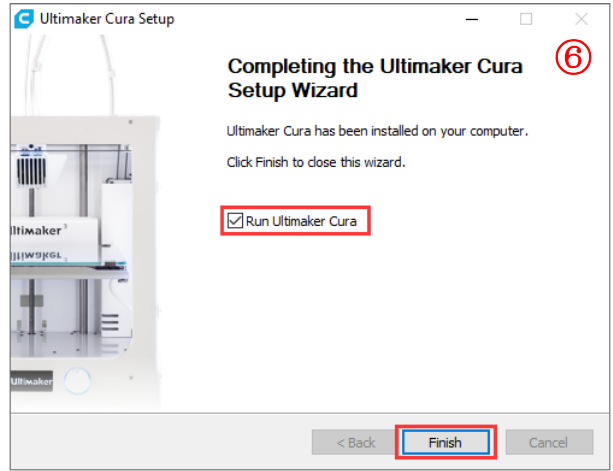
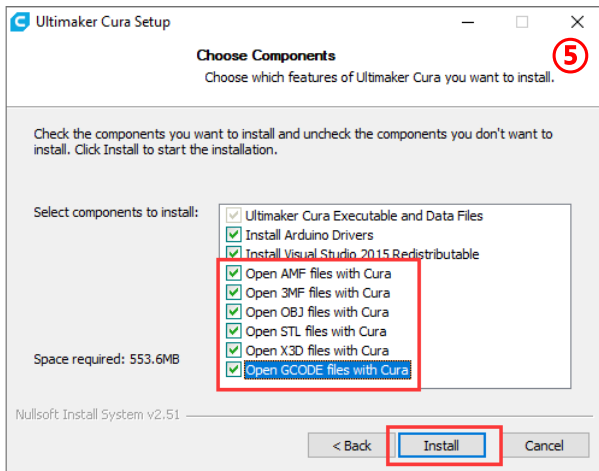

Note: Printing online requires the installation of a driver, as shown below. If you don't print online, you don't need to install it.

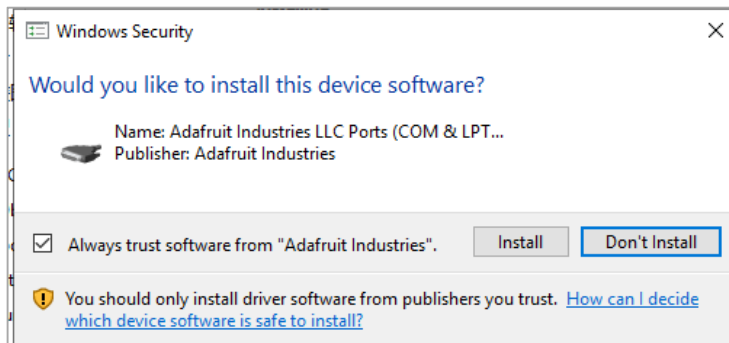

2. Machine settings

Upon completion of installation, the first launch of the software will display the following welcome screen. Click "Get started" to start the machine settings.

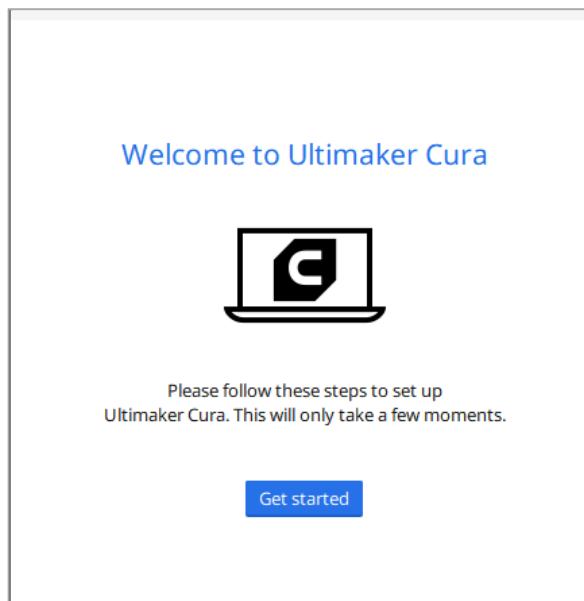

Introduction to slicing software

①

User Agreement

Disclaimer by Ultimaker

Please read this disclaimer carefully.

Except when otherwise stated in writing, Ultimaker provides any Ultimaker software or third party software "As is" without warranty of any kind. The entire risk as to the quality and performance of Ultimaker software is with you.

Unless required by applicable law or agreed to in writing, in no event will Ultimaker be liable to you for damages, including any general, special, incidental, or consequential damages arising out of the use or inability to use any Ultimaker software or third party software.

Decline and close

Agree

②

What's new in Ultimaker Cura

4.2.0

Orthographic view.

When preparing prints, professional users wanted more control over the 3D view type, so this version introduces an orthographic view, which is the same view type used by most professional CAD software packages. Find the orthographic view in View > Camera view > Orthographic, and compare the dimensions of your model to your CAD design with ease.

Object list.

Easily identify corresponding filenames and models with this new popup list. Click a model in the viewport and its filename will highlight, or click a filename in the list and the corresponding model will highlight. The open or hidden state

Next

③

Help us to improve Ultimaker Cura

Ultimaker Cura collects anonymous data to improve print quality and user experience, including:

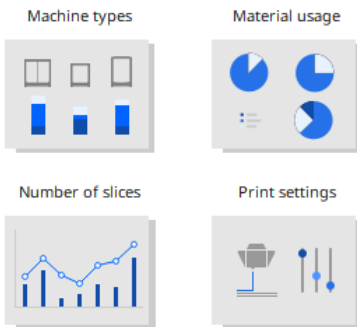

Data collected by Ultimaker Cura will not contain any personal information. [More information](#)

Next

④

Add a printer

Add a networked printer

There is no printer found over your network.

Refresh

Add printer by IP

Troubleshooting

Add a non-networked printer

Next

⑤

Add a printer

Add a networked printer

Add a non-networked printer

- ▼ Anycubic
 - Anycubic 4Max
 - Anycubic Chiron
 - Anycubic i3 Mega
- > Ateam Ventures Co. Ltd.
- > BEEVERYCREATIVE
- > BFB
- > BIBO
- > BQ
- > Builder
- > Cocoon Create

Printer name Anycubic i3 Mega

Next

⑥

Ultimaker Cloud

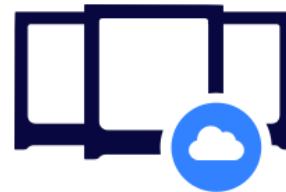

The next generation 3D printing workflow

- Send print jobs to Ultimaker printers outside your local network
- Store your Ultimaker Cura settings in the cloud for use anywhere
- Get exclusive access to print profiles from leading brands

Create an account

Sign in

Finish

Introduction to slicing software

According to the wizard, we have selected the "Anycubic i3 Mega" model. Now, we will set the model parameters of Mega Zero 2.0 based on that model.

(1) Click "Manage printers", as shown below.

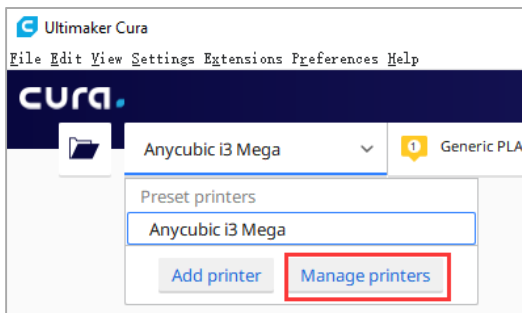

(2) Click "rename" to change the machine name to "Anycubic Mega Zero 2.0", and then click "Machine Settings".

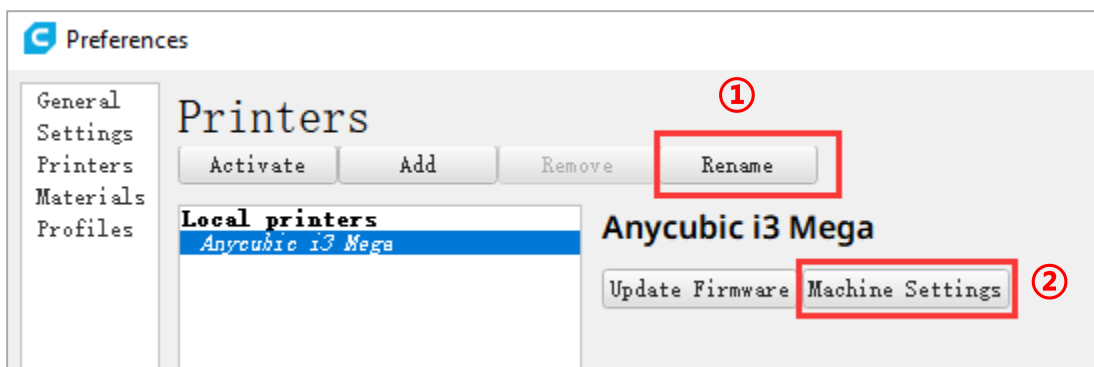

(3) Modify the "XYZ" parameters as 224, 224 and 250 respectively on the "Machine Settings" page, as shown below.

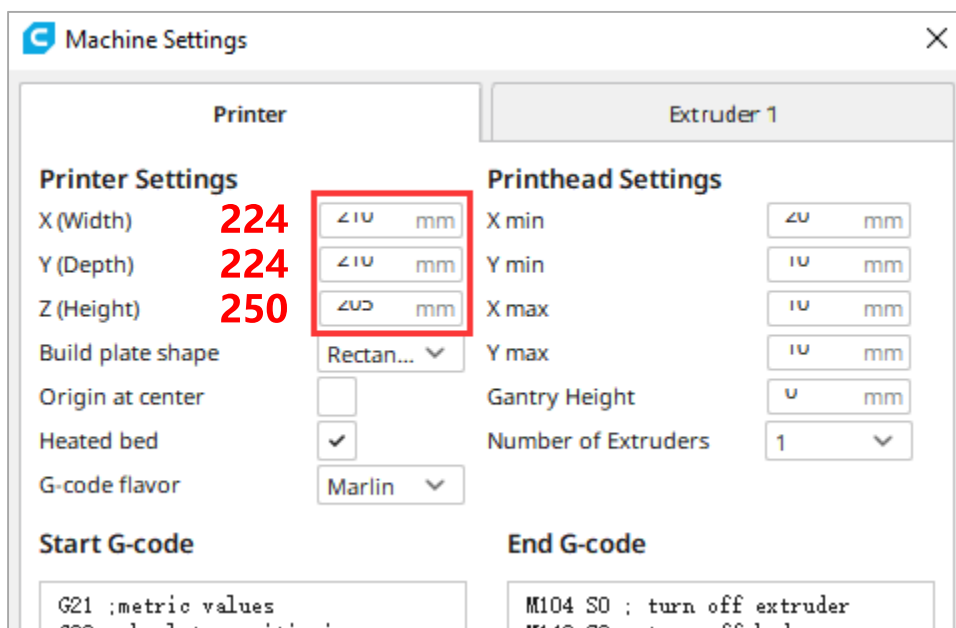

Introduction to slicing software

3. Import the configuration file

After continuous testing, we provided users the suggested printing parameters of different filaments for Mega Zero 2.0, and the user could directly import the parameter files in the memory card to the software.

(1) Click "Settings"- "Configure setting visibility...", and then check "Check all" to make all settings visible.

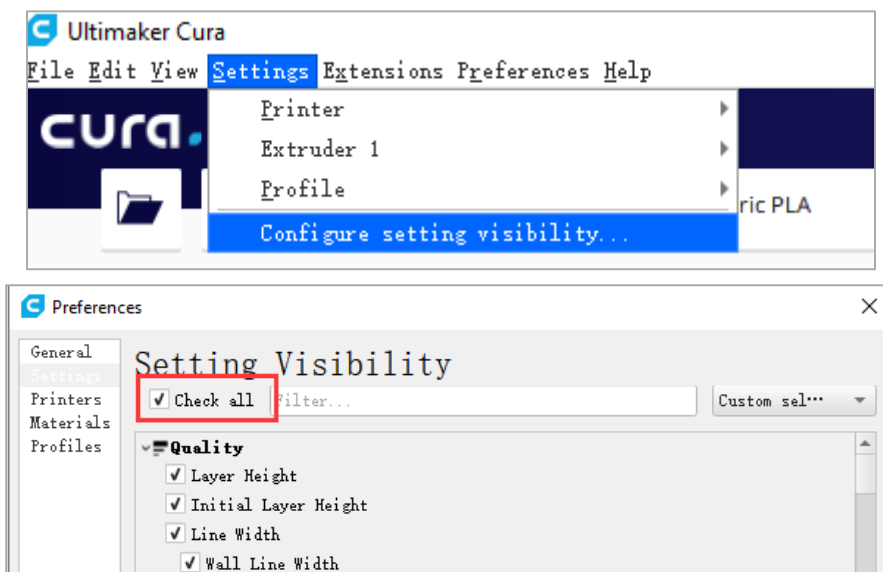

(2) Click "profile" on the left, and then click "import" to open the "import profile" dialog box, then select the "Suggested parameters MEGA-ZERO2.0-PLA. curaprofile" or other files (file path: memory card → "File _ English _ MEGA ZERO2.0"), and click "open". After successful import, the following success prompt will pop up.

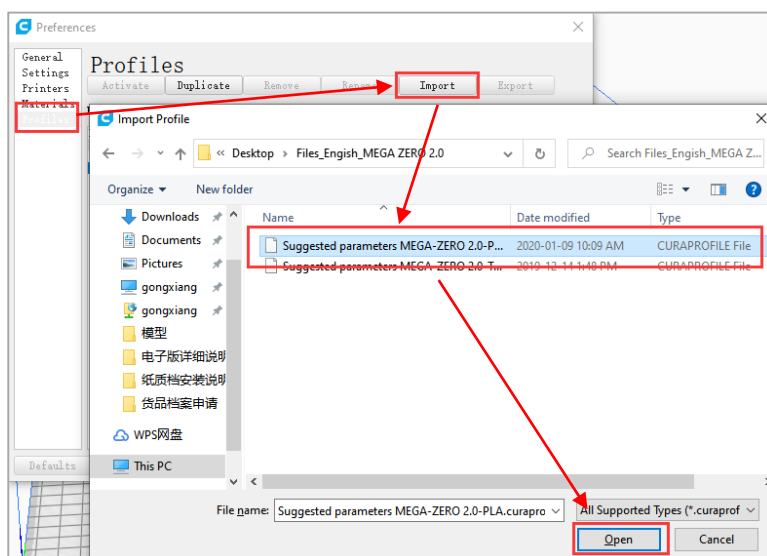

Introduction to slicing software

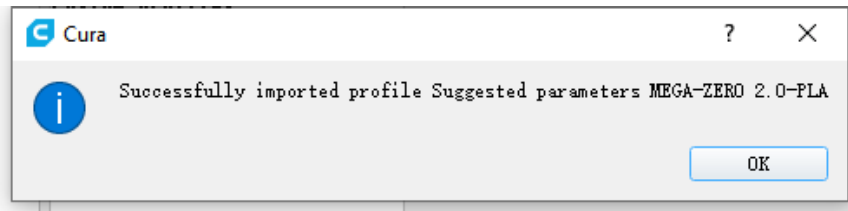

(3) Select the configuration file that you just imported.

Click to open
"Print settings"

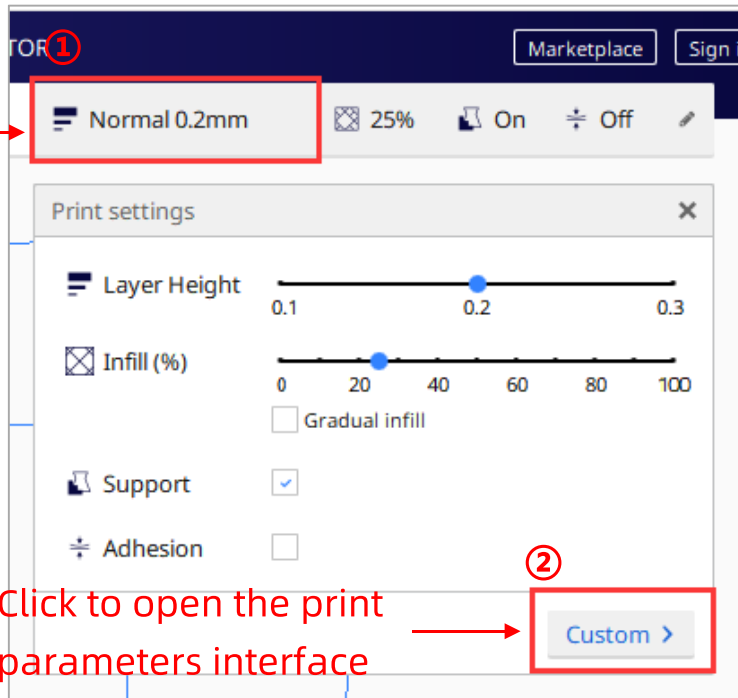

Click to open the print
parameters interface

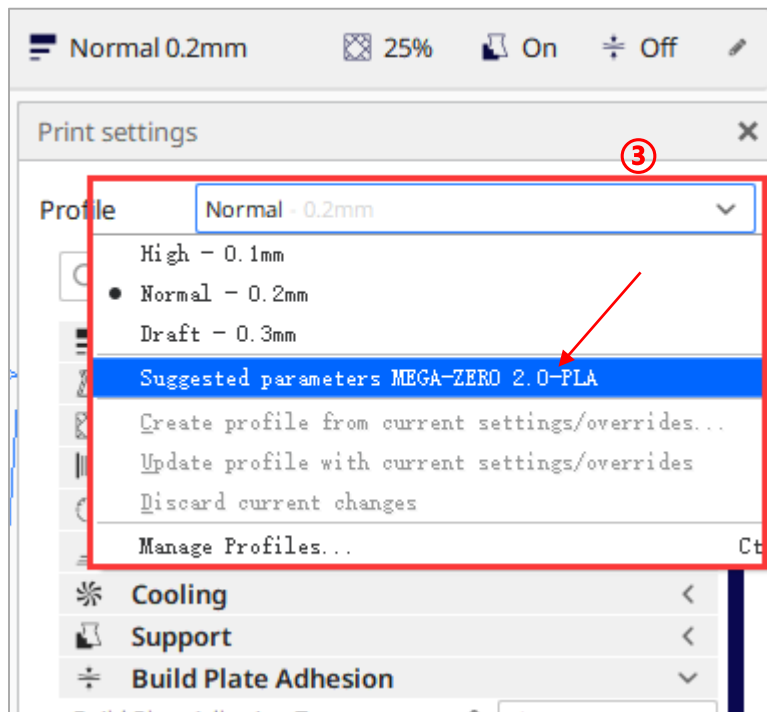

Introduction to slicing software

4. Manipulate 3D model in Cura

In the Cura software interface, click on the “File” → “Open File(s)...” to import your own three-dimensional format model (such as .stl file).

Users can “Rotate” “Scale” “Mirror” the model. As shown below:

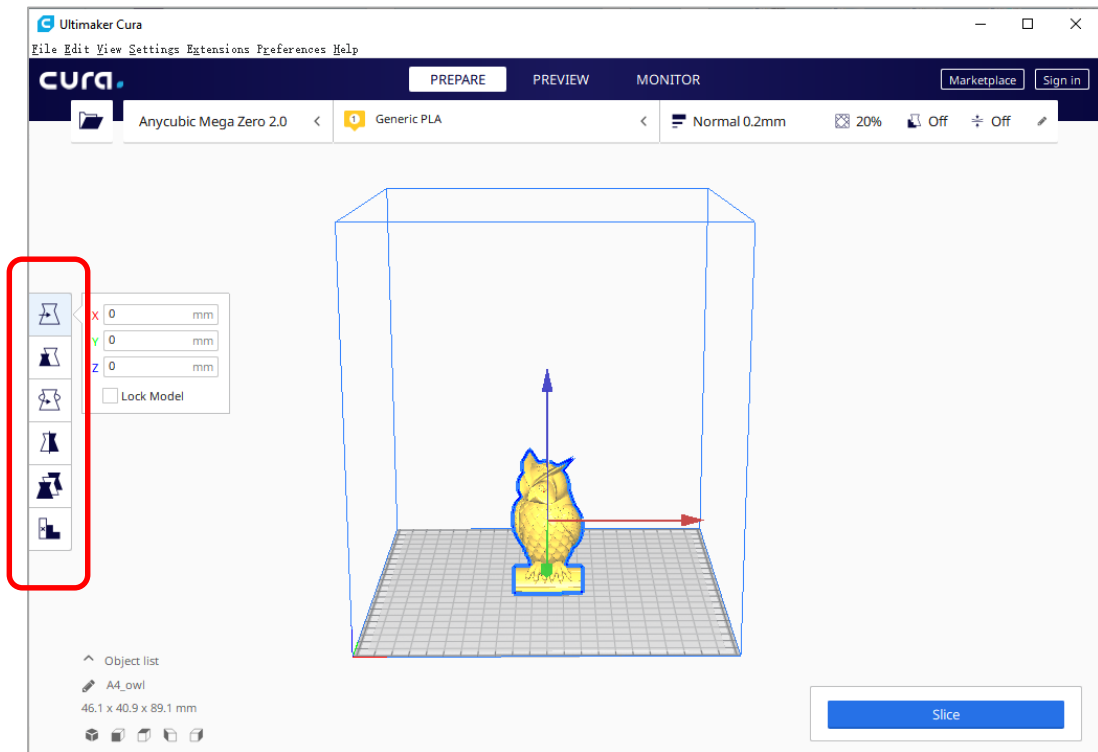

Other operations:

- Position change: left click on the model, hold on and drag the model to move.
- Zoom in/out: scroll the mouse wheel.
- Change viewing angle: right click and move the mouse.



Per Model Settings: When you open multiple models, you can edit a separate slicing configuration for the specified model.

Support Blocker(E): Set the mask area on the model so that the support could not be generated on the set area.

Introduction to slicing software

Note: as shown in the figure on the right, the gray color of the model indicates that the model is out of print range.

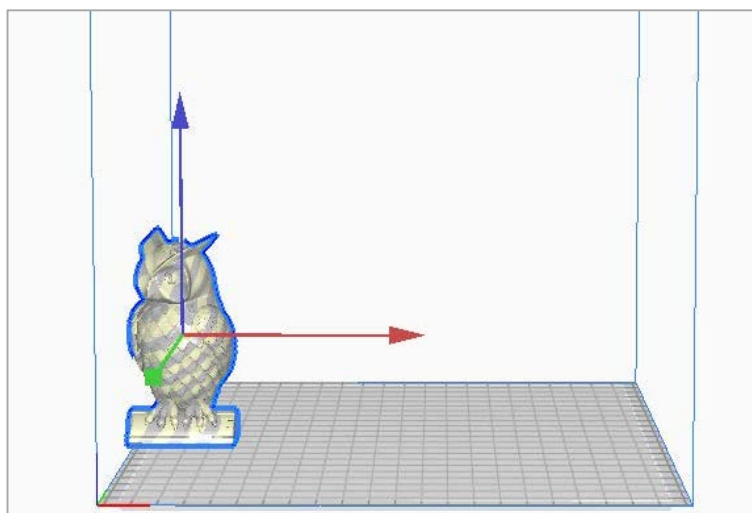

After importing the model, users can customize the printing parameters according to individual needs. But the configuration files that we provide are suggested.

Note: "Suggested parameters MEGA-ZERO 2.0-PLA. curaprofile" file is prepared for PLA filament, and "Suggested parameters MEGA-ZERO 2.0-TPU. curaprofile" file is prepared for TPU filament.

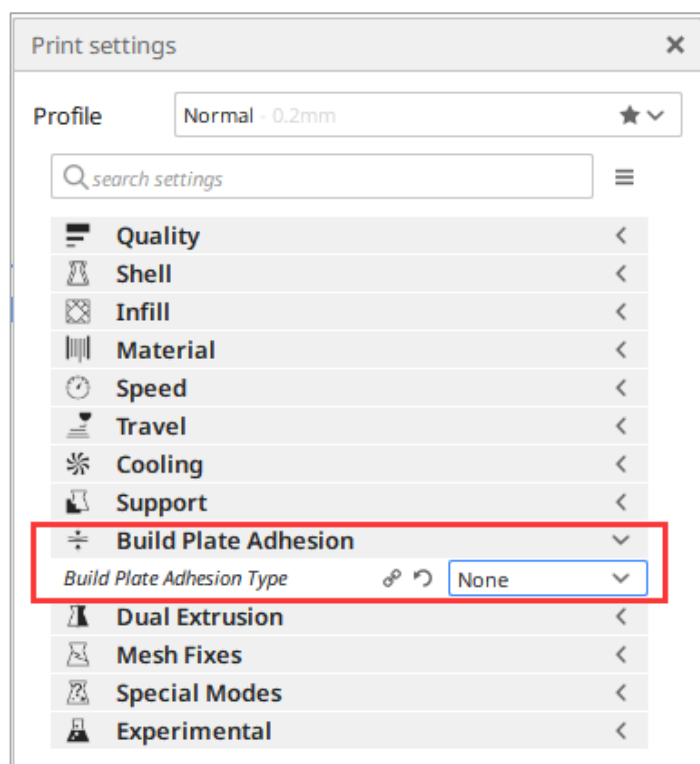

Note: The "Build Plate Adhesion Type" parameter needs to be set to "None" when you print the maximum size model.

Introduction to slicing software

5. Slice and preview

After setting the printing parameters, click the "Slice" button in the lower right corner of the software. After the slicing is finished, click the "preview" button to preview the simulated printing effect in the preview view.

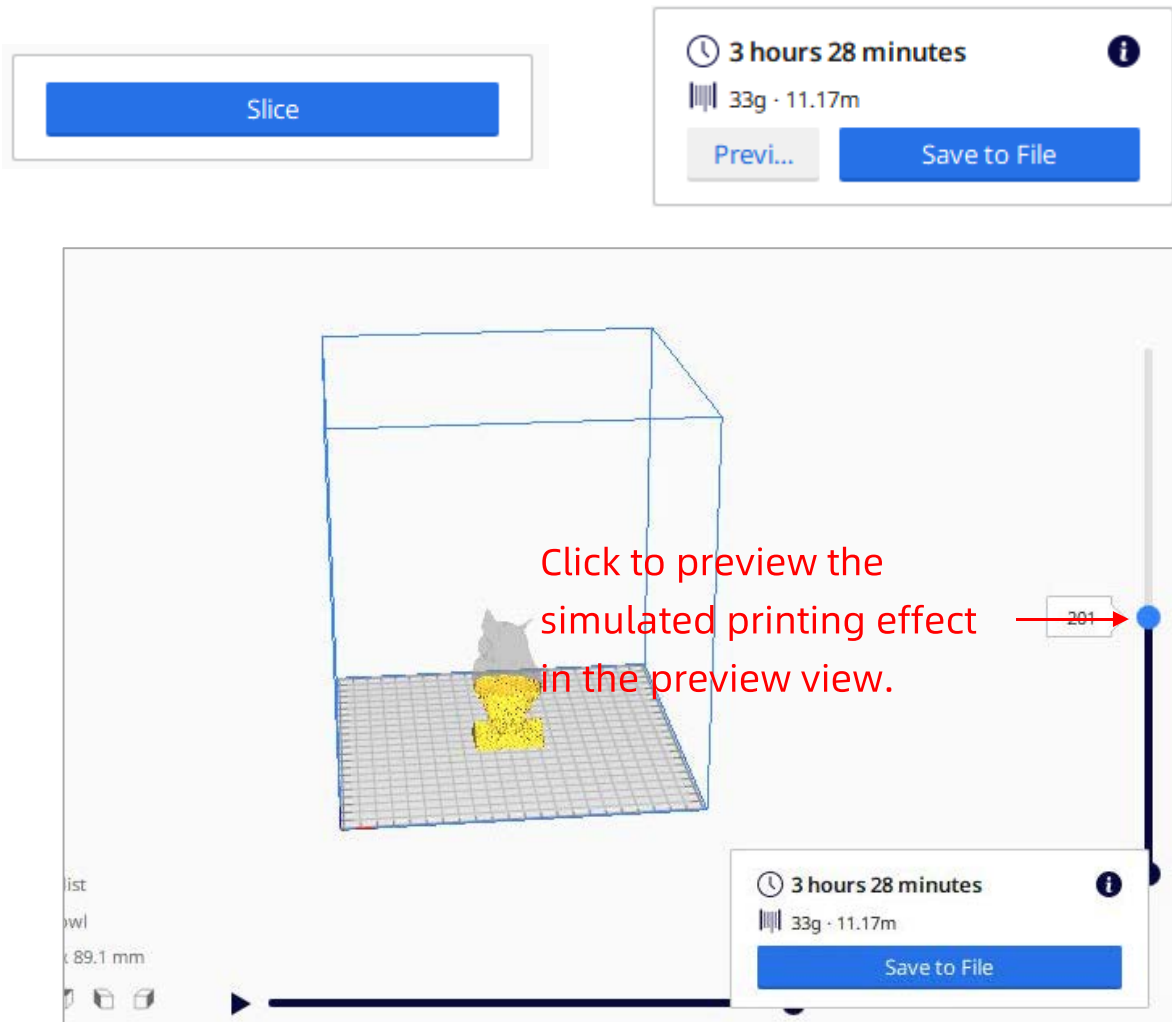

6. Print online

After the parameters have been set up, you can print online via Cura. Click the "MONITOR" on the main interface. If the printer is not connected properly, the interface will be blank.

Introduction to slicing software

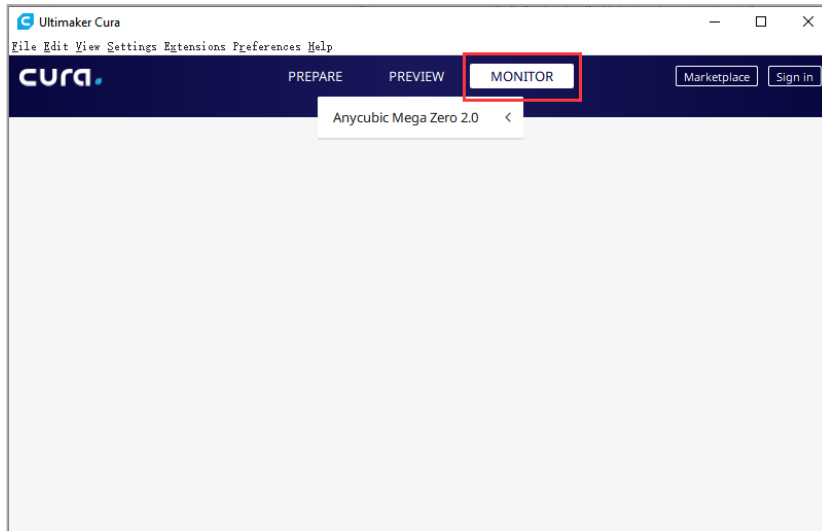

After connecting the data line, Cura will automatically connect to the printer. After waiting for more than ten seconds, the operation panel will be displayed on the right side of the interface. User can control printer through the operation panel. (In the process of printing, do not plug the data line, or it will interrupt the printing)

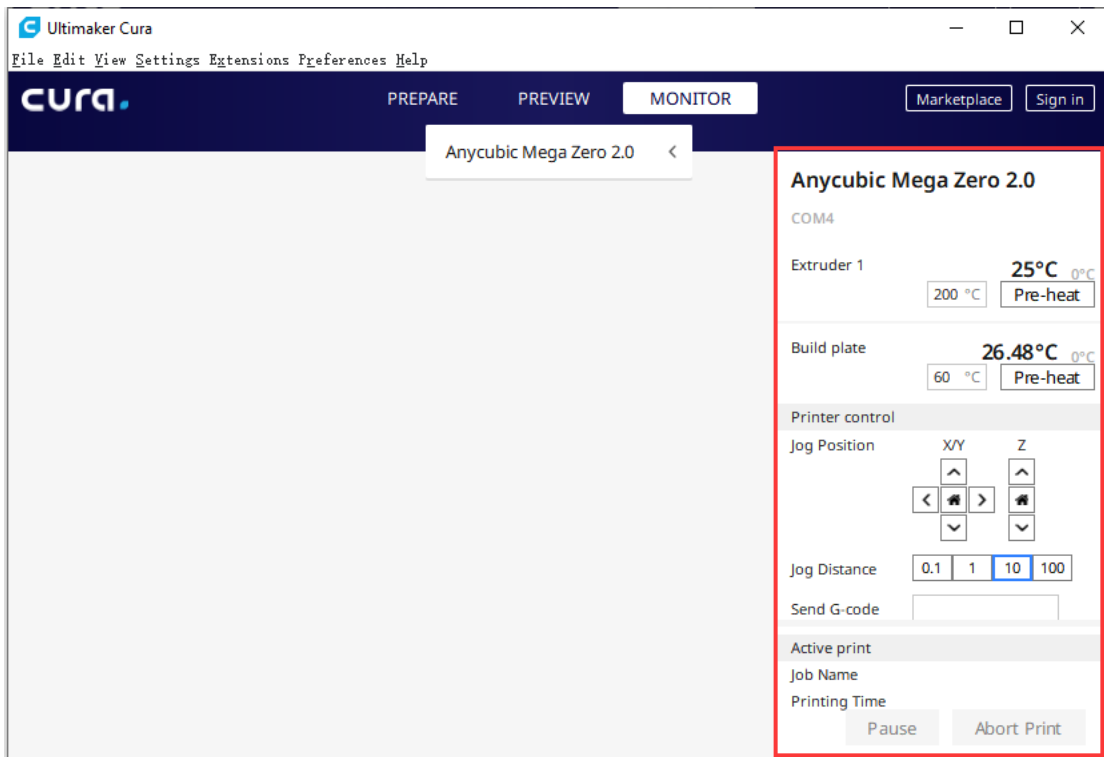

Introduction to slicing software

7. Print offline

After slicing, click "save to file" in the lower right corner of Cura software. Save the model GCode file to the **memory card**, and then insert the memory card to the printer and control via the touch screen for offline printing.

Note: The file name should only contain English letters, underscore and space. File name contains special characters could not be recognized by the printer. In order to let the printer better recognize the Gcode file in the memory card, you need to back up all the files in the memory card to the computer, and keep the memory card only for the Gcode file, please save all the Gcode files in root directory of the memory card.

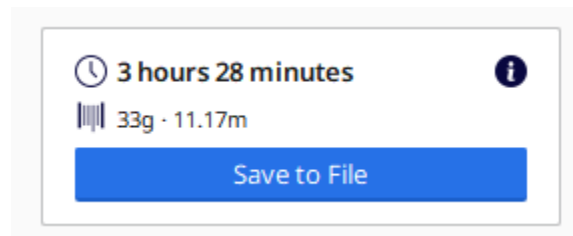

Resume from outage

During printing, if there is an accident power loss, the print will stop immediately. But after power comes back, customers could “Resume print” , machine will home first and continue on the unfinished object.

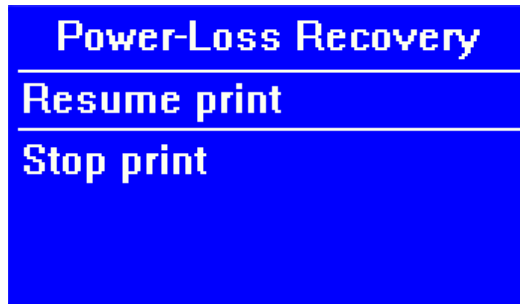

Note:

- ① “Resume from outage” is valid only for offline printing.
- ② In slicing software (i.e. Cura), it is required to place the model at the rear of the platform. Because during “RESUME”, machine will home first and could touch/interfere with the unfinished object if the model was placed in the front area.
- ③ In order to get smooth surface, use tweezers to carefully remove the excessive filament at nozzle before continuing printing upon the last point.
- ④ Do not move the model after power loss otherwise resume will be invalid.
- ⑤ This function is developed based on Cura. We could not guarantee this function compatible with other slicing software.
- ⑥ Due to the differences of models, filaments, temperature, extrusion settings, etc...we could not always guarantee a perfect surface finish at the point of “RESUME”, especially for small objects.

Maintenance

It is necessary to perform routine maintenance to the 3D printer to achieve consistent and quality results.

Some maintenance suggestions are shown as below:

1. Clean the nozzle with a needle under preheating conditions. If the filament residue in the nozzle could not be cleared 100%, please replace the nozzle.
2. Regularly add lubricating oil to smooth rods, linear bearings, lead screws, brass nuts, etc. It can minimize the wear-out failure of those moving parts.
3. Regularly clean the filament residue and dirt on the nozzle, platform, guide rail, motor, fan, etc.
4. Pay attention to the wear conditions of the D-shape wheels. Although they could be used for long time, please replace the D-shape wheels if they have been wore-out.
5. After finishing a printing, clean the printing platform to ensure the adhesion of the bottom layer of the model for next printing.
6. Check the belts regularly and tighten them if necessary.

Troubleshooting

1. Motor shaking or abnormal sound

- ① The corresponding limit switch could not be triggered when home. Check the wirings, and inspect all obstacles by manually moving the corresponding axis.
- ② The motor cable are not connected properly, check each connection and then inspect the cable routing for any fault.
- ③ The motor is damaged.

2. File not printing or memory card failure

- ① Remove the memory card and insert into PC. Open the GCode files using text editor (eg. Notepad), and inspect if GCode is readable or not. If files contains of multiple “ÿÿÿ” symbol, then file has been corrupted. Try to reformat the memory card to FAT32 format and to reload the GCode file.
- ② Memory card is not readable, ensure file name does not contain special characters or change memory card.
- ③ Display screen freeze, reboot the machine and try again.
- ④ The memory card is damaged.

3. The print head warms up too slowly and the temperature fluctuates greatly

- ① The print head is too close to the printing platform, and the cold air from the cooling fan is blown back to the heated aluminum block, which causes heat loss and temperature fluctuation. It is recommended to rise the print head before the print head heats up to ensure that there is a distance of more than 3cm between the print head and the platform.

Troubleshooting

4. No extrusion or extrusion motor knocking

- ① Filament tangles on spool.
- ② Teflon tubing has been tangled, squeezed or bent.
- ③ Ensure that the nozzle temperature has been set to match the filament.
- ④ Nozzle is clogged. Please try to replace it or clean it with a needle.
- ⑤ The hotend is not cooled enough.
- ⑥ Print speed is too fast, please reduce the print speed.
- ⑦ The friction between extruder and filament is not strong enough, please increase the extrusion force by rotating the adjustable nut of the extruder.

5. Filament leaking

- ① Nozzle, heating block or throat tube is not tightened properly, try to fix/change it after cooling.

6. Layer shifting

- ① Print head moves too fast, reduce the print speed.
- ② Check X/Y belt and the driving wheel and ensure they are properly installed.
- ③ The model is warping, please refer to item 7 below.
- ④ Drive current is too low, please contact our tech-support.

7. No sticking to the bed and the model is warping

- ① Check if the printing platform is properly leveled.
- ② Set "Initial Layer Height" to 0.2 and "Initial Layer Line Width" to 150 in Cura to improve initial layer adhesion.
- ③ Print too fast at the bottom layer speed, reduce it to ~20mm/s

Troubleshooting

8. Print head moves abnormal

- ① Check if choose the right machine type in slicing software.
- ② Check if any plugins in the slicing software.

9. Print stops halfway

- ① Use print offline mode (memory card) instead of print online via data cable.
- ② Check if the GCode file is corrupted.
- ③ Delete plugins in the GCode file.
- ④ Check if the memory card is damaged.
- ⑤ Power supply voltage is not stable, please print again when the voltage is stable.

10. The print model is difficult to be removed from the platform

- ① Preheat the bottom of the model by hot air and then shovel it with a scraper.
- ② The nozzle is too close to the platform, so the first layer of the model is very sticky with the platform. Make sure the distance between the nozzle and the platform is about the thickness of the paper(~0.1-0.2mm) when leveling, or increase the distance appropriately according to the viscosity of the material.
- ③ Reduce the width of the initial layer line.
- ④ The print speed of the initial layer is too slow, which will cause excessive stickiness between the model and the printing platform. Please increase the print speed of the initial layer.

Troubleshooting

11. The model looks normal but some parts cannot be printed

- ① Special parts such as overhanging parts need to be added with support, etc., and need to be adjusted according to the specific model. It is recommended to preview the print layer to see if it meets the requirements.

12. Drawing is more serious

- ① The retraction distance is insufficient. It should be set larger when slicing.
- ② The retraction speed is too slow. It should be set a bit faster when slicing.
- ③ The printing temperature is too high, which causes the fluidity and viscosity of the filament to be strong. The printing temperature needs to be set a little lower.

Thank you for purchasing **ANYCUBIC** products! Under normal usage and service, the products and its parts have a warranty period up to one year. Please visit **ANYCUBIC** official website (www.anycubic.com) for more details and report any issue with **ANYCUBIC** products. Our professional after-sale service team would respond within 24 hours and help you to solve the issues.