

HD 10/25-4 S

Upright cold water pressure washer. Servopress for adjustment of pressure and water flow rate directly on the trigger gun, pressure switch control, Easy-Press trigger gun with soft grip surface, pivoting stainless steel spray lance, detergent tank, separate compartment for nozzles.



Order no.

1.286-902.0

- Save energy and time: EASY!Force high-pressure guns and EASY!Lock quick-release locks.
- Water-cooled three-phase motor
- Maximum impact pressure for stubborn dirt

Technical data

EAN code		4054278158259
Current type	Ph / V / Hz	3 / 400 / 50
Flow Rate	l/h	500 - 1000
Water feed temperature	°C	60
Operating pressure	bar / MPa	30 - 250 / 3 - 25
Max. Pressure	bar / MPa	275 / 27.5
Power rating	kW	9.2
Weight (with accessories)	kg	68
Weight incl. packaging	kg	73.5
Dimensions (L × W × H)	mm	560 × 500 × 1090

Equipment

Trigger gun		EASY!Force Advanced
High-pressure hose	m	10
Spray lance	mm	1050
Power nozzle		■
4-pole three-phase motor with air and water cooling		■
Pressure switch control		■
Integrated fine mesh water filter		■
Electronic motor protection system with LED display		■
Oil sight glass		■
Servo Control		■
Brass water inlet fitting		■

■ Included in delivery.

This device requires instruction.



Save energy and time: EASY!Force high-pressure guns and EASY!Lock quick-release locks.

- At last - work without getting tired: the EASY!Force high-pressure gun.
- EASY!Lock quick-release locks: durable and robust. And five times faster than screws.

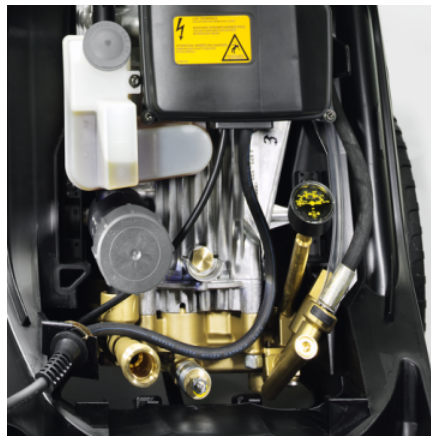

Proven Kärcher quality

- 4-pole water-cooled electric motor.
- Robust brass cylinder head and ceramic pistons.
- Reinforced, unbreakable plastic chassis.



For increased safety

- Integrated electronics for unit monitoring.
- Automatic switch-off in case of undervoltage or overvoltage.
- Switches off in case of leaks or phase failure.

EQUIPMENT FOR HD 10/25-4 S

1.286-902.0



		Order no.	Description	
TRIGGER GUNS				
Trigger guns				
EASY!Force Advanced	1	4.118-005.0	Effortless, not energy-sapping: the EASY!Force high-pressure gun uses the recoil force of the high-pressure jet to reduce the holding force for the operator to zero.	■
Conversion kit 1 from high pressure hose	2	4.111-050.0	A conversion kit which enables secure connection from an M22 hose onto our innovative EASY!Force trigger gun. The kit includes the EASY!Force Trigger gun, adaptors and lance.	□
Conversion kit 2 from device	3	4.111-051.0	Provides all the parts required to utilise our EASY!Force technology even on our non-Easy!Force machines. Including adaptors, lance, Easy!Force trigger gun and hose.	□
Conversion kit 3 only EASY!Force	4	4.111-052.0	A conversion kit for the EASY!Force gun, which includes the correct adaptors to connect to the M22 style lance and hose.	□
Servo Control				
Servo Control, 750 l/h - 1100 l/h	5	4.118-008.0	Water quantity and pressure regulated directly from the hand spray gun.	■
SPRAY LANCES				
Rotating spray lances				
Spray lance, 1050 mm, rotatable	6	4.112-000.0	1050 mm stainless steel lance (manual coupling) with ergonomic handle for ease of use and protection. Rotatable 360° under pressure.	■
LED nozzle light	7	2.680-002.0	LED work light for assembly on EASY!Force spray lances, providing a clear view in poor lighting conditions ensuring controlled cleaning results.	□
Spray lance, 250 mm, rotatable	8	4.112-027.0	250 mm stainless steel lance (manual coupling) with ergonomic handle for ease of use and protection. Rotatable 360° under pressure.	□
Spray lance, 400 mm, rotatable	9	4.112-024.0	400 mm stainless steel lance (manual coupling) with ergonomic handle for ease of use and protection. Rotatable 360° under pressure.	□
Spray lance, 600 mm, rotatable	10	4.112-007.0	600 mm stainless steel lance (manual coupling) with ergonomic handle for ease of use and protection. Rotatable 360° under pressure.	□
Spray lance, 840 mm, rotatable	11	4.112-006.0	850 mm stainless steel lance (manual coupling) with ergonomic handle for ease of use and protection. Rotatable 360° under pressure.	□
Spray lance, 1550 mm, rotatable	12	4.112-018.0	1550 mm stainless steel lance (manual coupling) with ergonomic handle for ease of use and protection. Rotatable 360° under pressure.	□
Spray lance, 2050 mm, rotatable	13	4.112-021.0	2050 mm stainless steel lance (manual coupling) with ergonomic handle for ease of use and protection. Rotatable 360° under pressure.	□
Spray lance extender, 1000 mm	14	4.112-048.0	Spray lance extension with EASY!Lock connection. Length 1000 mm.	□

■ Included in delivery. □ Available accessories.

EQUIPMENT FOR HD 10/25-4 S

1.286-902.0



		Order no.	Description	
SPRAY LANCES				
Double lance				
Double lance, 960 mm	15	2.112-016.0	960 mm double lance for variable pressure adjustment on handle at full water flow rate. Suitable for agricultural use (e.g. stable cleaning).	<input type="checkbox"/>
Angular spray lance				
WC and gutter lance	16	4.112-029.0	Stainless steel lance WC and gutter with nozzle insert. Specially shaped for effective and hygienic cleaning of gutters and toilets.	<input type="checkbox"/>
Flexible spray lance				
Flexible lance, 1050 mm	17	4.112-035.0	1050 mm flexible lance with variable bend from 20° to 140°, ideal for cleaning difficult to reach areas, e.g. gutters.	<input type="checkbox"/>
High pressure articulated joint	18	4.112-057.0	For hard-to-reach areas: High-pressure articulated joint with infinite angle adjustment up to 120°. Simply attach directly to the spray lance of the pressure washer.	<input type="checkbox"/>
Gutter cleaner				
Gutter cleaning lance	19	2.112-015.0	The lance is suited for cleaning of gutter systems. Because of the shape of the lance and the special nozzle the gutter can be cleaned without removing the cover plates.	<input type="checkbox"/>
Undercarriage spray lance				
Underbody lance	20	4.112-032.0	Stainless steel lance for effective and easy underbody and wheel arch cleaning. Without high-pressure nozzle.	<input type="checkbox"/>
Additional handle				
Additional handle for EASY!Lock spray lances	21	4.321-380.0	Comfortable in every situation - the additional handle is easy to attach to the spray lance of our new EASY!Lock generation and makes work easier by allowing you to adjust your posture to suit the particular task.	<input type="checkbox"/>
KÄRCHER POWER NOZZLE				
Power nozzle spray angle 25°				
Power Nozzle 25°, 047	22	2.113-009.0	Fan jet nozzle with 25° spray angle, suitable for large areas and removing stubborn dirt and stains.	<input checked="" type="checkbox"/>
HP nozzle spray angle 0°				
Power Nozzle 0°, 050	23	2.113-034.0	High-pressure nozzle with powerful jet for extremely stubborn dirt.	<input type="checkbox"/>
Power nozzle spray angle 15°				
Power Nozzle 15°, 055	24	2.113-047.0	Fan jet nozzle with 15° spray angle suitable for stubborn dirt.	<input type="checkbox"/>
Power nozzle spray angle 40°				
Power Nozzle 40°, 050	25	2.113-054.0	Power nozzle with a 40° spray angle and fan jet, suitable for large areas and sensitive surfaces.	<input type="checkbox"/>
HIGH-PRESSURE HOSES				
Standard with unions on both sides				
High-pressure hose, 10 m, 315 bar, 2 × EASY!Lock	26	6.110-031.0	10 m high-pressure hose (M 22 × 1.5) with kink protection. With patented rotating AVS trigger gun connector and manual coupling. Further data: DN 8/155°C/315 bar.	<input checked="" type="checkbox"/>
High-pressure hose, 15 m, 315 bar, 2 × EASY!Lock	27	6.110-030.0	15 m high-pressure hose (M 22 × 1.5) with kink protection. With patented rotating AVS trigger gun connector and manual coupling. Further data: DN 8/155°C/315 bar.	<input type="checkbox"/>
High-pressure hose, 20 m, 315 bar, 2 × EASY!Lock	28	6.110-032.0	20 m high-pressure hose (M 22 × 1.5) with kink protection. With patented rotating AVS trigger gun connector and manual coupling. Further data: DN 8/155°C/315 bar.	<input type="checkbox"/>

■ Included in delivery. □ Available accessories.

EQUIPMENT FOR HD 10/25-4 S 1.286-902.0

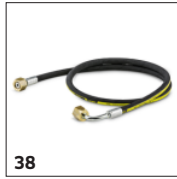

	Order no.	Description	
HIGH-PRESSURE HOSES			
Standard with unions on both sides			
High-pressure hose, 30 m, 315 bar, 2 x EASY!Lock	29	6.110-014.0 With rotary coupling, 2 x M 22 x 1.5	<input type="checkbox"/>
High-pressure hose, 15 m, 220 bar, 2 x EASY!Lock	30	6.110-042.0 15 m high-pressure hose M 22 x 1.5) with kink protection and threaded couplings at both ends. Further data: DN 10/155°C/220 bar.	<input type="checkbox"/>
High-pressure hose, 20 m, 220 bar, 2 x EASY!Lock	31	6.110-043.0 with union on both sides, M 22 x 1.5 with anti-kink protection. NW 10/155°C/220 bar	<input type="checkbox"/>
High-pressure hose, 25 m, 220 bar, 2 x EASY!Lock	32	6.110-044.0	<input type="checkbox"/>
High-pressure hose, 40 m, 220 bar, 2 x EASY!Lock	33	6.110-045.0	<input type="checkbox"/>
High-pressure hose, 15 m, 210 bar, 2 x EASY!Lock	34	6.110-059.0 High-pressure hose for water volumes greater than 1,800 l / h. With union on both sides. 2x M 22 x 1.5 with anti-kink protection.	<input type="checkbox"/>
High-pressure hose, 40 m, 210 bar, 2 x EASY!Lock	35	6.110-060.0	<input type="checkbox"/>
High-pressure hose, 10 m, 220 bar, 2 x EASY!Lock	36	6.110-041.0	<input type="checkbox"/>
Longlife 400 with unions on both sides			
High-pressure hose Longlife, 1.5 m, 400 bar, 2 x EASY!Lock	37	6.110-024.0 1.5 m high-pressure hose (DN 8, M 22 x 1.5) with kink protection and connectors at both ends. For connecting to hose reels with appropriate connector (M 22 x 1.5).	<input type="checkbox"/>
High-pressure hose Longlife, 1.5 m, 400 bar, 1 x EASY!Lock / 1 x M22 x 1.5	38	6.110-069.0 High-pressure hose (ID 8) with double steel reinforcement, 1.5 m long, suitable for up to 400 bar pressure. Connectors: M 22 x 1.5, quick and convenient EASY!Lock hand screw connection.	<input type="checkbox"/>
High-pressure hose Longlife, 10 m, 400 bar, 2 x EASY!Lock	39	6.110-038.0 Durable, 10 m long high-pressure hose (ID 8) with double steel reinforcement and EASY!Lock hand screw connection at both ends and ANTI!Twist. Approved for 400 bar pressure.	<input type="checkbox"/>
High-pressure hose Longlife, 30 m, 400 bar, 2 x EASY!Lock	40	6.110-023.0 With rotary coupling, 2 x M 22 x 1.5	<input type="checkbox"/>
High-pressure hose Longlife, 20 m, 400 bar, 2 x EASY!Lock	41	6.110-027.0 with rotary coupling, 2 x M 22 x 1.5	<input type="checkbox"/>
High-pressure hose Longlife, 15 m, 400 bar, 2 x EASY!Lock	42	6.110-029.0 With rotary coupling, 2 x M 22 x 1.5	<input type="checkbox"/>

■ Included in delivery. □ Available accessories.

EQUIPMENT FOR HD 10/25-4 S 1.286-902.0

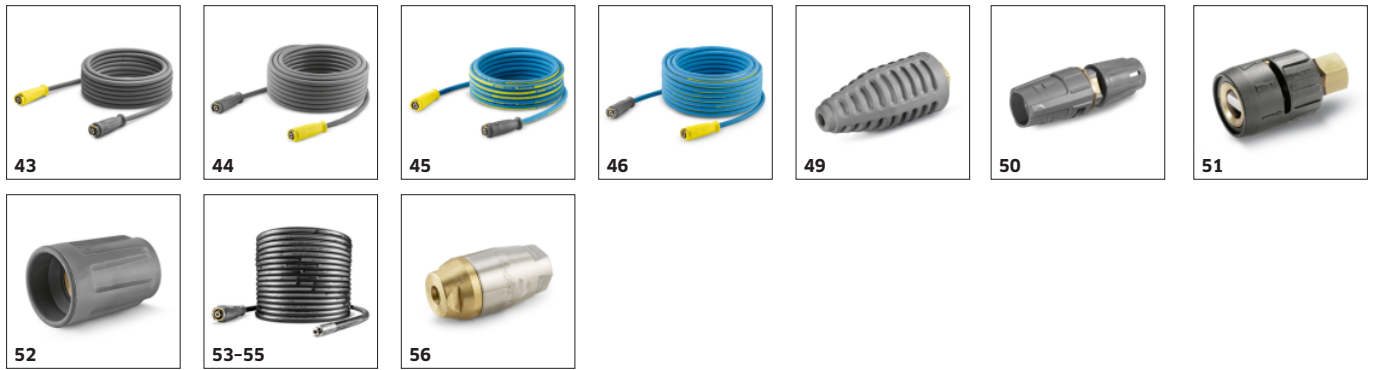

		Order no.	Description	
HIGH-PRESSURE HOSES				
Food industry version with unions on both sides				
High-pressure hose food grade, 10 m, 250 bar, 2 × EASY!Lock	43	6.110-051.0	10 m high-pressure hose (DN 8) with patented (rotating) AVS trigger gun connector. Non-discolouring outer layer for use in the food industry. M 22 × 1.5 with anti-kink sleeve.	<input type="checkbox"/>
High-pressure hose food grade, 20 m, 250 bar, 2 × EASY!Lock	44	6.110-052.0	20 m high-pressure hose (DN 8) with swivel coupling. Non-discolouring outer layer for use in the food industry. Connectors at both ends, M 22 × 1.5, with kink protection. NW 8/155°C/250 bar.	<input type="checkbox"/>
Longlife food industry version with unions on both sides				
High-pressure hose food grade Longlife, 10 m, 400 bar, 2 × EASY!Lock	45	6.110-053.0	Longlife HP hose for use in the food industry. Außendecke## animal-grease-resistant, non-colour-bleeding material. With rotary coupling, 2 × M 22 × 1,5	<input type="checkbox"/>
High-pressure hose food grade Longlife, 20 m, 400 bar, 2 × EASY!Lock	46	6.110-054.0	Longlife HP hose for use in the food industry. Außendecke## animal-grease-resistant, non-colour-bleeding material. With patented AVS connection in the pistol (pivot mounted)	<input type="checkbox"/>
INTERIOR CLEANING HEADS				
HKF 50				
HKF 50 P	47	3.631-008.0	Spray head driven by a compressed air motor for the industrial container cleaning Cleaning of small barrels (200 - 500 l)	<input type="checkbox"/>
Spray head HKF 50, stainless steel	48	3.631-009.0		<input type="checkbox"/>
ROTARY NOZZLES (DIRT BLASTERS)				
Dirt blaster, large				
Dirt Blaster Nozzle, large, 050	49	4.114-027.0	The dirt blaster with rotating pencil jet offers 10 times better cleaning performance. Ceramic nozzle and bearing ring for a long service life. Further data: Max. 300 bar, 30 MPa, 85°C.	<input type="checkbox"/>
MULTIPLE-JET NOZZLES				
Triple nozzles				
Triple Nozzle, 050	50	4.117-037.0	Triple nozzle with manual nozzle changeover. Convenient spray adjustment. For high-pressure cleaners with injector; low-pressure fan jet for detergent removal and application.	<input type="checkbox"/>
Angle vario nozzle 0°-90°				
Angled Vario Nozzle, 050	51	4.113-007.0	Variable angle nozzle for spray angle adjustment from 0° to 90°. For easy adjustment to all kinds of soiling and surfaces.	<input type="checkbox"/>
NOZZLE UNION / SPACER				
Nozzle union				
Nozzle screws	52	4.112-011.0	Nozzle screws with protectors for high-pressure and power nozzles	<input type="checkbox"/>
PIPE CLEANING				
Pipe cleaning hose, ID 6				
Hose assembly TR pipe cleaning DN6 max.2	53	6.110-046.0	The 10 m pipe cleaning hose is a highly flexible high pressure hose for pipe interior cleaning (threaded connection for nozzle R 1/8).	<input type="checkbox"/>
Pipe cleaning hose, DN 6, 20 m, 220 bar	54	6.110-008.0	20 m flexible high-pressure hose (DN 6) for cleaning pipes up to 220 bar (threaded connection for R 1/8 nozzle).	<input type="checkbox"/>
Hose assembly TR pipe cleaning DN6 max.2	55	6.110-047.0	The 30 m pipe cleaning hose is a highly flexible high pressure hose for pipe interior cleaning (threaded connection for nozzle R 1/8).	<input type="checkbox"/>
Pipe cleaning nozzle				
Dirt blaster pipe cleaning D21/060	56	4.765-002.0	The forward-tilted rotating pencil jet removes the most stubborn dirt. The three backwards-tilted jets ensure the necessary forward movement, as well as convenient handling.	<input type="checkbox"/>

Available accessories.

EQUIPMENT FOR HD 10/25-4 S 1.286-902.0



	Order no.	Description	
PIPE CLEANING			
Pipe cleaning nozzle			
Dirt blaster pipe cleaning D30/060	57 4.765-005.0	The forward-tilted rotating pencil jet removes the most stubborn dirt. The three backwards-tilted jets ensure the necessary forward movement, as well as convenient handling.	<input type="checkbox"/>
Nozzle pipe cleaning size 80	58 5.763-087.0	Pipe cleaning nozzle with 24 mm diameter. With 4 nozzles tilted back at a 30° angle.	<input type="checkbox"/>
Pipe cleaning nozzle	59 5.763-019.0	16 mm pipe cleaning nozzle with internal thread. Various jet directions for environmentally-friendly cleaning of blocked drains and pipes.	<input type="checkbox"/>
	60 5.763-016.0		<input type="checkbox"/>
	61 5.763-021.0	30 mm pipe cleaning nozzle with internal thread. Various jet directions for environmentally-friendly cleaning of blocked drains and pipes.	<input type="checkbox"/>
Rotating pipe cleaning nozzle	62 6.415-440.0	Rotating pipe cleaning nozzle with internal thread and four rotating jets for environmentally-friendly cleaning of blocked drains and pipes.	<input type="checkbox"/>
FLOOR AND HARD SURFACE CLEANER			
Hard Surface Cleaner FRV 30			
Add-on kit rubber lip	63 2.642-910.0	For smooth floors indoors. The squeegee increases the suction performance of the FRV 30 and minimises the amount of water remaining. This means the floor is dry in just a few minutes.	<input type="checkbox"/>
Extension hose 5 m	64 4.440-939.0	5m extension hose for FRV 30. Connection sleeve included.	<input type="checkbox"/>
Add-on kit hose attachment	65 2.642-528.0	Suction cup for fixing the suction hose to smooth surfaces.	<input type="checkbox"/>
Add-on kit dirt trap	66 2.642-532.0	Galvanised steel bucket for collecting coarse dirt and for fixing the suction hose in outside areas.	<input type="checkbox"/>
FRV 30	67 2.111-010.0	Surface cleaner with integrated waste water pick-up	<input type="checkbox"/>
Hard surface cleaner FR 30 ME			
FR 30 ME surface cleaner	68 2.111-013.0	Hot water resistant stainless steel surface cleaner with double ceramic bearings, non-marking swivel castors and suction hose connection. Ideal for indoor cleaning, e.g. food industry.	<input type="checkbox"/>
Hard Surface Cleaner FR 50			
FR 50 surface cleaner	69 2.111-023.0	Hot water resistant stainless steel surface cleaner with 500 mm working width. Ideal for large areas. With double ceramic bearings, push handle, non-marking swivel castors and detergent dosing system.	<input type="checkbox"/>
Machine-specific nozzle kit for FR			
Nozzle kit for FR, 850 l/h - 1100 l/h	70 2.640-442.0	Nozzle kit includes power nozzles and unions. For Kärcher surface cleaners (850 to 1100 l/h).	<input type="checkbox"/>

Available accessories.

EQUIPMENT FOR HD 10/25-4 S 1.286-902.0



		Order no.	Description	
FLOOR AND HARD SURFACE CLEANER				
Machine-specific nozzle kits for FRV				
Nozzle kit for FRV, 050	71	2.642-433.0	Machine-specific nozzle kit with Kärcher power nozzles and jet nozzle for FRV 30.	<input type="checkbox"/>
Hard surface cleaner FRV 30 Me				
Extension hose FRV 30 Me and FRV 50 Me	72	4.441-040.0	5 m extension hose for FRV 30 Me. Includes connecting adapter.	<input type="checkbox"/>
FRV 30 Me Surface Cleaner	73	2.111-012.0	Thanks to automatic suction of the dirty water, the stainless steel FRV 30 Me Surface Cleaner makes surface cleaning more efficient in both inside and outside areas. Hot water cleaning up to 85°C.	<input type="checkbox"/>
Surface Cleaner FR 50 Me				
FRV 50 Me surface cleaner	74	2.111-024.0	Surface cleaning with automatic suction of the dirty water for very large surfaces. Hot water cleaning up to 85°C.	<input type="checkbox"/>
FOAM SYSTEMS				
Cup foam lance				
Cup foam lance Basic 3, 900 l/h - 2500 l/h	75	4.112-055.0	For high-pressure cleaners with a flow rate of 900-2500 l/h: new, robust and very high-quality foam cup lance with outstanding foam quality while consuming half as much cleaning agent.	<input type="checkbox"/>
1-litre cleaning agent container for cup foam lance basic	76	5.071-414.0		<input type="checkbox"/>
1-litre cleaning agent container for cup foam lance advanced	77	6.414-050.0	Additional 1-litre cleaning agent container for quick replacement of the cleaning agent (for foam lance 2.112-017.0 and 2.112-018.0).	<input type="checkbox"/>
Cup foam lance Advanced 3, 900 l/h - 2500 l/h	78	4.112-065.0		<input type="checkbox"/>
Cup foam lance DUO Advanced 3, 900 l/h - 2500 l/h	79	4.112-069.0		<input type="checkbox"/>
Inno Foam Set				
Inno foam kit with detergent injector	80	2.112-000.0	High-pressure foam system with double lance (foam nozzle and high-pressure jet for rinsing). For use with mobile and stationary high-pressure and HDS pressure cleaners for cleaning or disinfection.	<input type="checkbox"/>
Easy Foam Set				
Easy Foam Set with RM injector	81	2.112-010.0	HP foam system for use with HD/HDS units for cleaning and disinfecting. Foam nozzle for connection to lance and HP chemical injector with precision 0-5% metering valve. The machine specific nozzle kit has to be ordered separately.	<input type="checkbox"/>
Nozzle kits for Inno/Easy Foam Set				
Nozzle kit 090 Inno/Easy kit 700 - 1000 l/h	82	2.111-019.0	Nozzle kit contains Kärcher power nozzles and nozzle inserts. For Inno/Easy-Foam set 700-1000 l/h. For optimal foam system performance.	<input type="checkbox"/>
Foam nozzle mounting kit				
Foam nozzle kit	83	2.112-013.0	Foaming agent kit. The foam nozzle is ideal for use in sanitary areas and the food industry and wherever long application times are necessary.	<input type="checkbox"/>
MIXERS AND INJECTORS				
HP detergent injector				
Stainless steel injector kit for HD 10/25-4S	84	6.645-761.0	Stainless steel injector for cleaning agent and foam applications. Specifically for the HD 10/25-4 S High-pressure cleaner. For precise cleaning agent dosage.	<input type="checkbox"/>

Available accessories.

EQUIPMENT FOR HD 10/25-4 S 1.286-902.0



		Order no.	Description	
MIXERS AND INJECTORS				
HP detergent injector				
Detergent injector for high and low pressure (without nozzles)	85	4.637-032.0	Detergent injector for independent high and low pressure dosage. Maximum dosage about 15%.	<input type="checkbox"/>
Detergent injector for high pressure	86	4.637-033.0	Cleaning agent dosage at high pressure 3 - 5 %	<input type="checkbox"/>
Machine-specific nozzle kit with order no. 3.637-170				
Nozzle insert trapezoidal thread HDS-GER	87	4.769-011.0	For HD/HDS 750 - 1000 l/h. Consists of nozzle insert + HP power nozzle + union	<input type="checkbox"/>
Nozzle insert with order no. 3.637-001				
Nozzle insert for Order No. 3.637-001, high-pressure for machines up to 1100 l/h.	88	4.769-003.0	Nozzle insert for detergent injector 3.637-001 for high-pressure detergent application. For high-pressure cleaners with a water flow rate up to 1100 l/h.	<input type="checkbox"/>
Low pressure for units rated up to 1100 l/h	89	4.769-001.0	For low pressure with machines up to 1.100 l/h	<input type="checkbox"/>
QUICK CONNECT				
Quick-fitting pipe union coupler trapezo	90	2.115-000.0	For fast changes between different spray lances/accessories. Perfect for Kärcher spray unit, suitable for trigger gun/spray lance interface. With M 22 × 1.5 internal thread.	<input type="checkbox"/>
Quick-fitting pipe union plug nipple tra	91	2.115-001.0	Hardened stainless steel male coupling for quick coupling 2.115-000. With M 22 × 1.5 external thread.	<input type="checkbox"/>
DRUM AND TANK CLEANING				
Add-on kit mud sucker	92	2.641-798.0		<input type="checkbox"/>
OTHER HP ACCESSORIES				
Jet gun	93	2.869-067.0	Short set-up time, easy transport, instant switch off - the jet gun is the affordable cleaning method for all kinds of small to medium-sized areas. Adjustable pressure/water volume.	<input type="checkbox"/>
COUPLING PARTS				
Rotary coupling				
Rotary coupling	94	4.111-021.0	Kärcher rotary coupling prevents twisting and kinking of high-pressure hoses for ease of use. Connector Easy!Lock. With grip protection.	<input type="checkbox"/>
Connector				
Nozzle connector/screw connector	95	4.111-022.0	Nozzle connector/screw connector for connecting high-pressure nozzles and accessories to the high-pressure trigger gun (with nozzle connector). Connectors: 1x M 22 × 1.5 and 1x M 18 × 1.5.	<input type="checkbox"/>
Y distributor	96	4.111-024.0	Offers the option to connect two spray units to the machine. Installation on the high pressure outlet.	<input type="checkbox"/>
Short spray unit	97	4.111-038.0	For attaching high-pressure nozzles and accessory parts to HP trigger gun (with nozzle screws). Not compatible with triple nozzles.	<input type="checkbox"/>
Adapter EASY!Lock				
Adapter 1 M22AG-TR22AG	98	4.111-029.0	Adapter 1 to connect the old hose with the new hose	<input type="checkbox"/>

Available accessories.

EQUIPMENT FOR HD 10/25-4 S 1.286-902.0



		Order no.	Description	
COUPLING PARTS				
Adapter EASY!Lock				
Adapter 2 M22IG-TR22AG	99	4.111-030.0	Adapter 2 to connect the old device with the new hose and the old gun with the new hose	<input type="checkbox"/>
Adapter 3 M22IG-TR22AG	100	4.111-031.0	Adapter 3 to connect the old gun with the new spray lance and new servo regulator	<input type="checkbox"/>
Adapter M22 - Swivel	101	4.111-032.0	M22 × 1,5female and swivel connection. For extension of high-pressure hoses with AVS connection or for usage of the telescopic lance with a high-pressure hose with AVS connection.	<input type="checkbox"/>
Adapter 5 TR22IG-M22AG	102	4.111-033.0	Adapter 5 to connect the new gun with the old spray lance and new servo regulator with the old spray lance	<input type="checkbox"/>
Adapter 6 TR22IG-M22AG	103	4.111-034.0	Adapter 6 to connect the new device with the old hose and the old hose with the new gun	<input type="checkbox"/>
Adapter 7 M18IG-TR20AG	104	4.111-035.0	Adapter 7 to connect the old spray lance with the new nozzle	<input type="checkbox"/>
Adapter 8 TR20IG-M18AG	105	4.111-036.0	Adapter 8 to connect the new spray lance with the old nozzle	<input type="checkbox"/>
Coupler -2xM22x1,5	106	4.111-037.0	Brass double connector for connecting and extending high-pressure hoses. With rubber protection. Connector: 2x M 22 × 1.5 m.	<input type="checkbox"/>
ADAPTER for replacement TR22IG-M22AG Er	107	4.111-046.0	Rotatable adapter for connecting EASY!Force high-pressure gun and high-pressure hoses with M 22x1.5 connection	<input type="checkbox"/>
HOSE REELS				
Hose reel add-on kit				
Hose reel attachment kit for HD super class, 20 m	108	2.110-008.0	ABS hose reel for mounting on the machine. For safe and tidy stowage of high-pressure hoses. Can be rotated under pressure, with M 22 × 1.5 connection.	<input type="checkbox"/>
Automatic, self-winding hose reels				
Automatic plastic hose reel incl. high-pressure hose, 15 m	109	2.639-257.0		<input type="checkbox"/>
Automatic hose reel, powder-coated steel / plastic, 20 m	110	6.392-074.0	Automatic hose reel for 20 m high-pressure hose. The console is made from powder-coated steel, the drum is made from plastic.	<input type="checkbox"/>
Automatic stainless steel / synthetic material hose drum, 20 m	111	6.392-083.0	Automatic hose reel for 20 m high-pressure hose. The console consists of stainless steel, the drum is made from plastic.	<input type="checkbox"/>
Automatic hose reel, coated, 20 m	112	6.392-106.0	Automatic hose reel of durable plastic. Painted steel bracket. Suitable for 20 m high-pressure hose.	<input type="checkbox"/>

Available accessories.

EQUIPMENT FOR HD 10/25-4 S 1.286-902.0

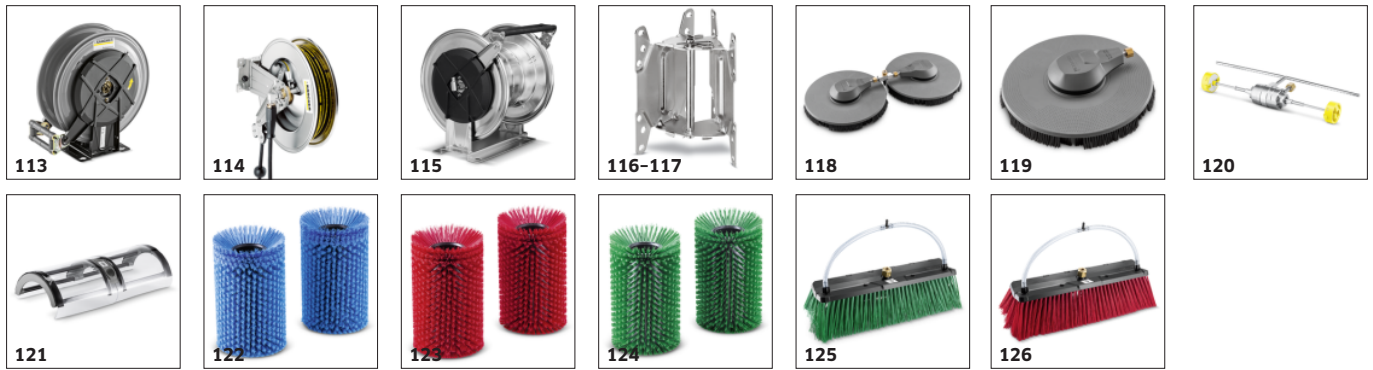

	Order no.	Description	
HOSE REELS			
Automatic, self-winding hose reels			
Hose reel, automatic, basalt grey-coated, 20 m	113	6.392-105.0	Automatic hose reels provide the highest level of safety and convenience for winding and unwinding HP hoses. <input type="checkbox"/>
Automatic hose reel, stainless steel, includes swivel holder, 20 m	114	6.392-076.0	Automatic stainless steel hose reel. With swivel holder. Suitable for 20 m high-pressure hose. <input type="checkbox"/>
Automatic stainless steel hose reel, 40 m	115	6.392-442.0	Automatic hose reels provide the highest level of safety and convenience for winding and unwinding HP hoses. Compatible high-pressure hose, e.g. order no. 6.110-076.0 (ID 8, 40 m, 400 bar, 1x hose reel connection attachment kit). <input type="checkbox"/>
Powder-coated swivel holder	116	2.639-931.0	Swivel holder for automatic hose reel wall mounting. For maximum action radius and flexibility of high-pressure hose. Rotatable 120°. Galvanised steel. <input type="checkbox"/>
Stainless steel swivel holder	117	2.641-867.0	Swivelling wall bracket made of high-grade steel (for 2.641-866). This makes maximum flexibility and convenience possible when working with the HP hose. <input type="checkbox"/>
FACADE AND SOLAR PANEL CLEANING			
Brushes			
iSolar 800 Advanced	118	6.368-094.0	iSolar 800 water-driven brush head, 800 mm wide, for water flow rates of 700-1,000 l/h. With two contra-rotating disc brushes and flexible angle joint. For photovoltaic systems. <input type="checkbox"/>
iSolar 400 Advanced	119	6.368-092.0	iSolar 400 brush for water flow rate of 700-1,000 l/h. The water-driven disc brush with a width of 400 mm cleans small to medium-sized photovoltaic systems. Also perfect for use on elevated systems. <input type="checkbox"/>
Drive for roller brush 500	120	4.762-584.0	Hydraulic drive for rotating roller brushes. For cleaning façades or solar power installations with our professional high-pressure cleaners. Installation on spray lance or telescopic lance. <input type="checkbox"/>
Splash guard for roller brush 500	121	4.762-621.0	Splash guard with velcro fastening for rotating roller brush. Clear view of the brush thanks to transparent film, with protection against splashes at the same time. <input type="checkbox"/>
Roller brush 500 soft	122	4.762-623.0	Soft brush attachment for use with hydraulic drive (4.762-584.0). Ideal for glass and solar power installation cleaning. Easy quick-change system and secure mounting on drive. <input type="checkbox"/>
Roller brush 500 medium	123	4.762-624.0	Medium-hard brush attachment for use with hydraulic drive (4.762-584.0). Suitable for sensitive façades, foils and fabrics. Easy and safe quick-change system. <input type="checkbox"/>
Roller brush 500 hard	124	4.762-625.0	Hard brush attachment for use with hydraulic drive (4.762-584.0). For rough façades, stone and wooden patios. Safe and easy quick-change system. <input type="checkbox"/>
Brush hard	125	6.960-133.0	Brush with hard bristles for cleaning industry façades and floor coverings and removing coarse dirt. Simple installation on telescopic lances or high-pressure lances from Kärcher. <input type="checkbox"/>
Brush medium	126	6.960-134.0	Optimally cleans façades, roller shutters and textile fabrics: the brush with medium-hard bristles for fast and simple attachment to telescopic lances or high-pressure lances from Kärcher. <input type="checkbox"/>

Available accessories.

EQUIPMENT FOR HD 10/25-4 S

1.286-902.0



127



128

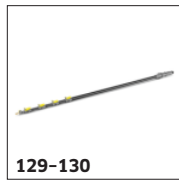

129-130

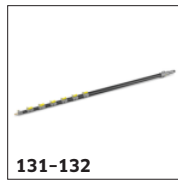

131-132



134



135-136



137



138-140

	Order no.	Description		
FACADE AND SOLAR PANEL CLEANING				
Brushes				
Brush soft	127	6.960-135.0	For simple installation on telescopic lances or high-pressure lances from Kärcher: brush with soft bristles for deep cleaning of sensitive surfaces such as glass or solar systems.	<input type="checkbox"/>
Telescopic				
TL low pressure adapter	128	4.580-097.0	TL low-pressure adapter comprising ball valve for tool-free installation on telescopic lances. Ideal for applications with rotating high-pressure brushes.	<input type="checkbox"/>
Telescopic lance TL 7 F	129	4.762-609.0	Telescopic lance TL 7 F with up to 7 m reach made from robust and lightweight glass fibre. With practical quick-release fasteners for simple retraction and extension.	<input type="checkbox"/>
Telescopic lance TL 7 H	130	4.762-610.0	Multifunctional hybrid telescopic lance TL 7 H made of rigid and lightweight carbon-glass fibre mix. Telescopic thanks to quick-release fastenings. Up to 7 m reach.	<input type="checkbox"/>
Telescopic lance TL 10 H	131	4.762-611.0	Up to 10 m reach: hybrid telescopic lance TL 10 H. Comprising carbon-glass fibre mix and suitable for multifunctional use. Simple retraction and extension thanks to quick-release fasteners.	<input type="checkbox"/>
Telescopic lance TL 10 C	132	4.762-612.0	Carbon fibre telescopic lance TL 10 C. With up to 10 m reach and practical quick-release fasteners. Multifunctional use for cleaning facades, windows or solar panels.	<input type="checkbox"/>
Telescopic lance TL 14 C	133	4.762-613.0	Maximum rigidity with minimum weight: telescopic lance TL 14 C made from carbon fibre. Enormous reach of 14 m, multifunctional use and easy to use thanks to quick-release fasteners.	<input type="checkbox"/>
TL high pressure adapter	134	4.775-154.0	TL high-pressure adapter, flexible high-pressure gun for high-pressure cleaning with telescopic lances. Ergonomic, easy to install, suitable for right- and left-handed individuals.	<input type="checkbox"/>
Wassereenthärtung				
WS 50	135	6.368-463.0	The mobile WS 50 water softening unit prevents lime residue on clean surfaces. A special ion-exchange resin removes the dissolved limescale from the water.	<input type="checkbox"/>
WS 100	136	6.368-464.0	The mobile WS 100 water softening unit prevents lime residue on clean surfaces. A special ion-exchange resin removes the dissolved limescale from the water.	<input type="checkbox"/>
WS Regenerator	137	6.368-465.0	With the WS Regenerator regeneration system, the softening cartridges of the water softening units WS 50 and WS 100 can be backflushed and regenerated at the push of a button.	<input type="checkbox"/>
Hoses				
Hose solar	138	6.392-978.0	High-quality, flexible HP hose (with rubber covering) for the iSolar TL 7. The outer layer has especially good sliding properties when extending and retracting the telescopic rod.	<input type="checkbox"/>
	139	6.392-977.0	High-quality, flexible HP hose (with rubber covering) for the iSolar TL 10. The outer layer has especially good sliding properties when extending and retracting the telescopic rod.	<input type="checkbox"/>
	140	6.392-976.0	High-quality, flexible HP hose (with rubber covering) for the iSolar TL 14. The outer layer has especially good sliding properties when extending and retracting the telescopic rod.	<input type="checkbox"/>

Available accessories.

EQUIPMENT FOR HD 10/25-4 S 1.286-902.0

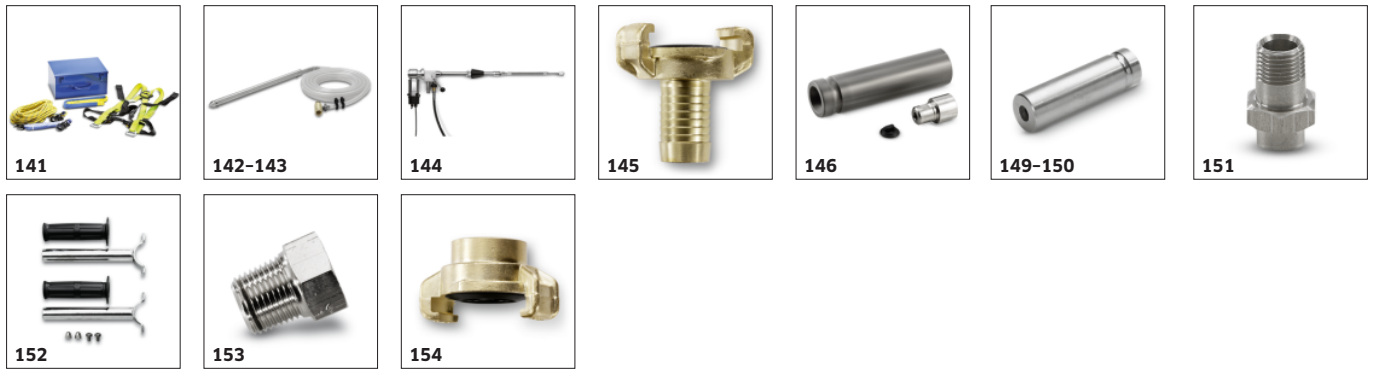

		Order no.	Description	
FACADE AND SOLAR PANEL CLEANING				
Attachment kits and adapters				
Case sheet steel	141	6.988-152.0	Certified personal security system for rooftop work. Contents: Travelling fall arrestor with shock absorber and 15 m kernmantle rope, harness, anchoring sling and sheet steel case.	<input type="checkbox"/>
WET BLASTING ATTACHMENT				
Wet blasting attachment (without nozzle)				
Wet blasting attachment with flow control (without nozzles)	142	4.115-000.0	Paint, rust and scale removal made easy: Kärcher wet blasting attachment with flow control for adding blasting abrasive to the high-pressure jet.	<input type="checkbox"/>
Wet blasting attachment without flow control (nozzles not included)	143	4.115-006.0	Paint, rust and scale removal made easy: Kärcher wet blasting attachment with flow control for adding blasting abrasive to the high-pressure jet. Without flow control.	<input type="checkbox"/>
Nozzle pack for wet blasting attachment				
Nozzle pack TR wet jet set 0050	144	2.112-023.0	Nozzle kit with wet blasting nozzle and nozzle insert (type specific). For optimal Kärcher wet blasting attachment performance. Only in combination with wet blasting attachment .	<input type="checkbox"/>
Boron carbide nozzle				
Boron carbide nozzle, for machines as of 1000 l/h	145	6.415-083.0	In addition to nozzle packs. Very wear-resistant nozzle with boron carbide chuck for continuous-duty operation.	<input type="checkbox"/>
DRUM AND TANK CLEANING				
Barrel and tank cleaning				
Barrel cleaner BC 14/12	146	2.112-020.0	The barrel cleaner BC 14/12 is a spray unit for the internal cleaning of containers and drums - in particular oak barrels with a capacity between 225 and 600 liters.	<input type="checkbox"/>
HKF 50 spray head, brass				
HKF 50 spray head , brass	147	3.631-039.0	Interior cleaning head for barrels and containers with bungholes of 50 mm and more.	<input type="checkbox"/>
HKF 50 spray head, brass	148	3.631-058.0		<input type="checkbox"/>
Nozzle kit for HKF 50 spray head (3.631-009.0 / 3.631-039.0)				
Nozzle 045 for dual nozzle operation HKF 50	149	6.415-446.0	Nozzle for dual-nozzle operation	<input type="checkbox"/>
Nozzle 090 for single nozzle operation HKF 50	150	6.415-447.0	Nozzle for single-nozzle operation	<input type="checkbox"/>
Double handle for exact control of the spray head	151	2.863-036.0	Double handle. Precise control of the spray head	<input type="checkbox"/>
Screw plug for using a spray head with one nozzle	152	5.411-061.0	Screw plug for using a spray head with one nozzle	<input type="checkbox"/>
WATER CONNECTION				
Geka coupling				
With hose nozzle, R 1"	153	6.388-465.0	with hose barb	<input type="checkbox"/>
Hose coupling	154	6.388-458.0	with female thread	<input type="checkbox"/>

Available accessories.

EQUIPMENT FOR HD 10/25-4 S 1.286-902.0



155



156



158



159



160-161



162



163



164



165

	Order no.	Description		
WATER CONNECTION				
Suction filter				
Water filter	155	6.414-956.0	Suitable for ponds, storage tanks or similar, polyamide filter casing, stainless steel strainer, 800 µm mesh, R 3/4" and R 1" connection, without non-return valve	<input type="checkbox"/>
Suction filter with check valve	156	4.730-012.0	Brass suction filter suitable for ponds, storage tanks, etc. With check valve.	<input type="checkbox"/>
Fine-mesh water filter				
Add-on kit water filter universal	157	2.637-020.0		<input type="checkbox"/>
Fine-mesh water filter with adapter	158	4.730-102.0	Fine-mesh water filter, 125 µm, max. temperature 50°C. Protects the high-pressure cleaner from dirt particles contained in the water. Water flow rate up to 1200 l/h. Connection 3/4", with adapter, 1".	<input type="checkbox"/>
Fine-mesh water filter, 100 µm, R 1"	159	2.638-270.0	Fine-mesh water filter, 100 µm, max. temperature 60°C. Connects to high-pressure cleaner. Protects the high-pressure cleaner from dirt particles contained in the water. Water flow rate up to 1200 l/h. Connector 1".	<input type="checkbox"/>
Water supply hose				
Water supply hose	160	4.440-207.0	NW 19 R1" / R 3/4", up to 85 °C, for pick-up	<input type="checkbox"/>
	161	4.440-270.0	NW 19 R1" / R1", up to 85 °C	<input type="checkbox"/>
Backflow check valve				
Backflow preventer	162	2.641-374.0	To prevent detergent getting into the drinking water cycle in case of inlet at low-pressure. - hot water resistant up to 80 °C - tested according to IEC 60335-2-79 - integrated leakage protection	<input type="checkbox"/>
WASHING BRUSHES				
Push-on washing brush				
Push-on wash brush, M 18 × 1.5	163	4.113-001.0	Push-on wash brush for universal use. Simply push on to lance. Connector: M 18 × 1.6.	<input type="checkbox"/>
Rotating washing brush				
Rotating wash brush for > 800 l/h machines, nylon bristles	164	4.113-002.0	Driven by water stream. Gently removes fine dust and traffic film from any surface. Temperature resistant up to 60°C, M 18 × 1.5 (replaceable brush insert).	<input type="checkbox"/>
Rotating wash brush for > 800 l/h machines, natural bristles	165	4.113-005.0		<input type="checkbox"/>

Available accessories.