

# LE MARAIS



LUXE

# LE MARAIS - Two Tier 47

Elegant chandelier with a unique hand crafted french plaster finish in classic Ivory or dramatic Charcoal. Inspired by Giacometti's sculptures commissioned by the Musee Picasso in Paris, the graceful lines of Le Marais portray a delicate strength and a modern yet timeless point of view.

LUXE lighting collections are handcrafted from the finest materials, combining classic motifs with contemporary flair to create signature illuminated features that are equal part light and art. Balancing light and shadow, color and clarity, each LUXE lighting fixture is a one of a kind creation.

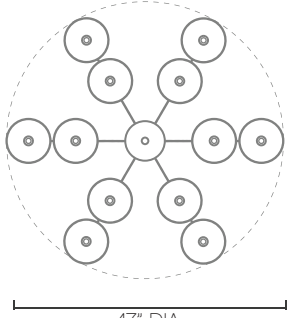
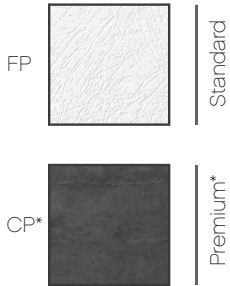
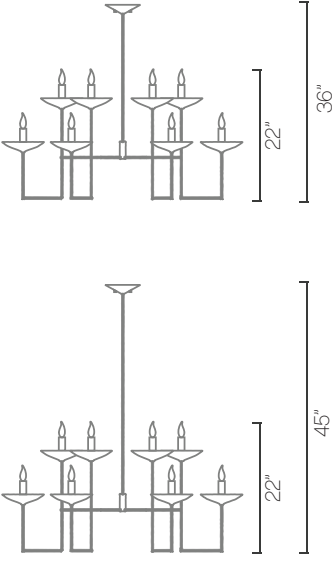
NAME (LM) LE MARAIS	MODEL (M47) 47" Two Tier Chandelier	FINISHES (FP) Ivory French Plaster (CP) Charcoal French Plaster*	OVERALL HEIGHT 36" 45" (HX) Custom*
	 <p>47" DIA.</p> <p>Two Tier Chandelier</p>	 <p>FP Standard</p> <p>CP* Premium*</p>	 <p>36"</p> <p>22"</p> <p>45"</p> <p>22"</p> <p>(HX) Custom*</p>

Lamping: M47(12) 25-60W E12, 120V Dimmable  
(LED and Antique style bulbs available)  
UL listed (or equivalent) for dry location

\*Indicates custom or premium options available.

SPECIFICATION SELECTION: \_\_\_\_\_ LM \_\_\_\_\_ • \_\_\_\_\_ M47 \_\_\_\_\_ • \_\_\_\_\_

PROJECT NAME: \_\_\_\_\_ DATE: \_\_\_\_\_

NOTES: \_\_\_\_\_



# LE MARAIS



LUXE

# LE MARAIS - Single 42

Elegant chandelier with a unique hand crafted french plaster finish in classic Ivory or dramatic Charcoal. Inspired by Giacometti's sculptures commissioned by the Musee Picasso in Paris, the graceful lines of Le Marais portray a delicate strength and a modern yet timeless point of view.

LUXE lighting collections are handcrafted from the finest materials, combining classic motifs with contemporary flair to create signature illuminated features that are equal part light and art. Balancing light and shadow, color and clarity, each LUXE lighting fixture is a one of a kind creation.

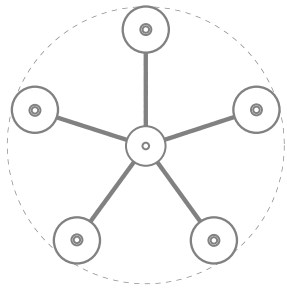
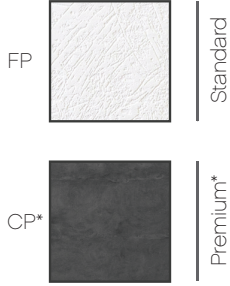
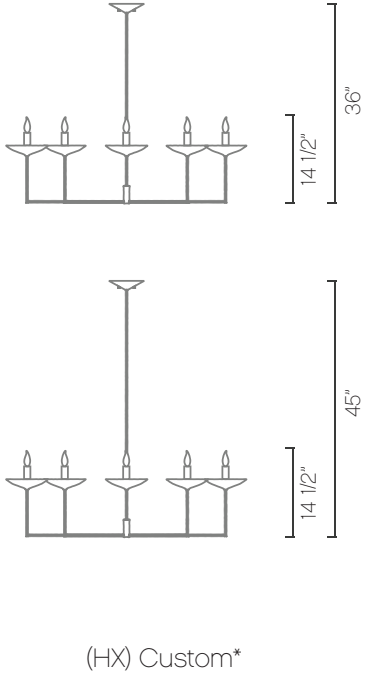
NAME (LM) LE MARAIS	MODEL (C42) 42" Single Tier Chandelier	FINISHES (FP) Ivory French Plaster (CP) Charcoal French Plaster*	OVERALL HEIGHT 36" 45" (HX) Custom*
 by Thomas Cooper Studio	 <p>42" DIA. Single Tier Chandelier</p>		
	<p>Lamping: C42 (5) 25-60W E12, 120V Dimmable (LED and Antique style bulbs available) UL listed (or equivalent) for dry location</p> <p>*Indicates custom or premium options available.</p>		

SPECIFICATION SELECTION: \_\_\_\_\_ LM \_\_\_\_\_ • \_\_\_\_\_ C42 \_\_\_\_\_ • \_\_\_\_\_

PROJECT NAME: \_\_\_\_\_ DATE: \_\_\_\_\_

NOTES: \_\_\_\_\_



LE MARAIS



LUXE

# LE MARAIS - Sconce

Elegant sconces in single tapers with a unique hand crafted french plaster finish in classic Ivory or dramatic Charcoal. Inspired by Giacometti's sculpture commissioned by the Musee Picasso in Paris, the graceful lines of LE MARAIS portray a delicate strength and a modern yet timeless point of view.

LUXE lighting collections are handcrafted from the finest materials, combining classic motifs with contemporary flair to create signature illuminated features that are equal part light and art. Balancing light and shadow, color and clarity, each LUXE lighting fixture is a one of a kind creation.

NAME  
(LM) LE MARAIS

MODEL  
(S16) Single Piccolo Sconce

METAL FINISHES  
(FP) Ivory French Plaster  
(CP) Charcoal French Plaster\*

LE MARAIS  
by Thomas Cooper Studio

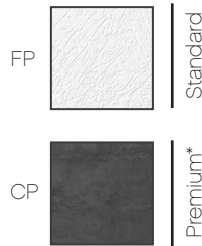
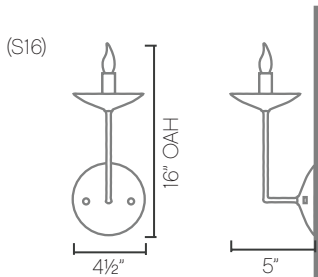

Lamping: S16 (1) 25-60W E12, 120V Dimmable  
(LED and Antique style Edison bulbs available)  
UL listed (or equivalent) for dry location

\*Indicates custom or premium options available.

SPECIFICATION SELECTION: \_\_\_\_\_ LM \_\_\_\_\_ • \_\_\_\_\_ S16 \_\_\_\_\_ • \_\_\_\_\_

PROJECT NAME: \_\_\_\_\_ DATE: \_\_\_\_\_

NOTES: \_\_\_\_\_



3400 MEDFORD STREET, LOS ANGELES, CA 90063  
TEL 323-227-9207 SALES@LUXELIGHTANDHOME.COM

Spring 2018

LE MARAIS



LUXE

# LE MARAIS - Sconce

Elegant sconces in single tapers with a unique hand crafted french plaster finish in classic Ivory or dramatic Charcoal. Inspired by Giacometti's sculpture commissioned by the Musee Picasso in Paris, the graceful lines of LE MARAIS portray a delicate strength and a modern yet timeless point of view.

LUXE lighting collections are handcrafted from the finest materials, combining classic motifs with contemporary flair to create signature illuminated features that are equal part light and art. Balancing light and shadow, color and clarity, each LUXE lighting fixture is a one of a kind creation.

NAME  
(LM) LE MARAIS

MODEL  
(S21) Single Alto Sconce

METAL FINISHES  
(FP) Ivory French Plaster  
(CP) Charcoal French Plaster\*

LE MARAIS  
by Thomas Cooper Studio

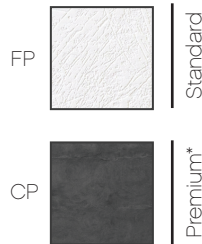
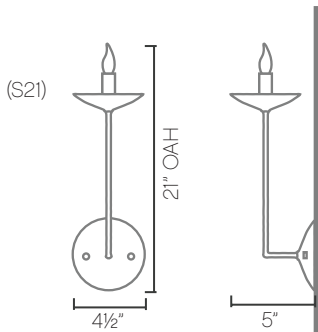

Lamping: S21 (1) 25-60W E12, 120V Dimmable  
(LED and Antique style Edison bulbs available)  
UL listed (or equivalent) for dry location

\*Indicates custom or premium options available.

SPECIFICATION SELECTION: \_\_\_\_\_ LM \_\_\_\_\_ • \_\_\_\_\_ S21 \_\_\_\_\_ • \_\_\_\_\_

PROJECT NAME: \_\_\_\_\_ DATE: \_\_\_\_\_

NOTES: \_\_\_\_\_



3400 MEDFORD STREET, LOS ANGELES, CA 90063  
TEL 323-227-9207 SALES@LUXELIGHTANDHOME.COM

Spring 2018



LE MARAIS



LUXE

# LE MARAIS - Two Taper Sconce

Elegant sconces in two tapers with a unique hand crafted french plaster finish in classic Ivory or dramatic Charcoal. Inspired by Giacometti's sculpture commissioned by the Musee Picasso in Paris, the graceful lines of LE MARAIS portray a delicate strength and a modern yet timeless point of view.

LUXE lighting collections are handcrafted from the finest materials, combining classic motifs with contemporary flair to create signature illuminated features that are equal part light and art. Balancing light and shadow, color and clarity, each LUXE lighting fixture is a one of a kind creation.

NAME  
(LM) LE MARAIS

MODEL  
(SL) Two Taper Left Sconce  
(SR) Two Taper Right Sconce

METAL FINISHES  
(FP) Ivory French Plaster  
(CP) Charcoal French Plaster\*

LE MARAIS  
by Thomas Cooper Studio

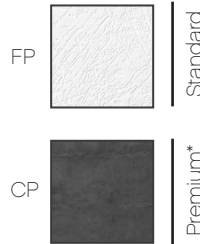
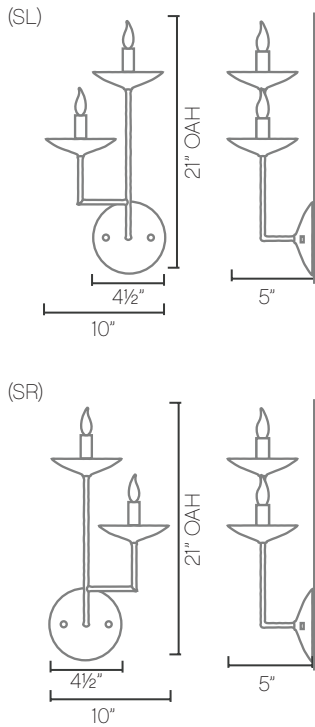

Lamping: SL, SR (2) 25-60W E12 12, 120V Dimmable  
(LED and Antique style Edison bulbs available)  
UL listed (or equivalent) for dry location

\*Indicates custom or premium options available.

SPECIFICATION SELECTION: \_\_\_\_\_ LM \_\_\_\_\_ • \_\_\_\_\_ • \_\_\_\_\_

PROJECT NAME: \_\_\_\_\_ DATE: \_\_\_\_\_

NOTES: \_\_\_\_\_



3400 MEDFORD STREET, LOS ANGELES, CA 90063  
TEL 323-227-9207 SALES@LUXELIGHTANDHOME.COM

Spring 2018