



➤➤ **DATA SHEET**  
( DOC No. HX8526-E30ADCG-DS )

➤➤ **HX8526-E30ADCG**  
Touch Screen Controller  
*Version 01 September, 2014*

» **HX8526-E30ADCG**

Touch Screen Controller



Himax Technologies, Inc.  
<http://www.himax.com.tw>

***Revision History***

*September, 2014*

Version	Date	Description of Changes
01	2014/09/15	New setup.

Himax Confidential  
Do Not Copy

### Revision History

September, 2014

1.	General Description .....	5
2.	Features .....	5
3.	System Diagram .....	6
4.	Pin Description .....	7
4.1	HX8526-E30ADCG 40-pin QFN .....	7
5.	Pin Assignment .....	8
5.1	HX8526-E30ADCG 40-pin QFN .....	8
6.	Package Information .....	9
6.1	HX8526-E30ADCG 40-pin QFN (5mm×5mm×0.65mm) .....	9
7.	Absolute Maximum Ratings .....	10
8.	Thermal Information .....	10
9.	ESD Rating .....	10
10.	Electrical Specifications .....	11
10.1	DC characteristics .....	11
10.2	AC characteristics of the SDA and SCL bus lines for I <sup>2</sup> C-bus devices .....	12
11.	Interface .....	13
11.1	System interface .....	13
11.2	Transfer protocol (I <sup>2</sup> C interface) .....	13
11.2.1	Format of data frame (I <sup>2</sup> C interface) .....	15
12.	Flash Programming .....	16
12.1	Flash programming flow .....	16
13.	Command .....	17
13.1	Command list .....	17
13.1.1	Standard command .....	17
13.1.2	User define command list table .....	17
13.2	Command description .....	18
13.2.1	NOP .....	18
13.2.2	TS sleep in (80h) .....	19
13.2.3	TS sleep out (81h) .....	20
13.2.4	TS sense off (82h) .....	21
13.2.5	TS sense on (83h) .....	22
13.2.6	Read one event (85h) .....	23
13.2.7	Read all event (86h) .....	24
13.2.8	Read latest event (87h) .....	25
13.2.9	Clear event stack (88h) .....	26
13.2.10	IC part number (D1h) .....	27
14.	Reference circuit .....	28
14.1	HX8526-E30ADCG .....	28
15.	Ordering Information .....	29

**List of Figures**

September, 2014

Figure 10.1: I <sup>2</sup> C timing .....	12
Figure 11.1: I <sup>2</sup> C signal timing .....	13
Figure 11.2: I <sup>2</sup> C START/STOP .....	13
Figure 11.3: I <sup>2</sup> C data transfer .....	14
Figure 11.4: Data format of writing mode .....	15
Figure 11.5: Data format of reading mode .....	15
Figure 12.1: Flash programming flow .....	16

Himax Confidential  
Do Not Copy

## 1. General Description

HX8526-E30ADCG is a capacitive touch screen control IC designed for I<sup>2</sup>C interface that supports touch screen of 30 sensing channels I/O. HX8526-E30ADCG also provide flexibility and selective functionality solution for the variety application of touch screen.

HX8526-E30ADCG supports the flash memory to store calibration data and application parameters. HX8526-E30ADCG is suitable for any capacitive touch screen application combined with high performance controller and friendly user interfaces, and wide operating temperature range.

## 2. Features

- Projective touch screen control IC
- Programmable scan line
- Support 30 channels I/O
- Both self capacitance and mutual capacitance technology adopted
  - HX8526-E30ADCG for multi touch (**All points**)
- Low power consumption
- Auto noise filter function
- Support I<sup>2</sup>C interface
- Customer function design (**Embedded with RDC8051**)
  - 256 byte scratchpad RAM interface
  - 12K byte external RAM
  - 32K flash program memory address space
- 2.7V to 3.6V operating voltage
  - VCCA(**Analog power**)=2.7V to 3.6V.
  - VCCD(**Digital power**)=1.65V to 3.6V.
- Temperature range: -40 ~ +85 °C
- Flash memory to store calibration data and application parameters

### 3. System Diagram

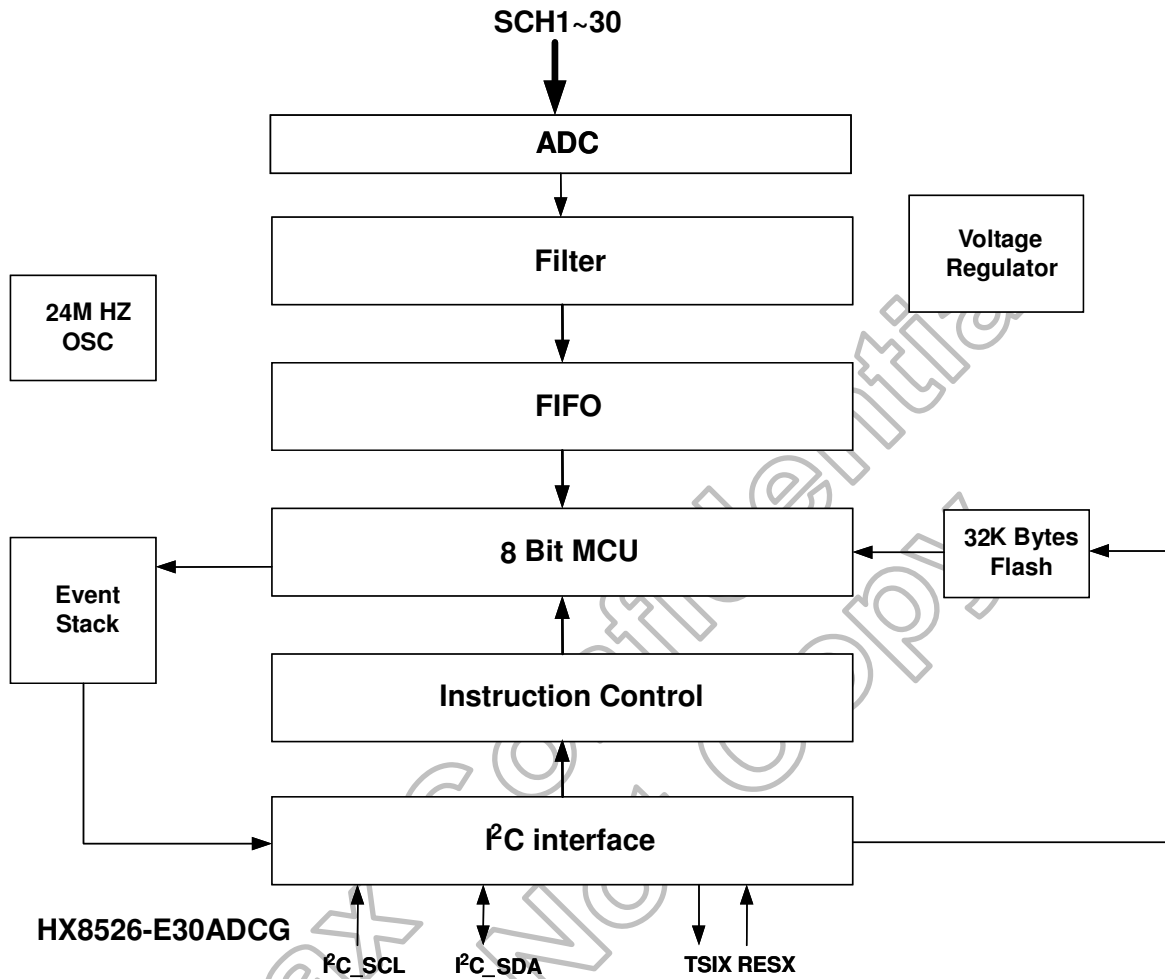

## 4. Pin Description

### 4.1 HX8526-E30ADCG 40-pin QFN

No.	Type	Name	Description
1	In/Out	SCH1	Touch screen channel (SCH1)
2	In/Out	SCH2	Touch screen channel (SCH2)
3	In/Out	SCH3	Touch screen channel (SCH3)
4	In/Out	SCH4	Touch screen channel (SCH4)
5	In/Out	SCH5	Touch screen channel (SCH5)
6	In/Out	SCH6	Touch screen channel (SCH6)
7	In/Out	SCH7	Touch screen channel (SCH7)
8	In/Out	SCH8	Touch screen channel (SCH8)
9	In/Out	SCH9	Touch screen channel (SCH9)
10	In/Out	SCH10	Touch screen channel (SCH10)
11	In	XRES	Active low external reset.
12	Out	TSIX	Touch Screen Interrupt. Touch screen Interrupt line; Interrupt active when the line is low.
13	Output	TEST_RX	Test pin. It is for internal test or GPIO pin used. Let it open if not used.
14	IO	I <sup>2</sup> C_SDA <sup>(1)</sup>	Data line for I <sup>2</sup> C interface. Connect the optional damping resistance 330 Ohm if I <sup>2</sup> C trace length on main board is approximate or larger than 100mm.
15	In	I <sup>2</sup> C_SCL <sup>(1)</sup>	Serial clock lines for I <sup>2</sup> C interface. Connect the optional damping resistance 330 Ohm if I <sup>2</sup> C trace length on main board is approximate or larger than 100mm.
16	Power	VCCD	Digital power supply voltage. The range is 1.65V ~ 3.6V. Connect the optional stabilizing capacitor 1μF.
17	Power	VSS	Ground connection.
18	Power	VCCA	Analog power supply voltage. The range is 2.7V ~ 3.6V. Connect the optional stabilizing capacitor 1μF.
19	Power	CVDD	Connect the optional stabilizing capacitor 1μF.
20	Power	VCIOUT	Connect the optional stabilizing capacitor 1uF.
21	In/Out	SCH11	Touch screen channel (SCH11)
22	In/Out	SCH12	Touch screen channel (SCH12)
23	In/Out	SCH13	Touch screen channel (SCH13)
24	In/Out	SCH14	Touch screen channel (SCH14)
25	In/Out	SCH15	Touch screen channel (SCH15)
26	In/Out	SCH16	Touch screen channel (SCH16)
27	In/Out	SCH17	Touch screen channel (SCH17)
28	In/Out	SCH18	Touch screen channel (SCH18)
29	In/Out	SCH19	Touch screen channel (SCH19)
30	In/Out	SCH20	Touch screen channel (SCH20)
31	In/Out	SCH21	Touch screen channel (SCH21)
32	In/Out	SCH22	Touch screen channel (SCH22)
33	In/Out	SCH23	Touch screen channel (SCH23)
34	In/Out	SCH24	Touch screen channel (SCH24)
35	In/Out	SCH25	Touch screen channel (SCH25)
36	In/Out	SCH26	Touch screen channel (SCH26)
37	In/Out	SCH27	Touch screen channel (SCH27)
38	In/Out	SCH28	Touch screen channel (SCH28)
39	In/Out	SCH29	Touch screen channel (SCH29)
40	In/Out	SCH30	Touch screen channel (SCH30)

**Note:** (1) The HX8526-E30ADCG QFN only support I<sup>2</sup>C interface and the slave address is 90/94h.

## 5. Pin Assignment

### 5.1 HX8526-E30ADCG 40-pin QFN

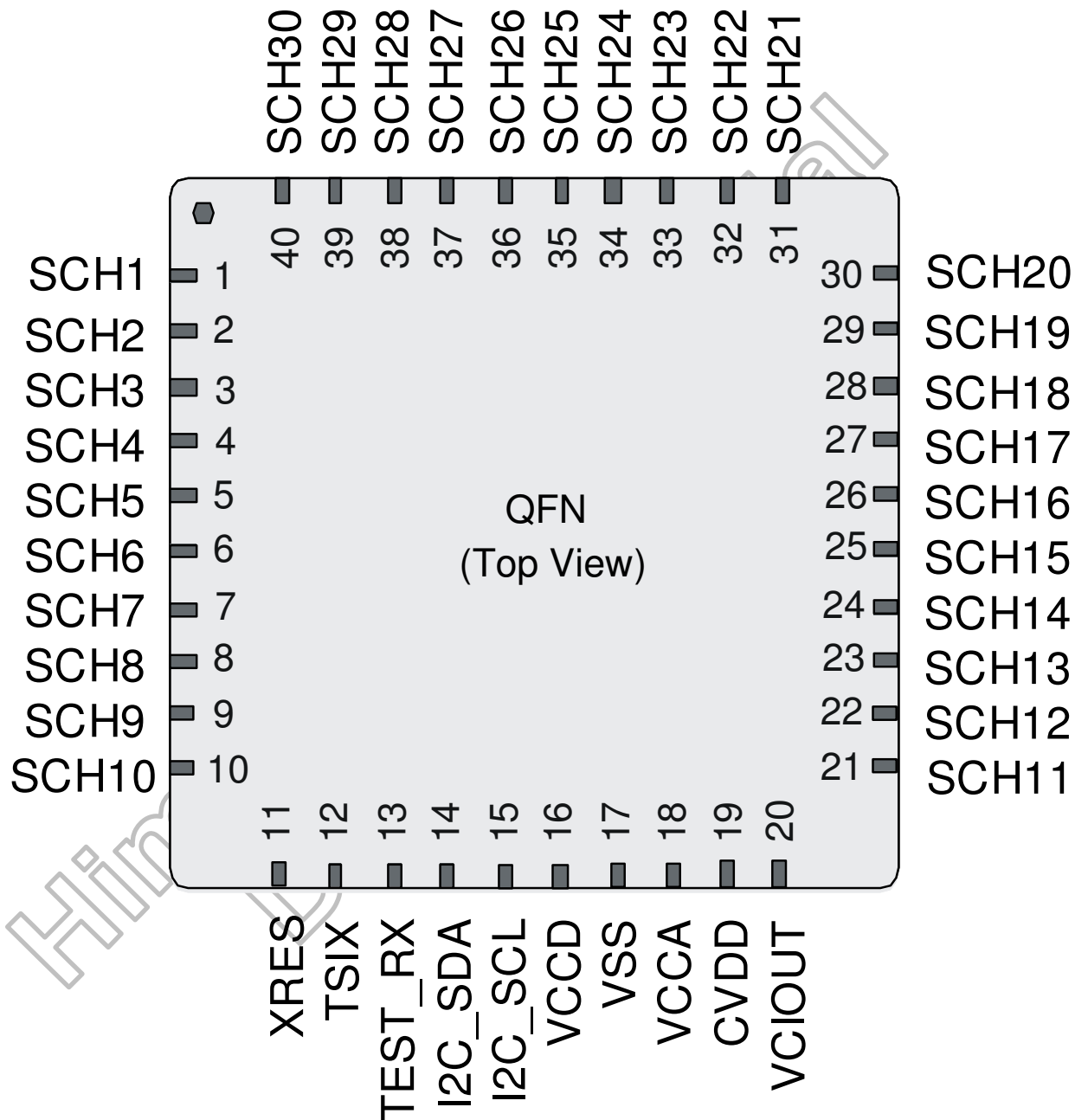



## 6. Package Information

### 6.1 HX8526-E30ADCG 40-pin QFN (5mm×5mm×0.65mm)

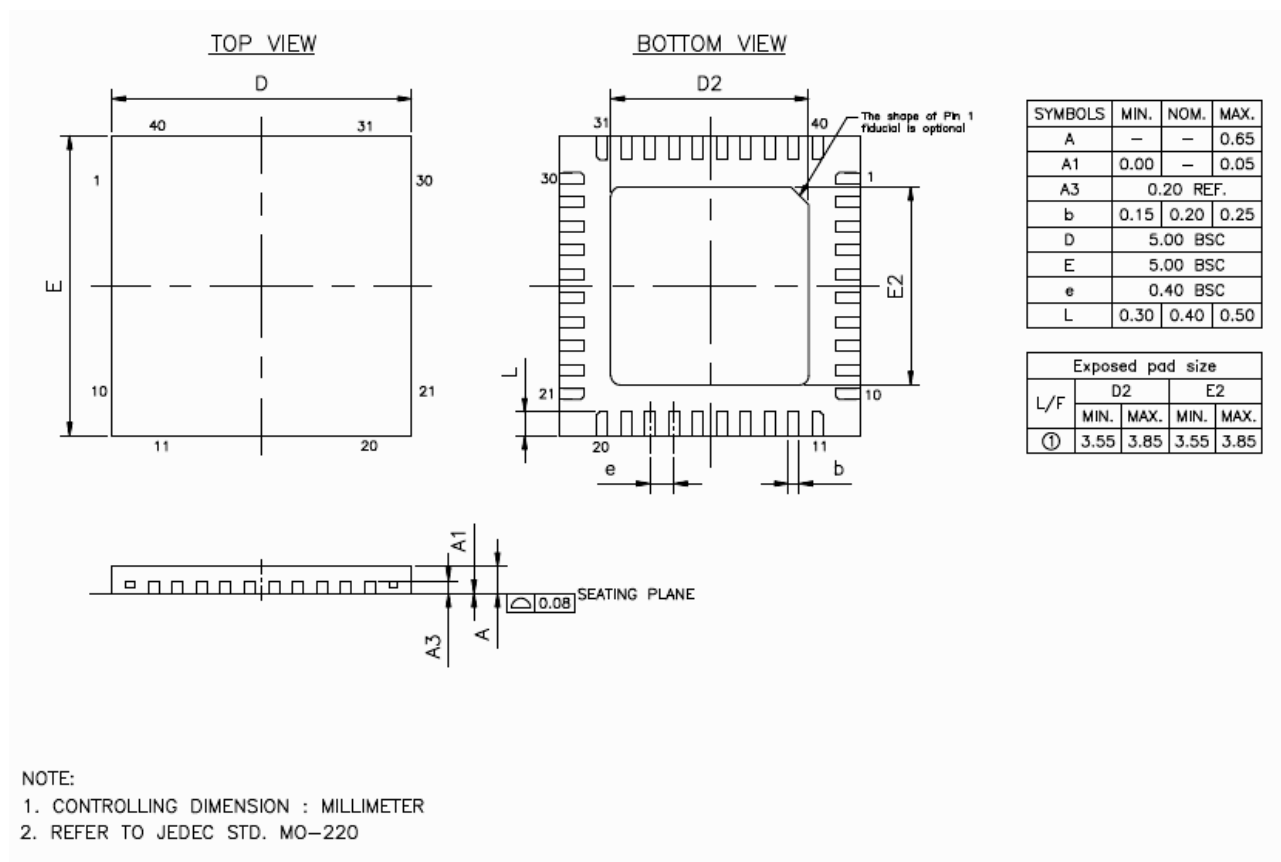

Himax  
Down

## 7. Absolute Maximum Ratings

Parameter	Symbol	Spec.			Unit
		Min.	Typ.	Max.	
Supply voltage	$V_{IN}$	-0.3	-	7	V
Switch control signals output current	Output current	-	50	-	mA
Enable control voltage range	Logic Input	-0.3	-	$V_{IN}+0.3$	V
Output control driver	Output voltage	-0.3	-	$V_{IN}$	V

## 8. Thermal Information

Parameter	Symbol	Spec.			Unit
		Min.	Typ.	Max.	
Operating junction temperature	$T_J$	-40	-	125	°C
Operating temperature range (Ambient)	$T_{OP}$	-40	-	85	°C
Storage temperature range	$T_{STG}$	-55	-	150	°C
Lead soldering temperature, 10 seconds	-	-	-	260	°C
Power dissipation @ $T_A=25^{\circ}C$ (no load, fop=100kHz)	$P_D$	-	-	50	mW
Thermal resistance	$T_{JA}$	-	-	165	°C/W

## 9. ESD Rating

Parameter	Symbol	Spec.			Unit
		Min.	Typ.	Max.	
Human body model	ESD	-	2	-	KV
Machine model		-	200	-	V

## 10. Electrical Specifications

### 10.1 DC characteristics

(VCCD=1.65 ~ 3.6V, VCCA=2.7 ~ 3.6V, T<sub>A</sub>=-40 ~ 85 °C)

Parameter	Symbol	Condition	Spec.			Unit
			Min.	Typ.	Max.	
Input high voltage	V <sub>IH</sub>	VCCD=1.65 ~ 3.6V	0.7VCCD	-	VCCD	V
Input low voltage	V <sub>IL</sub>	VCCA=2.7 ~ 3.6V	0	-	0.3VCCD	V
Output low voltage (SDO)	V <sub>OL1</sub>	VCCD=1.65 ~ 3.6V I <sub>OL</sub> =1.0mA	0	-	0.2VCCD	V
Current consumption deep-standby mode (VCCA/VCCD-VSS)	I <sub>ST(VDD)</sub>	VCCA=3.3V, VCCD=3.3V, T <sub>A</sub> =25°C	-	20	-	μA
Current consumption active mode (VCCA/VCCD-VSS)	I <sub>ACTIVE(VDD)</sub>	VCCA=3.3V, VCCD=3.3V, T <sub>A</sub> =25°C	-	Note <sup>(1)</sup>	-	mA
Current consumption idle mode (VCCA/VCCD-VSS)	I <sub>ACTIVE(VDD)</sub>	VCCA=3.3V, VCCD=3.3V, T <sub>A</sub> =25°C	-	Note <sup>(2)</sup>	-	mA
Minimum slew rate of VCCA and VCCD	-	-	1	-	-	V/ms
Ripple voltage of VCCD and VCCA	V <sub>R</sub>	VCCA=3.3V, VCCD=3.3V, T <sub>A</sub> =25°C	-	-	100	mV

Note 1: Depend on report rate setting, the range is 7 ~ 10mA.

Note 2: Depend on report rate setting, the range is 0.6 ~ 0.9mA.

10.2 AC characteristics of the SDA and SCL bus lines for I<sup>2</sup>C-bus devices

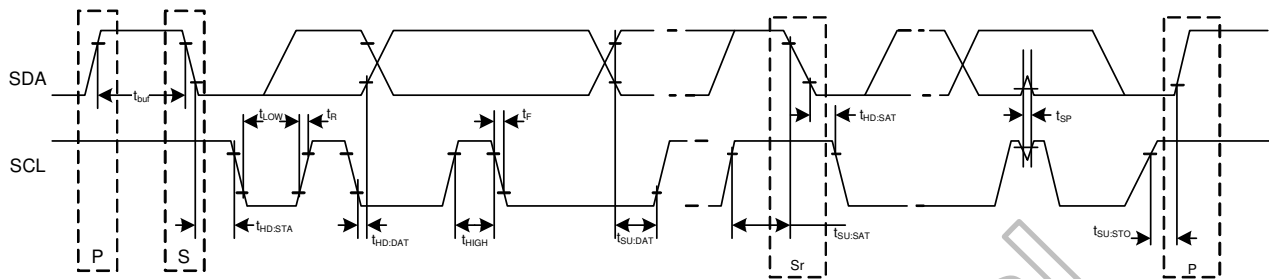

Figure 10.1: I<sup>2</sup>C timing

Parameter	Symbol	Standard-mode I <sup>2</sup> C-bus		Fast-mode I <sup>2</sup> C-bus		Unit
		Min.	Max.	Min.	Max.	
SCL clock frequency	$f_{SCL}$	0	100	0	400	KHz
Bus free time between STOP and START condition	$t_{BUF}$	4.7	-	1.3	-	$\mu$ s
Hold time (repeated) START condition. After this period, the first clock pulse is generated	$t_{HD:STA}$	4.0	-	0.6	-	$\mu$ s
Low period of the SCL clock	$t_{LOW}$	4.7	-	1.3	-	$\mu$ s
High period of the SCL clock	$t_{HIGH}$	4.0	-	0.6	-	$\mu$ s
Setup time for a repeated START condition	$t_{SU:STA}$	4.7	-	0.6	-	$\mu$ s
Data hold time	$t_{HD:DAT}$	0	-	0	0.9	$\mu$ s
Data setup time	$t_{SU:DAT}$	250	-	100	-	ns
Rise time of both SDA and SCL signals	$t_R$	-	1000	$20+0.1 C_b$	300	ns
Fall time of both SDA and SCL signals	$t_F$	-	300	$20+0.1 C_b$	300	ns
Setup time for STOP condition	$t_{SU:STO}$	4.0	-	0.6	-	$\mu$ s
Capacitive load for each bus line.	$C_b$	-	400	-	400	pF

- Note:** (1) All values are referred to VIH (0.7VCCD) and VIL (0.3VCCD) level.  
 (2) A device must internally provide a hold time of at least 300ns for the SDA signal (referred to the VIH of the SCL signal) in order to bridge the undefined region of the falling edge of SCL.  
 (3) The maximum  $t_{HD:DAT}$  has only to be met if the device does not stretch the low period ( $t_{LOW}$ ) of the SCL signal.  
 (4) A fast-mode I<sup>2</sup>C-bus device can be used in a standard-mode I<sup>2</sup>C-bus system, but the requirement  $t_{SU:DAT} \geq 250$ ns must then be met. This will automatically be the case if the device does not stretch the low period of the SCL signal. If such a device does stretch the low period of the SCL signal, it must output the next data bit to the SDA line  $t_{Rmax} + t_{SU:DAT} = 1000+250=1250$ ns (according to the standard-mode I<sup>2</sup>C-bus specification) before the SCL line is released.  
 (5)  $C_b$  = total capacitance of one bus line in pF.  
 (6) If a spark or noise appear on SDA line and keep more than 25ns, START or STOP condition will be identified if SCL line keep high at this time.

## 11. Interface

### 11.1 System interface

The HX8526-E30ADCG supports I<sup>2</sup>C interface (NXP(x-Philips) serial interface).

### 11.2 Transfer protocol (I<sup>2</sup>C interface)

HX8526-E30ADCG support I<sup>2</sup>C interface that need 2 hardware pin – serial data (SDA) and serial clock (SCL), carry information between the devices connected to the bus. The I<sup>2</sup>C bus supports serial, 8-bit oriented, bi-directional data transferred at a rate up to 100Kbit/s in the standard-mode, or up to 400Kbit/s in the fast-mode.

The data on the SDA line must be stable during the high period of the clock. The high or low state of the data line can only change when the clock signal on the SCL line is low.

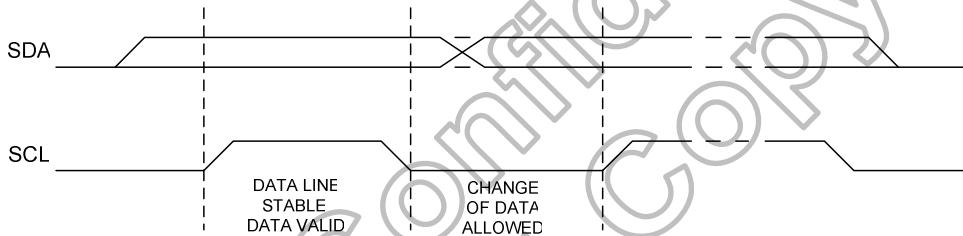

Figure 11.1: I<sup>2</sup>C signal timing

Within the procedure of the I<sup>2</sup>C-bus, unique situations arise which are defined as START and STOP conditions. A high to low transition on the SDA line while SCL is high is one such unique case. This situation indicates a START condition. A low to high transition on the SDA line while SCL is high defines a STOP condition. START and STOP conditions are always generated by the master. The I<sup>2</sup>C bus is considered to be busy after the START condition. The I<sup>2</sup>C bus is considered to be free again a certain time after the STOP condition.

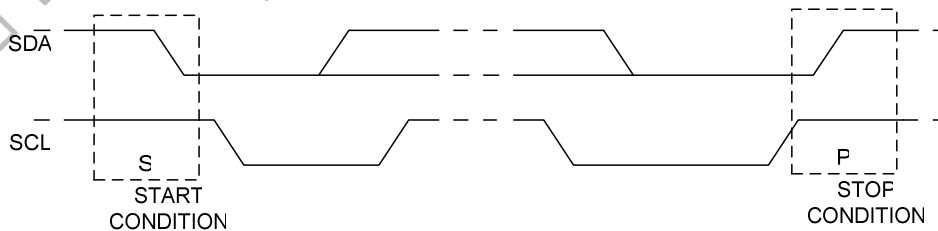

Figure 11.2: I<sup>2</sup>C START/STOP

The HX8526-E30ADCG only supports I<sup>2</sup>C interface and the slave address is 90/94h. In I<sup>2</sup>C slave mode, HX8526-E30ADCG waits for Master reading the data and acknowledges. Every byte put on the SDA line must be 8-bits long. The number of bytes that can be transmitted per transfer is unrestricted. Each byte has to be followed by an acknowledge bit. Data is transferred with the most significant bit (MSB) first.

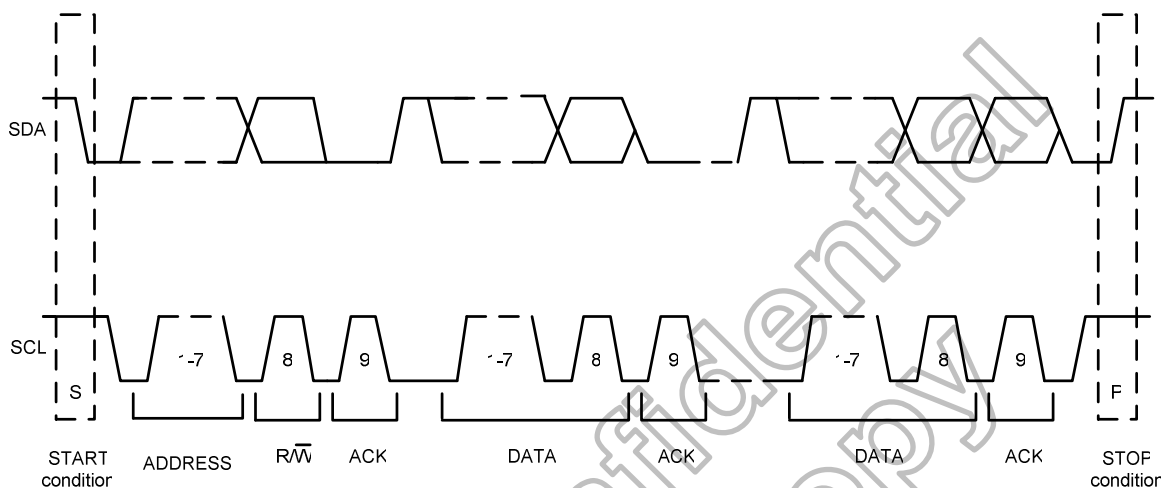

Figure 11.3: I<sup>2</sup>C data transfer

11.2.1 Format of data frame (I<sup>2</sup>C interface)

When master sends the command which be received by HX8526-E30ADCG, the HX8526-E30ADCG will responses the code and data. The format of communication is shown as Figure 11.4. The Command table that is written by master is defined on Table11.1 Command Table. HX8526-E30ADCG wills response the response code first and data later.

Write mode

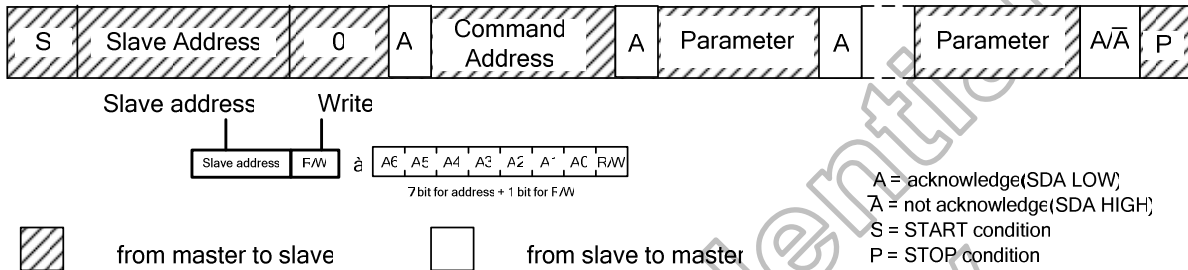

Figure 11.4: Data format of writing mode

Read mode

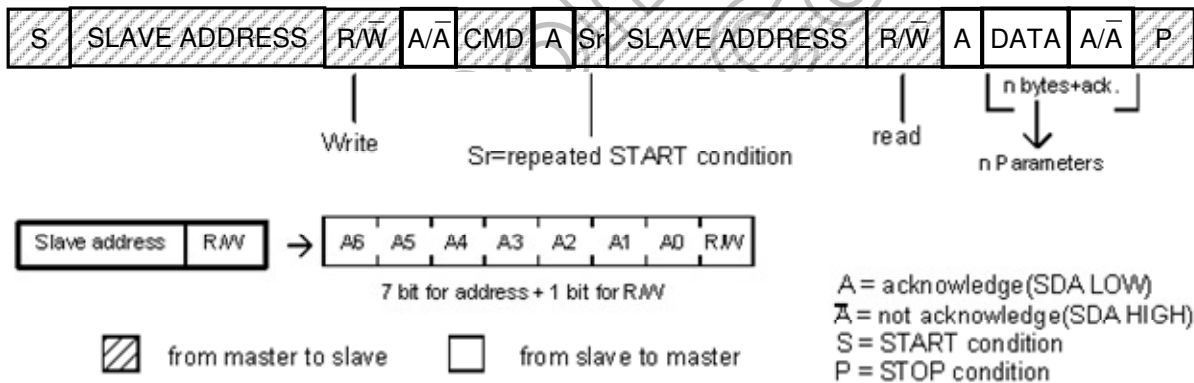

Figure 11.5: Data format of reading mode

## 12. Flash Programming

### 12.1 Flash programming flow

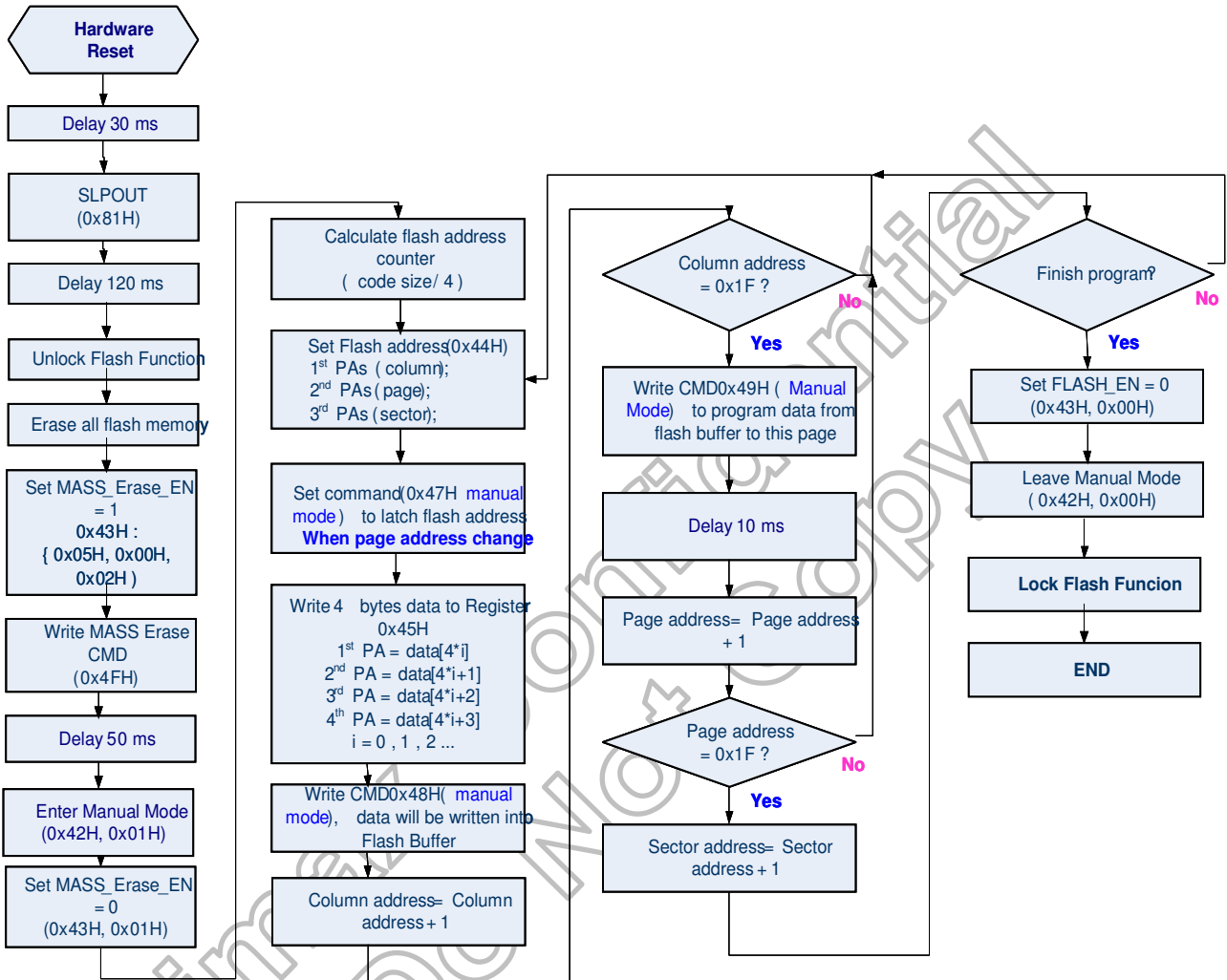

Figure 12.1: Flash programming flow



### 13. Command

#### 13.1 Command list

##### 13.1.1 Standard command

(Hex)	Operation Code	D7	D6	D5	D4	D3	D2	D1	D0	Function
0	No operation	0	0	0	0	0	0	0	0	-
80	Sleep in	1	0	0	0	0	0	0	0	-
81	Sleep out	1	0	0	0	0	0	0	1	-
82	Sense off	1	0	0	0	0	0	1	0	-
83	Sense on	1	0	0	0	0	0	1	1	-
85	Read event	1	0	0	0	0	1	0	1	-
	1 <sup>st</sup> parameter	B31	B30	B29	B28	B27	B26	B25	B24	-
	2 <sup>nd</sup> parameter	B23	B22	B21	B20	B19	B18	B17	B16	-
	3 <sup>rd</sup> parameter	B15	B14	B13	B12	B11	B10	B9	B8	-
	4 <sup>th</sup> parameter	B7	B6	B5	B4	B3	B2	B1	B0	-
86	Read all events	1	0	0	0	0	1	1	0	-
	1 <sup>st</sup> parameter	B31	B30	B29	B28	B27	B26	B25	B24	-
	2 <sup>nd</sup> parameter	B23	B22	B21	B20	B19	B18	B17	B16	-
	3 <sup>rd</sup> parameter	B15	B14	B13	B12	B11	B10	B9	B8	-
	4 <sup>th</sup> parameter	B7	B6	B5	B4	B3	B2	B1	B0	-
	5 <sup>th</sup> parameter	E3	E2	E1	E0	F1	P2	P1	P0	-
	6 <sup>th</sup> parameter	B23	B22	B21	B20	B19	B18	B17	B16	-
	⋮	⋮	⋮	⋮	⋮	⋮	⋮	⋮	⋮	⋮
	(n+1) <sup>th</sup> parameter	B7	B6	B5	B4	B3	B2	B1	B0	-
87	Read latest event	1	0	0	0	0	1	1	1	-
	1 <sup>st</sup> parameter	B31	B30	B29	B28	B27	B26	B25	B24	-
	2 <sup>nd</sup> parameter	B23	B22	B21	B20	B19	B18	B17	B16	-
	3 <sup>rd</sup> parameter	B15	B14	B13	B12	B11	B10	B9	B8	-
	4 <sup>th</sup> parameter	B7	B6	B5	B4	B3	B2	B1	B0	-
88	Clear Stack	1	0	0	0	1	0	0	0	-

##### 13.1.2 User define command list table

CMD (Hex)	Operation code	D7	D6	D5	D4	D3	D2	D1	D0	Function
D1h	SETID1	1	1	0	1	0	0	0	1	SETID1
	1 <sup>st</sup> parameter	ID1[7:0] (8'h00)								
	2 <sup>nd</sup> parameter	1'b1	ID2[6:0]							
	3 <sup>rd</sup> parameter	ID3[7:0] (8'h00)								

### 13.2 Command description

#### 13.2.1 NOP

00 H	NOP (No Operation)									
	DNC	D7	D6	D5	D4	D3	D2	D1	D0	HEX
Command	0	0	0	0	0	0	0	0	0	00
Parameter	No parameter.									
Description	This command is an empty command and it does not have any effect on the touch screen.									
Restriction	-									
Register Availability	<b>Status</b>					<b>Availability</b>				
	TS Sleep Out					Yes				
	TS Sleep In					Yes				
Default	<b>Status</b>					<b>Default value</b>				
	Power Up Sequence					N/A				
	TS S/W Reset					N/A				
	H/W Reset					N/A				
Flow Chart	-									

Himax Confidential  
Do Not Copy

13.2.2 TS sleep in (80h)

80 H	TSSLPIN (Touch Screen Sleep In)									
	DNC	D7	D6	D5	D4	D3	D2	D1	D0	HEX
Command	0	1	0	0	0	0	0	0	0	80
Parameter	No parameter									
Description	This command causes the touch screen to enter the minimum power consumption mode. MCU interface are register are still working and keeps their contents.									
Restriction	This command has no effect when the touch screen is already in TS Sleep In mode. TS Sleep In Mode can only be left by the TS Sleep Out Command (81h). It will be necessary to wait 5msec before sending next command. This is to allow time for the supply voltages and clock circuits to stabilize. It will be necessary to wait 5msec after sending TS Sleep Out command (when in TS Sleep In Mode) before TS Sleep In command can be sent.									
Register Availability	<b>Status</b>					<b>Availability</b>				
	TS Sleep Out					Yes				
	TS Sleep In					Yes				
Default	<b>Status</b>					<b>Default value</b>				
	Power Up Sequence					TS Sleep In Mode				
	TS S/W Reset					TS Sleep In Mode				
H/W Reset					TS Sleep In Mode					
Flow Chart	<pre> graph TD     TSSLPIN[Command] --&gt; StopDCDC[Stop DC/DC converter]     StopDCDC --&gt; StopOsc[Stop Internal Oscillator]     StopOsc --&gt; TSSleepIn[TS Sleep In Mode]     </pre>									

13.2.3 TS sleep out (81h)

81 H	TSSLPOUT (Touch Screen Sleep Out)									
	DNC	D7	D6	D5	D4	D3	D2	D1	D0	HEX
Command	0	1	0	0	0	0	0	0	1	81
Parameter	No parameter.									
Description	This command turns off TS Sleep In mode.									
Restriction	<p>This command has no effect when touch screen is already in TS Sleep Out mode. TS Sleep Out Mode can only be left by the TS Sleep In Command (80h). It will be necessary to wait 5msec before sending next command. This is to allow time for the supply voltages and clock circuits to stabilize.</p> <p>The touch screen loads all touch screen supplier's factory default values to the registers during this 5msec and there cannot be any abnormal effect on the touch screen functionality if factory default and register values are same when this load is done and when the touch screen is already TS Sleep Out – mode.</p> <p>It will be necessary to wait 5msec after sending TS Sleep In command (when in TS Sleep Out mode) before TS Sleep Out command can be sent.</p>									
Register Availability	<b>Status</b>					<b>Availability</b>				
	TS Sleep Out					Yes				
	TS Sleep In					Yes				
Default	<b>Status</b>					<b>Default value</b>				
	Power Up Sequence					TS Sleep In Mode				
	TS S/W Reset					TS Sleep In Mode				
	H/W Reset					TS Sleep In Mode				
Flow Chart	<pre> graph TD     A[TSSLPOUT] --&gt; B[Start Internal Oscillator]     B --&gt; C[Start up DC/DC converter]     C --&gt; D[TS Sleep Out Mode]     </pre>									

13.2.4 TS sense off (82h)

82 H	TSSOFF (Touch Screen Sense Off)									
	DNC	D7	D6	D5	D4	D3	D2	D1	D0	HEX
Command	0	1	0	0	0	0	0	1	0	82
Parameter	No parameter.									
Description	The touch screen is not sensing touches (= No new events), but the touch screen is still scanning.									
Restriction	-									
Register Availability	<b>Status</b>					<b>Availability</b>				
	TS Sleep Out					Yes				
	TS Sleep In					Yes				
Default	<b>Status</b>					<b>Default value</b>				
	Power Up Sequence					TS Sense Off				
	TS S/W Reset					TS Sense Off				
	H/W Reset					TS Sense Off				

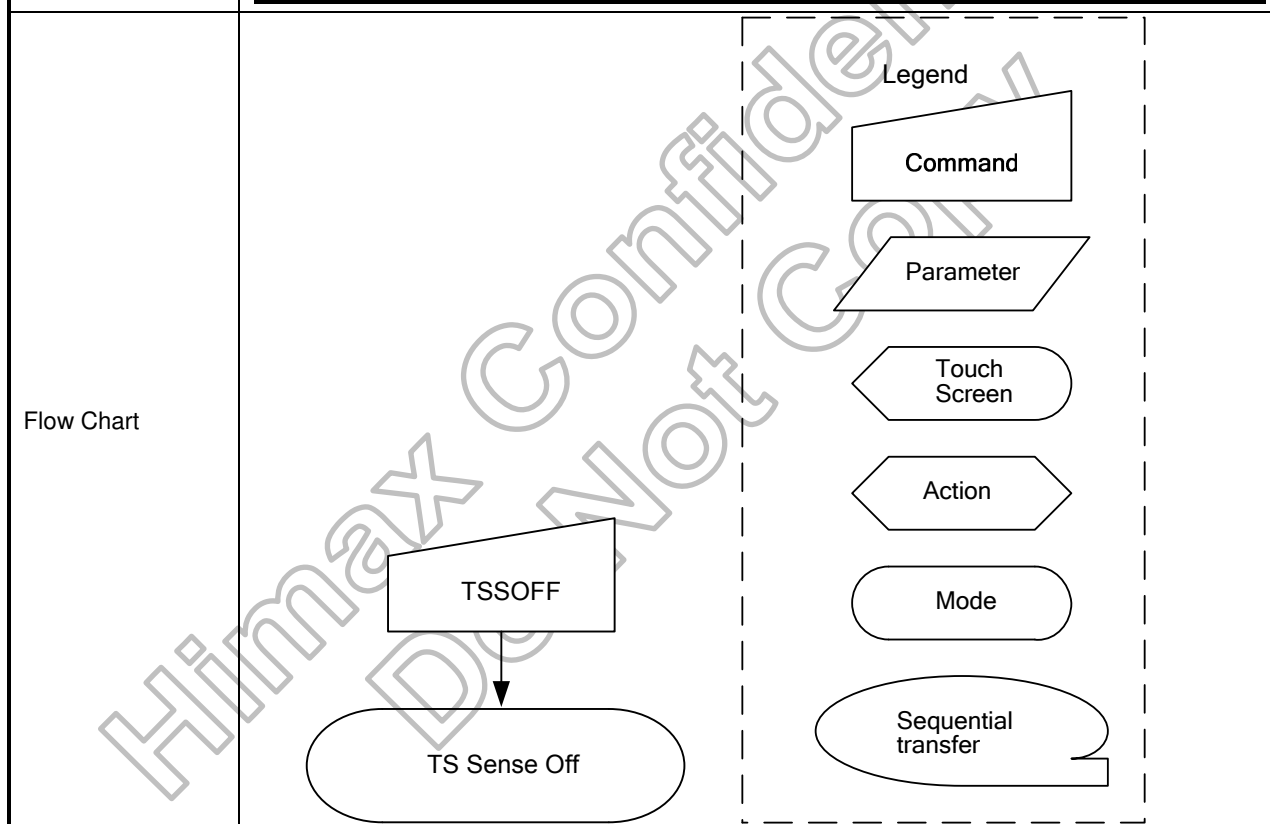

13.2.5 TS sense on (83h)

83 H	TSSON (Touch Screen Sense On)									
	DNC	D7	D6	D5	D4	D3	D2	D1	D0	HEX
Command	0	1	0	0	0	0	0	1	1	83
Parameter	No parameter.									
Description	The touch screen is sensing touches (= No new events).									
Restriction	-									
Register Availability	<b>Status</b>					<b>Availability</b>				
	TS Sleep Out					Yes				
	TS Sleep In					Yes				
Default	<b>Status</b>					<b>Default value</b>				
	Power Up Sequence					TS Sense Off				
	TS S/W Reset					TS Sense Off				
	H/W Reset					TS Sense Off				
Flow Chart	<pre> graph TD     TSSON[/TSSON/] --&gt; TS_Sense_On([TS Sense On])             </pre> <p>The flow chart illustrates the execution of the TSSON command. A trapezoidal command box labeled 'TSSON' has a downward arrow pointing to an oval-shaped 'TS Sense On' box. To the right, a dashed-line legend defines the symbols used: a trapezoid for 'Command', a parallelogram for 'Parameter', a rounded rectangle for 'Touch Screen', a hexagon for 'Action', an oval for 'Mode', and an oval with a tail for 'Sequential transfer'.</p>									

13.2.6 Read one event (85h)

85 H	ROE (Read One Event)															
	DNC	D7	D6	D5	D4	D3	D2	D1	D0	HEX						
Command	0	1	0	0	0	0	1	0	1	85						
1 <sup>st</sup> parameter	-	B31	B30	B29	B28	B27	B26	B25	B24	xx						
2 <sup>nd</sup> parameter	-	B23	B22	B21	B20	B19	B18	B17	B16	xx						
3 <sup>rd</sup> parameter	-	B15	B14	B13	B12	B11	B10	B9	B8	xx						
4 <sup>th</sup> parameter	-	B7	B6	B5	B4	B3	B2	B1	B0	xx						
Description	<p>This command returns touch co-ordinates what is the oldest co-ordinates information what has been stored on the stack. A returning value can be "No Event" if the stack is empty. The default assignment is list as below. The assignment of event stack also can be modified if necessary (base on the requirement of customer).</p> <p style="text-align: center;">HX852C-A Event stack</p> <div style="display: flex; align-items: center; justify-content: center;"> <table border="1" style="border-collapse: collapse; text-align: center;"> <tr><td>Yr (Low byte)</td></tr> <tr><td> </td></tr> <tr><td>Y- (Low byte)</td></tr> <tr><td>Y- (High byte)</td></tr> <tr><td>X- (Low byte)</td></tr> <tr><td>X- (High byte)</td></tr> </table> <div style="margin-left: 10px;">← Pointer</div> </div>										Yr (Low byte)		Y- (Low byte)	Y- (High byte)	X- (Low byte)	X- (High byte)
Yr (Low byte)																
Y- (Low byte)																
Y- (High byte)																
X- (Low byte)																
X- (High byte)																
Restriction	-															
Register Availability	<b>Status</b>					<b>Availability</b>										
	TS Sleep Out					Yes										
	TS Sleep In					Yes										
Default	<b>Status</b>					<b>Default value</b>										
	Power Up Sequence					0000 0000h										
	TS S/W Reset					0000 0000h										
	H/W Reset					0000 0000h										
Flow Chart	<div style="display: flex; justify-content: space-between;"> <div style="width: 60%;"> <pre> graph TD     subgraph Host         ROE[ROE]     end     subgraph Touch_Screen         P1[/Send 1st parameter/]         P2[/Send 2nd parameter/]         P3[/Send 3rd parameter/]         P4[/Send 4th parameter/]     end     ROE --&gt; P1     P1 --&gt; P2     P2 --&gt; P3     P3 --&gt; P4                     </pre> </div> <div style="width: 35%; border: 1px dashed black; padding: 5px;"> <p style="text-align: center;">Legend</p> <div style="display: flex; flex-direction: column; align-items: center;"> <div style="border: 1px solid black; padding: 5px; margin-bottom: 5px;">Command</div> <div style="border: 1px solid black; padding: 5px; margin-bottom: 5px;">Parameter</div> <div style="border: 1px solid black; padding: 5px; margin-bottom: 5px;">Touch Screen</div> <div style="border: 1px solid black; padding: 5px; margin-bottom: 5px;">Action</div> <div style="border: 1px solid black; padding: 5px; margin-bottom: 5px;">Mode</div> <div style="border: 1px solid black; padding: 5px; margin-bottom: 5px;">Sequential transfer</div> </div> </div> </div>															

13.2.7 Read all event (86h)

86 H	RAE (Read All Events)																	
	DNC	D7	D6	D5	D4	D3	D2	D1	D0	HEX								
Command	0	1	0	0	0	0	1	1	0	86								
1 <sup>st</sup> parameter	-	B7	B6	B5	B4	B3	B2	B1	B0	xx								
2 <sup>nd</sup> parameter	-	B15	B14	B13	B12	B11	B10	B9	B8	xx								
3 <sup>rd</sup> parameter	-	B23	B22	B21	B20	B19	B18	B17	B16	xx								
4 <sup>th</sup> parameter	-	B31	B30	B29	B28	B27	B26	B25	B24	xx								
5 <sup>th</sup> parameter	-	B39	B38	B37	B36	B35	B34	B33	B32	xx								
6 <sup>th</sup> parameter	-	B47	B46	B45	B44	B43	B42	B41	B40	xx								
:	-	:	:	:	:	:	:	:	:	:								
(n+1) <sup>th</sup> parameter	-	B(N)	B6 (n-1)	B6 (n-2)	B6 (n-3)	B6 (n-4)	B6 (n-5)	B6 (n-6)	B6 (n-7)	xx								
Description	<p>This command returns touch co-ordinates what is the oldest co-ordinates information what has been stored on the stock. A returning value can be "No Event" if the stock is empty. The default assignment is list as below. The assignment of event stack also can be modified if necessary (base on the requirement of customer).</p> <p style="text-align: center;">HX8520-A Event stack</p> <table border="1" style="margin-left: auto; margin-right: auto;"> <tr><td>Yn (Low byte)</td></tr> <tr><td>.</td></tr> <tr><td>Y1 (Low byte)</td></tr> <tr><td>Y1 (High byte)</td></tr> <tr><td>X1 (Low byte)</td></tr> <tr><td>X1 (High byte) ← Pointer</td></tr> </table>										Yn (Low byte)	.	Y1 (Low byte)	Y1 (High byte)	X1 (Low byte)	X1 (High byte) ← Pointer		
Yn (Low byte)																		
.																		
Y1 (Low byte)																		
Y1 (High byte)																		
X1 (Low byte)																		
X1 (High byte) ← Pointer																		
Restriction	This read command cannot use with LoSSI.																	
Register Availability	<table border="1" style="width: 100%;"> <thead> <tr> <th>Status</th> <th>Availability</th> </tr> </thead> <tbody> <tr> <td>TS Sleep Out</td> <td>Yes</td> </tr> <tr> <td>TS Sleep In</td> <td>Yes</td> </tr> </tbody> </table>					Status	Availability	TS Sleep Out	Yes	TS Sleep In	Yes							
Status	Availability																	
TS Sleep Out	Yes																	
TS Sleep In	Yes																	
Default	<table border="1" style="width: 100%;"> <thead> <tr> <th>Status</th> <th>Default value</th> </tr> </thead> <tbody> <tr> <td>Power Up Sequence</td> <td>All Values 0000 0000h</td> </tr> <tr> <td>TS S/W Reset</td> <td>All Values 0000 0000h</td> </tr> <tr> <td>H/W Reset</td> <td>All Values 0000 0000h</td> </tr> </tbody> </table>					Status	Default value	Power Up Sequence	All Values 0000 0000h	TS S/W Reset	All Values 0000 0000h	H/W Reset	All Values 0000 0000h					
Status	Default value																	
Power Up Sequence	All Values 0000 0000h																	
TS S/W Reset	All Values 0000 0000h																	
H/W Reset	All Values 0000 0000h																	
Flow Chart	<div style="display: flex; align-items: center;"> <div style="flex: 1;"> <p style="text-align: center;"><sup>2</sup>C Mode</p> <p style="text-align: center;">Read RAE</p> <p style="text-align: center;">↓</p> <p style="text-align: center;">Host</p> <hr style="border-top: 1px dashed black;"/> <p style="text-align: center;">Touch Screen</p> <p style="text-align: center;">Events</p> </div> <div style="flex: 1; border: 1px dashed black; padding: 5px;"> <p>Legend</p> <ul style="list-style-type: none"> <li>Command</li> <li>Parameter</li> <li>Touch Screen</li> <li>Actor</li> <li>Mode</li> <li>Sequential transfer</li> </ul> </div> </div>																	



13.2.8 Read latest event (87h)

87H	RLE (Read Latest Event)															
	DNC	D7	D6	D5	D4	D3	D2	D1	D0	HEX						
Command	0	1	0	0	0	0	1	1	1	87						
1 <sup>st</sup> parameter	-	B31	B30	B29	B28	B27	B26	B25	B24	xx						
2 <sup>nd</sup> parameter	-	B23	B22	B21	B20	B19	B18	B17	B16	xx						
3 <sup>rd</sup> parameter	-	B15	B14	B13	B12	B11	B10	B9	B8	xx						
4 <sup>th</sup> parameter	-	B7	B6	B5	B4	B3	B2	B1	B0	xx						
Description	<p>This command returns one touch event what is the latest co-ordinates information what has been stored on the stock. The event stack is empty after this command. A returning value can be "No Event" if the stock is empty. The default assignment is list as below. The assignment of event stack also can be modified if necessary (<b>base on the requirement of customer</b>).</p> <p style="text-align: center;">HX8520-A Event stack</p> <div style="text-align: center;"> <table border="1" style="margin-left: auto; margin-right: auto;"> <tr><td>Yn (Low byte)</td></tr> <tr><td>.</td></tr> <tr><td>Y1 (Low byte)</td></tr> <tr><td>Y1 (High byte)</td></tr> <tr><td>X1 (Low byte)</td></tr> <tr><td>X1 (High byte) ← Pointer</td></tr> </table> </div>										Yn (Low byte)	.	Y1 (Low byte)	Y1 (High byte)	X1 (Low byte)	X1 (High byte) ← Pointer
Yn (Low byte)																
.																
Y1 (Low byte)																
Y1 (High byte)																
X1 (Low byte)																
X1 (High byte) ← Pointer																
Restriction	-															
Register Availability	<b>Status</b>					<b>Availability</b>										
	TS Sleep Out					Yes										
	TS Sleep In					Yes										
Default	<b>Status</b>					<b>Default value</b>										
	Power Up Sequence					0000 0000h										
	TS S/W Reset					0000 0000h										
	H/W Reset					0000 0000h										
Flow Chart	<div style="display: flex; justify-content: space-between;"> <div style="width: 60%;"> <pre> graph TD     Host[Host] -- Read RLE --&gt; TS[Touch Screen]     subgraph TS         S1[/Senc 1<sup>st</sup> parameter/] --&gt; S2[/Senc 2<sup>nc</sup> parameter/]         S2 --&gt; S3[/Senc 3<sup>rd</sup> parameter/]         S3 --&gt; S4[/Senc 4<sup>th</sup> parameter/]     end             </pre> </div> <div style="width: 35%; border: 1px dashed black; padding: 5px;"> <p>Legend</p> <ul style="list-style-type: none"> <li>Command (Rectangle)</li> <li>Parameter (Parallelogram)</li> <li>Touch Screen (Hexagon)</li> <li>Action (Arrowhead)</li> <li>Mode (Oval)</li> <li>Sequential transfer (Loop)</li> </ul> </div> </div>															

13.2.9 Clear event stack (88h)

88 H	CLRES (Clear Event Stack)									
	DNC	D7	D6	D5	D4	D3	D2	D1	D0	HEX
Command	0	1	0	0	0	1	0	0	0	88
Parameter	No parameter.									
Description	This command clears event stack when the only return event can be "No Event".									
Restriction	-									
Register Availability	<b>Status</b>					<b>Availability</b>				
	TS Sleep Out					Yes				
	TS Sleep In					Yes				
Default	<b>Status</b>					<b>Default value</b>				
	Power Up Sequence					Empty Stack				
	TS S/W Reset					Empty Stack				
	H/W Reset					Empty Stack				
Flow Chart	<p>The flow chart illustrates the execution of the CLRES command. It starts with a trapezoidal symbol labeled 'CLRES', which points to an oval symbol labeled 'Clear Event Stack'. A legend on the right side of the chart defines the symbols used: Command (trapezoid), Parameter (parallelogram), Touch Screen (hexagon), Action (arrowhead), Mode (rounded rectangle), and Sequential transfer (oval with tail).</p>									

13.2.10 IC part number (D1h)

D1H	ID1 (IC Part Number)								HEX
	D7	D6	D5	D4	D3	D2	D1	D0	
Command	1	1	0	1	0	0	0	1	D1
1 <sup>st</sup> parameter	04								00..FF
2 <sup>nd</sup> parameter	85								00..FF
3 <sup>rd</sup> parameter	26								00..FF
Description	When the Device ID command is written, HX8528-C58 will echo the device ID to master. The index of IC part number command is D1h								
Register Availability	<b>Status</b>				<b>Availability</b>				
	TS Sleep Out				Yes				
	TS Sleep In				Yes				

Himax Confidential  
Do Not Copy

## 14. Reference circuit

### 14.1 HX8526-E30ADCG

Note: XRES voltage should be equal to +VCCD  
 TSIX does not need pull high  
 +VCCA = 2.7 to 3.6V  
 +VCCD = 1.65 to 3.6V

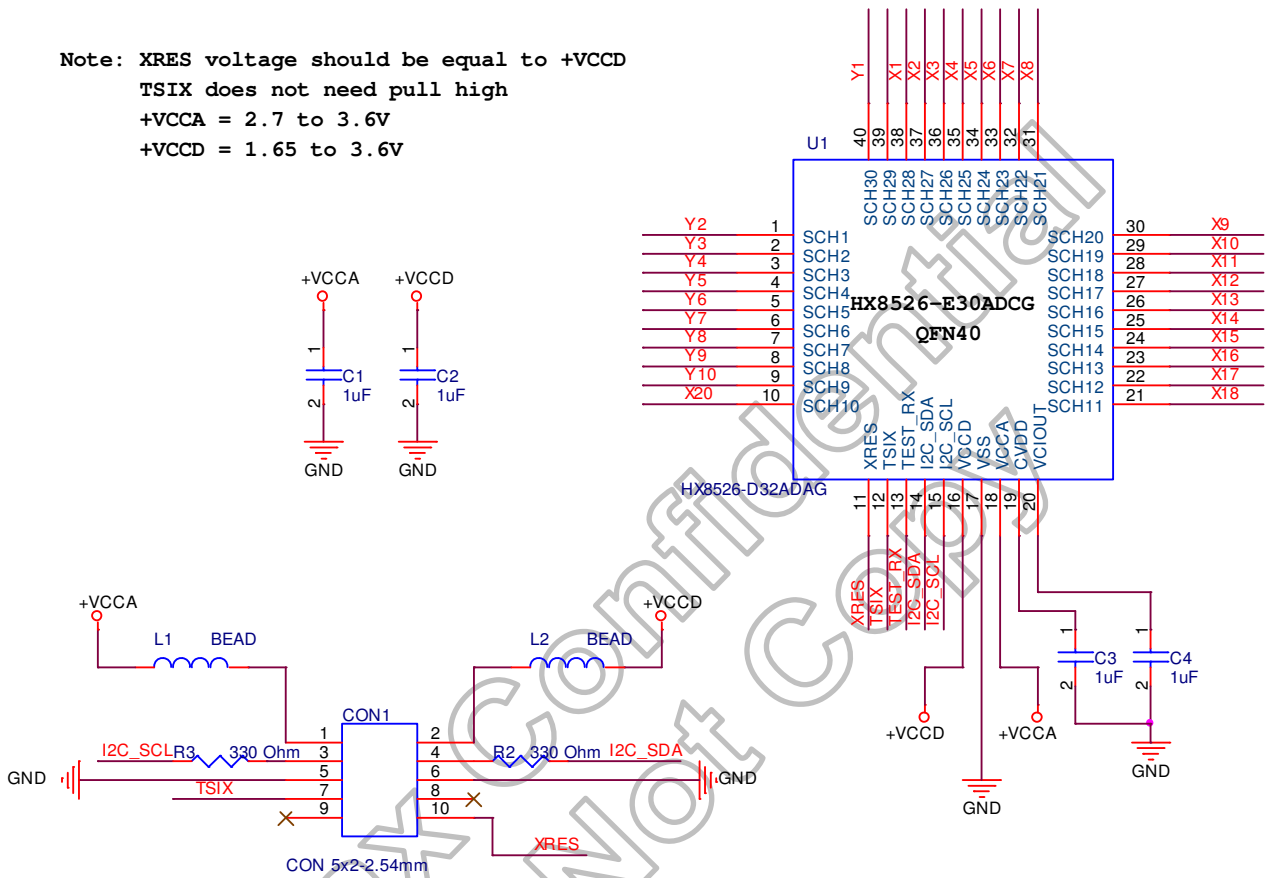

## 15. Ordering Information

Part no.	Package type
HX8526-E30ADCG	QFN 40 (5mmX5mmX0.65mm)

Himax Confidential  
Do Not Copy