

DM-LCD1602-427
1602 FSTN(+) CHARACTER LCD WITH
PARALLEL MPU INTERFACE

Contents

[Revision History](#)

[Main Features](#)

[Pin Description](#)

[Mechanical Drawing](#)

[Electrical Characteristics](#)

[Optical Characteristics](#)

[Block Diagram](#)

[Timing Character](#)

[Write data from MPU to ST7066U](#)

[Reading data from ST7066U to MPU](#)

[Instruction Table](#)

[Instruction Description](#)

[Initializing by Instruction](#)

[Built-in Font Table](#)

[Driver/Controller Information](#)

[Reliability](#)

[Warranty and Conditions](#)

1 Revision History

Date	Changes
2015-04-15	First release

2 Main Features

Item	Specification	Unit
Number of Characters	16 characters x 2 lines	
Display Mode	FSTN Positive, Transflective	-
Module dimension	122.0 x 44.0 x 13.6(MAX)	mm
Controller IC	ST7066U	-
Interface	6800 Series MPU Interface	-
Power Supply	5.0	V
View Direction	6:00	-
Duty	1/16	
Backlight	White LED	-
Weight	69.6	g

3 Pin Description

Pin No.	Symbol	Description
1	VSS	Ground
2	VDD	Supply Voltage for logic
3	VO	Operating voltage for LCD(Variable)
4	RS	H: DATA, L: Instruction code
5	R/W	H: Read(MPU→Module) L: Write(MPU→Module)
6	E	Chip enable signal
7	DB0	Data bus line
8	DB1	Data bus line
9	DB2	Data bus line
10	DB3	Data bus line
11	DB4	Data bus line
12	DB5	Data bus line
13	DB6	Data bus line
14	DB7	Data bus line
15	A	Power supply for B/L(+)
16	K	Power supply for B/L(-)

4 Mechanical Drawing

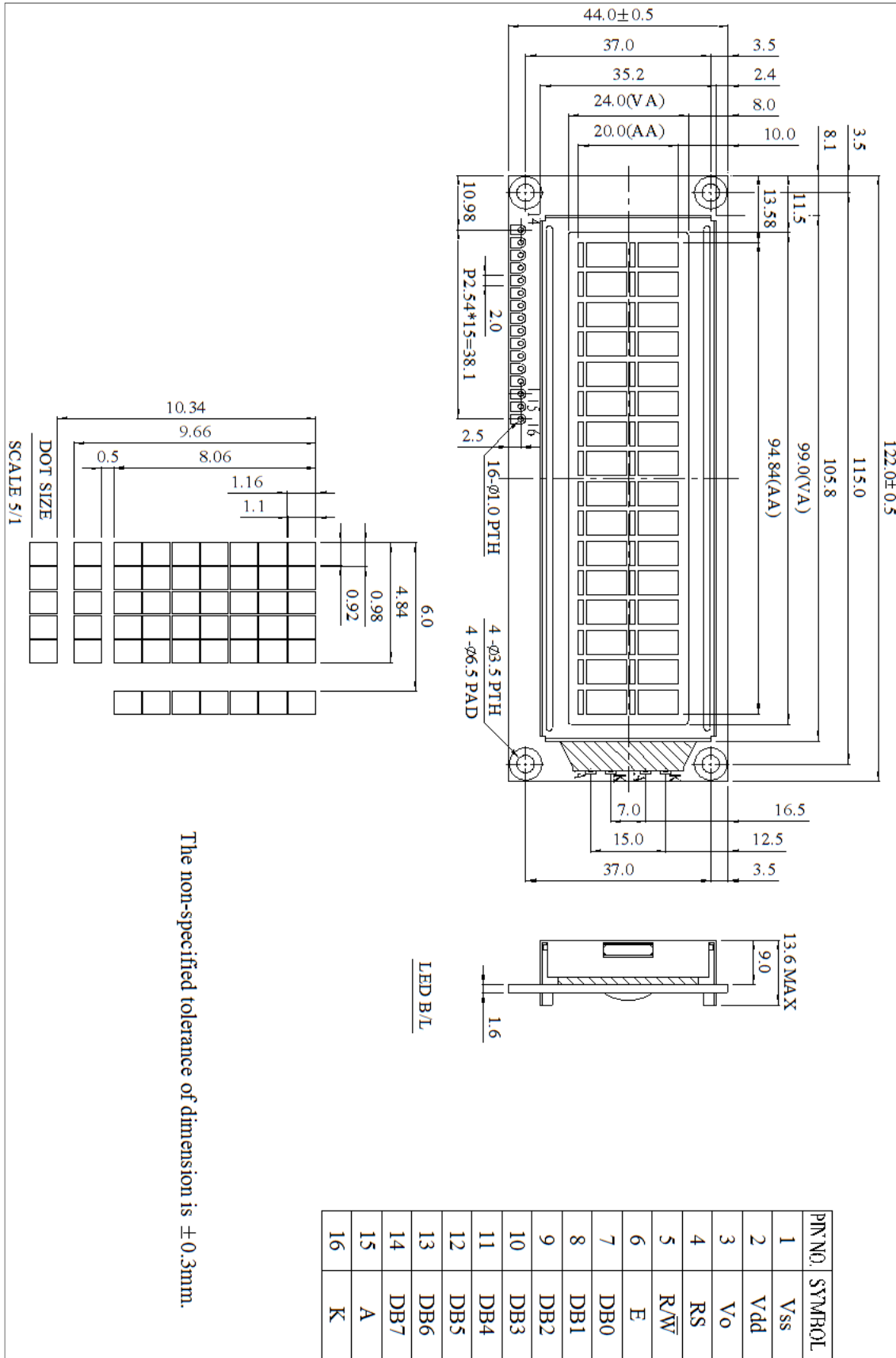

5 Electrical Characteristics

Item	Symbol	Condition	Min	Typ.	Max	Unit
Supply Voltage For Logic	VDD		4.5	5.0	5.5	V
Supply Current	IDD	VDD=5.0V	1.2	1.5	1.8	mA
Low Level Input Voltage	V _{IL}		VSS	-	0.6	V
High Level Input Voltage	V _{IH}		0.7VDD	-	VDD	V
Low Level Output Voltage	V _{OL}		0		0.4	V
High Level Output Voltage	V _{OH}		3.9		VDD	V
Backlight Supply Voltage	V		3.4	3.5	3.6	V
Backlight Supply Current	I _{LED}			48	60	mA
Operating Temperature	TOP	Absolute Max	-20	-	+70	°C
Storage Temperature	TST	Absolute Max	-30	-	+80	°C

6 Optical Characteristics

Item	Symbol	Min	Typ	Max	Unit	Note
View Angles Top	AV		30		°	
View Angles Bottom	AV		60		°	
View Angles Left	AH		45		°	
View Angles Right	AH		45		°	
Response Time (25°C)	Tr + Tf		300	400	ms	
Contrast Ratio	CR		5			
Luminance (Without LCD)	L _v	416	520		cd/m ²	

7 Block Diagram

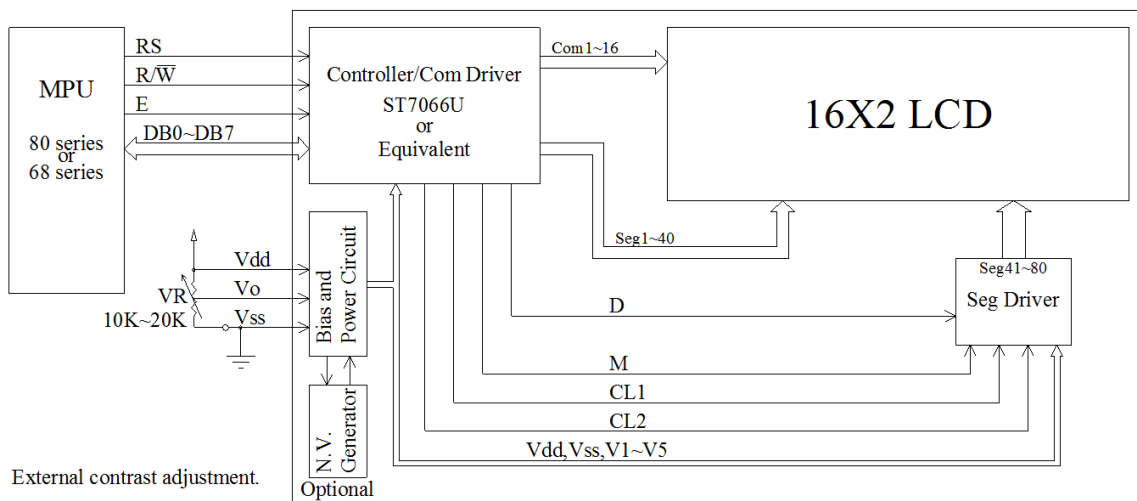

8 Timing Character

8.1 Write data from MPU to ST7066U

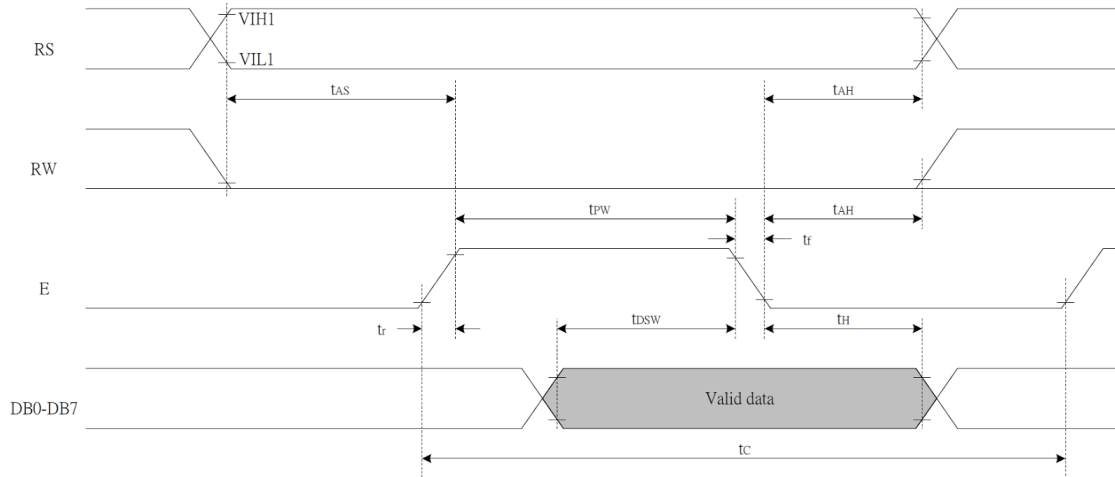

Symbol	Parameter	Min	Typ	Max	Unit
T_C	Enable Cycle Time	1200	-	-	ns
T_{PW}	Enable Pulse Width	140	-	-	ns
T_{R}, T_F	Enable Rise/Fall Time	-	-	25	ns
T_{AS}	Address Setup Time	0	-	-	ns
T_{AH}	Address Hold Time	10	-	-	ns
T_{DSW}	Data Setup Time	40	-	-	ns
T_H	Data Hold Time	10	-	-	ns

8.2 Reading data from ST7066U to MPU

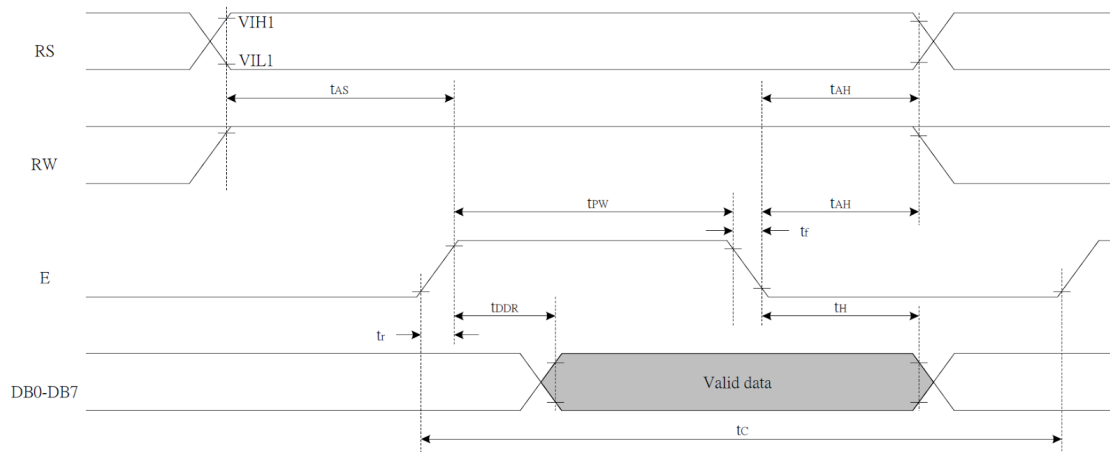

Symbol	Parameter	Min	Typ	Max	Unit
T_C	Enable Cycle Time	1200	-	-	ns
T_{PW}	Enable Pulse Width	140	-	-	ns
T_{R}, T_F	Enable Rise/Fall Time	-	-	25	ns
T_{AS}	Address Setup Time	0	-	-	ns
T_{AH}	Address Hold Time	10	-	-	ns
T_{DDR}	Data Setup Time	-	-	100	ns
T_H	Data Hold Time	10	-	-	ns

9 Instruction Table

Instruction	Instruction Code										Description	Description Time (270KHz)
	RS	R/W	DB7	DB6	DB5	DB4	DB3	DB2	DB1	DB0		
Clear Display	0	0	0	0	0	0	0	0	0	1	Write "20H" to DDRAM. and set DDRAM address to "00H" from AC	1.52 ms
Return Home	0	0	0	0	0	0	0	0	1	x	Set DDRAM address to "00H" from AC and return cursor to its original position if shifted. The contents of DDRAM are not changed.	1.52 ms
Entry Mode Set	0	0	0	0	0	0	0	1	I/D	S	Sets cursor move direction and specifies display shift. These operations are performed during data write and read.	37 us
Display ON/OFF	0	0	0	0	0	0	1	D	C	B	D=1:entire display on C=1:cursor on B=1:cursor position on	37 us
Cursor or Display Shift	0	0	0	0	0	1	S/C	R/L	x	x	Set cursor moving and display shift control bit, and the direction, without changing DDRAM data.	37 us
Function Set	0	0	0	0	1	DL	N	F	x	x	DL:interface data is 8/4 bits N:number of line is 2/1 F:font size is 5x11/5x8	37 us
Set CGRAM address	0	0	0	1	AC5	AC4	AC3	AC2	AC1	AC0	Set CGRAM address in address counter	37 us
Set DDRAM address	0	0	1	AC6	AC5	AC4	AC3	AC2	AC1	AC0	Set DDRAM address in address counter	37 us
Read Busy flag and address	0	1	BF	AC6	AC5	AC4	AC3	AC2	AC1	AC0	Whether during internal operation or not can be known by reading BF. The contents of address counter can also be read.	0 us
Write data to RAM	1	0	D7	D6	D5	D4	D3	D2	D1	D0	Write data into internal RAM (DDRAM/CGRAM)	37 us
Read data from RAM	1	1	D7	D6	D5	D4	D3	D2	D1	D0	Read data from internal RAM (DDRAM/CGRAM)	37 us

10 Instruction Description

Clear Display

	RS	RW	DB7	DB6	DB5	DB4	DB3	DB2	DB1	DB0
Code	0	0	0	0	0	0	0	0	0	1

Clear all the display data by writing "20H" (space code) to all DDRAM address, and set DDRAM address to "00H" into AC (address counter). Return cursor to the original status, namely, bring the cursor to the left edge on first line of the display. Make entry mode increment (I/D = "1").

Return Home

	RS	RW	DB7	DB6	DB5	DB4	DB3	DB2	DB1	DB0
Code	0	0	0	0	0	0	0	0	1	x

Return Home is cursor return home instruction. Set DDRAM address to "00H" into the address counter. Return cursor to its original site and return display to its original status, if shifted. Contents of DDRAM does not change.

Entry Mode Set

	RS	RW	DB7	DB6	DB5	DB4	DB3	DB2	DB1	DB0
Code	0	0	0	0	0	0	0	1	I/D	S

Set the moving direction of cursor and display.

I/D : Increment / decrement of DDRAM address (cursor or blink)

When I/D = "High", cursor/blink moves to right and DDRAM address is increased by 1.

When I/D = "Low", cursor/blink moves to left and DDRAM address is decreased by 1.

* CGRAM operates the same as DDRAM, when read from or write to CGRAM.

S: Shift of entire display

When DDRAM read (CGRAM read/write) operation or S = "Low", shift of entire display is not performed. If S = "High" and DDRAM write operation, shift of entire display is performed according to I/D value (I/D = "1" : shift left, I/D = "0" : shift right).

S	I/D	Description
H	H	Shift the display to the left
H	L	Shift the display to the right

Display ON/OFF

	RS	RW	DB7	DB6	DB5	DB4	DB3	DB2	DB1	DB0
Code	0	0	0	0	0	0	1	D	C	B

Control display/cursor/blink ON/OFF 1 bit register.

D : Display ON/OFF control bit

When D = "High", entire display is turned on.

When D = "Low", display is turned off, but display data is remained in DDRAM.

C : Cursor ON/OFF control bit

When C = "High", cursor is turned on.

When C = "Low", cursor is disappeared in current display, but I/D register remains its data.

B : Cursor Blink ON/OFF control bit

When B = "High", cursor blink is on, that performs alternate between all the high data and display character at the cursor position.

When B = "Low", blink is off.

Cursor or Display Shift

RS RW DB7 DB6 DB5 DB4 DB3 DB2 DB1 DB0

Code	0	0	0	0	0	1	S/C	R/L	x	x
------	---	---	---	---	---	---	-----	-----	---	---

Without writing or reading of display data, shift right/left cursor position or display. This instruction is used to correct or search display data. During 2-line mode display, cursor moves to the 2nd line after 40th digit of 1st line. Note that display shift is performed simultaneously in all the line. When displayed data is shifted repeatedly, each line shifted individually. When display shift is performed, the contents of address counter are not changed.

S/C	R/L	Description	AC Value
L	L	Shift cursor to the left	AC=AC-1
L	H	Shift cursor to the right	AC=AC+1
H	L	Shift display to the left. Cursor follows the display shift	AC=AC
H	H	Shift display to the right. Cursor follows the display shift	AC=AC

Function Set

RS RW DB7 DB6 DB5 DB4 DB3 DB2 DB1 DB0

Code	0	0	0	0	1	DL	N	F	x	x
------	---	---	---	---	---	----	---	---	---	---

DL : Interface data length control bit

When DL = "High", it means 8-bit bus mode with MPU.

When DL = "Low", it means 4-bit bus mode with MPU. So to speak, DL is a signal to select 8-bit or 4-bit bus mode.

When 4-bit bus mode, it needs to transfer 4-bit data by two times.

N : Display line number control bit

When N = "Low", it means 1-line display mode.

When N = "High", 2-line display mode is set.

F : Display font type control bit

When F = "Low", it means 5 x 8 dots format display mode

When F = "High", 5 x 11 dots format display mode.

N	F	No. of Display Lines	Character Font	Duty Factor
L	L	1	5 x 8	1/8
L	H	1	5 x 11	1/11
H	x	2	5 x 8	1/16

Set CGRAM Address

RS RW DB7 DB6 DB5 DB4 DB3 DB2 DB1 DB0

Code	0	0	0	1	AC5	AC4	AC3	AC2	AC1	AC0
------	---	---	---	---	-----	-----	-----	-----	-----	-----

Set CGRAM address to AC.

This instruction makes CGRAM data available from MPU

Set DDRAM Address

RS RW DB7 DB6 DB5 DB4 DB3 DB2 DB1 DB0

Code	0	0	1	AC6	AC5	AC4	AC3	AC2	AC1	AC0
------	---	---	---	-----	-----	-----	-----	-----	-----	-----

Set DDRAM address to AC.

This instruction makes DDRAM data available from MPU.

When 1-line display mode (N = 0), DDRAM address is from "00H" to "4FH".

In 2-line display mode (N = 1), DDRAM address in the 1st line is from "00H" to "27H", and DDRAM address in the 2nd line is from "40H" to "67H".

Read Busy Flag and Address

RS RW DB7 DB6 DB5 DB4 DB3 DB2 DB1 DB0

Code	0	1	BF	AC6	AC5	AC4	AC3	AC2	AC1	AC0
------	---	---	----	-----	-----	-----	-----	-----	-----	-----

When BF = "High", indicates that the internal operation is being processed. So during this time the next instruction cannot be accepted.

The address Counter (AC) stores DDRAM/CGRAM addresses, transferred from IR.

After writing into (reading from) DDRAM/CGRAM, AC is automatically increased (decreased) by 1.

Write Data to CGRAM or DDRAM

RS RW DB7 DB6 DB5 DB4 DB3 DB2 DB1 DB0

Code	1	0	D7	D6	D5	D4	D3	D2	D1	D0
------	---	---	----	----	----	----	----	----	----	----

Write binary 8-bit data to DDRAM/CGRAM.

The selection of RAM from DDRAM, CGRAM, is set by the previous address set instruction: DDRAM address set, CGRAM address set. RAM set instruction can also determine the AC direction to RAM.

After write operation, the address is automatically increased/decreased by 1, according to the entry mode.

Read Data from CGRAM or DDRAM

RS RW DB7 DB6 DB5 DB4 DB3 DB2 DB1 DB0

Code	1	1	D7	D6	D5	D4	D3	D2	D1	D0
------	---	---	----	----	----	----	----	----	----	----

Read binary 8-bit data from DDRAM/CGRAM.

The selection of RAM is set by the previous address set instruction. If address set instruction of RAM is not performed before this instruction, the data that read first is invalid, because the direction of AC is not determined. If you read RAM data several times without RAM address set instruction before read operation, you can get correct RAM data from the second, but the first data would be incorrect, because there is no time margin to transfer RAM data.

In case of DDRAM read operation, cursor shift instruction plays the same role as DDRAM address set instruction: it also transfer RAM data to output data register. After read operation address counter is automatically increased/decreased by 1 according to the entry mode. After CGRAM read operation, display shift may not be executed correctly.

* In case of RAM write operation, after this AC is increased/decreased by 1 like read operation. In this time, AC indicates the next address position, but you can read only the previous data by read instruction.

11 Initializing by Instruction

8-bit Interface(focs=270KHz)

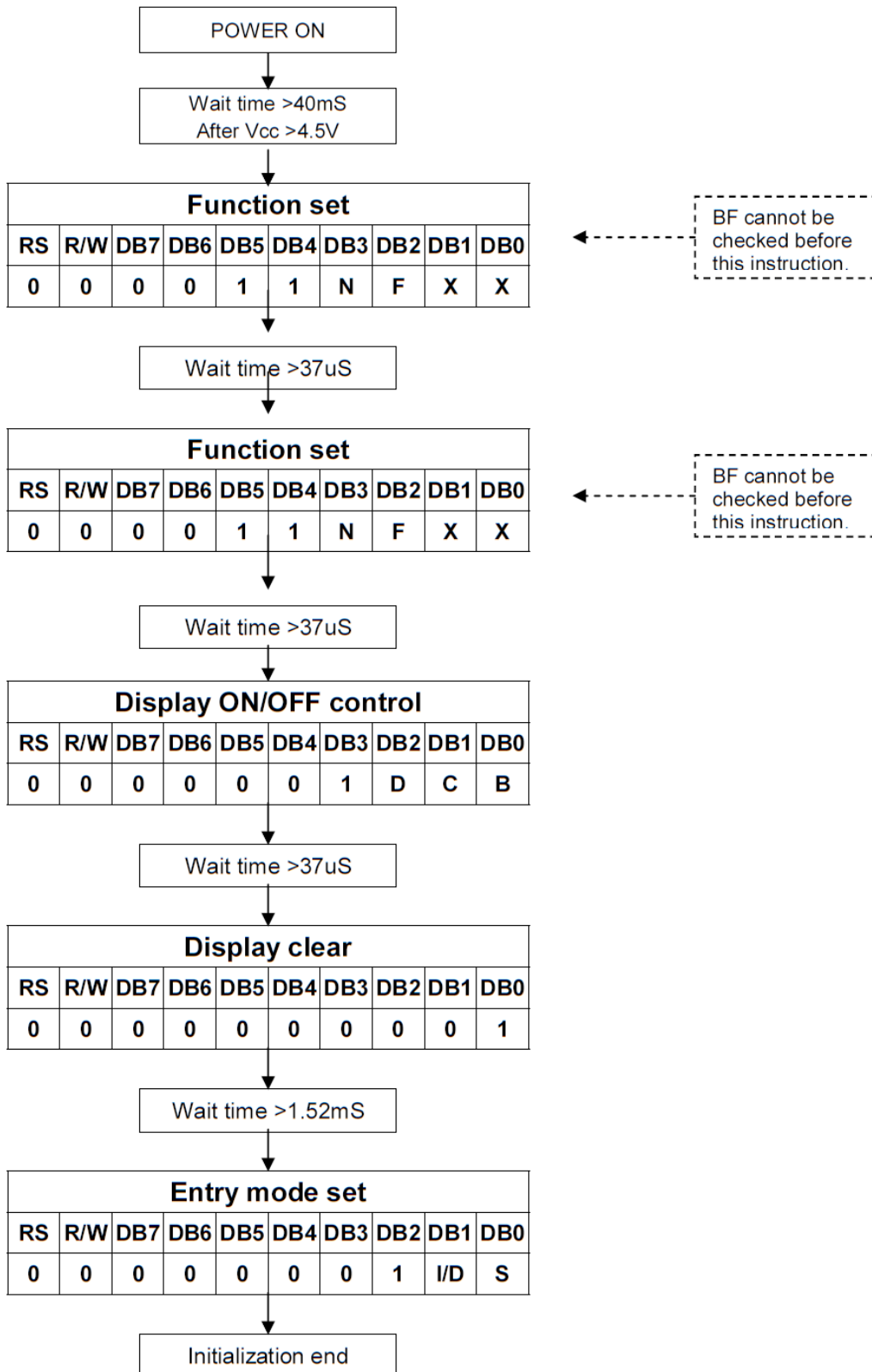

4-bit Interface (fosc=270KHz)

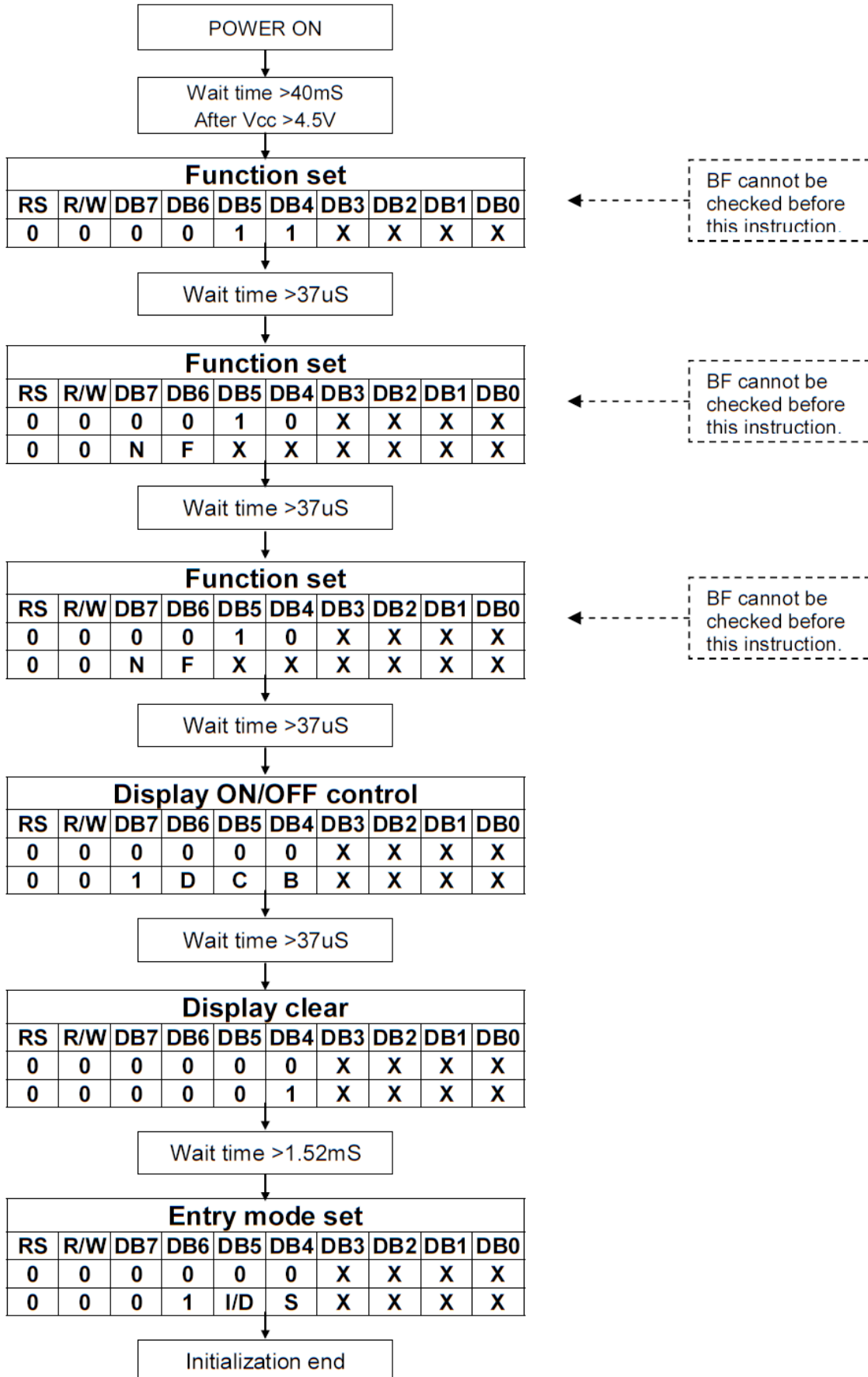

12 Built-in Font Table

Upper 4 bit Lower 4 bit	LLLL	LLLH	LLHL	LLHH	LHLL	LHLH	LHHL	LHHH	HLLL	HLLH	HLHL	HLHH	HHLL	HHLH	HHHL	HHHH
LLLL	CG RAM (1)			0	1	2	3	4	5	6	7	8	9	A	B	C
LLLH	(2)	!	@"	#	\$	%	&	'	()	*	+	,	-	.	/
LLHL	(3)	:"	{		~											
LLHH	(4)															
LHLL	(5)								¡	¢	£	¤	¥	¦	§	¨
LHLH	(6)	©	ª	«	¬	­	®	¯	°	±	²	³	´	µ	¶	·
LHHL	(7)	¸									¡	¢	£	¤	¥	¦
LHHH	(8)	§	¨	©	ª	«	¬	­	®	¯	°	±	²	³	´	µ
HLLL	(1)	¸									¡	¢	£	¤	¥	¦
HLLH	(2)	§	¨	©	ª	«	¬	­	®	¯	°	±	²	³	´	µ
HLHL	(3)	¸									¡	¢	£	¤	¥	¦
HLHH	(4)	§	¨	©	ª	«	¬	­	®	¯	°	±	²	³	´	µ
HHLL	(5)	¸									¡	¢	£	¤	¥	¦
HHLH	(6)	§	¨	©	ª	«	¬	­	®	¯	°	±	²	³	´	µ
HHHL	(7)	¸									¡	¢	£	¤	¥	¦
HHHH	(8)	§	¨	©	ª	«	¬	­	®	¯	°	±	²	³	´	µ

13 Driver/Controller Information

Built-in ST7066U IC

<https://drive.google.com/file/d/0B0U8oRNrY9XuN0I0WWWsRk5DR0k/view?usp=sharing>

14 Reliability

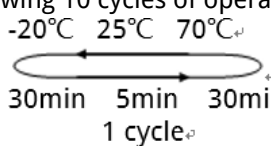
Test Item	Content of Test	Test Condition	Note
High Temperature Storage	Endurance test applying the high storage temperature for a long time.	80°C 200hrs	2
Low Temperature Storage	Endurance test applying the high storage temperature for a long time.	-30°C 200hrs	1,2
High Temperature Operation	Endurance test applying the electric stress (Voltage & Current) and the thermal stress to the element for a long time.	70°C 200hrs	-
Low Temperature Operation	Endurance test applying the electric stress under low temperature for a long time.	-20 °C 200hrs	1
High Temperature/ Humidity Operation	The module should be allowed to stand at 60°C,90%RH max, for 96hrs under no-load condition excluding the polarizer. Then taking it out and drying it at normal temperature.	60°C,90%RH 96hrs	1,2
Thermal Shock Resistance	The sample should be allowed stand the following 10 cycles of operation. 	-20°C/70°C 10 cycles	-
Vibration Test	Endurance test applying the vibration during transportation and using.	Total fixed amplitude: 15mm; Vibration: 10~55Hz; One cycle 60 seconds to 3 directions of X, Y, Z, for each 16 minutes.	3
Static Electricity Test	Endurance test apply the electric stress to the terminal.	VS=800V, RS=1.5kΩ, CS=100pF, 1 time.	-

Note1: No dew condensation to be observed.

Note2: The function test shall be conducted after 4 hours storage at the normal. Temperature and humidity after remove from the rest chamber.

Note3: Test performed on product itself, not inside a container

15 Warranty and Conditions

<http://www.displaymodule.com/pages/faq>