

# **ZygologySystems**

*Labels and Labelling Solutions*

*Your premier*



*distributor*

Speak to a labelling expert today!

Call: 01628 520 440

Email: [sales@zygology.co.uk](mailto:sales@zygology.co.uk)

Visit: [www.zygology.co.uk](http://www.zygology.co.uk)



## Solutions for hazardous energy control

Lockout / Tagout

# About BRADY



Once you have worked with BRADY, our name will stick with you, (just like our labels) because BRADY is one of the world's leading labelling and identification specialists.

## Innovative

At BRADY we continue to improve. We have many customers from all industries, and we strive to be ahead of their needs by continuing to invest in research for even more performant solutions. By developing more user-friendly and efficient concepts, we give our thousands of customers the best in the market.

## Strength

At BRADY, we believe our biggest strength is the wide range of identification and safety solutions we can offer our customers, whether it's labelling the smallest component or complete signage for an entire warehouse. We're also proud to offer many products and services - from printers, scanners and software to service contracts and on-site training - that compliment any identification job. And don't forget, our wide network of expert distributors can always offer you a tailor-made solution to meet your specific requirements.

## Trust

For over a hundred years, BRADY has been connected with quality, trust and stability. We demand the best for your products and services, because we know, better than anyone, the importance of good and reliable identification. Identification looks like a small detail, but every professional knows that this kind of detail is crucial to any business.

## Inform

We also have specialised dealers in your region, who can answer all your identification, safety and labelling questions, specific to your activity. They will be happy to provide you with all kinds of options and solutions with no obligation.

Microsoft is a trademark of Microsoft Corporation, Bluetooth is a trademark of Bluetooth Sig, Inc., Android is a trademark of Google Inc.



Brady products are sold on the condition that the purchaser will test them in actual use and determine for himself/herself their suitability to his/her intended purpose. Brady warrants to the purchaser that Brady products are free from defects in material and workmanship but limits its obligation under this warranty to the replacement of the product which has been shown to Brady's satisfaction to have been defective at the time of its purchase.

The warranty does not extend to any persons who have acquired the product from the purchaser. It is in lieu of any other warranty, including every warranty of sale-ability, marketability or suitability for the intended purpose, and is also in lieu of any other obligation or liability on the part of Brady.

Under no circumstances will Brady be liable for losses, damage, costs or subsequent damage of whatever nature which may arise in connection with the use of, or inability to use, Brady's products.

# Lockout / Tagout

## Solutions for hazardous energy control

### The Brady Advantage

When it comes to identification, safety and compliance, there's a clear advantage to working with Brady. We put our customers first in everything we do.

Our goal is to give you an unrivalled customer experience. We are relentlessly committed to performance and excellence - in our products, services and people.

Our products and solutions perform in ways that others simply can't match. Our people perform in ways that regularly exceed your expectations. And our focus and discipline work toward solid, long-term performance for our customers.

In short, Brady is the company you trust when performance matters most.

**Learn more about the Brady Advantage at: [www.bradyeurope.com](http://www.bradyeurope.com)**

### Contents

- 5 Why and how to implement a lockout/tagout programme
- 15 Padlocks
- 37 Lock boxes and padlock centres
- 43 Lockout devices
  - 44 Cable lockout devices
  - 47 Universal valve lockout
  - 48 Ball valve lockouts
  - 49 Gate valve lockouts
  - 51 Butterfly valve lockouts
  - 52 Pipe blind lockout
  - 53 Gas and airline lockouts
  - 54 Electrical risk
  - 62 Confined space safety covers
- 63 Hasps, kits, bags, stations, tags, labels and printers
  - 64 Hasps
  - 67 Lockout kits
  - 72 Lockout pouches & bags
  - 74 Lockout stations & boards
  - 76 Tagout
- 88 Breaker compatibility overview





**Do not operate**  
without a Lockout/  
Tagout programme

“A co-worker dies, and 160 others have a work-related accident, every 15 seconds. (International Labour Organisation, 2015)

Workplaces claim more than 2.3 million deaths per year, including 350,000 fatal accidents and close to 2 million life ending work-related diseases.

In addition, 313 million accidents happen on the job every year, 268 million of those resulting in at least 3 days absence from work. ILO estimates the cost of work accidents & professional diseases indemnities and absences to 4% of the world GDP.

Workplace accidents not only impact companies (Figure 1) but also people’s lives and the overall health of the available workforce. (Figure 2)

**Figure 1: Economic effects of safety and health at company level**

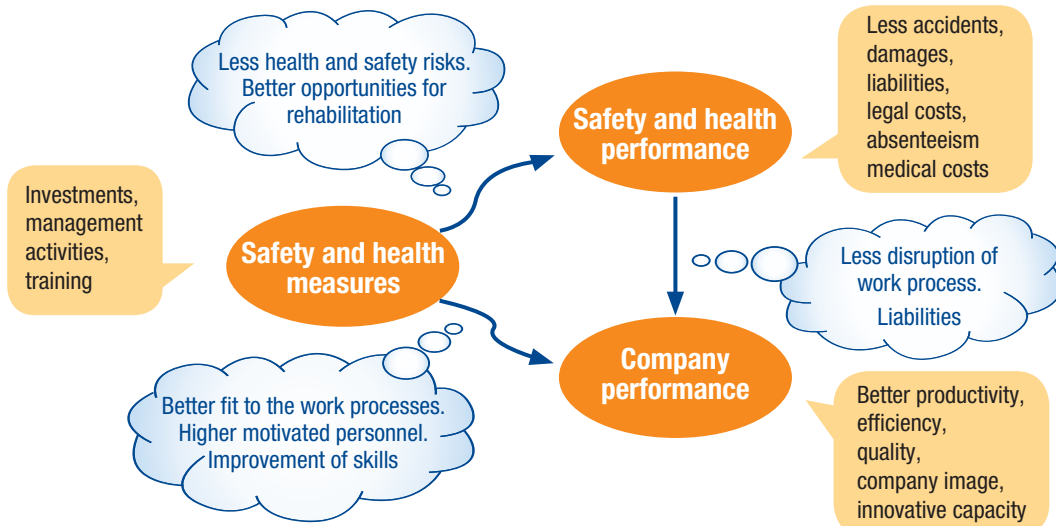

**Figure 2: Work accidents inflict costs on many parties (adapted from Krüger, 1997)**



Source: Inventory of socioeconomic costs of work accidents, Joss Mossnik, Marc de Greef, 2002

Throughout the world, companies are starting to meet the workplace safety challenge with intensive ‘Go for Zero’-strategies, expressing their unwavering ambition to reduce workplace accidents. Brady, a worldwide manufacturer and supplier of Safety Solutions, supports ‘Go for Zero’-strategies with a broad range of quality products, including on-site printable safety signage, custom signs, pipe markers, spill control and Lockout/Tagout.

**In this brochure, you can look through our solutions for maintenance related accident prevention. Solutions related to other activities can be found in our other safety solutions brochures.**



## Why and how to implement a lockout/tagout programme

Use this reference guide to gain a better understanding of Lockout/Tagout procedures. More in-depth information regarding padlocks, lockout devices and tags can be found throughout the catalogue.

- 6 What is lockout/tagout & why work with Brady?
- 6 Lockout/tagout - global best practice training movie
- 7 Why implement a lockout/tagout programme?
- 7 Brady's complete LO/TO solution
- 8 Efficient lockout programme in 4 steps
- 10 Respecting legal requirements
- 11 ATEX certification
- 12 Safety software & services
- 14 Effective control of hazardous energy
- 14 Hazardous energies where LO/TO is ideal means of control



## What is lockout/tagout?

Lockout / Tagout is a planned safety procedure which involves turning off the energy supply of industrial machinery and equipment whilst maintenance work or repairs are being carried out. This procedure protects workers from the risks posed by live machinery or electricity.

## LO/TO SAVES LIVES!



## Why work with Brady?

**Brady is the global leader in Lockout/Tagout solutions.**

Brady was the first to respond to the new OSHA legislation in the U.S. in 1990, and has maintained its position as a leading Lockout solutions provider ever since. Today, Brady offers a comprehensive package for Lockout/Tagout compliance. Increasing demand for advanced safety solutions in Europe and MEA countries has driven our R&D as well as know-how to become the best-in-class LO/TO complete solution provider.

## Lockout/tagout - global best practice training movie

This instructional programme is designed to inform and train organisational safety leaders, as well as employees who may be exposed to hazardous equipment energies. It will help employers to develop and improve their company's Lockout / Tagout programme. It is also extremely beneficial for all employees who shut down and service equipment, instructing them how to avoid accidents and remain safe on the job.

### Highly comprehensive content

The product's composition is as follows:

- The Movie
- A Quick Start Guide
- An Instructor's Guide
- An Employee Quiz

The Employee quiz can be used at the end of the training programme. It allows to test the employee's knowledge after the training session and facilitates a discussion. A padlock engraved "LOTO saves lives" is included in the product box.

All parts are available electronically on a USB key (Quick Start is also available in a hard copy format), and accessible in 10 different languages for EMEA: English, French, German, Dutch, Spanish, Italian, Portuguese, Turkish, Polish and Russian.

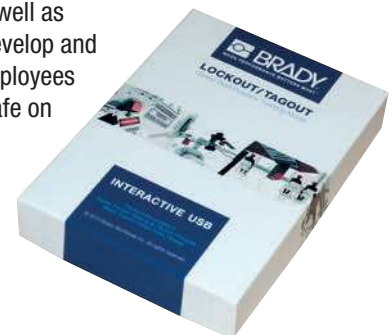

| Order Reference | Description  |
|-----------------|--|
| 833918          | Lockout / Tagout – Global Best Practice Training Movie. Reduce work accidents! |

## Why implement a lockout/tagout programme?

### Reduced accident rates and injury costs

EU Figures show that 10 to 15% of all fatal accidents at work and 15 to 20% of all accidents are connected with maintenance. Common injuries include fractures, lacerations, amputations, burns and shocks. Due to the serious nature of many LO/TO accidents, injury-related costs can be exorbitant.



### Less downtime, higher productivity

A well-organised LO/TO programme that includes clearly labelled energy sources, easy-to-follow procedures, and readily accessible lockout tools can greatly speed up maintenance and servicing activities. Workers can avoid time-consuming tasks such as tracing pipelines and electrical circuits in order to verify the appropriate energy control points. As a result, maintenance work is completed more efficiently, downtime is reduced and machinery is kept running at peak performance levels.



### Reduced indirect costs

Accidents can have a significant impact on work scheduling and productivity at the affected job site. The unexpected start up of equipment can also cause extensive damage to the machinery itself, adding the expense of equipment repairs and replacement to the total cost involved.



### Best Safety Practice

Lockout / Tagout has become globally recognised as Best Safety Practice for many industries and is a legal requirement in the US.



## Brady's complete LO/TO solution

Complete attitude to effective energy control via audit, identification of energy points, selection and purchasing of proper devices, elaboration of instructions, training and implementation.







## Efficient lockout programme in 4 Steps

Follow the BEST GLOBAL PRACTICE plan for creating an efficient lockout programme:



### 1 Create energy control (LO/TO) policy & procedures

The first step is to develop and document a lockout policy that identifies in detail the purpose and scope of the lockout programme. We can help you to create a roadmap for the successful LO/TO programme implementation, where you need to execute an audit of all existing potential sources of hazardous energy, create a list, describe procedures and define responsibilities.

#### Why do you need lockout procedures

- Procedures serve as a check sheet to help employees avoid mistakes and reduce the risk of accidents and injuries.
- Procedures speed lockout activity, which in turn reduces downtime and improves operational productivity.
- Documented machine-specific energy control procedures are required by OSHA.



#### TIP: LO/TO policy should include:

- ✓ Purpose and scope
- ✓ Authorised personnel
- ✓ Enforcement policy
- ✓ Training methods
- ✓ Address special circumstances such as group lockout, shift transfer etc.



### 2 Identify all energy control points

In this step you need to localise and clearly mark all energy control points, including valves, switches, breakers and plugs, with permanently placed labels or tags. Our label makers and Do-it-Yourself Signmarking printing systems together with durable label materials are designed to provide you with reliable and long-lasting identification.



**BradyPrinter S3100**  
SIGN & LABEL PRINTER

**BBP 35**  
MULTICOLOUR LABEL PRINTER  
**BBP 37**  
MULTICOLOUR & CUT LABEL PRINTER

**BBP 85**  
LABEL PRINTER

**BradyJet J5000**  
COLOR LABEL PRINTER



## Efficient lockout programme in 4 Steps

Follow the BEST GLOBAL PRACTICE plan for creating an efficient lockout programme:

### 3 Equip authorised employees with the proper lockout tools and warning devices

Brady offers a comprehensive line of LO/TO devices and tools - Padlocks include safety, non-conductive, brass, Lockouts include Valve, Universal and Circuit breakers, Tags, Labels, Lockout Boxes, Padlock Stations and much more!



### 4 Train employees and promote awareness of safe work practices

Brady offers its expertise in training employees and supervisors. We can prepare a fair plan for training sessions, define the required content for a particular audience and train your supervisory staff to be able to perform internal training.



Keep in mind all the people in your facility, recognise 3 groups with different needs of awareness degree:

|                     |   |  |
|---------------------|---|--|
| Authorised employee | → A person who locks out or tags out machines or equipment in order to perform servicing or maintenance and identifies that equipment have a source(s) of energy that can cause injury to the employee. | → Requires the most in-depth training about LO/TO.                                 |
| Affected employee   | → An employee whose job requires him/her to operate or use a machine or equipment on which servicing or maintenance is being performed under LO/TO, or whose job requires him/her to work in the area.  | → Needs to be informed about LO/TO and does not attempt to remove lockout devices. |
| Other employees     | → Who may encounter lockout being implemented.  | → Need to know the significance of lockout, and to keep away.                      |



#### Do not forget about different circumstances:

- Shift changes
- Outside contractors & outsourced maintenance

## Respecting legal requirements



### Europe

Directive 2009/104/EC (formerly directive 89/655/EEC of the Council from 30 November 1989) specify the minimum requirements for safety and health protection for workers using work equipment at work. Paragraph 2.14 lays down that “every piece of equipment must be fitted with clearly visible devices with which it can be separated from every energy source”. Paragraph 2.15. lays down that “Work equipment must bear the warnings and markings essential to ensure the safety of workers”.

EN ISO 14118 (2018-07) norm of Safety of machinery (is the successor to DIN EN 1037 2008-11) related to the equipment’s safety defines the measures regarding the energy isolation of machinery and the power dissipation to prevent hazardous equipment re-energising. It assures a safe and secure intervention within a risk-prone area.



### Austria

AschG – ArbeitnehmerInnenschutzgesetz – Federal Act on Occupational Health and Safety

AM-VO – Arbeitsmittelverordnung (Ordinance on Work Equipment and Tools) – Regulation of the Federal Ministry of Commerce and Labour on protection of employees while using work equipment paragraph 1, §17 (1).



### France

UTE C18-510 (electrical applications): Lockout of apparatus for service and maintenance to lockout equipment is to carry out the necessary procedures to ensure that the equipment is placed and maintained in a safe position; to prevent its activation and label that the isolated equipment must not be operated. The employer must ensure that all safety procedures are strictly implemented and regularly reviewed by appropriate means. Employees must use all necessary tools to carry out maintenance.

Best practice document developed by INRS (Institut National de Recherche et de Sécurité) in November 2011: ED 6109

- Décret 2010-1016 refers to the obligations of the employers for temporary or permanent electrical installations usage
- Labour code (article R4215-10) refers to the identification of the conductors
- Décret 2010-1018 refers to the prevention of electrical risks in work environment, décret 2010-2118 refers to the operations done on electrical installations.
- Labour code (article R 4544-5): the part of the installation on which work (de-energised) is done must be identified and locked.
- Arrêté of April 26, 2012: Every operation on electrical equipment must follow the new norm NF C 18-510. Article 1 says that this norm is now included into the French Code of Labour.



### Germany

BetrSichV 2015 (Ordinance on Industrial Safety and Health)

Ordinance concerning the protection of safety and health in the provision of work equipment and its use at work and maintenance processes.

Extract from BetrSichV 2015

§ 8 Protective measures in case of hazards caused by energies, start-up and stoppage

Paragraph 3: “Command devices which have an influence on the safe use of the means of work shall in particular be secured against unintended or unauthorised operation.

Paragraph 4: “Work equipment may only be intentionally put into operation. If necessary, the start-up process must be safely prevented.

§ 10 Maintenance and modification of work equipment

Paragraph 3: The employer must take all necessary measures to ensure that maintenance work can be carried out safely.

(3) to secure the working area during the maintenance work

(6) to avoid hazards caused by moving raised work equipment or parts thereof, as well as by hazardous energies or substances.

(9) Provide necessary warnings and dangers messages referring to maintenance work on the work equipment

Paragraph 4: Where, in the case of maintenance activities ... are carried out under the threat of energy, the safety of workers shall be ensured during the duration of this work by means of other appropriate measures.



### Italy

The Italian legislation (Direttiva 2001/45/CE del Parlamento europeo e del Consiglio del 27 giugno 2001 che modifica la direttiva 2009/104/EC) concerns the minimum safety and health requirements for the use of work equipment by workers at work.

## Respecting legal requirements



### Switzerland

- UVG – Federal Law on Accident Insurance  
VUV – Regulation on the Prevention of Accidents and Occupational Diseases  
title 1, chapter 2, paragraph 1, art. 3; title 1, chapter 3, paragraph 2, art. 30, 31  
paragraph 3, art. 37; paragraph 4, art. 43
- EKAS Guideline no. 6512 – Work Equipment

*These regulations clearly stipulate that during maintenance, adjusting or cleaning of the equipment, it has to be in non-operative state and appropriate devices have to be used to ensure that, for example, a machine is not accidentally switched on.*



### Spain

The Spanish directive (REAL DECRETO 1215/1997, de 18 de julio por el que se establecen las disposiciones mínimas de seguridad y salud para la utilización por los trabajadores de los equipos de trabajo. BOE nº 188 07-08-1997) states the minimum safety and health for workers' use of work equipment.



### UK only: BS7671:2008

In the UK the Provision of Work Equipment Regulations – Regulation 19 – Isolation from Sources of Energy states: “Every employer shall ensure, that where appropriate, work equipment is provided with suitable means to isolate it from all its sources of energy. Every employer shall take appropriate measures to ensure that reconnection of any energy source to work equipment does not expose any person using the equipment to any risk to his health or safety.



### USA (OSHA - Occupational Safety & Health Administration)

OSHA regulation The Control of Hazardous Energy (Lockout / Tagout) 1910.147 states that it “requires employers to establish a programme and utilise procedures for affixing appropriate lockout devices or tagout devices to energy isolating devices and to otherwise disable machines or equipment to prevent unexpected energisation, start up or release of stored energy in order to prevent injury to employees.



**Implemented LOCKOUT/TAGOUT is the law in some EU countries and considered to be best practice in all European countries!**

## ATEX certification

The ATEX directive consists of two EU directives describing what equipment and work environment is necessary to maintain safety in spaces with a potentially explosive atmosphere.

This ATEX directive was published on Saturday 29 March 2014, under the reference : Directive 2014/34/EU of the European Parliament and of the Council of 26 February 2014 on the harmonisation of the laws of the Member States relating to equipment and protective systems intended for use in potentially explosive atmospheres (recast) (Text with EEA relevance) - Official Journal of the European Union L 96 from 29/03/2014.

Areas classified into zones (0, 1, 2 for gas-vapor-mist and 20, 21, 22 for dust) must be protected from effective sources of ignition.[1] Equipment and protective systems intended to be used in zoned areas must meet the requirements of the directive. Zone 0 and 20 require Category 1 marked equipment, zone 1 and 21 require Category 2 marked equipment and zone 2 and 22 require Category 3 marked equipment. Zone 0 and 20 are the zones with the highest risk of an explosive atmosphere being present.

Equipment in use before July 2003 is allowed to be used indefinitely provided a risk assessment shows it is safe to do so. The aim of directive 94/9/EC is to allow the free trade of ‘ATEX’ equipment and protective systems within the EU by removing the need for separate testing and documentation for each member state.

The regulations apply to all equipment intended for use in explosive atmospheres, whether electrical or mechanical, including protective systems. There are two categories of equipment ‘I’ for mining and ‘II’ for surface industries.

The directive covers a large range of equipment, potentially including equipment used on fixed offshore platforms, in petrochemical plants, mines, flour mills and other areas where a potentially explosive atmosphere may be present. Several of Brady's lockout devices and padlocks are ATEX certified. These are highlighted in the brochure.

## Visualise and manage your safety procedures

One of the biggest challenges in maintaining a safe facility is information management. There are Lockout/Tagout procedures, confined space permits, maintenance schedules and other important documents. They all need to be regularly updated and reviewed. For safety and productivity in manufacturing and services workplaces, Brady Safety Services is a resource like no other. We work together with you to develop custom, comprehensive solutions to elevate your visual workplace – for today and for the years ahead.



## Visual procedures assistance

Our degreed engagement specialists work with you to determine the scope of the work. They complete an in-depth survey and provide product & procedure recommendations with facility photos to align with regulatory and visual workplace requirements

## Procedure writing services

Writing procedures can be time consuming and cumbersome, especially with limited internal resources. This is when Brady's expert team of field engineers can help. Our procedure writing services go beyond helping comply with regulatory requirements.

- Professional evaluation of your needs and equipment requirements
- Creation of visually instructive procedures specific to your machinery, facility and employee safety requirements.
- Collaboration with your team during the process, helping you understand how to successfully maintain the programme in-house.

New procedures can be inserted into the LINK360™ software to be evaluated and validated by safety professionals in your company before they become official.



## Discover the LINK360™ software solution advantage

Link360™ Software is the first software to give you a complete view of the activities associated with creating, reviewing and updating visual information. This software provides an easy way to keep your safety procedures accurate, compliant and sustainable – both in your facility and across multiple locations.

## Discover the LINK360™ software modules

Pre-defined templates and the ability to easily add users from any site in your company, create a comprehensive yet easy to use solution to manage your Lockout/Tagout, Reliability and Confined Space activities.

**BRADY LINK360**

Home - Brady LINK360

Home | Field/Check Files | Setup & Admin | Lockout/Tagout | Confined Spaces | Reliability

Home | Reports | Open Permits | Pending Your Review | Open Comments | Audits Due | Out for Review | Reports Published | New Alerts

View Chart

Create and route reporting charts

Route procedures and permits for review

Task notifications and alerts

Pre-defined templates for quick creation

The lockout/tagout Module focuses on creating and maintaining a safe working environment with tools to help lock out hazardous energy sources. By accessing this module users can:

- Manage lockout/tagout programmes to perform maintenance on machinery.
- Create visually instructive safety procedures, tags, and energy source labels for printing.
- Meet regulatory requirements and industry standards on lockout of hazardous energy sources.
- Free mobile app for iOS or Android, mobile phones and tablets.



Watch the LINK360 introduction on Brady's YouTube™ channel



The Reliability Module provides tools to streamline regular equipment checks.

By accessing this module users can:

- Manage the creation of visually instructive maintenance procedures that assist operators, engineers, and technicians in maintaining machine equipment performance levels.
- Control access to who may view, edit, and create templates and procedures.
- Free mobile app for iOS or Android, mobile phones and tablets.



The Confined Spaces Module allows users to compile assessments, create permits, and track history for confined space permitting.

- Identify confined space hazards and classify a space as a 'permit required' confined space.
- Entrants are able to fill out permission requests online for approval.
- Meet regulatory requirements and industry standards on lockout of hazardous energy sources.
- Permission history is logged for future audits and reporting.



### Download now!

Download the iOS app or Android



iOS



Android

LINK360 cloud-based answers the most pressing visual information needs. Faced with the task of handling visual information across multiple locations, companies need a way to take the management of equipment visuals to the next level by closing the loop on scalability and sustainability.

## Discover the LINK360 benefits

### Achieve compliance and productivity goals

- Quickly and easily correct inaccuracies, while maintaining a safe working environment for employees and an optimal level of equipment protection.
- Eliminate confusing visuals, comprehension, and language translation issues by creating clear, concise, and easy-to-follow signage in minutes.

### Maintain consistency and scalability

- Grant permissions and rights for viewing, editing and creating templates and procedures for standardised use across all locations.
- Stop the use of varying formats, symbols and languages for equipment visuals across the organisation for clear communication.

### Sustain and improve performance levels

- As changes occur with the equipment, keep visuals up-to-date through the use of audit alerts, notifications, and reports.
- Monitor, measure, and improve effectiveness of procedures with ease.

### Secure access to your company's data

- Secured Socket Layer (SSL) encryption is in place for data transmission.
- Set user defined permissions that restrict or allow access to sites, areas, and equipment.



Visit [www.bradyeurope.com/LOTOservices](http://www.bradyeurope.com/LOTOservices) today to watch the video or to request a demo



## Effective control of hazardous energy

To ensure de-energisation and isolation of all potentially hazardous energies that supply production or facility operating equipment, so that the equipment can be safely serviced or maintained.

**Energy isolating device** – a mechanical device that, when utilised or activated, physically prevents the transmission or release of energy, including

- a manually operated electrical circuit breaker
- a disconnect switch
- a gate / ball / plug / butterfly shut-off valve



## Hazardous energies where LO/TO is the ideal means of control:

- Electrical
- Mechanical
- Pneumatic
- Hydraulic
- Liquid & gaseous chemicals
- Thermal
- Hot surfaces & substances
- Gravitational
- Overhead objects or equipment that may fall & crush
- Other stored energy
- Flywheel stopped mid-motion, residual electrical that needs to be bled

Remember that production, plant or facility equipment commonly have **more than 2 types of energy present.**



## Padlocks

Brady's high quality padlocks are ideally suited for lockout tagout applications.

- 16 Find the best padlock for your needs
- 18 Brady SafeKey Lockout Padlocks
- 20 Padlock comparison
- 22 SafeKey Nylon Padlocks
- 24 Traditional Nylon Padlocks
- 25 SafeKey Nylon Compact Padlocks
- 26 Traditional Nylon Compact Padlocks
- 27 Traditional Nylon Compact Cable Padlocks
- 28 Safety Security Padlocks
- 28 Brass Padlocks
- 29 SafeKey Aluminium Padlocks
- 30 Traditional Full Aluminium Padlocks
- 31 Traditional Aluminium Compact Padlocks
- 32 Laminated Steel Padlocks
- 32 Ultimate Security Padlocks
- 33 Fully Insulated Padlocks
- 33 Brass Padlocks with stainless steel shackle
- 33 Brass Padlocks with hardened steel shackle
- 33 Combination padlock
- 34 Labels and tags for padlocks
- 35 Padlock lubricant
- 35 Cable & chain





# Find the best padlock for your needs

With so many options available, choosing the right padlock for your job can be confusing. Let us help you get the padlock that fits your needs.

## Body material options



### Nylon

#### Non-conductive

Ideal for electrical applications and enclosures

#### Easy to carry

Lightweight with ribbed design for easy gripping

#### Key retaining security\*

Key releases only on lock closure

#### Most common

Preferred for most indoor lockout applications



### Aluminium

#### Long-lasting

Anodised, corrosion-resistant finish provides extended life

#### Increased security

Durable construction for better tamper resistance

#### Corrosion resistant

Resilient against harsh environments, such as food, oil and chemical

#### Versatile usage

Great for indoor and outdoor use



### Steel

#### Heavy-duty

Laminated steel body withstands severe physical abuse

#### Maximum corrosion protection

Individual coated steel plates protects against extreme corrosion

#### Key retaining security

Key releases only on lock closure

#### Highest durability

High performance in extreme outdoor and harsh environments

\*Not all nylon padlocks have a key retaining feature

## Body size options



### Compact

#### Material availability

Nylon, aluminium

#### Ideal usage

Everyday applications, small spaces and circuit breakers

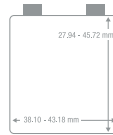

### Standard

#### Material availability

Nylon, aluminium, steel

#### Ideal usage

Fits wide variety of devices - electrical, valve and cable



### Long body

#### Material availability

Nylon only

#### Ideal usage

Displaying additional information and languages on body label

## Shackle material options



### Steel shackle

#### Vertical Clearance Options

20, 38, 50, 76 mm

#### Body Material Availability

Nylon, aluminium, steel

#### Ideal Usage

Most common with extra durability for tough environments



### Plastic shackle

#### Vertical Clearance Options

25, 38 mm

#### Body Material Availability

Nylon only

#### Ideal Usage

Non-conductive for working on electrical circuits/panels



### Cable shackle

#### Vertical Clearance Options

106.68 & 203.20 mm

#### Body Material Availability

Nylon only

#### Ideal Usage

Versatile, multi-purpose solution, angle and twist to fit tight spaces

## Body colour options

### Body material

### Available colours

Nylon











Aluminium



Steel



## Shackle size options

|                         |  |  |  |  |  |  |  |  |
|-------------------------|---|---|---|---|---|--|---|---|
| <b>Shackle size</b>     | 20 mm   | 25 mm   | 38 mm   | 40 mm   | 50 mm   | 75 mm  | 106.68 mm   | 203.20 mm   |
| <b>Shackle material</b> | Steel only  | Nylon, aluminium, steel   | Nylon, aluminium, steel   | Aluminium   | Aluminium, steel  | Steel only   | Cable only  | Cable only  |
| <b>Body size</b>        | Standard only   | Compact only  | Standard, Compact, Long   | Standard, Compact   | Standard, Compact   | Standard, Compact  | Compact only  | Compact only  |
| <b>Body material</b>    | Steel only  | Nylon, aluminium  | Nylon, aluminium  | Aluminium only  | Steel only  | Nylon, aluminium, steel  | Nylon only  | Nylon only  |

## Padlock types



### SafeKey Lockout Padlocks

#### Advanced Key Security

Patent-pending locking mechanism includes six precision steel tumbler blades

#### More Unique Key Possibilities

Ideal for large organisations using hundreds to thousands of locks

#### Easy Operation

Extra smooth key insertion and removal – even when wearing gloves!

#### Long-lasting

Linear, low-friction lock mechanism helps maintain key integrity



### Traditional Padlocks

#### Classic Padlock Design

Traditional jagged key design and pin tumbler lock mechanism

#### Fewer Key Combinations

Ideal for small work groups and facilities with fewer energy isolation points

#### Multi-purpose Solution

Flexible cable locks available for tight spaces and simultaneous lockout points

#### More Material Options

Available in non-conductive nylon, aluminum and laminated steel lock bodies

## Keying options

### Standard options



**Keyed Different (KD)** – Each lock is opened by its own unique key. Perfect for simple lockout applications and a manageable number of energy isolation points.



**Keyed Alike (KA)** – Each lock in the group can be opened with the same key. Easy to find the right key, reduces number of keys needed to carry. Ideal for individuals or trades responsible for multiple machines or isolation points.

### Custom options



**Master Keyed (MK)** – Each grouping of locks (whether keyed alike or different) can be opened with a master key. Useful for larger, complex systems when supervisory access may be required

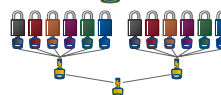

**Grand Master Keyed (GMK)** – The grand master key can open all locks grouped into two or more master keyed systems. Useful for larger, complex systems where supervisory or managerial access to all locks in the facility is needed.

## Laser engraving - Customise your padlocks



If the locks in your safety system are assigned to a single worker, you might want to imprint that person's name onto the lock. This way, the locks will not get mixed up between workers and a clear distinction can be made. You can also write the function of certain locks onto the body or number them if necessary.

We offer to do every kind of engraving on the locks for you so that you receive them just the way you want them to be. If you need more information, just ask us about the different possibilities.

## Made like no other

In the last 50 years we've seen a manufacturing technology boom matched only by the industrial revolution. In fact, industrial maintenance employment has grown by more than 20% in the last decade.\* With these advances, lockout needs have grown. Choose SafeKey Lockout Padlocks, exclusively from Brady, to lock in to ultimate key precision and advanced key security for years to come.

With this innovatively designed padlock you get up to **700% more unique key possibilities than a standard safety padlock**, without sacrificing a secure lockout. It's all in the forward-thinking design of the locking mechanism and unique key blade that gives you more precision and control in your lockout programme. With that level of precision, you're covered from your simple to highly complex lockout needs. You also get:

- easy operation with extra smooth key insertion and removal – even when wearing gloves!
- fast identification with the colour-matched key and lock body
- years of use with the low-friction locking mechanism that helps maintain key integrity
- excellent durability in every industrial environment



9 different colour options available

\*U.S. Bureau of Labor Statistics.  
(2019, January 22). Occupational Employment Statistics. <https://www.bls.gov/oes/tables.htm>

## See the difference in the details

Product innovations are only as good as the benefits they provide. See the difference you get with the patent-pending SafeKey Lockout Padlocks:

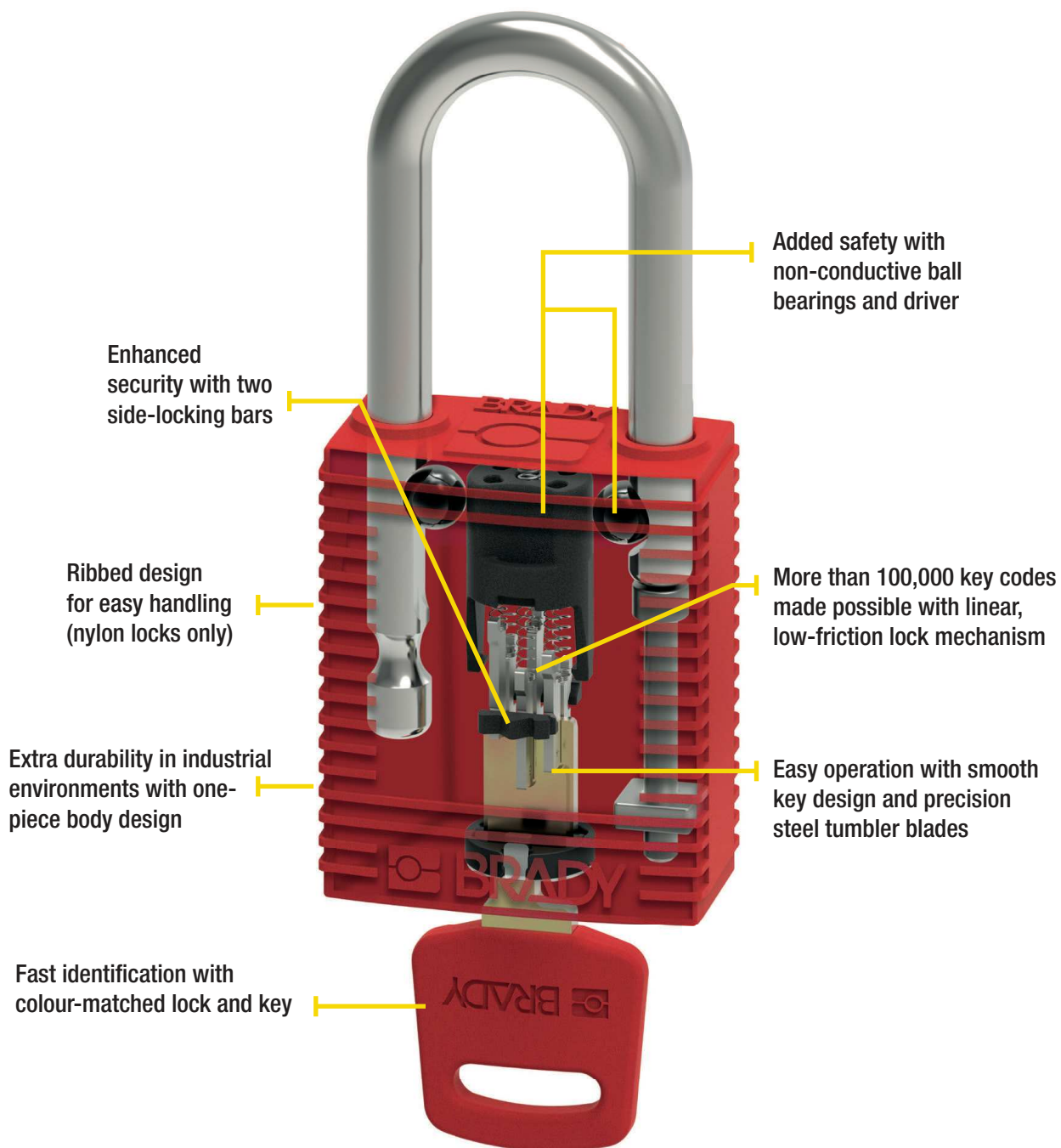

### Traditional safety padlocks

- Pin tumbler lock mechanism
- Jagged key design
- Up to 15,000 key codes



See the new SafeKey Lockout Padlocks in action

Watch the video on:

[www.bradyeurope.com/SafeKey](http://www.bradyeurope.com/SafeKey)



# Padlock comparison



|                                   | Traditional Nylon Compact - aluminium shackle | SafeKey Nylon Compact - plastic shackle | Traditional Nylon Compact - Cable | Traditional Nylon - steel shackle | SafeKey Nylon - steel shackle | Traditional Full Nylon | SafeKey Nylon - plastic shackle |
|-----------------------------------|---|---|-----------------------------------|-----------------------------------|-------------------------------|------------------------|---------------------------------|
| <b>Key mechanism</b>              | Pin Tumbler                                   | Linear Blade                            | Pin Tumbler                       | Pin Tumbler                       | Linear Blade                  | Pin Tumbler            | Linear Blade                    |
| <b>Shackle</b>                    |   |   |                                   |                                   |                               |                        |                                 |
| Stainless steel                   |   |   |                                   |                                   | 38/76                         |                        |                                 |
| Hardened steel                    |   |   |                                   | 38 (75*)                          |                               |                        |                                 |
| Nylon (polymer plastic)           |   | 25                                      |                                   |                                   |                               | 38                     | 38                              |
| Aluminium                         | 25/38/50/75                                   |   |                                   | 38*/75*                           |                               |                        |                                 |
| Brass                             |   |   |                                   |                                   |                               |                        |                                 |
| Nylon encased steel               |   |   |                                   |                                   |                               |                        |                                 |
| PVC encased steel cable           |   |   | 200/400                           |                                   |                               |                        |                                 |
| Diameter                          | 4.70  | 4.30                                    | 4.70                              | 6.50                              | 6.40                          | 6.50                   | 6.40                            |
| <b>Colours</b>                    |   |   |                                   |                                   |                               |                        |                                 |
| Red                               | •   | •                                       | •                                 | •                                 | •                             | •                      | •                               |
| Yellow                            | •   | •                                       | •                                 | •                                 | •                             | •                      | •                               |
| Black                             | •   | •                                       | •                                 | •                                 | •                             | •                      | •                               |
| Blue                              | •   | •                                       | •                                 | •                                 | •                             | •                      | •                               |
| Green                             | •   | •                                       | •                                 | •                                 | •                             | •                      | •                               |
| Orange                            | •   | •                                       | •                                 | •                                 | •                             | •                      | •                               |
| Grey (silver)                     | •   | •                                       | •                                 | •                                 | •                             | •                      | •                               |
| White                             | •   | •                                       | •                                 | •                                 | •                             | •                      | •                               |
| Brown                             | •   | •                                       | •                                 | •                                 | •                             | •                      | •                               |
| Purple                            | •   | •                                       | •                                 | •                                 | •                             | •                      | •                               |
| <b>Key possibilities</b>          |   |   |                                   |                                   |                               |                        |                                 |
| KD                                | •   | •                                       | •                                 | •                                 | •                             | •                      | •                               |
| KA                                | •   | •                                       | •                                 | •                                 | •                             | •                      | •                               |
| MK                                | •   | •                                       | •                                 | •                                 | •                             | •                      | •                               |
| GMK                               | •   | •                                       | •                                 | •                                 | •                             | •                      | •                               |
| Key chart                         | •   | •                                       | •                                 | •                                 | •                             | •                      | •                               |
| # keys for KD                     | 1   | 1                                       | 1                                 | 1                                 | 1                             | 1                      | 1                               |
| # keys for KA/MK/GMK              | 2   | 1                                       | 2                                 | 2                                 | 1                             | 2                      | 1                               |
| Key-retaining                     | •   | •                                       | •                                 | •                                 | •                             | •                      | •                               |
| # of pins/blades                  | 5   | 6                                       | 5                                 | 6                                 | 6                             | 6                      |                                 |
| <b>Engraving</b>                  |   |   |                                   |                                   |                               |                        |                                 |
| Front                             | •   | •                                       | •                                 | •                                 | •                             | •                      | •                               |
| Back                              | •   | •                                       | •                                 | •                                 | •                             | •                      | •                               |
| Side                              | •   | •                                       | •                                 | •                                 | •                             | •                      | •                               |
| Bottom                            |   |   |                                   |                                   |                               |                        |                                 |
| Key                               | •   | •                                       | •                                 | •                                 | •                             | •                      | •                               |
| Labels supplied                   | EN/FR   | EN/FR/ES                                | EN/FR                             | EN/FR                             | EN/FR/ES                      | EN/FR                  | EN/FR/ES                        |
| <b>Can be combined with</b>       |   |   |                                   |                                   |                               |                        |                                 |
| Traditional Nylon Compact         | •   |   | •                                 | •                                 |                               | •                      |                                 |
| SafeKey Nylon Compact             |   | •                                       |                                   |                                   | •                             |                        | •                               |
| Traditional Nylon Compact - Cable | •   |   | •                                 | •                                 |                               | •                      |                                 |
| Traditional Nylon                 | •   |   | •                                 | •                                 |                               | •                      |                                 |
| SafeKey Nylon                     |   | •                                       |                                   |                                   | •                             |                        | •                               |
| Traditional Full Nylon            | •   |   | •                                 | •                                 |                               | •                      |                                 |
| SafeKey Nylon                     |   | •                                       |                                   |                                   | •                             |                        | •                               |
| Traditional Nylon - Long Body     | •   |   | •                                 | •                                 |                               | •                      |                                 |
| Traditional Aluminium Compact     | •   |   | •                                 | •                                 |                               | •                      |                                 |
| Traditional Full Aluminium        | •   |   | •                                 | •                                 |                               | •                      |                                 |
| SafeKey Aluminium                 |   | •                                       |                                   |                                   | •                             |                        | •                               |

\*Only on request \*\*Non key retaining on request



| Traditional Long Body | Traditional Aluminium Compact - aluminium shackle | Traditional Full Aluminium | SafeKey Aluminium - steel shackle | Safety Security | Steel          | Brass       |
|-----------------------|---|----------------------------|-----------------------------------|-----------------|----------------|-------------|
| Pin Tumbler           | Pin Tumbler                                       | Pin Tumbler                | Linear Blade                      | Pin Tumbler     | Pin Tumbler    | Pin Tumbler |
|                       |   |                            |                                   |                 | 20/38/51 (75*) |             |
| 38*                   |   |                            |                                   |                 |                |             |
| 38*                   | 25/40/50/75                                       | 25/40/75                   | 38/76                             |                 |                | 21          |
|                       |   |                            |                                   | 38/75           |                |             |
| 6.50                  | 4.70  | 6.50                       | 6.40                              | 6.50            | 7.00           | 6.50        |
| •                     | •   | •                          | •                                 | •               | •              | •           |
| •                     | •   | •                          | •                                 | •               | •              | •           |
| •                     | •   | •                          | •                                 | •               | •              | •           |
| •                     | •   | •                          | •                                 | •               | •              | •           |
| •                     | •   | •                          | •                                 | •               | •              | •           |
| •*                    | •*  | •                          | •                                 | •*              | •              | •           |
| •*                    | •*  | •                          | •                                 | •               | •              | •           |
| •*                    | •*  | •                          | •                                 | •*              | •              | •           |
| •                     | •   | •                          | •                                 | •               | •              | •           |
| •                     | •   | •                          | •                                 | •               | •              | •           |
| •                     | •   | •                          | •                                 | •               | •              | •           |
| •                     | •   | •                          | •                                 | •               | •              | •           |
| •                     | •   | •                          | •                                 | •               | •              | •           |
| 1                     | 1   | 2                          | 1                                 | 1               | 1              | 2           |
| 2                     | 2   | 2                          | 1                                 | 1               | 2              | 2           |
| •                     | •   | •*                         | •                                 | •**             | •              | •*          |
| 6                     | 5   | 6                          | 6                                 | 6               | 5              | 4           |
| •                     | •   | •                          | •                                 | •               | •              | •           |
| •                     | •   | •                          | •                                 | •               | •              | •           |
| •                     | •   | •                          | •                                 | •               | •              | •           |
| •                     | •   | •                          | •                                 | •               | •              | •           |
| •                     | •   | •                          | •                                 | •               | •              | •           |
| EN/FR, EN/ES          |   |                            |                                   | EN/FR, EN/ES    |                |             |
| •                     | •   | •                          | •                                 | •               | •              | •           |
| •                     | •   | •                          | •                                 | •               | •              | •           |
| •                     | •   | •                          | •                                 | •               | •              | •           |
| •                     | •   | •                          | •                                 | •               | •              | •           |
| •                     | •   | •                          | •                                 | •               | •              | •           |
| •                     | •   | •                          | •                                 | •               | •              | •           |
| •                     | •   | •                          | •                                 | •               | •              | •           |
| •                     | •   | •                          | •                                 | •               | •              | •           |



## SafeKey Nylon Padlocks with steel shackle

- Lightweight non-sparking nylon body with a durable steel shackle
- Non-conductive locking mechanism
- Ribbed design for safe handling
- Ideal for general lockout applications
- Key-retaining lock feature

1 key supplied for each padlock. Custom keying options available. Supplied with padlock labels in English, French and Spanish. Engraving on front, back, left side, right side and key.

**i** Consult the technical datasheet LOTO-101 on [bradyeurope.com/tds](http://bradyeurope.com/tds)



| Order Reference  | Colour   | Shackle Height (mm) | Shackle Diameter (mm) | Shackle Clearance (mm) | Shackle Width (mm) | Depth (mm) | Height (mm) | Width (mm) | Quantity |
|--|----------|---------------------|-----------------------|------------------------|--------------------|------------|-------------|------------|----------|
| <b>Shackle Height 38 mm / KA - Keyed Alike / pack of 3</b>       |          |                     |                       |                        |                    |            |             |            |          |
| 150294   | ● Black  | 38.00               | 6.40                  | 20.00                  | 33.00              | 19.00      | 84.00       | 38.00      | 3        |
| 150317   | ● Blue   | 38.00               | 6.40                  | 20.00                  | 33.00              | 19.00      | 84.00       | 38.00      | 3        |
| 150228   | ● Brown  | 38.00               | 6.40                  | 20.00                  | 33.00              | 19.00      | 84.00       | 38.00      | 3        |
| 150341   | ● Green  | 38.00               | 6.40                  | 20.00                  | 33.00              | 19.00      | 84.00       | 38.00      | 3        |
| 150364   | ● Orange | 38.00               | 6.40                  | 20.00                  | 33.00              | 19.00      | 84.00       | 38.00      | 3        |
| 150229   | ● Purple | 38.00               | 6.40                  | 20.00                  | 33.00              | 19.00      | 84.00       | 38.00      | 3        |
| 150271   | ● Red    | 38.00               | 6.40                  | 20.00                  | 33.00              | 19.00      | 84.00       | 38.00      | 3        |
| 150340   | ○ White  | 38.00               | 6.40                  | 20.00                  | 33.00              | 19.00      | 84.00       | 38.00      | 3        |
| 150246   | ● Yellow | 38.00               | 6.40                  | 20.00                  | 33.00              | 19.00      | 84.00       | 38.00      | 3        |
| <b>Shackle Height 38 mm / KD - Keyed Differently / pack of 1</b> |          |                     |                       |                        |                    |            |             |            |          |
| 150234   | ● Black  | 38.00               | 6.40                  | 20.00                  | 33.00              | 19.00      | 84.00       | 38.00      | 1        |
| 150251   | ● Blue   | 38.00               | 6.40                  | 20.00                  | 33.00              | 19.00      | 84.00       | 38.00      | 1        |
| 150275   | ● Brown  | 38.00               | 6.40                  | 20.00                  | 33.00              | 19.00      | 84.00       | 38.00      | 1        |
| 150368   | ● Green  | 38.00               | 6.40                  | 20.00                  | 33.00              | 19.00      | 84.00       | 38.00      | 1        |
| 150320   | ● Orange | 38.00               | 6.40                  | 20.00                  | 33.00              | 19.00      | 84.00       | 38.00      | 1        |
| 150250   | ● Purple | 38.00               | 6.40                  | 20.00                  | 33.00              | 19.00      | 84.00       | 38.00      | 1        |
| 150321   | ● Red    | 38.00               | 6.40                  | 20.00                  | 33.00              | 19.00      | 84.00       | 38.00      | 1        |
| 150367   | ○ White  | 38.00               | 6.40                  | 20.00                  | 33.00              | 19.00      | 84.00       | 38.00      | 1        |
| 150343   | ● Yellow | 38.00               | 6.40                  | 20.00                  | 33.00              | 19.00      | 84.00       | 38.00      | 1        |
| <b>Shackle Height 38 mm / KD - Keyed Differently / pack of 6</b> |          |                     |                       |                        |                    |            |             |            |          |
| 150224   | ● Black  | 38.00               | 6.40                  | 20.00                  | 33.00              | 19.00      | 84.00       | 38.00      | 6        |
| 150316   | ● Blue   | 38.00               | 6.40                  | 20.00                  | 33.00              | 19.00      | 84.00       | 38.00      | 6        |
| 150269   | ● Brown  | 38.00               | 6.40                  | 20.00                  | 33.00              | 19.00      | 84.00       | 38.00      | 6        |
| 150337   | ● Green  | 38.00               | 6.40                  | 20.00                  | 33.00              | 19.00      | 84.00       | 38.00      | 6        |
| 150336   | ● Orange | 38.00               | 6.40                  | 20.00                  | 33.00              | 19.00      | 84.00       | 38.00      | 6        |
| 150362   | ● Purple | 38.00               | 6.40                  | 20.00                  | 33.00              | 19.00      | 84.00       | 38.00      | 6        |
| 150270   | ● Red    | 38.00               | 6.40                  | 20.00                  | 33.00              | 19.00      | 84.00       | 38.00      | 6        |
| 150292   | ○ White  | 38.00               | 6.40                  | 20.00                  | 33.00              | 19.00      | 84.00       | 38.00      | 6        |
| 150225   | ● Yellow | 38.00               | 6.40                  | 20.00                  | 33.00              | 19.00      | 84.00       | 38.00      | 6        |
| <b>Shackle Height 76 mm / KD - Keyed Differently / pack of 1</b> |          |                     |                       |                        |                    |            |             |            |          |
| 150274   | ● Black  | 76.00               | 6.40                  | 20.00                  | 33.00              | 19.00      | 122.00      | 38.00      | 1        |
| 150249   | ● Blue   | 76.00               | 6.40                  | 20.00                  | 33.00              | 19.00      | 122.00      | 38.00      | 1        |
| 150247   | ● Brown  | 76.00               | 6.40                  | 20.00                  | 33.00              | 19.00      | 122.00      | 38.00      | 1        |
| 150319   | ● Green  | 76.00               | 6.40                  | 20.00                  | 33.00              | 19.00      | 122.00      | 38.00      | 1        |
| 150248   | ● Orange | 76.00               | 6.40                  | 20.00                  | 33.00              | 19.00      | 122.00      | 38.00      | 1        |
| 150233   | ● Purple | 76.00               | 6.40                  | 20.00                  | 33.00              | 19.00      | 122.00      | 38.00      | 1        |
| 150357   | ● Red    | 76.00               | 6.40                  | 20.00                  | 33.00              | 19.00      | 122.00      | 38.00      | 1        |
| 150295   | ○ White  | 76.00               | 6.40                  | 20.00                  | 33.00              | 19.00      | 122.00      | 38.00      | 1        |
| 150296   | ● Yellow | 76.00               | 6.40                  | 20.00                  | 33.00              | 19.00      | 122.00      | 38.00      | 1        |



## SafeKey Nylon Padlocks with plastic shackle

- Lightweight non-sparking nylon body with polymer plastic shackle that's non-conductive and non-sparking
- Non-conductive locking mechanism
- Ribbed design for safe handling
- Ideal for electrical applications or general lockout applications
- Key-retaining lock feature

1 key supplied for each padlock. Custom keying options available.  
 Supplied with padlock labels in English, French and Spanish.  
 Engraving on front, back, left side, right side and key.

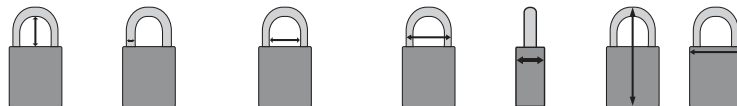

| Order Reference  | Colour   | Shackle Height (mm) | Shackle Diameter (mm) | Shackle Clearance (mm) | Shackle Width (mm) | Depth (mm) | Height (mm) | Width (mm) | Quantity |
|--|----------|---------------------|-----------------------|------------------------|--------------------|------------|-------------|------------|----------|
| <b>Shackle Height 38 mm / KA - Keyed Alike / pack of 3</b>       |          |                     |                       |                        |                    |            |             |            |          |
| 150315   | ● Black  | 38.00               | 6.40                  | 20.00                  | 33.00              | 19.00      | 84.00       | 38.00      | 3        |
| 150268   | ● Blue   | 38.00               | 6.40                  | 20.00                  | 33.00              | 19.00      | 84.00       | 38.00      | 3        |
| 150314   | ● Brown  | 38.00               | 6.40                  | 20.00                  | 33.00              | 19.00      | 84.00       | 38.00      | 3        |
| 150223   | ● Green  | 38.00               | 6.40                  | 20.00                  | 33.00              | 19.00      | 84.00       | 38.00      | 3        |
| 150222   | ● Orange | 38.00               | 6.40                  | 20.00                  | 33.00              | 19.00      | 84.00       | 38.00      | 3        |
| 150353   | ● Purple | 38.00               | 6.40                  | 20.00                  | 33.00              | 19.00      | 84.00       | 38.00      | 3        |
| 150291   | ● Red    | 38.00               | 6.40                  | 20.00                  | 33.00              | 19.00      | 84.00       | 38.00      | 3        |
| 150267   | ○ White  | 38.00               | 6.40                  | 20.00                  | 33.00              | 19.00      | 84.00       | 38.00      | 3        |
| 150290   | ● Yellow | 38.00               | 6.40                  | 20.00                  | 33.00              | 19.00      | 84.00       | 38.00      | 3        |
| <b>Shackle Height 38 mm / KD - Keyed Differently / pack of 1</b> |          |                     |                       |                        |                    |            |             |            |          |
| 150231   | ● Black  | 38.00               | 6.40                  | 20.00                  | 33.00              | 19.00      | 84.00       | 38.00      | 1        |
| 150366   | ● Blue   | 38.00               | 6.40                  | 20.00                  | 33.00              | 19.00      | 84.00       | 38.00      | 1        |
| 150318   | ● Brown  | 38.00               | 6.40                  | 20.00                  | 33.00              | 19.00      | 84.00       | 38.00      | 1        |
| 150273   | ● Green  | 38.00               | 6.40                  | 20.00                  | 33.00              | 19.00      | 84.00       | 38.00      | 1        |
| 150230   | ● Orange | 38.00               | 6.40                  | 20.00                  | 33.00              | 19.00      | 84.00       | 38.00      | 1        |
| 150272   | ● Purple | 38.00               | 6.40                  | 20.00                  | 33.00              | 19.00      | 84.00       | 38.00      | 1        |
| 150342   | ● Red    | 38.00               | 6.40                  | 20.00                  | 33.00              | 19.00      | 84.00       | 38.00      | 1        |
| 150365   | ○ White  | 38.00               | 6.40                  | 20.00                  | 33.00              | 19.00      | 84.00       | 38.00      | 1        |
| 150232   | ● Yellow | 38.00               | 6.40                  | 20.00                  | 33.00              | 19.00      | 84.00       | 38.00      | 1        |
| <b>Shackle Height 38 mm / KD - Keyed Differently / pack of 6</b> |          |                     |                       |                        |                    |            |             |            |          |
| 150351   | ● Black  | 38.00               | 6.40                  | 20.00                  | 33.00              | 19.00      | 84.00       | 38.00      | 6        |
| 150221   | ● Blue   | 38.00               | 6.40                  | 20.00                  | 33.00              | 19.00      | 84.00       | 38.00      | 6        |
| 150309   | ● Brown  | 38.00               | 6.40                  | 20.00                  | 33.00              | 19.00      | 84.00       | 38.00      | 6        |
| 150334   | ● Green  | 38.00               | 6.40                  | 20.00                  | 33.00              | 19.00      | 84.00       | 38.00      | 6        |
| 150310   | ● Orange | 38.00               | 6.40                  | 20.00                  | 33.00              | 19.00      | 84.00       | 38.00      | 6        |
| 150350   | ● Purple | 38.00               | 6.40                  | 20.00                  | 33.00              | 19.00      | 84.00       | 38.00      | 6        |
| 150311   | ● Red    | 38.00               | 6.40                  | 20.00                  | 33.00              | 19.00      | 84.00       | 38.00      | 6        |
| 150308   | ○ White  | 38.00               | 6.40                  | 20.00                  | 33.00              | 19.00      | 84.00       | 38.00      | 6        |
| 150265   | ● Yellow | 38.00               | 6.40                  | 20.00                  | 33.00              | 19.00      | 84.00       | 38.00      | 6        |







## Traditional Nylon Padlocks

With a variety of different shackle sizes, materials and colours!

- Comes standard with hardened steel shackle for enhanced security or with nylon shackle to cut off the electrical current from the shackle to the key
- Aluminium shackle available on request for a significant reduction in weight
- Available in 10 different colours
- Key retaining system (Key won't release until padlock shackle is correctly closed)
- Optional laser engraving\*

Locks are supplied keyed different. 1 key supplied with each padlock.

Custom keying options available.

Supplied with padlock labels in English/French for Standard & Nylon and English/French and English/Spanish for Long Body.

## Traditional Nylon Padlocks with hardened steel shackle



Consult the technical datasheet LOTO-8 on [bradyeurope.com/tds](http://bradyeurope.com/tds)



| Order Reference | Colour   | Shackle Height (mm) | Shackle Diameter (mm) | Shackle Clearance (mm) | Shackle Width (mm) | Depth (mm) | Height (mm) | Width (mm) | Quantity |
|-----------------|----------|---------------------|-----------------------|------------------------|--------------------|------------|-------------|------------|----------|
| 051353          | ● Black  | 38.00               | 6.50                  | 20.00                  | 33.00              | 19.50      | 86.50       | 38.50      | 6        |
| 051344          | ● Blue   | 38.00               | 6.50                  | 20.00                  | 33.00              | 19.50      | 86.50       | 38.50      | 6        |
| 813636          | ● Brown  | 38.00               | 6.50                  | 20.00                  | 33.00              | 19.50      | 86.50       | 38.50      | 6        |
| 051345          | ● Green  | 38.00               | 6.50                  | 20.00                  | 33.00              | 19.50      | 86.50       | 38.50      | 6        |
| 814113          | ● Grey   | 38.00               | 6.50                  | 20.00                  | 33.00              | 19.50      | 86.50       | 38.50      | 6        |
| 051347          | ● Orange | 38.00               | 6.50                  | 20.00                  | 33.00              | 19.50      | 86.50       | 38.50      | 6        |
| 813637          | ● Purple | 38.00               | 6.50                  | 20.00                  | 33.00              | 19.50      | 86.50       | 38.50      | 6        |
| 051339          | ● Red    | 38.00               | 6.50                  | 20.00                  | 33.00              | 19.50      | 86.50       | 38.50      | 6        |
| 813638          | ○ White  | 38.00               | 6.50                  | 20.00                  | 33.00              | 19.50      | 86.50       | 38.50      | 6        |
| 051346          | ● Yellow | 38.00               | 6.50                  | 20.00                  | 33.00              | 19.50      | 86.50       | 38.50      | 6        |

\*Optional Engraving on Front & Back

## Traditional Nylon Padlocks with nylon shackle



Consult the technical datasheet LOTO-6 on [bradyeurope.com/tds](http://bradyeurope.com/tds)



| Order Reference | Colour   | Shackle Height (mm) | Shackle Diameter (mm) | Shackle Clearance (mm) | Shackle Width (mm) | Depth (mm) | Height (mm) | Width (mm) | Quantity |
|-----------------|----------|---------------------|-----------------------|------------------------|--------------------|------------|-------------|------------|----------|
| 813595          | ● Black  | 38.00               | 6.50                  | 20.00                  | 33.00              | 19.50      | 86.50       | 38.00      | 6        |
| 813593          | ● Blue   | 38.00               | 6.50                  | 20.00                  | 33.00              | 19.50      | 86.50       | 38.00      | 6        |
| 813639          | ● Brown  | 38.00               | 6.50                  | 20.00                  | 33.00              | 19.50      | 86.50       | 38.00      | 6        |
| 813597          | ● Green  | 38.00               | 6.50                  | 20.00                  | 33.00              | 19.50      | 86.50       | 38.00      | 6        |
| 814154          | ● Grey   | 38.00               | 6.50                  | 20.00                  | 33.00              | 19.50      | 86.50       | 38.00      | 6        |
| 813598          | ● Orange | 38.00               | 6.50                  | 20.00                  | 33.00              | 19.50      | 86.50       | 38.00      | 6        |
| 813640          | ● Purple | 38.00               | 6.50                  | 20.00                  | 33.00              | 19.50      | 86.50       | 38.00      | 6        |
| 813594**        | ● Red    | 38.00               | 6.50                  | 20.00                  | 33.00              | 19.50      | 86.50       | 38.00      | 6        |
| 813641          | ○ White  | 38.00               | 6.50                  | 20.00                  | 33.00              | 19.50      | 86.50       | 38.00      | 6        |
| 813596          | ● Yellow | 38.00               | 6.50                  | 20.00                  | 33.00              | 19.50      | 86.50       | 38.00      | 6        |

\*Optional Engraving on Front & Back

\*\*These products meet the ATEX Equipment Directive.

## Traditional Nylon Long Body Padlocks with hardened steel shackle



| Order Reference | Colour   | Shackle Height (mm) | Shackle Diameter (mm) | Shackle Clearance (mm) | Shackle Width (mm) | Depth (mm) | Height (mm) | Width (mm) | Quantity |
|-----------------|----------|---------------------|-----------------------|------------------------|--------------------|------------|-------------|------------|----------|
| 834463          | ● Black  | 38.00               | 6.50                  | 20.00                  | 33.00              | 19.50      | 122.00      | 38.00      | 6        |
| 834462          | ● Blue   | 38.00               | 6.50                  | 20.00                  | 33.00              | 19.50      | 122.00      | 38.00      | 6        |
| 834466          | ● Green  | 38.00               | 6.50                  | 20.00                  | 33.00              | 19.50      | 122.00      | 38.00      | 6        |
| 834467          | ● Orange | 38.00               | 6.50                  | 20.00                  | 33.00              | 19.50      | 122.00      | 38.00      | 6        |
| 834464          | ● Red    | 38.00               | 6.50                  | 20.00                  | 33.00              | 19.50      | 122.00      | 38.00      | 6        |
| 834465          | ● Yellow | 38.00               | 6.50                  | 20.00                  | 33.00              | 19.50      | 122.00      | 38.00      | 6        |

Long Body version: Purple, Brown, Grey and White colours available upon request for large volumes.

\*Optional Engraving on Front, Back & Sides

## SafeKey Nylon Compact Padlocks

- Extremely compact and lightweight design
- Non-conductive and non-sparking nylon body and polymer shackle
- Non-conductive locking mechanism
- Ideal for electrical applications and small spaces
- Ribbed design for safe handling
- For electrical contractors, maintenance and electricians

1 key supplied for each padlock. Custom keying options available.  
 Supplied with padlock labels in English, French and Spanish.  
 Engraving on front, back, left side, right side and key.



 Consult the technical datasheet LOTO-100 on [bradyeurope.com/tds](http://bradyeurope.com/tds)

 The compact safety padlock is perfect for small space applications and where lightweight and easy to carry locks are needed. For even more durable applications, please refer to Brady's range of padlocks with 6.50 mm diam shackles for more durability.

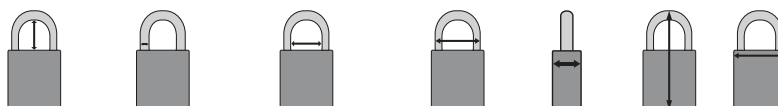

| Order Reference  | Colour   | Shackle Height (mm) | Shackle Diameter (mm) | Shackle Clearance (mm) | Shackle Width (mm) | Depth (mm) | Height (mm) | Width (mm) | Quantity |
|--|----------|---------------------|-----------------------|------------------------|--------------------|------------|-------------|------------|----------|
| <b>Shackle Height 25 mm / KA - Keyed Alike / pack of 3</b>       |          |                     |                       |                        |                    |            |             |            |          |
| 150193   | ● Black  | 25.00               | 4.30                  | 18.00                  | 26.00              | 19.00      | 67.00       | 33.00      | 3        |
| 150192   | ● Blue   | 25.00               | 4.30                  | 18.00                  | 26.00              | 19.00      | 67.00       | 33.00      | 3        |
| 150196   | ● Brown  | 25.00               | 4.30                  | 18.00                  | 26.00              | 19.00      | 67.00       | 33.00      | 3        |
| 150191   | ● Green  | 25.00               | 4.30                  | 18.00                  | 26.00              | 19.00      | 67.00       | 33.00      | 3        |
| 150194   | ● Orange | 25.00               | 4.30                  | 18.00                  | 26.00              | 19.00      | 67.00       | 33.00      | 3        |
| 150195   | ● Purple | 25.00               | 4.30                  | 18.00                  | 26.00              | 19.00      | 67.00       | 33.00      | 3        |
| 150189   | ● Red    | 25.00               | 4.30                  | 18.00                  | 26.00              | 19.00      | 67.00       | 33.00      | 3        |
| 150197   | ○ White  | 25.00               | 4.30                  | 18.00                  | 26.00              | 19.00      | 67.00       | 33.00      | 3        |
| 150190   | ● Yellow | 25.00               | 4.30                  | 18.00                  | 26.00              | 19.00      | 67.00       | 33.00      | 3        |
| <b>Shackle Height 25 mm / KD - Keyed Differently / pack of 1</b> |          |                     |                       |                        |                    |            |             |            |          |
| 150184   | ● Black  | 25.00               | 4.30                  | 18.00                  | 26.00              | 19.00      | 67.00       | 33.00      | 1        |
| 150183   | ● Blue   | 25.00               | 4.30                  | 18.00                  | 26.00              | 19.00      | 67.00       | 33.00      | 1        |
| 150187   | ● Brown  | 25.00               | 4.30                  | 18.00                  | 26.00              | 19.00      | 67.00       | 33.00      | 1        |
| 150182   | ● Green  | 25.00               | 4.30                  | 18.00                  | 26.00              | 19.00      | 67.00       | 33.00      | 1        |
| 150185   | ● Orange | 25.00               | 4.30                  | 18.00                  | 26.00              | 19.00      | 67.00       | 33.00      | 1        |
| 150186   | ● Purple | 25.00               | 4.30                  | 18.00                  | 26.00              | 19.00      | 67.00       | 33.00      | 1        |
| 150180   | ● Red    | 25.00               | 4.30                  | 18.00                  | 26.00              | 19.00      | 67.00       | 33.00      | 1        |
| 150188   | ○ White  | 25.00               | 4.30                  | 18.00                  | 26.00              | 19.00      | 67.00       | 33.00      | 1        |
| 150181   | ● Yellow | 25.00               | 4.30                  | 18.00                  | 26.00              | 19.00      | 67.00       | 33.00      | 1        |
| <b>Shackle Height 25 mm / KD - Keyed Differently / pack of 6</b> |          |                     |                       |                        |                    |            |             |            |          |
| 150211   | ● Black  | 25.00               | 4.30                  | 18.00                  | 26.00              | 19.00      | 67.00       | 33.00      | 6        |
| 150210   | ● Blue   | 25.00               | 4.30                  | 18.00                  | 26.00              | 19.00      | 67.00       | 33.00      | 6        |
| 150214   | ● Brown  | 25.00               | 4.30                  | 18.00                  | 26.00              | 19.00      | 67.00       | 33.00      | 6        |
| 150209   | ● Green  | 25.00               | 4.30                  | 18.00                  | 26.00              | 19.00      | 67.00       | 33.00      | 6        |
| 150212   | ● Orange | 25.00               | 4.30                  | 18.00                  | 26.00              | 19.00      | 67.00       | 33.00      | 6        |
| 150213   | ● Purple | 25.00               | 4.30                  | 18.00                  | 26.00              | 19.00      | 67.00       | 33.00      | 6        |
| 150207   | ● Red    | 25.00               | 4.30                  | 18.00                  | 26.00              | 19.00      | 67.00       | 33.00      | 6        |
| 150215   | ○ White  | 25.00               | 4.30                  | 18.00                  | 26.00              | 19.00      | 67.00       | 33.00      | 6        |
| 150208   | ● Yellow | 25.00               | 4.30                  | 18.00                  | 26.00              | 19.00      | 67.00       | 33.00      | 6        |



# Traditional Nylon Compact Padlocks



## Traditional Nylon Compact Padlocks

Compact & Lightweight padlocks - easy to use for effective energy control!

- Non-conductive nylon body and aluminium shackle
- Minimum weight for padlock is only 40 g
- Key retaining system
- Maximum Operation Temperature 120 °C
- Colour coding allows for easy identification of Lockout teams during maintenance programmes
- Small shackle diameter ideal for lockout ready equipment with 5 mm holes
- Optional Laser Engraving on Front, Back & Sides

Locks are supplied keyed different. 1 key supplied with each padlock.

Custom keying options available. Supplied with Padlock labels in English/French.

**i** The compact safety padlock is perfect for small space applications and where lightweight and easy to carry locks are needed. For even more durable applications, please refer to Brady's range of padlocks with 6.50 mm diam shackles for more durability.

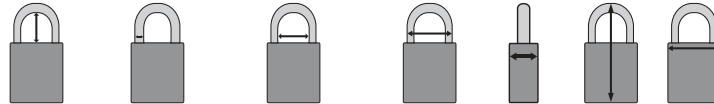

| Order Reference             | Colour   | Shackle Height (mm) | Shackle Diameter (mm) | Shackle Clearance (mm) | Shackle Width (mm) | Depth (mm) | Height (mm) | Width (mm) | Quantity |
|-----------------------------|----------|---------------------|-----------------------|------------------------|--------------------|------------|-------------|------------|----------|
| <b>Shackle Height 25 mm</b> |          |                     |                       |                        |                    |            |             |            |          |
| 814115                      | ● Black  | 25.00               | 4.70                  | 17.00                  | 26.00              | 16.00      | 64.00       | 32.00      | 6        |
| 814114                      | ● Blue   | 25.00               | 4.70                  | 17.00                  | 26.00              | 16.00      | 64.00       | 32.00      | 6        |
| 814120                      | ● Brown  | 25.00               | 4.70                  | 17.00                  | 26.00              | 16.00      | 64.00       | 32.00      | 6        |
| 814118                      | ● Green  | 25.00               | 4.70                  | 17.00                  | 26.00              | 16.00      | 64.00       | 32.00      | 6        |
| 814123                      | ● Grey   | 25.00               | 4.70                  | 17.00                  | 26.00              | 16.00      | 64.00       | 32.00      | 6        |
| 814119                      | ● Orange | 25.00               | 4.70                  | 17.00                  | 26.00              | 16.00      | 64.00       | 32.00      | 6        |
| 814121                      | ● Purple | 25.00               | 4.70                  | 17.00                  | 26.00              | 16.00      | 64.00       | 32.00      | 6        |
| 814116*                     | ● Red    | 25.00               | 4.70                  | 17.00                  | 26.00              | 16.00      | 64.00       | 32.00      | 6        |
| 814122                      | ○ White  | 25.00               | 4.70                  | 17.00                  | 26.00              | 16.00      | 64.00       | 32.00      | 6        |
| 814117                      | ● Yellow | 25.00               | 4.70                  | 17.00                  | 26.00              | 16.00      | 64.00       | 32.00      | 6        |
| <b>Shackle Height 38 mm</b> |          |                     |                       |                        |                    |            |             |            |          |
| 814125                      | ● Black  | 38.00               | 4.70                  | 17.00                  | 26.00              | 16.00      | 77.00       | 32.00      | 6        |
| 814124                      | ● Blue   | 38.00               | 4.70                  | 17.00                  | 26.00              | 16.00      | 77.00       | 32.00      | 6        |
| 814130                      | ● Brown  | 38.00               | 4.70                  | 17.00                  | 26.00              | 16.00      | 77.00       | 32.00      | 6        |
| 814128                      | ● Green  | 38.00               | 4.70                  | 17.00                  | 26.00              | 16.00      | 77.00       | 32.00      | 6        |
| 814133                      | ● Grey   | 38.00               | 4.70                  | 17.00                  | 26.00              | 16.00      | 77.00       | 32.00      | 6        |
| 814129                      | ● Orange | 38.00               | 4.70                  | 17.00                  | 26.00              | 16.00      | 77.00       | 32.00      | 6        |
| 814131                      | ● Purple | 38.00               | 4.70                  | 17.00                  | 26.00              | 16.00      | 77.00       | 32.00      | 6        |
| 814126*                     | ● Red    | 38.00               | 4.70                  | 17.00                  | 26.00              | 16.00      | 77.00       | 32.00      | 6        |
| 814132                      | ○ White  | 38.00               | 4.70                  | 17.00                  | 26.00              | 16.00      | 77.00       | 32.00      | 6        |
| 814127                      | ● Yellow | 38.00               | 4.70                  | 17.00                  | 26.00              | 16.00      | 77.00       | 32.00      | 6        |
| <b>Shackle Height 50 mm</b> |          |                     |                       |                        |                    |            |             |            |          |
| 814135                      | ● Black  | 50.00               | 4.70                  | 17.00                  | 26.00              | 16.00      | 99.00       | 32.00      | 6        |
| 814134                      | ● Blue   | 50.00               | 4.70                  | 17.00                  | 26.00              | 16.00      | 99.00       | 32.00      | 6        |
| 814140                      | ● Brown  | 50.00               | 4.70                  | 17.00                  | 26.00              | 16.00      | 99.00       | 32.00      | 6        |
| 814138                      | ● Green  | 50.00               | 4.70                  | 17.00                  | 26.00              | 16.00      | 99.00       | 32.00      | 6        |
| 814143                      | ● Grey   | 50.00               | 4.70                  | 17.00                  | 26.00              | 16.00      | 99.00       | 32.00      | 6        |
| 814139                      | ● Orange | 50.00               | 4.70                  | 17.00                  | 26.00              | 16.00      | 99.00       | 32.00      | 6        |
| 814141                      | ● Purple | 50.00               | 4.70                  | 17.00                  | 26.00              | 16.00      | 99.00       | 32.00      | 6        |
| 814136*                     | ● Red    | 50.00               | 4.70                  | 17.00                  | 26.00              | 16.00      | 99.00       | 32.00      | 6        |
| 814142                      | ○ White  | 50.00               | 4.70                  | 17.00                  | 26.00              | 16.00      | 99.00       | 32.00      | 6        |
| 814137                      | ● Yellow | 50.00               | 4.70                  | 17.00                  | 26.00              | 16.00      | 99.00       | 32.00      | 6        |
| <b>Shackle Height 75 mm</b> |          |                     |                       |                        |                    |            |             |            |          |
| 814145                      | ● Black  | 75.00               | 4.70                  | 17.00                  | 26.00              | 16.00      | 114.00      | 32.00      | 6        |
| 814144                      | ● Blue   | 75.00               | 4.70                  | 17.00                  | 26.00              | 16.00      | 114.00      | 32.00      | 6        |
| 814150                      | ● Brown  | 75.00               | 4.70                  | 17.00                  | 26.00              | 16.00      | 114.00      | 32.00      | 6        |
| 814148                      | ● Green  | 75.00               | 4.70                  | 17.00                  | 26.00              | 16.00      | 114.00      | 32.00      | 6        |
| 814153                      | ● Grey   | 75.00               | 4.70                  | 17.00                  | 26.00              | 16.00      | 114.00      | 32.00      | 6        |
| 814149                      | ● Orange | 75.00               | 4.70                  | 17.00                  | 26.00              | 16.00      | 114.00      | 32.00      | 6        |
| 814151                      | ● Purple | 75.00               | 4.70                  | 17.00                  | 26.00              | 16.00      | 114.00      | 32.00      | 6        |
| 814146*                     | ● Red    | 75.00               | 4.70                  | 17.00                  | 26.00              | 16.00      | 114.00      | 32.00      | 6        |
| 814152                      | ○ White  | 75.00               | 4.70                  | 17.00                  | 26.00              | 16.00      | 114.00      | 32.00      | 6        |
| 814147                      | ● Yellow | 75.00               | 4.70                  | 17.00                  | 26.00              | 16.00      | 114.00      | 32.00      | 6        |

\*This product meets the ATEX Equipment Directive

## Traditional Nylon Compact Cable Padlocks

Compact & Lightweight padlocks - easy to use for effective energy control!

- Non-conductive nylon body and PVC encased steel cable
- Minimum weight for padlock is only 40 g
- Key retaining system
- Maximum Operation Temperature 120 °C
- Small cable diameter ideal for lockout ready equipment with 5 mm holes close to each other
- Optional Laser Engraving on Front, Back & Sides

Locks are supplied keyed different or keyed alike. 1 key supplied with each padlock.  
Custom keying options available. Supplied with Padlock labels in English/French.



| Order Reference               | Colour | Shackle Height (mm) | Shackle Diameter (mm) | Shackle Clearance (mm) | Shackle Width (mm) | Depth (mm) | Width (mm) | Quantity |
|-------------------------------|--------|---------------------|-----------------------|------------------------|--------------------|------------|------------|----------|
| <b>Cable length 200 mm</b>    |        |                     |                       |                        |                    |            |            |          |
| <b>KA - Keyed Alike</b>       |        |                     |                       |                        |                    |            |            |          |
| 146128                        | Red    | 106.68              | 4.70                  | 17.00                  | 26.00              | 16.00      | 32.00      | 6        |
| 146129                        | Yellow | 106.68              | 4.70                  | 17.00                  | 26.00              | 16.00      | 32.00      | 6        |
| 146130                        | Blue   | 106.68              | 4.70                  | 17.00                  | 26.00              | 16.00      | 32.00      | 6        |
| 146131                        | Green  | 106.68              | 4.70                  | 17.00                  | 26.00              | 16.00      | 32.00      | 6        |
| 195946                        | Black  | 106.68              | 4.70                  | 17.00                  | 26.00              | 16.00      | 32.00      | 6        |
| 195947                        | Brown  | 106.68              | 4.70                  | 17.00                  | 26.00              | 16.00      | 32.00      | 6        |
| 195948                        | Grey   | 106.68              | 4.70                  | 17.00                  | 26.00              | 16.00      | 32.00      | 6        |
| 195949                        | Orange | 106.68              | 4.70                  | 17.00                  | 26.00              | 16.00      | 32.00      | 6        |
| 195950                        | Purple | 106.68              | 4.70                  | 17.00                  | 26.00              | 16.00      | 32.00      | 6        |
| 195951                        | White  | 106.68              | 4.70                  | 17.00                  | 26.00              | 16.00      | 32.00      | 6        |
| <b>KD - Keyed Differently</b> |        |                     |                       |                        |                    |            |            |          |
| 146120                        | Red    | 106.68              | 4.70                  | 17.00                  | 26.00              | 16.00      | 32.00      | 1        |
| 146121                        | Yellow | 106.68              | 4.70                  | 17.00                  | 26.00              | 16.00      | 32.00      | 1        |
| 146122                        | Blue   | 106.68              | 4.70                  | 17.00                  | 26.00              | 16.00      | 32.00      | 1        |
| 146123                        | Green  | 106.68              | 4.70                  | 17.00                  | 26.00              | 16.00      | 32.00      | 1        |
| 195934                        | Black  | 106.68              | 4.70                  | 17.00                  | 26.00              | 16.00      | 32.00      | 1        |
| 195935                        | Brown  | 106.68              | 4.70                  | 17.00                  | 26.00              | 16.00      | 32.00      | 1        |
| 195936                        | Grey   | 106.68              | 4.70                  | 17.00                  | 26.00              | 16.00      | 32.00      | 1        |
| 195937                        | Orange | 106.68              | 4.70                  | 17.00                  | 26.00              | 16.00      | 32.00      | 1        |
| 195938                        | Purple | 106.68              | 4.70                  | 17.00                  | 26.00              | 16.00      | 32.00      | 1        |
| 195939                        | White  | 106.68              | 4.70                  | 17.00                  | 26.00              | 16.00      | 32.00      | 1        |
| 195972                        | Red    | 106.68              | 4.70                  | 17.00                  | 26.00              | 16.00      | 32.00      | 6        |
| 195973                        | Yellow | 106.68              | 4.70                  | 17.00                  | 26.00              | 16.00      | 32.00      | 6        |
| 195974                        | Blue   | 106.68              | 4.70                  | 17.00                  | 26.00              | 16.00      | 32.00      | 6        |
| 195975                        | Green  | 106.68              | 4.70                  | 17.00                  | 26.00              | 16.00      | 32.00      | 6        |
| 195980                        | Black  | 106.68              | 4.70                  | 17.00                  | 26.00              | 16.00      | 32.00      | 6        |
| 195981                        | Brown  | 106.68              | 4.70                  | 17.00                  | 26.00              | 16.00      | 32.00      | 6        |
| 195982                        | Grey   | 106.68              | 4.70                  | 17.00                  | 26.00              | 16.00      | 32.00      | 6        |
| 195983                        | Orange | 106.68              | 4.70                  | 17.00                  | 26.00              | 16.00      | 32.00      | 6        |
| 195984                        | Purple | 106.68              | 4.70                  | 17.00                  | 26.00              | 16.00      | 32.00      | 6        |
| 195985                        | White  | 106.68              | 4.70                  | 17.00                  | 26.00              | 16.00      | 32.00      | 6        |
| <b>Cable length 400 mm</b>    |        |                     |                       |                        |                    |            |            |          |
| <b>KA - Keyed Alike</b>       |        |                     |                       |                        |                    |            |            |          |
| 146132                        | Red    | 203.20              | 4.70                  | 17.00                  | 26.00              | 16.00      | 32.00      | 6        |
| 146133                        | Yellow | 203.20              | 4.70                  | 17.00                  | 26.00              | 16.00      | 32.00      | 6        |
| 146134                        | Blue   | 203.20              | 4.70                  | 17.00                  | 26.00              | 16.00      | 32.00      | 6        |
| 146135                        | Green  | 203.20              | 4.70                  | 17.00                  | 26.00              | 16.00      | 32.00      | 6        |
| 195952                        | Black  | 203.20              | 4.70                  | 17.00                  | 26.00              | 16.00      | 32.00      | 6        |
| 195953                        | Brown  | 203.20              | 4.70                  | 17.00                  | 26.00              | 16.00      | 32.00      | 6        |
| 195954                        | Grey   | 203.20              | 4.70                  | 17.00                  | 26.00              | 16.00      | 32.00      | 6        |
| 195955                        | Orange | 203.20              | 4.70                  | 17.00                  | 26.00              | 16.00      | 32.00      | 6        |
| 195956                        | Purple | 203.20              | 4.70                  | 17.00                  | 26.00              | 16.00      | 32.00      | 6        |
| 195957                        | White  | 203.20              | 4.70                  | 17.00                  | 26.00              | 16.00      | 32.00      | 6        |
| <b>KD - Keyed Differently</b> |        |                     |                       |                        |                    |            |            |          |
| 146124                        | Red    | 203.20              | 4.70                  | 17.00                  | 26.00              | 16.00      | 32.00      | 1        |
| 146125                        | Yellow | 203.20              | 4.70                  | 17.00                  | 26.00              | 16.00      | 32.00      | 1        |
| 146126                        | Blue   | 203.20              | 4.70                  | 17.00                  | 26.00              | 16.00      | 32.00      | 1        |
| 146127                        | Green  | 203.20              | 4.70                  | 17.00                  | 26.00              | 16.00      | 32.00      | 1        |
| 195940                        | Black  | 203.20              | 4.70                  | 17.00                  | 26.00              | 16.00      | 32.00      | 1        |
| 195941                        | Brown  | 203.20              | 4.70                  | 17.00                  | 26.00              | 16.00      | 32.00      | 1        |
| 195942                        | Grey   | 203.20              | 4.70                  | 17.00                  | 26.00              | 16.00      | 32.00      | 1        |
| 195943                        | Orange | 203.20              | 4.70                  | 17.00                  | 26.00              | 16.00      | 32.00      | 1        |
| 195944                        | Purple | 203.20              | 4.70                  | 17.00                  | 26.00              | 16.00      | 32.00      | 1        |
| 195945                        | White  | 203.20              | 4.70                  | 17.00                  | 26.00              | 16.00      | 32.00      | 1        |
| 195976                        | Red    | 203.20              | 4.70                  | 17.00                  | 26.00              | 16.00      | 32.00      | 6        |
| 195977                        | Yellow | 203.20              | 4.70                  | 17.00                  | 26.00              | 16.00      | 32.00      | 6        |
| 195978                        | Blue   | 203.20              | 4.70                  | 17.00                  | 26.00              | 16.00      | 32.00      | 6        |
| 195979                        | Green  | 203.20              | 4.70                  | 17.00                  | 26.00              | 16.00      | 32.00      | 6        |
| 195986                        | Black  | 203.20              | 4.70                  | 17.00                  | 26.00              | 16.00      | 32.00      | 6        |
| 195987                        | Brown  | 203.20              | 4.70                  | 17.00                  | 26.00              | 16.00      | 32.00      | 6        |
| 195988                        | Grey   | 203.20              | 4.70                  | 17.00                  | 26.00              | 16.00      | 32.00      | 6        |
| 195989                        | Orange | 203.20              | 4.70                  | 17.00                  | 26.00              | 16.00      | 32.00      | 6        |
| 195990                        | Purple | 203.20              | 4.70                  | 17.00                  | 26.00              | 16.00      | 32.00      | 6        |
| 195991                        | White  | 203.20              | 4.70                  | 17.00                  | 26.00              | 16.00      | 32.00      | 6        |



## Safety Security Padlocks

Nylon encased aluminium body with nylon encased steel shackle

- Solid aluminium core with steel shackle for best physical strength
- Body and shackle insulated against electric shock
- NANO PROTECT™ shackle for superior corrosion resistance
- Intrinsically safe
- Automatic locking for user convenience
- Compact and lightweight
- High precision 6-pin cylinder for better tamper-resistance
- Long Body version available on request (bilingual labelling)
- Key retaining system (Key won't release until padlock shackle is correctly closed, non-key retaining available upon request)
- Optional Engraving on Front, Back & Sides

**Locks are supplied keyed different. 1 key supplied with each padlock.**

**Custom keying options available.**

**Supplied with Padlock labels in English/French/Spanish.**

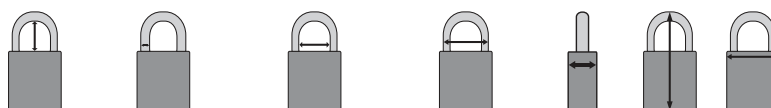

| Order Reference             | Colour   | Shackle Height (mm) | Shackle Diameter (mm) | Shackle Clearance (mm) | Shackle Width (mm) | Depth (mm) | Height (mm) | Width (mm) | Quantity |
|-----------------------------|----------|---------------------|-----------------------|------------------------|--------------------|------------|-------------|------------|----------|
| <b>Shackle Height 38 mm</b> |          |                     |                       |                        |                    |            |             |            |          |
| 834469                      | ● Black  | 38.00               | 6.50                  | 20.00                  | 33.00              | 20.00      | 90.00       | 40.00      | 6        |
| 834468                      | ● Blue   | 38.00               | 6.50                  | 20.00                  | 33.00              | 20.00      | 90.00       | 40.00      | 6        |
| 834472                      | ● Green  | 38.00               | 6.50                  | 20.00                  | 33.00              | 20.00      | 90.00       | 40.00      | 6        |
| 834473                      | ● Orange | 38.00               | 6.50                  | 20.00                  | 33.00              | 20.00      | 90.00       | 40.00      | 6        |
| 834470                      | ● Red    | 38.00               | 6.50                  | 20.00                  | 33.00              | 20.00      | 90.00       | 40.00      | 6        |
| 834471                      | ● Yellow | 38.00               | 6.50                  | 20.00                  | 33.00              | 20.00      | 90.00       | 40.00      | 6        |
| <b>Shackle Height 75 mm</b> |          |                     |                       |                        |                    |            |             |            |          |
| 834475                      | ● Black  | 75.00               | 6.50                  | 20.00                  | 33.00              | 20.00      | 127.00      | 40.00      | 6        |
| 834474                      | ● Blue   | 75.00               | 6.50                  | 20.00                  | 33.00              | 20.00      | 127.00      | 40.00      | 6        |
| 834478                      | ● Green  | 75.00               | 6.50                  | 20.00                  | 33.00              | 20.00      | 127.00      | 40.00      | 6        |
| 834479                      | ● Orange | 75.00               | 6.50                  | 20.00                  | 33.00              | 20.00      | 127.00      | 40.00      | 6        |
| 834476                      | ● Red    | 75.00               | 6.50                  | 20.00                  | 33.00              | 20.00      | 127.00      | 40.00      | 6        |
| 834477                      | ● Yellow | 75.00               | 6.50                  | 20.00                  | 33.00              | 20.00      | 127.00      | 40.00      | 6        |

Purple, Brown, Grey and White colours available upon request for large volumes.



## Brass Padlocks

Locks that will never rust

- Solid brass body and shackle
- Spark resistant ideal for use in flammable environments
- Corrosion resistant
- 6-pin cylinder offers more unique key cuts, better tamper-resistance
- Locks protected by coloured vinyl sheaths
- Non-key retaining, key retaining upon request (Key won't release until padlock shackle is correctly closed)
- Optional Engraving on Bottom & Key

**Locks are supplied keyed different. Two keys supplied with each padlock.**

**Custom keying options available.**



| Order Reference | Colour   | Shackle Height (mm) | Shackle Diameter (mm) | Shackle Clearance (mm) | Shackle Width (mm) | Depth (mm) | Height (mm) | Width (mm) | Quantity |
|-----------------|----------|---------------------|-----------------------|------------------------|--------------------|------------|-------------|------------|----------|
| 051359          | ● Black  | 21.00               | 6.50                  | 20.50                  | 33.50              | 17.00      | 60.00       | 43.00      | 12       |
| 051355          | ● Blue   | 21.00               | 6.50                  | 20.50                  | 33.50              | 17.00      | 60.00       | 43.00      | 12       |
| 051356          | ● Green  | 21.00               | 6.50                  | 20.50                  | 33.50              | 17.00      | 60.00       | 43.00      | 12       |
| 051358          | ● Grey   | 21.00               | 6.50                  | 20.50                  | 33.50              | 17.00      | 60.00       | 43.00      | 12       |
| 051354*         | ● Red    | 21.00               | 6.50                  | 20.50                  | 33.50              | 17.00      | 60.00       | 43.00      | 12       |
| 051357          | ● Yellow | 21.00               | 6.50                  | 20.50                  | 33.50              | 17.00      | 60.00       | 43.00      | 12       |

\*This product meets the ATEX Equipment Directive.

## SafeKey Aluminum Padlocks with steel shackle

- Aluminum padlock with steel shackle provides corrosion resistance
- Non-conductive locking mechanism
- Ideal for indoor and outdoor use, and heavy-duty applications
- Not key-retaining

1 key supplied for each padlock.  
Custom keying options available.

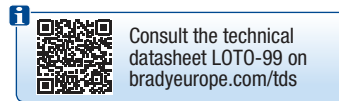

| Order Reference  | Colour   | Shackle Height (mm) | Shackle Diameter (mm) | Shackle Clearance (mm) | Shackle Width (mm) | Depth (mm) | Height (mm) | Width (mm) | Quantity |
|--|----------|---------------------|-----------------------|------------------------|--------------------|------------|-------------|------------|----------|
| <b>Shackle Height 38 mm / KA - Keyed Alike / pack of 3</b>       |          |                     |                       |                        |                    |            |             |            |          |
| 150349   | ● Black  | 38.00               | 6.40                  | 20.00                  | 33.00              | 19.00      | 84.00       | 38.00      | 3        |
| 150261   | ● Blue   | 38.00               | 6.40                  | 20.00                  | 33.00              | 19.00      | 84.00       | 38.00      | 3        |
| 150260   | ● Brown  | 38.00               | 6.40                  | 20.00                  | 33.00              | 19.00      | 84.00       | 38.00      | 3        |
| 150281   | ● Green  | 38.00               | 6.40                  | 20.00                  | 33.00              | 19.00      | 84.00       | 38.00      | 3        |
| 150305   | ● Orange | 38.00               | 6.40                  | 20.00                  | 33.00              | 19.00      | 84.00       | 38.00      | 3        |
| 150348   | ● Purple | 38.00               | 6.40                  | 20.00                  | 33.00              | 19.00      | 84.00       | 38.00      | 3        |
| 150262   | ● Red    | 38.00               | 6.40                  | 20.00                  | 33.00              | 19.00      | 84.00       | 38.00      | 3        |
| 150304   | ● Silver | 38.00               | 6.40                  | 20.00                  | 33.00              | 19.00      | 84.00       | 38.00      | 3        |
| 150282   | ● Yellow | 38.00               | 6.40                  | 20.00                  | 33.00              | 19.00      | 84.00       | 38.00      | 3        |
| <b>Shackle Height 38 mm / KD - Keyed Differently / pack of 1</b> |          |                     |                       |                        |                    |            |             |            |          |
| 150243   | ● Black  | 38.00               | 6.40                  | 20.00                  | 33.00              | 19.00      | 84.00       | 38.00      | 1        |
| 150287   | ● Blue   | 38.00               | 6.40                  | 20.00                  | 33.00              | 19.00      | 84.00       | 38.00      | 1        |
| 150286   | ● Brown  | 38.00               | 6.40                  | 20.00                  | 33.00              | 19.00      | 84.00       | 38.00      | 1        |
| 150264   | ● Green  | 38.00               | 6.40                  | 20.00                  | 33.00              | 19.00      | 84.00       | 38.00      | 1        |
| 150263   | ● Orange | 38.00               | 6.40                  | 20.00                  | 33.00              | 19.00      | 84.00       | 38.00      | 1        |
| 150333   | ● Purple | 38.00               | 6.40                  | 20.00                  | 33.00              | 19.00      | 84.00       | 38.00      | 1        |
| 150307   | ● Red    | 38.00               | 6.40                  | 20.00                  | 33.00              | 19.00      | 84.00       | 38.00      | 1        |
| 150242   | ● Silver | 38.00               | 6.40                  | 20.00                  | 33.00              | 19.00      | 84.00       | 38.00      | 1        |
| 150288   | ● Yellow | 38.00               | 6.40                  | 20.00                  | 33.00              | 19.00      | 84.00       | 38.00      | 1        |
| <b>Shackle Height 38 mm / KD - Keyed Differently / pack of 6</b> |          |                     |                       |                        |                    |            |             |            |          |
| 150240   | ● Black  | 38.00               | 6.40                  | 20.00                  | 33.00              | 19.00      | 84.00       | 38.00      | 6        |
| 150302   | ● Blue   | 38.00               | 6.40                  | 20.00                  | 33.00              | 19.00      | 84.00       | 38.00      | 6        |
| 150301   | ● Brown  | 38.00               | 6.40                  | 20.00                  | 33.00              | 19.00      | 84.00       | 38.00      | 6        |
| 150256   | ● Green  | 38.00               | 6.40                  | 20.00                  | 33.00              | 19.00      | 84.00       | 38.00      | 6        |
| 150326   | ● Orange | 38.00               | 6.40                  | 20.00                  | 33.00              | 19.00      | 84.00       | 38.00      | 6        |
| 150347   | ● Purple | 38.00               | 6.40                  | 20.00                  | 33.00              | 19.00      | 84.00       | 38.00      | 6        |
| 150303   | ● Red    | 38.00               | 6.40                  | 20.00                  | 33.00              | 19.00      | 84.00       | 38.00      | 6        |
| 150278   | ● Silver | 38.00               | 6.40                  | 20.00                  | 33.00              | 19.00      | 84.00       | 38.00      | 6        |
| 150219   | ● Yellow | 38.00               | 6.40                  | 20.00                  | 33.00              | 19.00      | 84.00       | 38.00      | 6        |
| <b>Shackle Height 76 mm / KA - Keyed Alike / pack of 3</b>       |          |                     |                       |                        |                    |            |             |            |          |
| 150217   | ● Black  | 76.00               | 6.40                  | 20.00                  | 33.00              | 19.00      | 122.00      | 38.00      | 3        |
| 150277   | ● Blue   | 76.00               | 6.40                  | 20.00                  | 33.00              | 19.00      | 122.00      | 38.00      | 3        |
| 150299   | ● Brown  | 76.00               | 6.40                  | 20.00                  | 33.00              | 19.00      | 122.00      | 38.00      | 3        |
| 150238   | ● Green  | 76.00               | 6.40                  | 20.00                  | 33.00              | 19.00      | 122.00      | 38.00      | 3        |
| 150325   | ● Orange | 76.00               | 6.40                  | 20.00                  | 33.00              | 19.00      | 122.00      | 38.00      | 3        |
| 150300   | ● Purple | 76.00               | 6.40                  | 20.00                  | 33.00              | 19.00      | 122.00      | 38.00      | 3        |
| 150218   | ● Red    | 76.00               | 6.40                  | 20.00                  | 33.00              | 19.00      | 122.00      | 38.00      | 3        |
| 150276   | ● Silver | 76.00               | 6.40                  | 20.00                  | 33.00              | 19.00      | 122.00      | 38.00      | 3        |
| 150239   | ● Yellow | 76.00               | 6.40                  | 20.00                  | 33.00              | 19.00      | 122.00      | 38.00      | 3        |
| <b>Shackle Height 76 mm / KD - Keyed Differently / pack of 1</b> |          |                     |                       |                        |                    |            |             |            |          |
| 150331   | ● Black  | 76.00               | 6.40                  | 20.00                  | 33.00              | 19.00      | 122.00      | 38.00      | 1        |
| 150241   | ● Blue   | 76.00               | 6.40                  | 20.00                  | 33.00              | 19.00      | 122.00      | 38.00      | 1        |
| 150284   | ● Brown  | 76.00               | 6.40                  | 20.00                  | 33.00              | 19.00      | 122.00      | 38.00      | 1        |
| 150360   | ● Green  | 76.00               | 6.40                  | 20.00                  | 33.00              | 19.00      | 122.00      | 38.00      | 1        |
| 150306   | ● Orange | 76.00               | 6.40                  | 20.00                  | 33.00              | 19.00      | 122.00      | 38.00      | 1        |
| 150330   | ● Purple | 76.00               | 6.40                  | 20.00                  | 33.00              | 19.00      | 122.00      | 38.00      | 1        |
| 150332   | ● Red    | 76.00               | 6.40                  | 20.00                  | 33.00              | 19.00      | 122.00      | 38.00      | 1        |
| 150283   | ● Silver | 76.00               | 6.40                  | 20.00                  | 33.00              | 19.00      | 122.00      | 38.00      | 1        |
| 150285   | ● Yellow | 76.00               | 6.40                  | 20.00                  | 33.00              | 19.00      | 122.00      | 38.00      | 1        |
| <b>Shackle Height 76 mm / KD - Keyed Differently / pack of 6</b> |          |                     |                       |                        |                    |            |             |            |          |
| 150216   | ● Black  | 76.00               | 6.40                  | 20.00                  | 33.00              | 19.00      | 122.00      | 38.00      | 6        |
| 150322   | ● Blue   | 76.00               | 6.40                  | 20.00                  | 33.00              | 19.00      | 122.00      | 38.00      | 6        |
| 150235   | ● Brown  | 76.00               | 6.40                  | 20.00                  | 33.00              | 19.00      | 122.00      | 38.00      | 6        |
| 150252   | ● Green  | 76.00               | 6.40                  | 20.00                  | 33.00              | 19.00      | 122.00      | 38.00      | 6        |
| 150344   | ● Orange | 76.00               | 6.40                  | 20.00                  | 33.00              | 19.00      | 122.00      | 38.00      | 6        |
| 150358   | ● Purple | 76.00               | 6.40                  | 20.00                  | 33.00              | 19.00      | 122.00      | 38.00      | 6        |
| 150323   | ● Red    | 76.00               | 6.40                  | 20.00                  | 33.00              | 19.00      | 122.00      | 38.00      | 6        |
| 150297   | ● Silver | 76.00               | 6.40                  | 20.00                  | 33.00              | 19.00      | 122.00      | 38.00      | 6        |
| 150345   | ● Yellow | 76.00               | 6.40                  | 20.00                  | 33.00              | 19.00      | 122.00      | 38.00      | 6        |





## Traditional Full Aluminium Padlocks

Manufactured with solid aluminum body and shackle, our padlocks are amazingly lightweight and easy to use

- Solid anodised aluminium body
- Supplied with aluminium shackle
- Hardened steel or stainless steel shackle available on request
- Corrosion resistance
- Optional Engraving on Front, Back, Side, Bottom & Key
- Lock labels sold separately. See page 34
- Non-key retaining, key retaining upon request  
(Key won't release until padlock shackle is correctly closed)

**Padlocks are supplied keyed different.  
2 keys supplied with each lock, NOT key retaining.  
Custom keying and charting is available.**



Consult the technical datasheet LOTO-10 on [bradyeurope.com/tds](http://bradyeurope.com/tds)

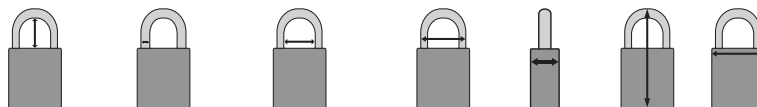

| Order Reference             | Colour   | Shackle Height (mm) | Shackle Diameter (mm) | Shackle Clearance (mm) | Shackle Width (mm) | Depth (mm) | Height (mm) | Width (mm) | Quantity |
|-----------------------------|----------|---------------------|-----------------------|------------------------|--------------------|------------|-------------|------------|----------|
| <b>Shackle Height 25 mm</b> |          |                     |                       |                        |                    |            |             |            |          |
| 814067                      | ● Black  | 25.00               | 6.50                  | 20.00                  | 31.50              | 19.00      | 73.00       | 40.00      | 6        |
| 814065                      | ● Blue   | 25.00               | 6.50                  | 20.00                  | 31.50              | 19.00      | 73.00       | 40.00      | 6        |
| 830939                      | ● Brown  | 25.00               | 6.50                  | 20.00                  | 31.50              | 19.00      | 73.00       | 40.00      | 6        |
| 814069                      | ● Green  | 25.00               | 6.50                  | 20.00                  | 31.50              | 19.00      | 73.00       | 40.00      | 6        |
| 830936                      | ● Grey   | 25.00               | 6.50                  | 20.00                  | 31.50              | 19.00      | 73.00       | 40.00      | 6        |
| 814070                      | ● Orange | 25.00               | 6.50                  | 20.00                  | 31.50              | 19.00      | 73.00       | 40.00      | 6        |
| 814071                      | ● Purple | 25.00               | 6.50                  | 20.00                  | 31.50              | 19.00      | 73.00       | 40.00      | 6        |
| 814066                      | ● Red    | 25.00               | 6.50                  | 20.00                  | 31.50              | 19.00      | 73.00       | 40.00      | 6        |
| 814068                      | ● Yellow | 25.00               | 6.50                  | 20.00                  | 31.50              | 19.00      | 73.00       | 40.00      | 6        |
| <b>Shackle Height 40 mm</b> |          |                     |                       |                        |                    |            |             |            |          |
| 814074                      | ● Black  | 40.00               | 6.50                  | 20.00                  | 31.50              | 19.00      | 89.00       | 40.00      | 6        |
| 814072                      | ● Blue   | 40.00               | 6.50                  | 20.00                  | 31.50              | 19.00      | 89.00       | 40.00      | 6        |
| 830940                      | ● Brown  | 40.00               | 6.50                  | 20.00                  | 31.50              | 19.00      | 89.00       | 40.00      | 6        |
| 814076                      | ● Green  | 40.00               | 6.50                  | 20.00                  | 31.50              | 19.00      | 89.00       | 40.00      | 6        |
| 830937                      | ● Grey   | 40.00               | 6.50                  | 20.00                  | 31.50              | 19.00      | 89.00       | 40.00      | 6        |
| 814077                      | ● Orange | 40.00               | 6.50                  | 20.00                  | 31.50              | 19.00      | 89.00       | 40.00      | 6        |
| 814078                      | ● Purple | 40.00               | 6.50                  | 20.00                  | 31.50              | 19.00      | 89.00       | 40.00      | 6        |
| 814073                      | ● Red    | 40.00               | 6.50                  | 20.00                  | 31.50              | 19.00      | 89.00       | 40.00      | 6        |
| 814075                      | ● Yellow | 40.00               | 6.50                  | 20.00                  | 31.50              | 19.00      | 89.00       | 40.00      | 6        |
| <b>Shackle Height 75 mm</b> |          |                     |                       |                        |                    |            |             |            |          |
| 814081                      | ● Black  | 75.00               | 6.50                  | 20.00                  | 31.50              | 19.00      | 119.00      | 40.00      | 6        |
| 814079                      | ● Blue   | 75.00               | 6.50                  | 20.00                  | 31.50              | 19.00      | 119.00      | 40.00      | 6        |
| 830941                      | ● Brown  | 75.00               | 6.50                  | 20.00                  | 31.50              | 19.00      | 119.00      | 40.00      | 6        |
| 814083                      | ● Green  | 75.00               | 6.50                  | 20.00                  | 31.50              | 19.00      | 119.00      | 40.00      | 6        |
| 830938                      | ● Grey   | 75.00               | 6.50                  | 20.00                  | 31.50              | 19.00      | 119.00      | 40.00      | 6        |
| 814084                      | ● Orange | 75.00               | 6.50                  | 20.00                  | 31.50              | 19.00      | 119.00      | 40.00      | 6        |
| 814085                      | ● Purple | 75.00               | 6.50                  | 20.00                  | 31.50              | 19.00      | 119.00      | 40.00      | 6        |
| 814080                      | ● Red    | 75.00               | 6.50                  | 20.00                  | 31.50              | 19.00      | 119.00      | 40.00      | 6        |
| 814082                      | ● Yellow | 75.00               | 6.50                  | 20.00                  | 31.50              | 19.00      | 119.00      | 40.00      | 6        |



Visit our YouTube™ channel for a range of available training videos.



## Traditional Aluminium Compact Padlocks

Lightweight and easy to use, ideal for small spaces

- Solid anodised aluminium body
- Supplied with aluminium shackle
- Corrosion resistance
- Engraving on Front, Back & Sides

Padlocks are supplied keyed different. 1 key supplied with each lock.

Custom keying and charting is available.



The compact aluminium padlock is perfect for small space applications and where lightweight and easy to carry locks are needed. For even more durable applications, please refer to Brady's range of padlocks with 6.50 mm diam shackles for more durability.



| Order Reference             | Colour   | Shackle Height (mm) | Shackle Diameter (mm) | Shackle Clearance (mm) | Shackle Width (mm) | Depth (mm) | Height (mm) | Width (mm) | Quantity |
|-----------------------------|----------|---------------------|-----------------------|------------------------|--------------------|------------|-------------|------------|----------|
| <b>Shackle Height 25 mm</b> |          |                     |                       |                        |                    |            |             |            |          |
| 834857                      | ● Black  | 25.00               | 4.70                  | 17.00                  | 26.00              | 19.00      | 64.00       | 32.00      | 6        |
| 834856                      | ● Blue   | 25.00               | 4.70                  | 17.00                  | 26.00              | 19.00      | 64.00       | 32.00      | 6        |
| 834860                      | ● Green  | 25.00               | 4.70                  | 17.00                  | 26.00              | 19.00      | 64.00       | 32.00      | 6        |
| 834861                      | ● Orange | 25.00               | 4.70                  | 17.00                  | 26.00              | 19.00      | 64.00       | 32.00      | 6        |
| 834858                      | ● Red    | 25.00               | 4.70                  | 17.00                  | 26.00              | 19.00      | 64.00       | 32.00      | 6        |
| 834859                      | ● Yellow | 25.00               | 4.70                  | 17.00                  | 26.00              | 19.00      | 64.00       | 32.00      | 6        |
| <b>Shackle Height 40 mm</b> |          |                     |                       |                        |                    |            |             |            |          |
| 834863                      | ● Black  | 40.00               | 4.70                  | 17.00                  | 26.00              | 19.00      | 89.00       | 32.00      | 6        |
| 834862                      | ● Blue   | 40.00               | 4.70                  | 17.00                  | 26.00              | 19.00      | 89.00       | 32.00      | 6        |
| 834866                      | ● Green  | 40.00               | 4.70                  | 17.00                  | 26.00              | 19.00      | 89.00       | 32.00      | 6        |
| 834867                      | ● Orange | 40.00               | 4.70                  | 17.00                  | 26.00              | 19.00      | 89.00       | 32.00      | 6        |
| 834864                      | ● Red    | 40.00               | 4.70                  | 17.00                  | 26.00              | 19.00      | 89.00       | 32.00      | 6        |
| 834865                      | ● Yellow | 40.00               | 4.70                  | 17.00                  | 26.00              | 19.00      | 89.00       | 32.00      | 6        |
| <b>Shackle Height 50 mm</b> |          |                     |                       |                        |                    |            |             |            |          |
| 834869                      | ● Black  | 50.00               | 4.70                  | 17.00                  | 26.00              | 19.00      | 99.00       | 32.00      | 6        |
| 834868                      | ● Blue   | 50.00               | 4.70                  | 17.00                  | 26.00              | 19.00      | 99.00       | 32.00      | 6        |
| 834872                      | ● Green  | 50.00               | 4.70                  | 17.00                  | 26.00              | 19.00      | 99.00       | 32.00      | 6        |
| 834873                      | ● Orange | 50.00               | 4.70                  | 17.00                  | 26.00              | 19.00      | 99.00       | 32.00      | 6        |
| 834870                      | ● Red    | 50.00               | 4.70                  | 17.00                  | 26.00              | 19.00      | 99.00       | 32.00      | 6        |
| 834871                      | ● Yellow | 50.00               | 4.70                  | 17.00                  | 26.00              | 19.00      | 99.00       | 32.00      | 6        |
| <b>Shackle Height 75 mm</b> |          |                     |                       |                        |                    |            |             |            |          |
| 834875                      | ● Black  | 75.00               | 4.70                  | 17.00                  | 26.00              | 19.00      | 119.00      | 32.00      | 6        |
| 834874                      | ● Blue   | 75.00               | 4.70                  | 17.00                  | 26.00              | 19.00      | 119.00      | 32.00      | 6        |
| 834878                      | ● Green  | 75.00               | 4.70                  | 17.00                  | 26.00              | 19.00      | 119.00      | 32.00      | 6        |
| 834879                      | ● Orange | 75.00               | 4.70                  | 17.00                  | 26.00              | 19.00      | 119.00      | 32.00      | 6        |
| 834876                      | ● Red    | 75.00               | 4.70                  | 17.00                  | 26.00              | 19.00      | 119.00      | 32.00      | 6        |
| 834877                      | ● Yellow | 75.00               | 4.70                  | 17.00                  | 26.00              | 19.00      | 119.00      | 32.00      | 6        |



Purple, brown and silver colours available upon request for large volumes.





**i** Consult the technical datasheet LOTO-11 on [bradyeurope.com/tds](http://bradyeurope.com/tds)

## Laminated Steel Padlocks

Reinforced laminated steel withstands severe physical abuse and hardened steel shackle is difficult to cut.

- Body plates individually coated for superior rust protection
- 5-pin cylinder offers more unique key cuts, better tamper-resistance than conventional 4-pin locks
- Coloured bumpers supplied for identification and protection
- Key retaining system (Key won't release until padlock shackle is closed)
- Optional Engraving on Bottom & Key
- Lock labels sold separately. See page 34

**Padlocks are supplied keyed different. 1 key supplied with each lock. Custom keying and charting is available.**

| Order Reference             | Colour   | Shackle Height (mm) | Shackle Diameter (mm) | Shackle Clearance (mm) | Shackle Width (mm) | Depth (mm) | Height (mm) | Width (mm) | Quantity |
|-----------------------------|----------|---------------------|-----------------------|------------------------|--------------------|------------|-------------|------------|----------|
| <b>Shackle Height 20 mm</b> |          |                     |                       |                        |                    |            |             |            |          |
| 814087                      | ● Black  | 20.00               | 7.00                  | 18.50                  | 32.50              | 23.00      | 58.00       | 44.00      | 6        |
| 814086                      | ● Blue   | 20.00               | 7.00                  | 18.50                  | 32.50              | 23.00      | 58.00       | 44.00      | 6        |
| 814092                      | ● Brown  | 20.00               | 7.00                  | 18.50                  | 32.50              | 23.00      | 58.00       | 44.00      | 6        |
| 814090                      | ● Green  | 20.00               | 7.00                  | 18.50                  | 32.50              | 23.00      | 58.00       | 44.00      | 6        |
| 814091                      | ● Orange | 20.00               | 7.00                  | 18.50                  | 32.50              | 23.00      | 58.00       | 44.00      | 6        |
| 814093                      | ● Purple | 20.00               | 7.00                  | 18.50                  | 32.50              | 23.00      | 58.00       | 44.00      | 6        |
| 814088                      | ● Red    | 20.00               | 7.00                  | 18.50                  | 32.50              | 23.00      | 58.00       | 44.00      | 6        |
| 814094                      | ○ White  | 20.00               | 7.00                  | 18.50                  | 32.50              | 23.00      | 58.00       | 44.00      | 6        |
| 814089                      | ● Yellow | 20.00               | 7.00                  | 18.50                  | 32.50              | 23.00      | 58.00       | 44.00      | 6        |
| <b>Shackle Height 38 mm</b> |          |                     |                       |                        |                    |            |             |            |          |
| 814096                      | ● Black  | 38.00               | 7.00                  | 18.50                  | 32.50              | 23.00      | 77.00       | 44.00      | 6        |
| 814095                      | ● Blue   | 38.00               | 7.00                  | 18.50                  | 32.50              | 23.00      | 77.00       | 44.00      | 6        |
| 814101                      | ● Brown  | 38.00               | 7.00                  | 18.50                  | 32.00              | 23.00      | 77.00       | 44.00      | 6        |
| 814099                      | ● Green  | 38.00               | 7.00                  | 18.50                  | 32.00              | 23.00      | 77.00       | 44.00      | 6        |
| 814100                      | ● Orange | 38.00               | 7.00                  | 18.50                  | 32.00              | 23.00      | 77.00       | 44.00      | 6        |
| 814102                      | ● Purple | 38.00               | 7.00                  | 18.50                  | 32.00              | 23.00      | 77.00       | 44.00      | 6        |
| 814097                      | ● Red    | 38.00               | 7.00                  | 18.50                  | 32.50              | 23.00      | 77.00       | 44.00      | 6        |
| 814103                      | ○ White  | 38.00               | 7.00                  | 18.50                  | 32.00              | 23.00      | 77.00       | 44.00      | 6        |
| 814098                      | ● Yellow | 38.00               | 7.00                  | 18.50                  | 32.50              | 23.00      | 77.00       | 44.00      | 6        |
| <b>Shackle Height 51 mm</b> |          |                     |                       |                        |                    |            |             |            |          |
| 814105                      | ● Black  | 51.00               | 7.00                  | 18.50                  | 32.00              | 23.00      | 90.00       | 44.00      | 6        |
| 814104                      | ● Blue   | 51.00               | 7.00                  | 18.50                  | 32.00              | 23.00      | 90.00       | 44.00      | 6        |
| 814110                      | ● Brown  | 51.00               | 7.00                  | 18.50                  | 32.00              | 23.00      | 90.00       | 44.00      | 6        |
| 814108                      | ● Green  | 51.00               | 7.00                  | 18.50                  | 32.00              | 23.00      | 90.00       | 44.00      | 6        |
| 814109                      | ● Orange | 51.00               | 7.00                  | 18.50                  | 32.00              | 23.00      | 90.00       | 44.00      | 6        |
| 814111                      | ● Purple | 51.00               | 7.00                  | 18.50                  | 32.00              | 23.00      | 90.00       | 44.00      | 6        |
| 814106                      | ● Red    | 51.00               | 7.00                  | 18.50                  | 32.00              | 23.00      | 90.00       | 44.00      | 6        |
| 814112                      | ○ White  | 51.00               | 7.00                  | 18.50                  | 32.00              | 23.00      | 90.00       | 44.00      | 6        |
| 814107                      | ● Yellow | 51.00               | 7.00                  | 18.50                  | 32.00              | 23.00      | 90.00       | 44.00      | 6        |

## Ultimate Security Padlocks

- Shackle and body made of highest standard hardened alloy steel
- Abus-Plus 7 pin disk cylinder for ultimate protection against manipulation and key interchanges
- Optional Engraving on Bottom & Key

**Padlocks are supplied keyed different. 2 keys supplied with each lock. Custom keying and charting is available.**



| Order Reference | Colour  | Shackle Height (mm) | Shackle Diameter (mm) | Shackle Clearance (mm) | Shackle Width (mm) | Depth (mm) | Height (mm) | Width (mm) | Quantity |
|-----------------|---------|---------------------|-----------------------|------------------------|--------------------|------------|-------------|------------|----------|
| 805837          | ● Black | 26.00               | 11.00                 | 27.50                  | 49.50              | 31.00      | 85.00       | 63.00      | 2        |
| 805838          | ● Black | 50.00               | 11.00                 | 27.50                  | 49.50              | 31.00      | 109.00      | 63.00      | 2        |
| 805839          | ● Black | 75.00               | 11.00                 | 27.50                  | 49.50              | 31.00      | 134.00      | 63.00      | 1        |

## Fully Insulated Padlocks

Body and shackle fully insulated against electric shock

- Solid brass body
- Sealed lock body with cylinder cover to protect cylinder from dirt
- 5-pin cylinder
- Inner components made from non-corrosive materials
- Shock absorbing vinyl casing, also protects painted surfaces
- Hardened or stainless steel shackle

Locks are supplied keyed different. 2 keys supplied with each lock.  
Keyed alike upon request



| Order Reference | Colour  | Shackle Height (mm) | Shackle Diameter (mm) | Shackle Clearance (mm) | Shackle Width (mm) | Depth (mm) | Height (mm) | Width (mm) | Quantity |
|-----------------|---------|---------------------|-----------------------|------------------------|--------------------|------------|-------------|------------|----------|
| 805835          | ● Black | 24.50               | 8.50                  | 20.50                  | 37.50              | 28.00      | 73.00       | 53.00      | 6        |
| 805836          | ● Blue  | 24.50               | 8.50                  | 20.50                  | 37.50              | 28.00      | 73.00       | 53.00      | 6        |

## Brass Padlocks with stainless steel shackle

- Solid brass body (chrome plated) with stainless steel shackle
- Corrosion resistant
- Precision pin tumbler cylinder
- Optional Engraving on Front, Back, Side, Bottom & Key

Locks are supplied keyed different. 2 keys supplied with each lock.  
Locks are not key retaining. Keyed alike upon request.

| Order Reference | Colour   | Shackle Height (mm) | Shackle Diameter (mm) | Shackle Clearance (mm) | Shackle Width (mm) | Depth (mm) | Height (mm) | Width (mm) | Quantity |
|-----------------|----------|---------------------|-----------------------|------------------------|--------------------|------------|-------------|------------|----------|
| 805827          | ● Chrome | 14.50               | 5.00                  | 14.50                  | 24.50              | 12.00      | 47.00       | 30.00      | 6        |
| 805828          | ● Chrome | 23.50               | 6.50                  | 19.50                  | 32.50              | 13.00      | 66.00       | 39.00      | 6        |
| 805830          | ● Chrome | 27.00               | 7.00                  | 28.00                  | 42.00              | 15.00      | 73.00       | 49.00      | 6        |



## Brass Padlocks with hardened steel shackle

- All inner components are non-corrosive
- Brass body and hardened steel shackle
- Precision pin tumbler cylinder
- Optional Engraving on Front, Back, Side, Bottom & Key

Locks are supplied keyed different. 2 keys supplied with each lock.

| Order Reference | Colour  | Shackle Height (mm) | Shackle Diameter (mm) | Shackle Clearance (mm) | Shackle Width (mm) | Depth (mm) | Height (mm) | Width (mm) | Quantity |
|-----------------|---------|---------------------|-----------------------|------------------------|--------------------|------------|-------------|------------|----------|
| 805831          | ● Brass | 14.50               | 5.00                  | 14.50                  | 24.50              | 12.00      | 47.00       | 30.00      | 6        |
| 805832          | ● Brass | 23.50               | 6.50                  | 19.50                  | 32.50              | 13.00      | 66.00       | 39.00      | 6        |
| 805834          | ● Brass | 27.00               | 7.00                  | 28.00                  | 42.00              | 15.00      | 73.00       | 49.00      | 6        |



## Combination padlock

- Compact, lightweight lock
- Hardened steel shackle
- 4-digit resettable code

| Order Reference | Colour   | Shackle Height (mm) | Shackle Diameter (mm) | Shackle Width (mm) | Depth (mm) | Height (mm) | Width (mm) | Quantity |
|-----------------|----------|---------------------|-----------------------|--------------------|------------|-------------|------------|----------|
| 101963          | ● Silver | 26.00               | 6.50                  | 19.50              | 18.50      | 80.00       | 44.50      | 1        |





## Safety lock & tag carrier

The Safety Lock & Tag Carrier is designed to hold up to 12 safety padlocks and keys, as well as lockout hasps and procedure tags.

- holds up to 12 padlocks
- includes a key strap and carabiners
- can easily be clipped back to back to carry 24 padlocks
- can easily be attached on a belt
- can easily be mounted on a wall
- available in 4 colours

| Order Reference | Description  | Width (mm) | Height (mm) | Quantity  |
|-----------------|--|------------|-------------|-----------|
| 148866          | Safety Lock & Tag Carrier System - Red                                   | 190.50     | 133.35      | 1 Kit     |
| 148865          | Safety Lock & Tag Carrier System - Yellow                                | 190.50     | 133.35      | 1 Kit     |
| 148861          | Safety Lock & Tag Carrier System - Green                                 | 190.50     | 133.35      | 1 Kit     |
| 148862          | Safety Lock & Tag Carrier System - Blue                                  | 190.50     | 133.35      | 1 Kit     |
| 148864          | Safety Lock and Tag Carrier With 2 Sets of 6 Keyed Alike Safety Padlocks | 190.50     | 133.35      | 1 Kit     |
| 148869          | Safety Lock and Tag Carrier With 4 Sets of 3 Keyed Alike Safety Padlocks | 190.50     | 133.35      | 1 Kit     |
| 148867          | Safety Lock and Tag Carrier With 12 Keyed Different Safety Padlocks      | 190.50     | 133.35      | 1 Kit     |
| 148863          | Write-On Lockout Procedure Tag   | 76.20      | 146.05      | 10 / Pack |



## Labels for Traditional Nylon padlocks

- Made of durable vinyl, writable using pencil, pen or marker

| Order Reference | Text/Legend   | Reverse Legend                          | Material | Brady Material No. | Quantity |
|-----------------|---|---|----------|--------------------|----------|
| 051379          | DANGER LOCKED OUT, PELIGRO EQUIPO BLOQUEADO, DANGER VERROUILLÉE | PROPERTY OF, PROPIEDAD DE, PROPRIETE DE | Vinyl    | B-826              | 6        |

## Labels for SafeKey Nylon padlocks

- Made of durable vinyl, writable using pencil, pen or marker

| Order Reference | Text/Legend  | Reverse Legend                         | Material | Brady Material No. | Quantity |
|-----------------|--|--|----------|--------------------|----------|
| 150555          | LOCKED OUT DO NOT REMOVE; VERROUILLÉ NE PAS ENLEVER; EQUIPO BLOQUEADO NO REMUEVA | PROPERTY OF; PROPIÉTÉ DE; PROPIEDAD DE | Vinyl    | B-826              | 6        |
| 150556          | LOCKED OUT DO NOT REMOVE; VERROUILLÉ NE PAS ENLEVER; EQUIPO BLOQUEADO NO REMUEVA | PROPERTY OF; PROPIÉTÉ DE; PROPIEDAD DE | Vinyl    | B-826              | 6        |



## Labels for aluminium padlocks

- Made of durable vinyl, writable using pencil, pen or marker

| Order Reference | Text/Legend       | Reverse Legend | Material | Brady Material No. | Height (mm) | Width (mm) | Quantity |
|-----------------|-------------------|----------------|----------|--------------------|-------------|------------|----------|
| 050289          | DANGER LOCKED OUT | PROPERTY OF    | Vinyl    | B-826              | 20.32       | 27.94      | 6        |
| 050292          | BLOQUEADO         | PROPIEDAD DE   | Vinyl    | B-826              | 20.32       | 27.94      | 6        |
| 050293          | VERROUILLÉE       | PROPRIETE DE   | Vinyl    | B-826              | 20.32       | 27.94      | 6        |



## Labels for steel padlocks

- Made of durable vinyl, writable using pencil, pen or marker
- Supplied with B-674 overlaminates strips for enhanced durability

| Order Reference | Text/Legend              | Reverse Legend | Material | Brady Material No. | Height (mm) | Width (mm) | Quantity |
|-----------------|--------------------------|----------------|----------|--------------------|-------------|------------|----------|
| 050280          | DANGER LOCKED OUT        | PROPERTY OF    | Vinyl    | B-826              | 19.05       | 114.30     | 6        |
| 050281          | PELIGRO EQUIPO BLOQUEADO | PROPIEDAD DE   | Vinyl    | B-826              | 19.05       | 114.30     | 6        |
| 050283          | DANGER VERROUILLÉE       | PROPRIETE DE   | Vinyl    | B-826              | 19.05       | 114.30     | 6        |



## Padlock tags

- Made of calendered vinyl material that accepts pencil, pen, or marker
- 9.53 mm metal grommet that fits over most padlock shackles
- The grommet area adds another 25.40 mm to the height of the tag giving an overall size of 50.80 x 101.60 mm.

| Order Reference | Text/Legend                               | Material         | Height (mm) | Width (mm) | Quantity |
|-----------------|---|------------------|-------------|------------|----------|
| 105722          | DANGER EQUIPMENT LOCKED OUT               | Calendered Vinyl | 50.80       | 76.20      | 1        |
| 105723          | DANGER DO NOT OPERATE                     | Calendered Vinyl | 50.80       | 76.20      | 1        |
| 105724          | DANGER DO NOT OPERATE / PELIGRO NO ACTIVE | Calendered Vinyl | 50.80       | 76.20      | 1        |



## Padlock lubricant

- Non-greasing spray for lock cylinders, office machines, tools, car locks, etc.

| Order Reference | Description            | Quantity |
|-----------------|------------------------|----------|
| 834194          | Maintenance spray 50ml | 1        |



## “Cobra” cable

- Flexible steel wire with protective PVC coating

| Order Reference | Description  | Diameter (mm) | Length (m) | Quantity |
|-----------------|--------------|---------------|------------|----------|
| 805844          | “Cobra Cable | 8.00          | 2 m        | 1        |



## Maximum chain security

- Chain made from hardened special chain steel
- Fabric sleeve protects paint work and chrome from damage

| Order Reference | Description                         | Length (m) | Quantity |
|-----------------|-------------------------------------|------------|----------|
| 805846          | Maximum Chain Security - 10 mm diam | 1.1 m      | 2        |
| 805845          | Maximum Chain Security - 8 mm diam  | 1.1 m      | 2        |



## Double loop cable

Double looped cable lockout devices are perfect in any situation that requires a flexible lockout device and a visual deterrent.

- Ideal for locking out large valves in many different industries
- Lightweight alternative to large, heavy chains
- Comes in four lengths to ensure a secure fit

| Order Reference | Cable Length (m) | Diameter (mm) | Material                   | Colour | Quantity |
|-----------------|------------------|---------------|----------------------------|--------|----------|
| 131063          | 0.61             | 4.76          | Plastic Coated Steel Cable | Red    | 1        |
| 131064          | 1.22             | 4.76          | Plastic Coated Steel Cable | Red    | 1        |
| 131065          | 1.83             | 4.76          | Plastic Coated Steel Cable | Red    | 1        |
| 131066          | 2.44             | 4.76          | Plastic Coated Steel Cable | Red    | 1        |



# Brady - your complete work safety solution provider

Find out more about safety products from our extensive portfolio. Visit our websites or contact your nearest Brady representative.



## Visual Tagging Solutions

Provide essential records of the safe condition of all your site equipment and scaffolding.

- Simple to implement
- Easy for workers to understand
- Specially designed for rough environments
- Highly visible



## Safety Signs - Important information at the point of need

We offer more than 8,000 different signs for safety, maintenance and facility identification.

- Designed to withstand even the harshest industrial environments
- Bright colours, bold text and intuitive pictograms
- Compliant with the latest standards and regulations
- Highly visible and easy to understand communication



## Pipe Markers - Easily identify pipe content and flow direction

The correct identification of pipes ensures a better insight into a building's structure. Accidents, injuries and damage can be prevented.



## Sorbents - Smart spill control

Clean, fast and safe removal of oil, water and chemicals spills.

- Adsorbs 10-25 times its own weight within a few seconds
- Environmentally friendly
- Spend less time cleaning



## Lock boxes and padlock centres

Brady offers a range of group lock boxes which are ideal when multiple authorised employees are involved with the equipment servicing. There are also several solutions available for efficient padlock storage.

- 38 SAFETY REDBOX™ group lockout box
- 38 Group lock box
- 38 Combined lock storage/group lockout box
- 39 Ultra compact lock box
- 39 Wall-mounted group lockout box
- 39 Wall-mounted metal group lockout box
- 39 Portable/wall group lockout box
- 40 SlimView group lock box
- 40 Group lockout centre
- 40 Enclosed padlock storage modules
- 40 Padlock control centre
- 41 Combined lockout & lock box station
- 41 Portable padlock station
- 41 Padlock stations





## SAFETY REDBOX™ group lockout box

Wall-mountable group lock box with quick-release system for great portability.

- Comes complete with convenient wall mounting bracket:
  - For storage, display and lockout event readiness
  - Quick release feature lets you carry SAFETY REDBOX™ to the point of need
  - SAFETY REDBOX™ can also be locked in place during lockout events
  - Cover is hinged lengthwise on the box for convenient opening and access even when wall-mounted
- Devices needed for specific equipment lockout needs can be stored directly in the box
- Convenient push button latching mechanism to keep the cover shut
- Internal slide button to secure the SAFETY REDBOX to the wall bracket
- Accepts up to 12 workers safety padlocks. Stays locked until all are removed
- Can hold up to 40 padlocks if not attached to the wall
- Made of heavy duty steel, powder-coated for extra rust resistance
- Designed to withstand a wide range of environmental conditions



| Order Reference | Material            | Colour | Height (mm) | Width (mm) | Depth (mm) | Max number of padlocks applied | Max. Number of Padlocks Stored | Quantity |
|-----------------|---------------------|--------|-------------|------------|------------|--------------------------------|--------------------------------|----------|
| 145579          | Powder-coated Steel | Red    | 155.00      | 236.00     | 92.00      | 12                             | 12                             | 1        |
| 145580          | Powder-coated Steel | Yellow | 155.00      | 236.00     | 92.00      | 12                             | 12                             | 1        |



Consult the technical datasheet LOTO-76 on [bradyeurope.com/tds](http://bradyeurope.com/tds)



**SAFEKEY**  
LOCKOUT PADLOCKS

## Group lock box

For group lockout situations involving a large number of workers and equipment.

- After machine or process is locked out, the key or keys of the machine are placed in a lock box. Each authorised work team member places a personal lock or tagout device in the group lock box.
- Ensures that no single employee has access to the box unless ALL employees have removed their locks or tags

| Order Reference | Description                   | Colour          | Height (mm) | Width (mm) | Depth (mm) | Max number of padlocks applied | Max. Number of Padlocks Stored | Quantity |
|-----------------|-------------------------------|-----------------|-------------|------------|------------|--------------------------------|--------------------------------|----------|
| 830929          | Extra Large Metal Lockbox     | Red             | 152.40      | 187.32     | 235.00     | 13                             | 75                             | 1        |
| 045190          | Portable Metal Group Lock Box | Blue            | 152.40      | 227.00     | 88.90      | 13                             | 40                             | 1        |
| 065672          | Portable Metal Group Lock Box | Black on Yellow | 149.86      | 227.00     | 231.14     | 1                              | 40                             | 1        |
| 065699          | Portable Metal Group Lock Box | Red             | 152.40      | 227.00     | 88.90      | 13                             | 40                             | 1        |



Consult the technical datasheet LOTO-18 on [bradyeurope.com/tds](http://bradyeurope.com/tds)



**SAFEKEY**  
LOCKOUT PADLOCKS

Lock boxes SafeKey compatible



## Combined lock storage/group lockout box

Handy box features a lockable storage compartment and a group lockout compartment.

- Made of heavy duty steel, powder-coated for extra rust resistance
- Group lockout compartment has clear Lexan window with keyhole slot
- Small size: Storage compartment holds approx. 50 padlocks. 17 padlocks holes in group lock box lid.
- Large size: Storage compartment holds approx. 125 padlocks. 34 padlocks holes in group lock box lid.

| Order Reference | Description          | Colour | Height (mm) | Width (mm) | Depth (mm) | Quantity |
|-----------------|----------------------|--------|-------------|------------|------------|----------|
| 105716          | Small metal lock box | Red    | 162.00      | 300.00     | 67.70      | 1        |
| 105717          | Large metal lock box | Red    | 229.00      | 381.00     | 229.00     | 1        |



Consult the technical datasheet LOTO-19 on [bradyeurope.com/tds](http://bradyeurope.com/tds)

## Ultra compact lock box

- Easy portability and toolbox/bag fit with durable, compact design
- Simple storage with wall-mount bracket and releasing push lock (reverse push lock for added security)
- Effective group lockout with 12 lock slots
- Efficient energy isolation with space to carry 6 padlocks inside
- Box content visibility with hinged, transparent cover
- Convenient key storage with 3 hanging hooks



**SAFEKEY**  
LOCKOUT PADLOCKS



| Order Reference | Description                                | Colour | Height (mm) | Width (mm) | Depth (mm) | Quantity |
|-----------------|--|--------|-------------|------------|------------|----------|
| 149173          | Ultra-Compact Group Lock Box               | Red    | 144.78      | 101.60     | 68.58      | 1        |
| 149174          | Ultra-Compact Lock Box + 6 Red KA Locks    | Red    | 144.78      | 101.60     | 68.58      | 1        |
| 149175          | Ultra-Compact Lock Box + 6 Red KD Locks    | Red    | 144.78      | 101.60     | 68.58      | 1        |
| 149172          | Ultra-Compact Lock Box + 6 Yellow KA Locks | Red    | 144.78      | 101.60     | 68.58      | 1        |
| 149176          | Ultra-Compact Lock Box + 6 Yellow KD Locks | Red    | 144.78      | 101.60     | 68.58      | 1        |

## Wall-mounted group lockout box

- Injection moulded using Isoplast polymers for rugged durability
- Excellent chemical and heat resistance and impossible to corrode
- Slot in front allows keys to be inserted when box is locked
- Transparent polycarbonate windows let you view content
- Pre-drilled holes in back allow for easy wall-mounting
- Lock rails hold up to 8 padlocks (locks not included)\*
- Box comes with 6 hooks for hanging keys, locks, etc, inside box

| Order Reference | Description      | Colour | Height (mm) | Width (mm) | Depth (mm) | Quantity |
|-----------------|------------------|--------|-------------|------------|------------|----------|
| 050938          | Plastic Lock Box | Red    | 157.48      | 101.60     | 139.70     | 1        |
| 050939          | Extra Hooks      | Black  | -           | -          | -          | 12       |

\* If using cable padlocks, the cable will need to fit through two holes to secure. Therefore only 4 padlocks can be applied.



**SAFEKEY**  
LOCKOUT PADLOCKS

## Wall-mounted metal group lockout box

- Made of durable, powder-coated steel with key slot on top
- Includes clear Lexan window that slides out when locks are removed
- Comes with key pegs and ID labels to simplify key management
- Pre-drilled holes and hardware included for quick mounting

| Order Reference | Description               | Height (mm) | Width (mm) | Depth (mm) | Max number of padlocks applied | Quantity |
|-----------------|---------------------------|-------------|------------|------------|--------------------------------|----------|
| 105714          | Small metal wall lock box | 178.00      | 203.00     | 57.15      | 7                              | 1        |
| 105715          | Large metal wall lock box | 178.00      | 406.00     | 57.15      | 12                             | 1        |



**SAFEKEY**  
LOCKOUT PADLOCKS



**SAFEKEY**  
LOCKOUT PADLOCKS

Lock boxes SafeKey compatible

## Portable/wall group lockout box

- Made of yellow powder-coated metal
- Can be used alone or in combination with Industrial Strength Lockout Station
- Accommodates 8-10 locks (depending on lock size)

| Order Reference | Description                                | Material         | Colour | Height (mm) | Width (mm) | Depth (mm) | Quantity |
|-----------------|--|------------------|--------|-------------|------------|------------|----------|
| 046134          | PRINZING Portable / Wall Group Lockout Box | Mild Sheet Steel | Yellow | 151.00      | 354.50     | 73.40      | 1        |

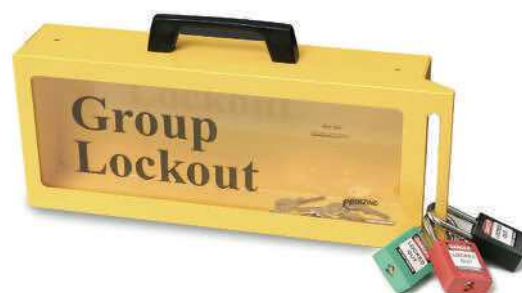

Consult the technical datasheet LOTO-21 on [bradyeurope.com/tds](http://bradyeurope.com/tds)





## SlimView group lock box

- Efficient and easy to use thanks to a slim design with pre-cut mounting holes and transparent door
- Easily carry up to 12 padlocks with built-in padlock & key hangers
- Safe key deposit that can be locked with up to 12 padlocks
- Padlocks sold separately

| Order Reference | Description             | Material                                  | Colour            | Height (mm) | Width (mm) | Depth (mm) | Quantity |
|-----------------|-------------------------|---|-------------------|-------------|------------|------------|----------|
| 150505          | SlimView Group Lock Box | Heavy Duty Steel with Polycarbonate Cover | Red & Transparent | 153.80      | 266.83     | 79.06      | 1        |



**SAFEKEY**  
LOCKOUT PADLOCKS

Lock boxes SafeKey compatible



## Group lockout centre

- Apply a padlock to the key box to lock out multiple sources of energy controlled by the padlock keys inside the box
- Not designed to prevent forced entry

| Order Reference | Description                     | Material | Colour | Height (mm) | Width (mm) | Depth (mm) | Quantity |
|-----------------|---------------------------------|----------|--------|-------------|------------|------------|----------|
| 800117          | Group Lockout Centre - 3 hooks  | Acrylic  | Red    | 150.00      | 150.00     | 80.00      | 1        |
| 800116          | Group Lockout Centre - 8 hooks  | Acrylic  | Red    | 195.00      | 305.00     | 64.00      | 1        |
| 800127          | Group Lockout Centre - 18 hooks | Acrylic  | Red    | 195.00      | 406.00     | 64.00      | 1        |



## Enclosed padlock storage modules

Provides safe storage and controls access to padlocks.

- Constructed of plastic with lockable, transparent acrylic doors
- Each metal hook can hold 2 locks
- Two sizes available for holding 16 or 40 padlocks
- Padlocks sold separately

| Order Reference | Description                      | Colour | Height (mm) | Width (mm) | Depth (mm) | Quantity |
|-----------------|----------------------------------|--------|-------------|------------|------------|----------|
| 065240          | Enclosed Padlock Storage Modules | White  | 381.00      | 381.00     | 88.90      | 1        |
| 065241          | Enclosed Padlock Storage Modules | White  | 762.00      | 381.00     | 88.90      | 1        |



## Padlock control centre

- Each nickel coated metal hook is large enough to hold two locks (not included)
- Two keys provided for cabinet lock

| Order Reference | Description                       | Material            | Colour | Height (mm) | Width (mm) | Depth (mm) | Quantity |
|-----------------|-----------------------------------|---------------------|--------|-------------|------------|------------|----------|
| 800118          | Padlock Control Centre - 18 hooks | Powder-coated Steel | Red    | 394.00      | 457.00     | 50.00      | 1        |
| 800119          | Padlock Control Centre - 8 hooks  | Powder-coated Steel | Red    | 254.00      | 305.00     | 50.00      | 1        |

## Combined lockout & lock box station

- Powder-coated metal yellow cabinet
- Lockout safety tips printed on inside of door
- Lock box attaches to bottom of cabinet, accommodates 8-10 locks (depending on size)
- Comes with one adjustable shelf (extra shelves available)
- Lockout cabinet is capable of being locked closed and can easily be wall mounted using pre-drilled holes in back
- Cabinet dimensions: (H) 406 x (W) 355 x (D) 152 mm
- Lock box dimensions: (H) 152 x (W) 381 x (D) 76 mm



**i** Empty lockout station also supplied separately See page 74

| Order Reference | Description                                       | Material            | Colour | Height (mm) | Width (mm) | Depth (mm) | Quantity |
|-----------------|---|---------------------|--------|-------------|------------|------------|----------|
| 099708          | Combined Lockout & Lock Box Station w/ Components | Powder-coated Metal | Yellow | 558.80      | 355.60     | 152.40     | 1        |

Components include: 1 - 120V Snap-on Breaker Lockout, 1 - 120/277 V Clamp-on Breaker Lockout, 1 - 480-600 V Clamp-on Breaker Lockout, 1 - Universal Multi-pole Breaker Lockout, 1 - Oversized Breaker Lockout, 1 - Cleat for 120/277 V Clamp-on Lockout, 1 - Cleat for 480/600 V Clamp-on Lockout, 1 - Wall Switch Lockout, 1 - 110 V Plug Lockout, 1 - 3-in-1 Plug Lockout, 1 - 25 - 64 Gate Valve Lockout and 1 - 25.40 - 165.10 Adjustable Gate Valve Lockout

## Portable padlock station

- Holds up to 10 padlocks, 6 lockout hasps and 10 tags
- Made from polypropylene: light and rustproof
- Pre-drilled holes: easy to mount on wall
- Station is supplied without contents

| Order Reference | Description              | Material      | Colour | Height (mm) | Width (mm) | Depth (mm) | Quantity |
|-----------------|--------------------------|---------------|--------|-------------|------------|------------|----------|
| 811218          | Portable Padlock Station | Polypropylene | Yellow | 432.00      | 337.00     | 64.00      | 1        |



## Padlock stations

- Steel padlock holder with red plastic coating
- Small holder allows up to 4 padlocks while large holder allows up to 24 padlocks

| Order Reference | Description           | Material                            | Colour | Height (mm) | Width (mm) | Depth (mm) | Quantity |
|-----------------|-----------------------|-------------------------------------|--------|-------------|------------|------------|----------|
| 800121          | Large Padlock Station | 14 gauge steel with plastic coating | Red    | 76.00       | 406.00     | 31.00      | 1        |
| 800120          | Small Padlock Station | 14 gauge steel with plastic coating | Red    | 57.00       | 76.00      | 31.00      | 1        |





## Lockout kits

Brady offers a range of well-equipped lockout tagout kits. The kits are designed to help workers to establish an effective and safe lockout programme and to help them comply with company lockout procedures and health and safety regulations. The range consists of several different Lockout Tagout kits, where each kit has been designed with a different need in mind.

**See our lockout tagout kits from page 67 onwards or contact us to create your customised kits.**



**Remember - an effective lockout procedure saves time, saves money and saves lives!**



# Lockout devices

Brady offers a comprehensive line of Lockout devices for both electrical and mechanical risk lockout.

## Cable lockout devices

- 44 SAFELEX™ universal cable lockout device
- 44 All purpose cable lockout
- 45 Original cable lockout
- 45 Mini cable lockout
- 45 Universal valve lockout
- 46 PRO-LOCK II cable lockout device
- 46 Scissor-Lok lockout device
- 46 Brady cable lockout device
- 46 Double loop cable

## 47 Universal valve lockout

### Ball valve lockouts

- 48 Perma-mount™ ball valve lockout
- 48 Ball valve lockout
- 48 Brady ball valve lockout
- 48 Non-conductive ball valve lockout

### Gate valve lockouts

- 49 Standard gate valve lockout
- 50 Collapsible gate valve lockouts
- 50 Adjustable gate valve lockout

### Butterfly valve lockouts

- 51 Brady butterfly valve lockout
- 51 Universal valve lockout
- 51 Butterfly valve lockout
- 51 Pull handle butterfly valve lockout

### Pipe blind lockout

- 52 Pipe blind lockout
- 52 Plug valve/drinking fountain lockout

### Gas and airline lockouts

- 53 Plug valve lockout
- 53 Cylinder tank lockout
- 53 Gas cylinder lockout
- 53 SMC airline regulator
- 53 Pneumatic quick-disconnect lockout

### Electrical risk

- 54 Miniature circuit breaker lockout
- 54 EZ Panel Loc™ system
- 55 TAGLOCK™ circuit breaker securing devices
- 56 480-600V breaker lockout
- 56 Universal multi-pole breaker lockout
- 56 Economy multi-pole breaker lockout
- 56 Single pole circuit breaker lockout
- 57 "No-hole" circuit breaker lockout
- 57 Oversized breaker lockout device
- 57 Fuse lockout
- 58 Fuse lockout - insulation plugs
- 58 3-in-1 electrical plug lockout
- 58 Lockout devices for plug connections
- 58 Stopower™ plug lockouts
- 59 Hubbell plugout for industrial plug connections
- 59 Large electrical/pneumatic lockout
- 59 Lockout bag
- 60 Twist and Secure™ push button & e-stop covers
- 60 Push button lockouts
- 61 Wall switch lockouts
- 61 Fuse blockout devices
- 61 AC sensors
- 61 BatteryBlock power connector lockout
- 62 Confined space safety covers



**i** Consult the technical datasheet LOTO-75 on [bradyeurope.com/tds](http://bradyeurope.com/tds)

## SAFELEX™ universal cable lockout device

Secure multiple energy disconnects with versatile group lockout hasp.

- Safety hasp-shaped body clearly identifies the equipment lockout application
- Lightweight for easy handling, carrying, operation and storage
- Versatile to lock out multiple electrical or valve energy isolation points
- Effectively lock out diverse shutoff configurations
- Complete the lockout by securing 1 to 6 safety padlocks to the locking body
- Cable can be tightened to remove slack even when locked
- Designed to withstand a wide range of environmental conditions

| Order Reference | Description   | Cable Length (m) | Cable Diameter (mm) | Cable Material       | Colour      | Max. Shackle Diameter (mm) | Quantity |
|-----------------|---|------------------|---------------------|----------------------|-------------|----------------------------|----------|
| 145554          | SafeLex Universal Cable Lockout Device - 1 m Sheathed Steel Cable | 1.00             | 4.10                | Sheathed steel cable | Red & Black | 9.53                       | 1        |
| 145550          | SafeLex Universal Cable Lockout Device - 2 m Nylon Cable          | 2.00             | 4.10                | Nylon                | Red & Black | 9.53                       | 1        |
| 145553          | SafeLex Universal Cable Lockout Device - 2 m Sheathed Steel Cable | 2.00             | 4.10                | Sheathed steel cable | Red & Black | 9.53                       | 1        |
| 145549          | SafeLex Universal Cable Lockout Device - 3 m Nylon Cable          | 3.00             | 4.10                | Nylon                | Red & Black | 9.53                       | 1        |
| 145552          | SafeLex Universal Cable Lockout Device - 3 m Sheathed Steel Cable | 3.00             | 4.10                | Sheathed steel cable | Red & Black | 9.53                       | 1        |
| 145551          | SafeLex Universal Cable Lockout Device - 5 m Sheathed Steel Cable | 5.00             | 4.10                | Sheathed steel cable | Red & Black | 9.53                       | 1        |



## All purpose cable lockout

The ergonomic, hand-fitted body makes it easy to tighten the cable.

Can be used to lock out valves, disconnect switches, circuit breakers and more.

- Locks out multiple control points with a single device = reduced equipment costs
- Interchangeable cables, select the best type suited for the job
- High portability, a built-in eyelet helps keep the cable neatly coiled, prevents loose ends from dangling and causing a hazard when in use
- Body withstands chemicals and corrosion
- 4 Padlocks can be applied

**i** Consult the technical datasheet LOTO-3 on [bradyeurope.com/tds](http://bradyeurope.com/tds)



| Order Reference | Description   | Material  | Cable Length (m) | Cable Diameter (mm) | Colour | Max. Shackle Diameter (mm) | Min. Shackle Clearance (mm) | Quantity |
|-----------------|---|---|------------------|---------------------|--------|----------------------------|-----------------------------|----------|
| 050941*         | All Purpose Cable Lockout with Non-Conductive Nylon Cable | Glass-filled Polyurethane Polymer & Glass-filled Nylon & Non-Conductive Nylon | 2.44             | 4.33                | Red    | 7.00                       | 20.00                       | 1        |
| 050943          | All Purpose Cable Lockout with Vinyl Coated Metal Cable   | Glass-filled Polyurethane Polymer & Glass-filled Nylon & Vinyl Coated Metal   | 2.44             | 4.76                | Red    | 7.00                       | 20.00                       | 1        |
| 050944          | All Purpose Cable Lockout without cable                   | Glass-filled Polyurethane Polymer & Glass-filled Nylon                        | -                | -                   | Red    | 7.00                       | 20.00                       | 1        |

\*This product meets the ATEX Equipment Directive.

### Additional Cables

| Order Reference | Description                         | Cable Length (m) | Colour | Diameter (mm) | Quantity |
|-----------------|-------------------------------------|------------------|--------|---------------|----------|
| 050945          | Non-Conductive Nylon Cable - 2.44 m | 2.44             | Red    | 4.33          | 1        |
| 050947          | Vinyl Coated Metal Cable - 2.44 m   | 2.44             | Red    | 4.76          | 1        |
| 813642          | Vinyl Coated Metal Cable - 3.00 m   | 3.00             | Red    | 4.00          | 1        |
| 050948          | Non-Conductive Nylon Cable - 3.65 m | 3.65             | Red    | 3.18          | 1        |
| 050950          | Vinyl Coated Metal Cable - 3.65 m   | 3.65             | Red    | 4.76          | 1        |
| 050951          | Non-Conductive Nylon Cable - 4.10 m | 4.10             | Red    | 4.33          | 1        |
| 050954          | Non-Conductive Nylon Cable - 5.10 m | 5.10             | Red    | 4.33          | 1        |



## Original cable lockout

Brady's original, patented cable lockout device is perfect for your difficult lockout situations such as large gate valves or oversized devices.

- Simply squeeze device to tighten cable, insert your padlock to secure the handle and you're done!
- Body is made of impact modified nylon
- Available in several colours
- Comes with galvanised steel cable (non-coated)

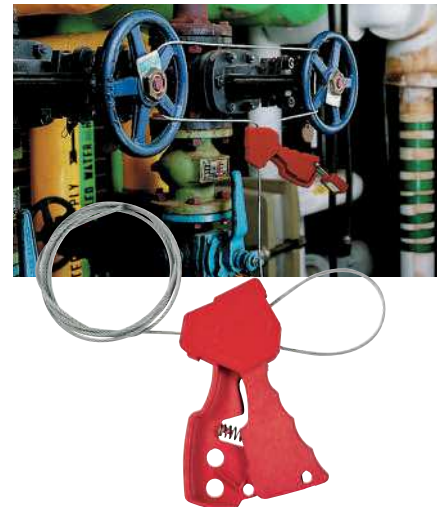



| Order Reference | Description            | Colour | Height (mm) | Width (mm) | Cable Length (m) | Cable Diameter (mm) | Quantity |
|-----------------|------------------------|--------|-------------|------------|------------------|---------------------|----------|
| 045191          | Original Cable Lockout | Blue   | 182.70      | 72.00      | 1.80             | 3.20                | 1        |
| 045192          | Original Cable Lockout | Yellow | 182.70      | 72.00      | 1.80             | 3.20                | 1        |
| 065318          | Original Cable Lockout | Red    | 182.70      | 72.00      | 1.80             | 3.20                | 1        |
| 065319          | Additional Cable       | Silver | -           | -          | 1.80             | 3.20                | 1        |
| 065320          | Additional Cable       | Silver | -           | -          | 3.00             | 3.20                | 1        |

## Mini cable lockout

Fits in the palm of your hand and is easily stowed away in your toolbox! One device for both electrical and mechanical lockout applications saves time and money.

- Locks out valves as well as disconnected switches and circuit breakers
- Cable stored internally: works just like a tape measure, prevents cable from getting tangled
- Push-button self-winding mechanism automatically holds cable tight
- Comes with vinyl-coated steel cable or non-conductive nylon cable
- The sheathed metal cable provides extra strength for getting a tight fit on valves and levers
- Superior chemical, corrosion and temperature resistance
- 6 Padlocks can be applied

  Consult the technical datasheet LOTO-38 on [bradyeurope.com/tds](http://bradyeurope.com/tds)

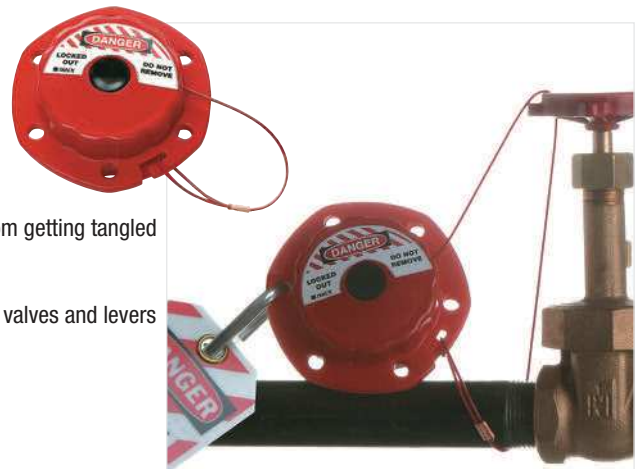

| Order Reference | Description                         | Cable Length (m) | Diameter (mm) | Depth (mm) | Max. Shackle Diameter (mm) | Min. Shackle Clearance (mm) | Cable Diameter (mm) | Quantity |
|-----------------|-------------------------------------|------------------|---------------|------------|----------------------------|-----------------------------|---------------------|----------|
| 050940          | Mini Cable Lockout with steel cable | 2.44             | 100.00        | 45.00      | 7.00                       | 20.00                       | 1.60                | 1        |
| 051442*         | Mini Cable Lockout with nylon cable | 2.44             | 100.00        | 45.00      | 7.00                       | 20.00                       | 1.60                | 1        |

\*This product meets the ATEX Equipment Directive.

## Universal valve lockout

Lockout gate valves using the cable attachment with the universal valve lockout.

- Locks out valves in open and closed positions
- Flexible modular system
- Made from industrial-grade steel and nylon for rugged durability, chemical and corrosion resistance
- Open-ended clamp fits over closed rings, wide handles

  Consult the technical datasheet LOTO-24 on [bradyeurope.com/tds](http://bradyeurope.com/tds)



| Order Reference | Description   | Colour | Max. Handle Thickness (mm) | Max. Valve Handle Width (mm) | Max. Shackle Diameter (mm) | Min. Shackle Clearance (mm) | Quantity |
|-----------------|---|--------|----------------------------|------------------------------|----------------------------|-----------------------------|----------|
| 050899          | Large Universal Valve Lockout Base Clamping Unit                        | Red    | 27.94                      | 40.64                        | 9.00                       | 20.00                       | 1        |
| 050924          | Small Universal Valve Lockout Base Clamping Unit                        | Red    | 15.24                      | 25.40                        | 9.00                       | 20.00                       | 1        |
| 051395          | Cable attachment with 2.44 metre sheathed cable. Cable diameter 3.25 mm | Red    | -                          | -                            | -                          | -                           | 1        |



## PRO-LOCK II cable lockout device

This is a complete isolation safety system, ideal for securing valves or industrial machinery and can only be opened and locked by using a special operating tool (to be ordered separately).

- Polypropylene Moulding & Stainless Steel
- UV Stabilised
- Temperature resistance range: -50 °C to 55 °C
- Vinyl coated cable

Other cable lengths are available upon request.



| Order Reference | Description                | Colour | Cable Length (m) | Cable Diameter (mm) | Max. Shackle Diameter (mm) | Min. Shackle Clearance (mm) | Diameter (mm) | Quantity |
|-----------------|----------------------------|--------|------------------|---------------------|----------------------------|-----------------------------|---------------|----------|
| 225203          | Pro-Lock device with cable | Red    | 1.50             | 3.50                | 6.50                       | 20.00                       | 50.00         | 1        |
| 225204          | Pro-Lock device with cable | Green  | 1.50             | 3.50                | 6.50                       | 20.00                       | 50.00         | 1        |
| 225205          | Pro-Lock device with cable | Yellow | 1.50             | 3.50                | 6.50                       | 20.00                       | 50.00         | 1        |
| 225206          | Operating tool             | Red    | -                | -                   | -                          | -                           | -             | 1        |
| 225207          | Operating tool             | Green  | -                | -                   | -                          | -                           | -             | 1        |
| 225208          | Operating tool             | Yellow | -                | -                   | -                          | -                           | -             | 1        |



## Scissor-Lok lockout device

Locks out multiple gate valves simultaneously. Secures power cords, freestanding equipment, tanks, cylinders or safety guards.

- Made of heavy-duty chemical resistant nylon
- Available with vinyl coated cable
- 3 padlocks can be applied. When using own cable, the outside diameter must be 4.76 mm or less

The cable and device can be combined in several ways (see examples).



| Order Reference | Description                   | Cable Length (m) | Colour | Max. Shackle Diameter (mm) | Min. Shackle Clearance (mm) | Quantity |
|-----------------|-------------------------------|------------------|--------|----------------------------|-----------------------------|----------|
| 236921          | Scissor Lok Device with Cable | 0.91             | Yellow | 7.00                       | 19.05                       | 1        |
| 236922          | Scissor Lok Device with Cable | 3.04             | Yellow | 7.00                       | 19.05                       | 1        |



## Brady cable lockout device

Locks out gate valves, gas cylinders, electrical devices and more!

- Comes with steel cable and a unique hasp lockout device
- 6 padlocks can be applied.
- Service temperature from -20 °C to 80 °C



| Order Reference | Description                     | Cable Length (m) | Cable Diameter (mm) | Colour | Max. Shackle Diameter (mm) | Min. Shackle Clearance (mm) | Quantity |
|-----------------|---------------------------------|------------------|---------------------|--------|----------------------------|-----------------------------|----------|
| 800112          | Cable Lockout Device with Cable | 1.80             | 4.76                | Red    | 8.00                       | 15.00                       | 1        |
| 800113          | Additional Cable                | 1.80             | 4.76                | Red    | -                          | 15.00                       | 1        |
| 800114          | Cable Lockout Device with Cable | 3.00             | 4.76                | Red    | 8.00                       | 15.00                       | 1        |
| 800115          | Additional Cable                | 3.00             | 4.76                | Red    | -                          | 15.00                       | 1        |



## Double loop cable

Double looped cable lockout devices are perfect in any situation that requires a flexible lockout device and a visual deterrent.

- Ideal for locking out large valves in many different industries
- Lightweight alternative to large, heavy chains
- Comes in four lengths to ensure a secure fit

| Order Reference | Cable Length (m) | Diameter (mm) | Material                   | Colour | Quantity |
|-----------------|------------------|---------------|----------------------------|--------|----------|
| 131063          | 0.61             | 4.76          | Plastic Coated Steel Cable | Red    | 1        |
| 131064          | 1.22             | 4.76          | Plastic Coated Steel Cable | Red    | 1        |
| 131065          | 1.83             | 4.76          | Plastic Coated Steel Cable | Red    | 1        |
| 131066          | 2.44             | 4.76          | Plastic Coated Steel Cable | Red    | 1        |

## Universal valve lockout

The universal lockout device is a modular system which enables you to lock out valves of different types and sizes. No other device offers such flexibility and security. There are two sizes available - large and small.

- Modular system makes your investment economical and flexible
- Can be used to lock out large levers, T-handles and other hard-to-secure mechanical devices
- Open-ended clamp fits over closed rings and wide handles
- Locks out valves in open and closed positions
- Made from glass filled nylon for rugged durability, chemical and corrosion resistant
- 2 padlocks can be applied

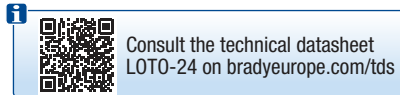

| Order Reference | Description   | Max. Handle Thickness (mm) | Max. Valve Handle Width (mm) | Max. Shackle Diameter (mm) | Min. Shackle Clearance (mm) | Cable Length (m) | Cable Diameter (mm) | Quantity |  |
|-----------------|---|----------------------------|------------------------------|----------------------------|-----------------------------|------------------|---------------------|----------|--|
| 050899          | Large Universal Valve Lockout Base Clamping Unit                        | 27.94                      | 40.64                        | 9.00                       | 20.00                       | -                | -                   | 1        |  |
| 050924          | Small Universal Valve Lockout Base Clamping Unit                        | 15.24                      | 25.40                        | 9.00                       | 20.00                       | -                | -                   | 1        |  |
| 051388          | Large Universal Valve Lockout w/ Nylon Cable & Blocking Arm             | 27.94                      | 40.64                        | 9.00                       | 20.00                       | 2.44             | 3.25 mm             | 1        |  |
| 051390          | Small Universal Valve Lockout w/ Nylon Cable & Blocking Arm             | 15.24                      | 25.40                        | 9.00                       | 20.00                       | 2.44             | 3.25 mm             | 1        |  |
| 051392          | Large Universal Valve Lockout w/ Sheathed Cable & Blocking Arm          | 27.94                      | 40.64                        | 9.00                       | 20.00                       | 2.44             | 3.25 mm             | 1        |  |
| 051394          | Small Universal Valve Lockout w/ Sheathed Cable & Blocking Arm          | 15.24                      | 25.40                        | 9.00                       | 20.00                       | 2.44             | 3.25 mm             | 1        |  |
| 051395          | Cable attachment with 2.44 metre sheathed cable. Cable diameter 3.25 mm | -                          | -                            | -                          | -                           | 2.44             | 3.25 mm             | 1        |  |
| 065402          | Small Blocking Arm  | -                          | -                            | -                          | -                           | -                | -                   | 1        |  |
| 065403          | Large Blocking Arm  | -                          | -                            | -                          | -                           | -                | -                   | 1        |  |
| 065400          | Small Universal Valve Lockout Base + Arm                                | 15.24                      | 25.40                        | 9.00                       | 20.00                       | -                | -                   | 1        |  |
| 065401          | Large Universal Valve Lockout Base + Arm                                | 27.94                      | 40.64                        | 9.00                       | 20.00                       | -                | -                   | 1        |  |

The modular construction of the Universal Lockout allows the user to add various accessories to make the device suitable for a range of valves. Simply disassemble the device and slot in the relevant accessory.

Cable attachment can be added to make device suitable for locking off gate valves.

Optional blocking arm(s) can be added to make device suitable for ball valves in closed, open or partially open positions

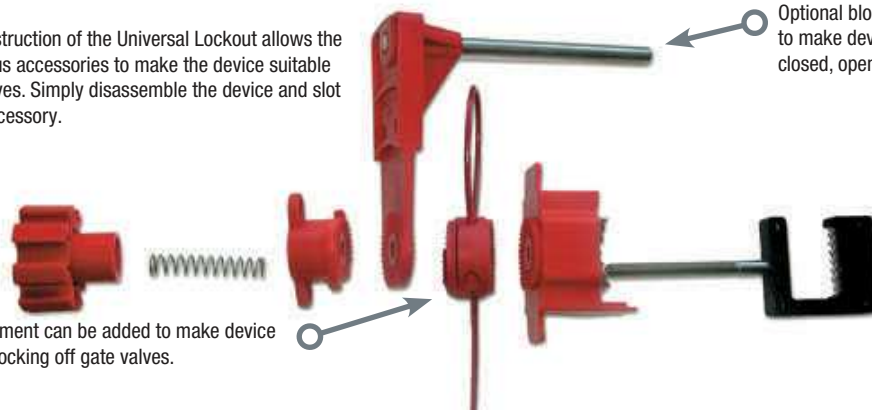

Clamp attaches to butterfly valve lever, preventing trigger handle from being squeezed. Valve cannot be repositioned



Use blocking arm to lock out quarter-turn ball valves



Use cable attachment to lock out gate valves



Use two blocking arms to lockout 3-, 4- or 5-way valves, or to lock valves in the throttled position for operational control





**i** Consult the technical datasheet LOTO-74 on [bradyeurope.com/tds](http://bradyeurope.com/tds)

## Perma-mount™ ball valve lockout

These Lockout Devices keep your critical valves ready for correct lockout. Retrofit lockout devices stay permanently in place at the point of need.

- Eliminate the need to choose and carry the correct devices for each lockout event
- Securely retain the operating handle in the 90° fully-closed position
- Two sizes fit the full range of 1 to 10 cm diameter ball valves
- Designed to withstand a wide range of environmental conditions

| Order Reference | Description                                 | Material | Width (mm) | Height (mm) | Quantity |
|-----------------|---|----------|------------|-------------|----------|
| 121541          | Perma-mount™ Ball Valve Lockout, Large size | Metal    | 92.20      | 162.80      | 1        |
| 121540          | Perma-mount™ Ball Valve Lockout, Small size | Metal    | 55.90      | 108.20      | 1        |



## Ball valve lockout

Versatile and easy-to-use device. The two halves of the device encompass the ball valve lever to secure it from inadvertent activation of the valve.

- Small device locks out valves in open and closed position for pipes from 14.50 - 52.50 mm diameter
- Large device locks out valves in closed position for pipes from 50 - 200 mm diameter
- Versatile and easy-to-use
- Made from Ultra-tough Polypropylene
- Service temperature from -20 °C to 80 °C

**i** Consult the technical datasheet LOTO-22 on [bradyeurope.com/tds](http://bradyeurope.com/tds)



| Order Reference | Colour | Pipe Diameter (mm) | Max. Shackle Diameter (mm) | Min. Shackle Clearance (mm) | Quantity |
|-----------------|--------|--------------------|----------------------------|-----------------------------|----------|
| <b>Small</b>    |        |                    |                            |                             |          |
| 800110*         | Red    | 14,50 - 52,50      | 7.24                       | 38.00                       | 1        |
| 805847          | Blue   | 14,50 - 52,50      | 7.24                       | 38.00                       | 1        |
| 805848          | Green  | 14,50 - 52,50      | 7.24                       | 38.00                       | 1        |
| 805849          | Yellow | 14,50 - 52,50      | 7.24                       | 38.00                       | 1        |
| <b>Large</b>    |        |                    |                            |                             |          |
| 800111          | Red    | 50.00 - 200.00     | 7.24                       | 38.00                       | 1        |
| 805850          | Blue   | 50.00 - 200.00     | 7.24                       | 38.00                       | 1        |
| 805851          | Green  | 50.00 - 200.00     | 7.24                       | 38.00                       | 1        |
| 805852          | Yellow | 50.00 - 200.00     | 7.24                       | 38.00                       | 1        |

\*This product meets the ATEX Equipment Directive.

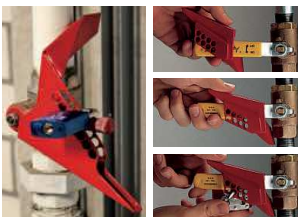

## Brady ball valve lockout

Brady ball valve lockouts are the ideal tool for securing your quarter-turn angled ball valves in the OFF position.

- Fits virtually any valve lever up to 76 mm
- Available in 2 sizes
- Service Temperature from -30 °C to 120 °C

**i** Consult the technical datasheet LOTO-23 on [bradyeurope.com/tds](http://bradyeurope.com/tds)

| Order Reference | Description                    | Material | Max. Handle Thickness (mm) | Max. Valve Handle Width (mm) | Size valve lever (mm) | Max. Shackle Diameter (mm) | Min. Shackle Clearance (mm) | # of Holes | Quantity |
|-----------------|--------------------------------|----------|----------------------------|------------------------------|-----------------------|----------------------------|-----------------------------|------------|----------|
| 065666*         | Small Brady Ball Valve Lockout | Nylon    | 7.62                       | 30.48                        | 6 - 25                | 7.00                       | 25.00                       | 8          | 1        |
| 065692          | Small Brady Ball Valve Lockout | Steel    | 6.92                       | 30.48                        | 6 - 25                | 9.53                       | 19.00                       | 6          | 1        |
| 065669          | Large Brady Ball Valve Lockout | Steel    | 12.70                      | 53.34                        | 32 - 76               | 7.00                       | 19.00                       | 15         | 1        |
| 065693          | Large Brady Ball Valve Lockout | Steel    | 12.70                      | 48.26                        | 32 - 76               | 9.53                       | 19.00                       | 7          | 1        |

\*This product meets the ATEX Equipment Directive.



## Non-conductive ball valve lockout

Intuitive and easy to place safety device.

- Locks quarter-turn ball valves in OFF position
- Made from strong polypropylene plastic, resistant to cracking, abrasion and chemical products
- Resistant to extreme temperature -46 °C to 183 °C

| Order Reference | Description                       | Colour | Height (mm) | Width (mm) | Size valve lever (mm) | Max. Shackle Diameter (mm) | Min. Shackle Clearance (mm) | Quantity |
|-----------------|-----------------------------------|--------|-------------|------------|-----------------------|----------------------------|-----------------------------|----------|
| 225340          | Non-Conductive Ball Valve Lockout | Red    | 125.00      | 95.00      | 190 - 250             | 7.00                       | 20.00                       | 1        |

## Standard gate valve lockout

The easiest device that fits your gate valve.

- Locks out gate valves with different hand wheel diameters
- Made of durable polypropylene – superior impact & chemical resistance
- Withstands temperatures from -20 °C to 150 °C
- Available in several sizes and colours
- Colours allow a coding. Transparency allows instant visibility on the valve colour and status.
- Padlock can be applied

Comes with danger labels in English, Spanish and French

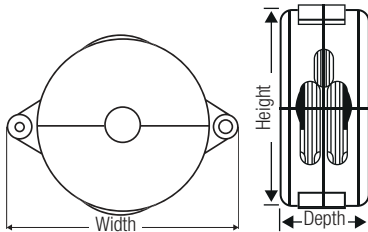

**i** For the transparent device, consult the technical datasheet LOTO-78 on [bradyeurope.com/tds](http://bradyeurope.com/tds)



**i** For the coloured device, consult the technical datasheet LOTO-7 on [bradyeurope.com/tds](http://bradyeurope.com/tds)

| Order Reference    | Hand Wheel Diameter (mm) | Height (mm) | Width (mm) | Depth (mm) | Max. Shackle Diameter (mm) | Min. Shackle Clearance (mm) | Quantity |
|--------------------|--------------------------|-------------|------------|------------|----------------------------|-----------------------------|----------|
| <b>Blue</b>        |                          |             |            |            |                            |                             |          |
| 065585             | 25 - 64                  | 80.00       | 120.10     | 35.90      | 9.53                       | 19.00                       | 1        |
| 065586             | 64 - 127                 | 141.70      | 184.80     | 50.60      | 9.53                       | 19.00                       | 1        |
| 065587             | 127 - 165                | 181.00      | 224.10     | 60.40      | 9.53                       | 19.00                       | 1        |
| 065588             | 165 - 254                | 276.20      | 318.30     | 76.20      | 9.53                       | 19.00                       | 1        |
| 065589             | 254 - 330                | 363.50      | 405.10     | 76.20      | 9.53                       | 19.00                       | 1        |
| <b>Green</b>       |                          |             |            |            |                            |                             |          |
| 065595             | 25 - 64                  | 80.00       | 120.10     | 35.90      | 9.53                       | 19.00                       | 1        |
| 065596             | 64 - 127                 | 141.70      | 184.80     | 50.60      | 9.53                       | 19.00                       | 1        |
| 065597             | 127 - 165                | 181.00      | 224.10     | 60.40      | 9.53                       | 19.00                       | 1        |
| 065598             | 165 - 254                | 276.20      | 318.30     | 76.20      | 9.53                       | 19.00                       | 1        |
| 065599             | 254 - 330                | 363.50      | 405.10     | 76.20      | 9.53                       | 19.00                       | 1        |
| <b>Red</b>         |                          |             |            |            |                            |                             |          |
| 065560*            | 25 - 64                  | 80.00       | 120.10     | 35.90      | 9.53                       | 19.00                       | 1        |
| 065561*            | 64 - 127                 | 141.70      | 184.80     | 50.60      | 9.53                       | 19.00                       | 1        |
| 065562*            | 127 - 165                | 181.00      | 224.10     | 60.40      | 9.53                       | 19.00                       | 1        |
| 065563*            | 165 - 254                | 276.20      | 318.30     | 76.20      | 9.53                       | 19.00                       | 1        |
| 065564*            | 254 - 330                | 363.50      | 405.10     | 76.20      | 9.53                       | 19.00                       | 1        |
| <b>Transparent</b> |                          |             |            |            |                            |                             |          |
| 145581             | 25 - 64                  | 80.00       | 120.10     | 35.90      | 9.70                       | 19.00                       | 1        |
| 145582             | 64 - 127                 | 141.70      | 184.80     | 50.60      | 9.70                       | 19.00                       | 1        |
| 145583             | 127 - 165                | 181.00      | 224.10     | 60.40      | 9.70                       | 19.00                       | 1        |
| 145584             | 165 - 254                | 276.20      | 318.30     | 76.20      | 9.70                       | 19.00                       | 1        |
| 145585             | 254 - 330                | 363.50      | 405.10     | 76.20      | 9.70                       | 19.00                       | 1        |
| <b>Yellow</b>      |                          |             |            |            |                            |                             |          |
| 065590             | 25 - 64                  | 80.00       | 120.10     | 35.90      | 9.53                       | 19.00                       | 1        |
| 065591             | 64 - 127                 | 141.70      | 184.80     | 50.60      | 9.53                       | 19.00                       | 1        |
| 065592             | 127 - 165                | 181.00      | 224.10     | 60.40      | 9.53                       | 19.00                       | 1        |
| 065593             | 165 - 254                | 276.20      | 318.30     | 76.20      | 9.53                       | 19.00                       | 1        |
| 065594             | 254 - 330                | 363.50      | 405.10     | 76.20      | 9.53                       | 19.00                       | 1        |

\*This product meets the ATEX Equipment Directive.



## Why use different colours

- Valves in open or closed position:
- Indicate risk levels:
- Indicate substances flowing through a valve:
- Indicate different maintenance teams:

Red = open / Green = closed  
 Red = high risk / Blue = low risk  
 Yellow = gas / Green = water  
 Red = electricians / Blue = mechanics

## Collapsible gate valve lockouts

Safely lock out gate valves from 76 up to 457 mm with the collapsible gate valve lockout.



Brady's collapsible gate valve design provides secure lockout for a wider range of valves, with the use of fewer devices. These covers easily rotate around valve handles to the fully engaged position, while also folding into smaller sizes for easy storage on maintenance carts and in lockout kits.

- Rugged, injection moulded styrene construction that can withstand harsh outdoor conditions
- Up to two padlocks can be attached directly on the collapsible gate valve lockout, and even more padlocks can be added to safeguard larger maintenance teams by using Brady's Lockout/Tagout safety hasp
- Easy to apply: rotates around valves and fully covers them to make them inoperable
- Easy to store and carry: folds to 1/3 of its full size
- Flexible: 3 size variations can lock valves ranging from 76 mm up to 457 mm
- Withstands temperatures from -40 °C to +100 °C
- Unique knockout centre accommodates OS & Y or "rising stem" valves

Comes with danger labels in English, Spanish and French

| Order Reference | Hand Wheel Diameter (mm) | Height (mm) | Depth (mm) | Diameter (mm) | Max. Shackle Diameter (mm) | Min. Shackle Clearance (mm) | Quantity |
|-----------------|--------------------------|-------------|------------|---------------|----------------------------|-----------------------------|----------|
| 148648          | 76 - 178                 | 189.00      | 78.70      | 229.40        | 9.53                       | 12.70                       | 1        |
| 148647          | 178 - 330                | 346.20      | 101.10     | 374.00        | 9.53                       | 12.70                       | 1        |
| 148646          | 330 - 457                | 472.70      | 101.10     | 500.40        | 9.53                       | 12.70                       | 1        |



Consult the technical datasheet LOTO-81 on [bradyeurope.com/tds](http://bradyeurope.com/tds)

Brady Collapsible Gate Valve Lockouts for 330 - 457 mm diam.

Brady Collapsible Gate Valve Lockouts for 178 - 330 mm diam.

Brady Collapsible Gate Valve Lockouts for 76 - 178 mm diam.



## Adjustable gate valve lockout

One device for most gate valves!

It replaces 3 conventional gate valve lockouts to reduce your costs.

- Adjusts to fit gate valves from 2.5 to 16.5 cm
- Durable polypropylene
- Resistant to extreme temperature changes from -20 °C to 80 °C
- 3 padlocks can be applied

| Order Reference | Description                   | Height (mm) | Width (mm) | Max. Shackle Diameter (mm) | Min. Shackle Clearance (mm) | Quantity |
|-----------------|-------------------------------|-------------|------------|----------------------------|-----------------------------|----------|
| 064057          | Adjustable Gate Valve Lockout | 130.00      | 209.00     | 9.40                       | 20.00                       | 1        |



Consult the technical datasheet LOTO-70 on [bradyeurope.com/tds](http://bradyeurope.com/tds)

## Brady butterfly valve lockout

Ideal to lock a butterfly valve in the OFF position

- Can be used to lock a butterfly valve in the OFF position by clamping down on the handle so that it may not be engaged or moved
- Available in two sizes

| Order Reference | Description                     | Specification                                     | Colour | Quantity |
|-----------------|---------------------------------|---|--------|----------|
| 121504          | Butterfly Valve Lockout - Small | For valve handle thicknesses of 3.2 mm to 63.5 mm | Red    | 1        |
| 121505          | Butterfly Valve Lockout - Large | For valve handle thicknesses of 50.8 mm to 102 mm | Red    | 1        |



## Universal valve lockout

Use the universal valve lockout for locking out butterfly valves!

- The clamp attaches to the butterfly valve lever, preventing the trigger handle from being squeezed
- The valve cannot be repositioned
- Rugged durability, chemical and corrosion resistance
- 2 padlocks can be applied



| Order Reference | Description                                      | Colour | Max. Shackle Diameter (mm) | Min. Shackle Clearance (mm) | Max. Valve Handle Width (mm) | Max. Handle Thickness (mm) | Quantity |
|-----------------|--|--------|----------------------------|-----------------------------|------------------------------|----------------------------|----------|
| 050899          | Large Universal Valve Lockout Base Clamping Unit | Red    | 9.00                       | 20.00                       | 40.64                        | 27.94                      | 1        |
| 050924          | Small Universal Valve Lockout Base Clamping Unit | Red    | 9.00                       | 20.00                       | 25.40                        | 15.24                      | 1        |

## Butterfly valve lockout

Created to secure your butterfly valve efficiently!

- Made of strong polypropylene plastic
- Fully dielectric (non-conductive)
- Highly resistant to cracking and abrasion
- Highly resistant to solvents and other chemical products
- Resistant to extreme temperature changes from -46 °C to 183 °C
- 2 padlocks can be applied
- Available in several colours



| Order Reference | Description             | Colour | Max. Shackle Diameter (mm) | Min. Shackle Clearance (mm) | Height (mm) | Length (mm) | Width (mm) | Quantity |
|-----------------|-------------------------|--------|----------------------------|-----------------------------|-------------|-------------|------------|----------|
| 256960          | Butterfly Valve Lockout | ● Red  | 8.00                       | 25.00                       | 70.00       | 305.00      | 102.00     | 1        |

## Pull handle butterfly valve lockout

Stop using ill-fitting, incorrect or unwieldy two-piece devices to lock out your pull handle valves. Get a safer solution that fits better and stays in place – the Pull-handle Butterfly Valve Lockout.

- Exclusive, anti-pivot lockout device fits the full range of pull handle valve sizes, from 12.70 mm to 203.80 mm diameter
- A convenient, one-piece design that stays together whether in use or in storage
- Holds up to four worker padlocks
- Secures the valve handle in any desired position, from fully closed, to partially or fully open
- 4 padlocks can be applied.

| Order Reference | Description                         | Colour | Max. Shackle Diameter (mm) | Height (mm) | Width (mm) | Depth (mm) | Quantity |
|-----------------|-------------------------------------|--------|----------------------------|-------------|------------|------------|----------|
| 170220          | Pull Handle Butterfly Valve Lockout | ● Red  | 8.00                       | 53.80       | 217.50     | 97.10      | 1        |



## Pipe blind lockout

Safe blind lockout for the widest range of pipes



The pipe blind lockout device can be applied to the widest range of pipes to easily and temporarily lock pipe blinds in place. With the pipe blind lockout, users can avoid the release of gas, steam and hazardous liquids while pipe maintenance is still ongoing.

### Increased safety and compliance

The pipe blind lockout can provide a very visual, physical barrier that acts as a deterrent for touching pipe blinds while maintenance is ongoing. When used with a properly installed pipe blind, the lockout device and a padlock reduces the risk of accidental release of pipe contents. This enables companies to increase workplace safety and also improve compliance with EU Guidelines 89/655 and the European Norm 1037.

### Non-sparking material

- The pipe blind lockout has been UL tested for ISO 80079-36:2016 Explosive Atmospheres and falls within the parameters of the norm.
- The device is built out of heavy duty 304 stainless steel with rugged, cast aluminium locking bars with a powder coated polyester finish.

### Widest range of pipes

- With 3 sizes to choose from, Brady's pipe blind lockout is applicable on the widest range of pipes, including all pipe diameters from 13.20 mm to 1219.20 mm.
- The device's extendable locking arm enables users to optionally lock not 1, but 2 pipe bolt sets for additional security.
- Up to 4 workers can apply a padlock directly on the device.
- The device can be used for standard and recessed bolts.



| Order Reference                   | 149228                            | 149229                      | 149230                     |
|-----------------------------------|-----------------------------------|-----------------------------|----------------------------|
| Description                       | Pipe Blind Lockout Device - Small | Pipe Blind Lockout - Medium | Pipe Blind Lockout - Large |
| Recommended Nut Diameter          | 13.00 - 19.00 mm                  | 23.00 - 32.00 mm            | 35.00 - 48.00 mm           |
| Max. Nut Diameter                 | 35.00 mm                          | 57.00 mm                    | 84.00 mm                   |
| Hand Wheel Diameter (mm)          | 13 - 76                           | 76 - 355                    | 355 - 1219                 |
| Pipe Flange Thickness Range       | 41.00 - 206.00 mm                 | 95.00 - 286.00 mm           | 205.00 - 464.00 mm         |
| Max. Shackle Diameter (mm)        | 7.00                              | 7.00                        | 7.00                       |
| Min. Shackle Clearance (mm)       | 19.05                             | 19.05                       | 19.05                      |
| Height (mm)                       | 106.00 mm                         | 127.00 mm                   | 154.00 mm                  |
| Length (mm)                       | 371.00 mm                         | 447.00 mm                   | 625.00 mm                  |
| Width (mm)                        | 70.00 mm                          | 114.00 mm                   | 168.00 mm                  |
| Min. - Maks. Çalışma Sıcaklığı °C | -40 °C - 90 °C                    | -40 °C - 90 °C              | -40 °C - 90 °C             |



Consult the technical datasheet LOTO-90 on

[www.bradyeurope.com/tds](http://www.bradyeurope.com/tds)



Increase safety and compliance with the pipe blind lockout applicable on the widest range of pipes. Get started today at: [www.bradyeurope.com/PipeBlindLockout](http://www.bradyeurope.com/PipeBlindLockout)

## Plug valve/drinking fountain lockout

With this innovative device you can cover the spout of most drinking fountains to prevent use, and keep hands off a high-touch area

- Keep the water flowing on bottle-filling stations connected to the fountain so people can stay hydrated
- Lock out standard plug valves with a stem diameter ranging from 9.53 mm to 63.50 mm when pandemic concerns are over.



| Order Reference | Specification                          | Material      | Max. Shackle Diameter (mm) | Height (mm) | Diameter (mm) | Quantity |
|-----------------|--|---------------|----------------------------|-------------|---------------|----------|
| 113233          | Base Cover Plug Valve Lockout 53.98 mm | Polypropylene | 9.40                       | 101.60      | 119.63        | 1        |

## Plug valve lockout

Effective fit for difficult-to-secure plug valves

- Durable and tamper-resistant
- Compact in size and easy to use
- Several sizes to fit most 25 to 203 mm diameter manually-actuated plug valves.
- Service temperatures -20 °C to 80 °C
- 1 padlock can be applied



| Order Reference | Specification                          | Material      | Max. Shackle Diameter (mm) | Height (mm) | Diameter (mm) | Quantity |
|-----------------|--|---------------|----------------------------|-------------|---------------|----------|
| 113231          | Base Cover Plug Valve Lockout 22.23 mm | Polypropylene | 9.30                       | 76.20       | 81.40         | 1        |
| 113232          | Base Cover Plug Valve Lockout 34.93 mm | Polypropylene | 9.30                       | 76.20       | 81.40         | 1        |
| 113233          | Base Cover Plug Valve Lockout 53.98 mm | Polypropylene | 9.30                       | 101.60      | 119.60        | 1        |
| 113234          | Base Cover Plug Valve Lockout 63.50 mm | Polypropylene | 9.30                       | 101.60      | 119.60        | 1        |

Consult the technical datasheet LOTO-52 on [bradyeurope.com/tds](http://bradyeurope.com/tds)

## Cylinder tank lockout

Rugged polystyrene plastic device used to lockout cylinder tanks, including propane tanks on fork lift trucks and stand-alone propane tanks.

- Designed to fit in tight spaces
- Valve stem hole is 31.5 mm in diameter
- 2 padlocks can be applied.

| Order Reference | Description           | Colour | Max. Shackle Diameter (mm) | Min. Shackle Clearance (mm) | Quantity |
|-----------------|-----------------------|--------|----------------------------|-----------------------------|----------|
| 046139          | Cylinder Tank Lockout | Red    | 6.50                       | 20.00                       | 1        |



## Gas cylinder lockout

No need to match your lockout device to varying diameters and threads of cylinder caps.

- Prevents access to the main cylinder valve
- Accommodates neck rings up to 88 mm diameter
- Install in seconds to save time
- 1 padlock can be applied

| Order Reference | Description          | Height (mm) | Diameter (mm) | Max. Shackle Diameter (mm) | Min. Shackle Clearance (mm) | Quantity |
|-----------------|----------------------|-------------|---------------|----------------------------|-----------------------------|----------|
| 045629          | Gas Cylinder Lockout | 158.80      | 88.10         | 7.00                       | 20.00                       | 1        |



Consult the technical datasheet LOTO-51 on [bradyeurope.com/tds](http://bradyeurope.com/tds)

## SMC airline regulator

Disables air supply to the equipment being serviced while allowing other equipment, sharing the same air supply, to stay active.

- The device regulator can be locked in ON, OFF or THROTTLED positions
- Easy Installation: remove snap cap, install lockout on regulator rod, snap replacement cap on regulator
- 1 padlock can be applied
- Comes with lockout, cap and allen key



| Order Reference | Description   | Colour | Diameter (mm) | Max. Shackle Diameter (mm) | Quantity |
|-----------------|---|--------|---------------|----------------------------|----------|
| 064540          | Intermediate Air Line Regulator for SMC Models AR3000 / NAR3000 | Red    | 39.30         | 3.80                       | 1        |
| 064539          | Miniature Air Line Regulator for SMC models AR2000 / NAR2000    | Red    | 39.30         | 3.80                       | 1        |

Consult the technical datasheet LOTO-48 on [bradyeurope.com/tds](http://bradyeurope.com/tds)

## Pneumatic quick-disconnect lockout

Isolates pneumatic energy without the expense and inconvenience of installing in-line lockout valves.

- Device is applied to the male fitting, isolating equipment from all compressed air sources
- Accommodates the majority of 6 mm, 9 mm and 12 mm male fittings
- Hole in centre of device allows for permanent storage on air hose and a loop on the side can be used to hang the hose and lockout device
- 1 padlock can be applied

| Order Reference | Description                        | Colour | Max. Shackle Diameter (mm) | Min. Shackle Clearance (mm) | Quantity |
|-----------------|------------------------------------|--------|----------------------------|-----------------------------|----------|
| 064221          | Pneumatic Quick-Disconnect Lockout | Red    | 7.84                       | 20.00                       | 1        |
| 065645          | Pneumatic Quick-Disconnect Lockout | Red    | 7.84                       | 20.00                       | 6        |

Consult the technical datasheet LOTO-47 on [bradyeurope.com/tds](http://bradyeurope.com/tds)



## Miniature circuit breaker lockout

A safe and effective method for locking out European Circuit Breakers as it fits most of their existing types.

- Miniature breaker lockout unique in its kind = requires NO TOOLS to install
- The lockout easily installs with the aid of a Push Button
- The tie-bar style lockout has a convenient thumb wheel for quick application
- Suitable for single, multi-pole and rotary breakers
- Made from glass-filled nylon
- Available in single or six pack
- 1 padlock can be applied

Recommended to use in combination with a padlock with a minimum shackle diameter of 6 mm for added safety.

| Order Reference | Description   | Max. Shackle Diameter (mm) | Quantity |
|-----------------|---|----------------------------|----------|
| 1 Kit / Piece   |   |                            |          |
| 805853          | Miniature Breaker Lockout Demo Kit*                   | 7.00                       | 1        |
| 1 Piece / Pack  |   |                            |          |
| 090847          | Miniature Circuit Breaker Lockouts - Pin-In Standard  | 7.00                       | 1        |
| 090844          | Miniature Circuit Breaker Lockouts - Pin-Out Standard | 7.00                       | 1        |
| 090850          | Miniature Circuit Breaker Lockouts - Pin-Out Wide     | 7.00                       | 1        |
| 090853          | Miniature Circuit Breaker Lockouts - Tie-Bar          | 7.00                       | 1        |
| 149433          | Miniature Circuit Breaker - Pin-out Wide (ABB-MS325)  | 8.13                       | 1        |
| 6 Pieces / Pack |   |                            |          |
| 090848          | Miniature Circuit Breaker Lockouts - Pin-In Standard  | 7.00                       | 6        |
| 090845          | Miniature Circuit Breaker Lockouts - Pin-Out Standard | 7.00                       | 6        |
| 090851          | Miniature Circuit Breaker Lockouts - Pin-Out Wide     | 7.00                       | 6        |
| 090854          | Miniature Circuit Breaker Lockouts - Tie-Bar          | 7.00                       | 6        |
| 149434          | Miniature Circuit Breaker - Pin-out Wide (ABB-MS325)  | 8.13                       | 6        |

\* Kit contains 1 part of each (090874, 090844, 090850, 090853, 149433, 149514)



Consult the technical datasheet LOTO-1 on bradyeurope.com/tds



Consult the technical datasheet LOTO-25 on bradyeurope.com/tds



Consult the technical datasheet LOTO-26 on bradyeurope.com/tds



Consult the technical datasheet LOTO-27 on bradyeurope.com/tds



Consult the technical datasheet LOTO-95 on bradyeurope.com/tds

## EZ Panel Loc™ system

Covers most 120V-277V breakers!

- Works on wide range of breakers, including single- and multi-pole configurations
- Makes use of unique lock rail system
- Allows panel door to be closed even when lockouts are in place
- Accommodates multiple locks, facilitating group lockout activity without hasps
- Keeps weight off the breakers, protecting delicate electrical components from damage
- Positions locks and tags outside the panel, making sure lockout activity is clearly visible to anyone in the area

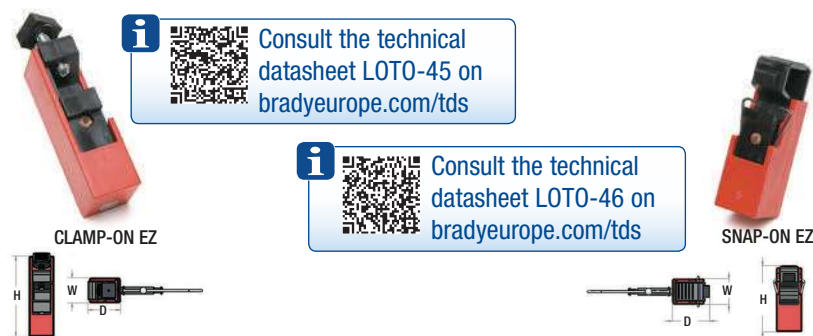

| Order Reference | Description                            | Depth (mm) | Width (mm) | Height (mm) | Cable Length (m) | Quantity |
|-----------------|--|------------|------------|-------------|------------------|----------|
| 051252          | EZ Panel Loc™ Snap-On Breaker Lockout  | 24.50      | 18.80      | 49.50       | 0.61             | 1        |
| 065815          | EZ Panel Loc™ Snap-On Breaker Lockout  | 24.50      | 18.80      | 49.50       | 0.61             | 6        |
| 051254          | EZ Panel Loc™ Clamp-On Breaker Lockout | 24.50      | 18.80      | 60.50       | 0.61             | 1        |
| 065810          | EZ Panel Loc™ Clamp-On Breaker Lockout | 24.50      | 18.80      | 60.50       | 0.61             | 6        |
| 051256          | EZ Panel Loc Lock Rails - 101.60 mm    | 17.78      | 20.32      | 101.60      | -                | 1        |
| 065814          | EZ Panel Loc Lock Rails - 101.60 mm    | 17.78      | 20.32      | 101.60      | -                | 6        |
| 051258          | EZ Panel Loc Lock Rails - 203.20 mm    | 17.78      | 20.32      | 203.20      | -                | 1        |
| 051260          | EZ Panel Loc Lock Rails - 203.20 mm    | 17.78      | 20.32      | 203.20      | -                | 6        |

Lockout device is unlocked by inserting and turning the black plastic key

1. Expose the super-bond adhesive on back of rail. Permanently affix to any location on the panel.

2. Attach the lockout device to the breaker and snap into locked position

3. Pass plastic key through lock rail and attach lock, preventing key from sliding down cable and opening lockout device

4. For group lockouts, run key through multiple loops in lock rail and apply locks. No hasps required! (Not recommended for use with multilock hasps)

5. Low-profile lockouts allow panel doors to be closed on most breaker panels.

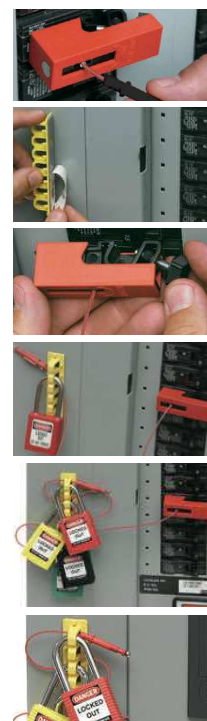

See page 88 for a circuit breaker compatibility chart.

## TAGLOCK™ circuit breaker securing devices

Step up safety and compliance with physically secure tagout for up to four workers.

- Quick and easy to apply with a nylon cable tie and the worker's ID tag
- Up to 4 workers can apply a nylon cable tie and their ID tag
- Compatible with GE, ITE, Sylvania, Challenger, Bryan, General Switch Co., Westinghouse, etc., breakers
- Alternatively, every model can be locked with 1 padlock
- Every TAGLOCK device is supplied with 2 nylon cable ties

### TAGLOCK

| Order Reference | Description   | Quantity | TDS Number |
|-----------------|---|----------|------------|
| 148685          | TagLock Circuit Breaker: Oversized Clamp-on - 25/pk | 25       | LOTO-84    |
| 148686          | TagLock Circuit Breaker: 480/600V Clamp-on - 25/pk  | 25       | LOTO-83    |
| 148687          | TagLock Circuit Breaker: 480/600V Clamp-on - 6/pk   | 6        | LOTO-83    |
| 148688          | TagLock Circuit Breaker: Switch - 6/pk              | 6        | LOTO-86    |
| 148689          | TagLock Circuit Breaker: Snap-on                    | 1        | LOTO-87    |
| 148690          | TagLock Circuit Breaker: 120/277V Clamp-on          | 1        | LOTO-82    |
| 148691          | TagLock Circuit Breaker: Oversized Clamp-on - 6/pk  | 6        | LOTO-84    |
| 148692          | TagLock Circuit Breaker: Oversized Clamp-on         | 1        | LOTO-84    |
| 148693          | TagLock Circuit Breaker: Snap-on - 6/pk             | 6        | LOTO-87    |
| 148694          | TagLock Circuit Breaker: Snap-on - 50/pk            | 50       | LOTO-87    |
| 148695          | TagLock Circuit Breaker: Multi-pole - 50/pk         | 50       | LOTO-85    |
| 148696          | TagLock Circuit Breaker: Switch                     | 1        | LOTO-86    |
| 148697          | TagLock Circuit Breaker: Multi-pole - 6/pk          | 6        | LOTO-85    |
| 148698          | TagLock Circuit Breaker: 120/277V Clamp-on - 6/pk   | 6        | LOTO-82    |
| 148699          | TagLock Circuit Breaker: 120/277V Clamp-on - 50/pk  | 50       | LOTO--82   |
| 148700          | TagLock Circuit Breaker: Switch - 50/pk             | 50       | LOTO-86    |
| 148701          | TagLock Circuit Breaker: 480/600V Clamp-on          | 1        | LOTO-83    |
| 148702          | TagLock Circuit Breaker: Multi-pole                 | 1        | LOTO-85    |

### Nylon Ties

| Order Reference | Colour  | Width (mm) | Length (mm) | Quantity |
|-----------------|---------|------------|-------------|----------|
| 196351          | Red     | 3.60       | 200.00      | 100      |
| 229960          | Green   | 3.60       | 205.00      | 100      |
| 622652          | Natural | 4.80       | 190.00      | 100      |

### Mini Tag



| Order Reference | Legend                 | Height (mm) | Width (mm) | Quantity |
|-----------------|------------------------|-------------|------------|----------|
| 148824          | DANGER, DO NOT OPERATE | 63.50       | 50.80      | 25       |

### Models and usages :

- **Clamp-on:** works on wide range of single-pole and internal-trip multi-pole breakers, use thumbscrews to clamp lockout securely onto switch tongue, then pull cover over thumbscrew and lock with a nylon tie/padlock in place to prevent clamp from being loosened. Oversized, 480/600V and 120/277V models are available
- **Multi-pole:** works with most two or three pole breakers utilising a tie-bar, use thumbscrews to clamp lockout securely over tie-bar, then insert nylon tie/padlock to prevent clamp from being loosened
- **Switch:** works on wide range of breakers, including single- and multi-pole configurations and allows panel door to be closed even when lockouts are in place
- **Snap-on:** designed for breakers that have holes in the switch tongue, dual cavities accommodate different size switch tongues

### Clamp-on models

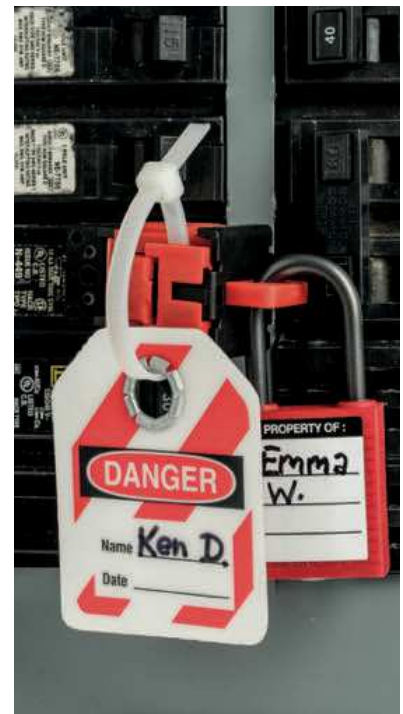
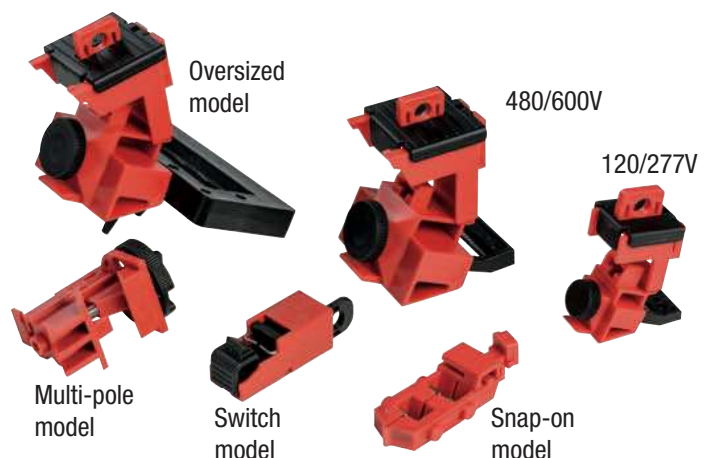

Can be secured with cable ties and/or a safety lock

**i** Please visit our website [www.bradyeurope.com](http://www.bradyeurope.com) or see page 76 for a selection of tags

**i** Consult the technical datasheets on [www.bradyeurope.com/tds](http://www.bradyeurope.com/tds)

**i**  Get started today at [www.bradyeurope.com/TAGLOCK](http://www.bradyeurope.com/TAGLOCK) Watch the TAGLOCK video on Brady's YouTube™ channel.





## 480-600V breaker lockout

Perfect for locking out oversized and irregularly shaped switches.

- Self adhesive backed rails are permanently installed onto an electrical panel – simply clean panel surface and adhere – no drilling required!
- Red blocking bar indicates locked “off
- Green blocking bar indicates locked “on
- 1 padlock can be applied

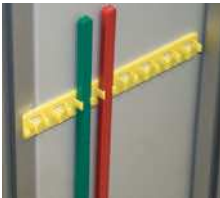

Breaker Blocker Components - Blocking Bar Holder

| Order Reference | Description   | Colour | Length (mm) | Height (mm) | Max. Shackle Diameter (mm) | Min. Shackle Clearance (mm) | Max. Switch Width (mm) | Quantity |
|-----------------|---|--------|-------------|-------------|----------------------------|-----------------------------|------------------------|----------|
| 090891**        | 480-600V Breaker Lockout Kit*                             | -      | -           | 20.32       | 6.50                       | 20.00                       | 150.00                 | 1        |
| 051264          | Breaker Blocker Components - 101 mm Yellow Mounting Rails | Yellow | 101.60      | 20.32       | -                          | -                           | -                      | 2        |
| 090893          | Breaker Blocker Components - 190 mm Green Blocking Bar    | Green  | 190.00      | -           | -                          | -                           | -                      | 5        |
| 090892          | Breaker Blocker Components - 190 mm Red Blocking Bar      | Red    | 190.00      | -           | -                          | -                           | -                      | 5        |
| 051265          | Breaker Blocker Components - Blocking Bar Holder          | Yellow | 150.00      | 20.32       | -                          | -                           | -                      | 5        |

\*Kit includes: 2 Yellow mounting rails, 1 red blocking bar, 1 green blocking bar and 3 alcohol wipes.

\*\*This product meets the ATEX Equipment Directive.



## Universal multi-pole breaker lockout

Universal multi-pole lockout works with most two or three pole breakers utilising a tie-bar.

- Compatible with GE, ITE, Sylvania, Challenger, Bryan, Westinghouse, General Switch Co. ...
- Use thumbscrews to clamp lockout securely over tie-bar, then insert lock to prevent clamp from being loosened
- Made of durable Polypropylene & Moulded Glass-filled Nylon
- 1 padlock can be applied

| Order Reference | Description                          | Max. Shackle Diameter (mm) | Min. Shackle Clearance (mm) | Packaging |
|-----------------|--------------------------------------|----------------------------|-----------------------------|-----------|
| 066320          | Universal Multi-Pole Breaker Lockout | 7.00                       | 20.00                       | 6         |
| 066321*         | Universal Multi-Pole Breaker Lockout | 7.00                       | 20.00                       | 1         |

\*This product meets the ATEX Equipment Directive.



## Economy multi-pole breaker lockout

Economical solution designed to fit multi-pole breakers!

- Quick and easy to apply
- 1 padlock can be applied.

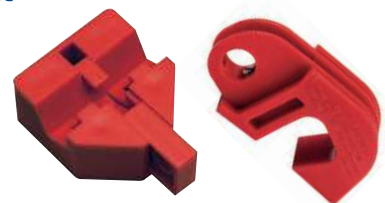

| Order Reference | Description                        | Max. Shackle Diameter (mm) | Min. Shackle Clearance (mm) | Quantity |
|-----------------|------------------------------------|----------------------------|-----------------------------|----------|
| 836597          | Compact Circuit Breaker Lockout    | -                          | -                           | 1        |
| 805814          | Economy Multi-Pole Breaker Lockout | 7.00                       | 20.00                       | 1        |

Consult the technical datasheet LOTO-33 on [bradyeurope.com/tds](http://bradyeurope.com/tds)



## Single pole circuit breaker lockout

Quick and easy – just snap in place and apply a lock!

- Designed for breakers that have holes in the switch tongue
- Dual cavities accommodate different size switch tongues
- 1 padlock can be applied

| Order Reference | Description                         | Max. Shackle Diameter (mm) | Min. Shackle Clearance (mm) | Width (mm) | Depth (mm) | Quantity |
|-----------------|-------------------------------------|----------------------------|-----------------------------|------------|------------|----------|
| 836597          | Compact Circuit Breaker Lockout     | -                          | -                           | -          | -          | 1        |
| 065387*         | Single Pole Circuit Breaker Lockout | 7.16                       | 12.70                       | 30.23      | 8.38       | 1        |
| 065688          | Single Pole Circuit Breaker Lockout | 7.16                       | 12.70                       | 30.23      | 8.38       | 6        |

\*This product meets the ATEX Equipment Directive.

## Universal mini circuit breaker lockout

Easy to apply to a wide range of circuit breakers from various manufacturers (Schneider IC60 series, Siemens 5SX21, Hager MFN716, ABB 2CDS25, ABB S202U-K50).

- Fastened using an attached screw that is easy to handle
- Fastening the screw pushes out a hole for a Lockout/Tagout padlock shackle
- 1 padlock can be applied

| Order Reference | Description                            | Max. Shackle Diameter (mm) | Width (mm) | Depth (mm) | Quantity |
|-----------------|--|----------------------------|------------|------------|----------|
| 149514          | Universal Mini Circuit Breaker Lockout | 7.87                       | 12.70      | 63.50      | 1        |
| 149515          | Universal Mini Circuit Breaker Lockout | 7.87                       | 12.70      | 63.50      | 6        |



**i** Consult the technical datasheet LOTO-96 on [bradyeurope.com/tds](http://bradyeurope.com/tds)

## “No-hole” circuit breaker lockout

Works on wide range or single-pole and internal-trip multi-pole breakers.

- Use thumbscrews to clamp lockout securely onto switch tongue, then pull cover over thumbscrew and lock in place to prevent clamp from being loosened
- Made of rugged Polypropylene & Moulded Glass-filled Nylon
- Detachable cleats (included) expand the range of applicable breakers
- 1 padlock can be applied

| Order Reference | Description  | Height (mm) | Width (mm) | Depth (mm) | Max. Shackle Diameter (mm) | Max. Switch Width (mm) | Quantity |
|-----------------|--|-------------|------------|------------|----------------------------|------------------------|----------|
| 065396          | No Hole Circuit Breaker Lockout - 277 Volt Device      | 24.10       | 56.00      | 25.40      | 7.00                       | 16.00                  | 1        |
| 065965          | No Hole Circuit Breaker Lockout - 277 Volt Device      | 24.10       | 56.00      | 25.40      | 7.00                       | 16.00                  | 6        |
| 065397*         | No Hole Circuit Breaker Lockout - 480-600 Volts Device | 40.30       | 82.60      | 55.20      | 7.00                       | 38.00                  | 1        |
| 065966          | No Hole Circuit Breaker Lockout - 480-600 Volts Device | 40.30       | 82.60      | 55.20      | 7.00                       | 38.00                  | 6        |
| 065404          | Extra Cleats for 120/277V Lockout                      | 50.74       | 28.70      | 7.37       | -                          | -                      | 6        |
| 065406          | Extra Cleats for 480/600V Lockout                      | 50.74       | 28.70      | 7.37       | -                          | -                      | 6        |

\*This product meets the ATEX Equipment Directive.



**i** Lockout: consult the technical datasheet LOTO-14 on [bradyeurope.com/tds](http://bradyeurope.com/tds)

**i** Cleats: consult the technical datasheet LOTO-17 on [bradyeurope.com/tds](http://bradyeurope.com/tds)

## Oversized breaker lockout device

- Oversized 480-600 Volt frame lockout, fits breakers up to 57.15 mm wide by 22.20 mm thick
- 1 padlock can be applied

| Order Reference | Specification                    | Additional Information   | Max. Shackle Diameter (mm) | Min. Shackle Clearance (mm) | Max. Switch Width (mm) | Quantity |
|-----------------|----------------------------------|--|----------------------------|-----------------------------|------------------------|----------|
| 065321          | Oversized Breaker Lockout Device | 480-600 Volt, fits breakers up to 57.15 mm wide by 22.2 mm thick | 7.00                       | 20.00                       | 57.15                  | 6        |
| 065329          | Oversized Breaker Lockout Device | 480-600 Volt, fits breakers up to 57.15 mm wide by 22.2 mm thick | 7.00                       | 20.00                       | 57.15                  | 1        |



**i** Consult the technical datasheet LOTO-39 on [bradyeurope.com/tds](http://bradyeurope.com/tds)

## Fuse lockout

Designed to prevent the unintended re-energisation of a fuse. Fits most fuse holders between 20 Amps and 400 Amps and creates a universal approach to locking out your fuses.

- Material: Nylon with ZP metal slotted set screw
- Instructions: clamp onto the fuse holder and use a small flathead screwdriver to tighten the set screw in the device. Place a padlock through the hole to prevent access to the set screw.
- Label applied stating: DANGER DO NOT REMOVE LOCKED OUT
- 1 padlock can be applied

| Order Reference | Description                 | Height (mm) | Width (mm) | Depth (mm) | Packaging |
|-----------------|-----------------------------|-------------|------------|------------|-----------|
| 873367          | Fuse Lockout Device 20-400A | 35.00       | 15.00      | 60.00      | 1         |



**i** See page 88 for a circuit breaker compatibility chart.



## Fuse lockout - insulation plugs

- Patented insulation plugs protect people working on current circuits against unauthorised use and inadvertent switching on of power
- Insulation plug is placed into a fuse base by means of a special screwdriver (sold separately 812713) instead of fuse link and screw cap.

| Order Reference | Description   | Packaging |
|-----------------|---|-----------|
| 812711          | Industry - Insulation Plugs DII                                 | 1         |
| 812712          | Industry - Insulation Plugs DIII                                | 1         |
| 812713          | Industry Insulation Plug Screwdriver                            | 1         |
| 812714          | Low Voltage NV Fuse Rails Size NH00                             | 1         |
| 812715          | Low Voltage NV Fuse Rails Size NH1 - NH3                        | 1         |
| 850957          | Low Voltage NV Fuse Rails Set Sizes NH00 & NH1 - NH3 with glove | 1         |
| 850958          | Industry Insulation Plug Set DII & DIII                         | 1         |



## 3-in-1 electrical plug lockout

Accommodates high and low-voltage plugs up to 76.0 mm in diameter and 139.0 mm in length.

- Two sliding top lids can be used individually or together to accommodate small, medium and large diameter cords up to 31mm
- Made in bright yellow thermoplastic
- With English instruction labels
- 1 padlock can be applied

| Order Reference | Description                    | Colour | Height (mm) | Diameter (mm) | Cable Diameter (mm) | Quantity |
|-----------------|--------------------------------|--------|-------------|---------------|---------------------|----------|
| 045842          | 3-in-1 Electrical Plug Lockout | Yellow | 158.75      | 88.14         | 31.00               | 1        |

## Lockout devices for plug connections

Highly effective against unauthorised or incorrect use of electrical equipment.

- Simple to use
- Especially developed to secure all types of plugs

| Order Reference | Description                                  | Colour | Max. Shackle Diameter (mm) | Min. Shackle Clearance (mm) | Width (mm) | Cable Diameter (mm) | Max number of padlocks applied | Quantity |
|-----------------|--|--------|----------------------------|-----------------------------|------------|---------------------|--------------------------------|----------|
| 065675          | Lockout Devices for Plug Connections - Large | Red    | 7.00                       | 20.00                       | 178.00     | 22.00               | 4                              | 1        |
| 065674*         | Lockout Devices for Plug Connections - Small | Red    | 7.00                       | 20.00                       | 88.90      | 10.00               | 2                              | 1        |

\*This product meets the ATEX Equipment Directive.



## Detachable power cord plug lockout

Ideal tool for preventing tampering with office equipment, computers, peripheral equipment and power supplies.

- The device works as a block to prevent power going to the socket by simply plugging into the socket and twisting.
- Compact size and lightweight, nylon construction make this device easily portable.
- 1 padlock can be applied

| Order Reference | Description                        | Colour         | Quantity |
|-----------------|------------------------------------|----------------|----------|
| 148081          | Detachable Power Cord Plug Lockout | Black & Orange | 1        |



## Stoppower™ plug lockouts

Device is simple to use - just slide over cord prongs and lock with key.

- Ideal for office equipment and other frequently locked out cords
- Cord cannot be plugged in with Stoppower in place
- For use on 2 or 3 pronged polarised plugs
- Device cannot be removed without a key
- Standard devices are individually keyed

| Order Reference | Description            | Colour | Quantity |
|-----------------|------------------------|--------|----------|
| 065673          | Stoppower Plug Lockout | Red    | 1        |



## Hubbell plugout for industrial plug connections

Effectively secures all industrial plug connections.

- Fits the majority of your heavier industrial plug applications
- Small version accepts plugs with maximum 69.85 mm diameter and 120.65 mm length with 25.40 mm cord.

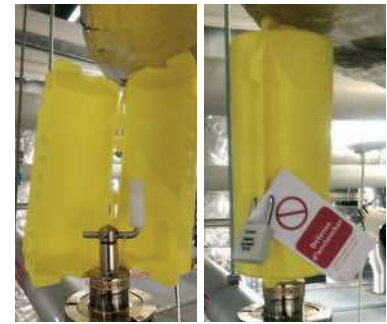
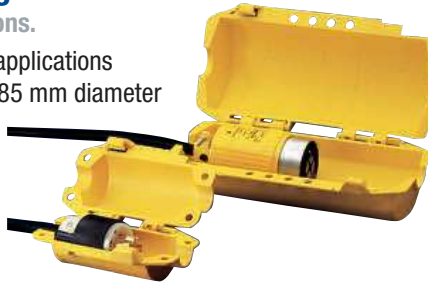

| Order Reference | Specification           | Colour | Height (mm) | Width (mm) | Plug Length (mm) | Plug Diameter (mm) | Max. Shackle Diameter (mm) | Cable Diameter (mm) | Min. Shackle Clearance (mm) | Max number of padlocks applied | Quantity |
|-----------------|-------------------------|--------|-------------|------------|------------------|--------------------|----------------------------|---------------------|-----------------------------|--------------------------------|----------|
| 065695          | Hubbell Plugout - Small | Yellow | 80.00       | 106.00     | 120.00           | 70.00              | 7.00                       | 25.00               | 20.00                       | 4                              | 1        |
| 065968          | Hubbell Plugout - Large | Yellow | 120.00      | 120.00     | 250.00           | 100.00             | 7.00                       | 35.00               | 20.00                       | 4                              | 1        |

## Large electrical/pneumatic lockout

Accommodates a large variety of electrical plugs up to 89 mm diameter and 127 mm in length as well as male air hose connectors.

- Works on 110V, 220V and 550V plugs
- Made of Polystyrene material
- 4 padlocks can be applied



| Order Reference | Description                        | Colour | Max. Shackle Diameter (mm) | Min. Shackle Clearance (mm) | Plug Diameter (mm) | Plug Length (mm) | Quantity |
|-----------------|------------------------------------|--------|----------------------------|-----------------------------|--------------------|------------------|----------|
| 800126          | Large Electrical/Pneumatic Lockout | Red    | 7.00                       | 20.00                       | 89.00              | 127.00           | 1        |

**i**  Consult the technical datasheet LOTO-30 on [bradyeurope.com/tds](http://bradyeurope.com/tds)

## Pendant Lockout Safety Cover

No undesired crane control

- Completely cover crane or hoist pendant controls to prevent anyone from pressing any pendant buttons before removing up to 4 padlocks.
- Can be applied just like a bag, extended to cover all pendant controls from 10 to 45 cm long and can be folded flat for easy transport.

| Order Reference | Description                          | Depth (mm) | Length (mm) | Width (mm) | Max. Shackle Diameter (mm) | Quantity |
|-----------------|--------------------------------------|------------|-------------|------------|----------------------------|----------|
| 150587          | Pendant Control Safety Cover         | 50.80      | 508.00      | 133.35     | 9.53                       | 1        |
| 151252          | Pendant Control Safety Cover - Large | 50.80      | 1016.00     | 228.60     | 9.53                       | 1        |



**i**  Consult the technical datasheet LOTO-98 on [bradyeurope.com/tds](http://bradyeurope.com/tds)

## Lockout bag

For securing plugs on portable appliances, cables on pneumatic connectors, crane pendants, etc.

- Made of rugged canvas with drawstring
- Can be locked closed
- Legend: LOCK OUT FOR SAFETY

| Order Reference | Description  | Height (mm) | Length (mm) | Quantity |
|-----------------|--|-------------|-------------|----------|
| 065780          | Lockout bag made of rugged canvas with drawstrings | -           | 457.20      | 1        |





## Twist and Secure™ push button & e-stop covers

Made to temporarily prevent access to the on/off and emergency stop controls for production and facility utility operating equipment.

- Fast and convenient lockout at the point of need.
- One time installation of the low profile, unobtrusive lockout base.
- Provides an obvious, visual indication that the equipment control button is locked out, as well as a view through the translucent cover of the ON/OFF status of E-Stop buttons.
- Standardised bases allow authorised workers to apply a single provided cover to any of numerous equipment control buttons.

**i** Consult the technical datasheet LOTO-72 on [bradyeurope.com/tds](http://bradyeurope.com/tds)



**i** Watch the push button lockout video on Brady's YouTube™ channel.

### Total Package

| Order Reference | Description  | Height (mm) | Quantity |
|-----------------|--|-------------|----------|
| 139793          | Push Button Lockout Device (16 mm), Clear, with Standard Cover | 50.00       | 1        |
| 139794          | Push Button Lockout Device (16 mm), Clear, with Tall Cover     | 80.00       | 1        |
| 134018          | Push Button Lockout Device (16 mm), Red, with Standard Cover   | 50.00       | 1        |
| 130819          | Push Button Lockout Device (16 mm), Red, with Tall Cover       | 80.00       | 1        |
| 139795          | Push Button Lockout Device (22 mm), Clear, with Standard Cover | 50.00       | 1        |
| 130820          | Push Button Lockout Device (22 mm), Red, with Standard Cover   | 50.00       | 1        |
| 139796          | Push Button Lockout Device (30 mm), Clear, with Standard Cover | 55.00       | 1        |
| 130821          | Push Button Lockout Device (30 mm), Red, with Standard Cover   | 55.00       | 1        |

### Package without cover

| Order Reference | Description                                  | Quantity |
|-----------------|--|----------|
| 130822          | 16 mm Push Button/E-Stop Lockout Bases, 5 Pk | 5        |
| 130823          | 22 mm Push Button/E-Stop Lockout Bases 5 Pk  | 5        |
| 130824          | 30 mm Push Button/E-Stop Lockout Bases 5 Pk  | 5        |

Supplied with 5 clear labels, 5 red labels and 5 yellow labels

## Push button lockouts

Guard against unauthorised operation or accidental activation.

- Two sizes to accommodate standard NEMA 30.5 mm and IEC 22.5 mm buttons
- Emergency stop safety covers for permanent installation over push/pull or twist-release emergency stops - made from durable metal bar locks button in the depressed (off) position when lock shackle is inserted
- Push button safety covers to completely cover buttons and prevent access.



Emergency Stop Safety Cover for 22.50 mm button - IEC

Emergency Stop Safety Cover for 30.50 mm button - NEMA

Push Button Safety Cover - IEC

Push Button Safety Cover - NEMA

| Order Reference | Description  | Height (mm) | Depth (mm) | Button Type | Button Size | Quantity |
|-----------------|--|-------------|------------|-------------|-------------|----------|
| 104601          | Emergency Stop Safety Cover for 22.50 mm button - IEC  | 20.19       | 41.90      | IEC         | 22.50       | 1        |
| 104600          | Emergency Stop Safety Cover for 30.50 mm button - NEMA | 33.80       | 41.90      | NEMA        | 30.50       | 1        |
| 104603          | Push Button Safety Cover - IEC                         | 58.40       | 34.10      | IEC         | -           | 1        |
| 104602          | Push Button Safety Cover - NEMA                        | 49.02       | -          | NEMA        | -           | 1        |

**i** Consult the technical datasheet LOTO-59 (104600) on [bradyeurope.com/tds](http://bradyeurope.com/tds)

**i** Consult the technical datasheet LOTO-60 (104601) on [bradyeurope.com/tds](http://bradyeurope.com/tds)

**i** Push button covers are warnings and tools to support lockout procedures but need to be part of a full lockout procedure to make sure no energy can be accidentally released during operations.

## Wall switch lockouts

Wall switch lockouts may be used with most wall-mounted switches.

- Easy to install using existing screws
- Locks switch in “on” or “off” position
- High visibility colour
- Service temperature from -20 °C to 80 °C
- 1 padlock can be applied

| Order Reference | Description         | Material      | Text/Legend            | Colour | Max. Switch Width (mm) | Quantity |
|-----------------|---------------------|---------------|------------------------|--------|------------------------|----------|
| 065392          | Wall Switch Lockout | Polypropylene | LOCKED ON / LOCKED OFF | Red    | 14.50                  | 1        |



## Fuse blockout devices

Comply with OSHA's Lockout/Tagout Standard by using High visibility red devices in conjunction with Brady Lockout Tags.

- Block out 6.0 mm to 17.5 mm and blade type fuses

| Order Reference | Description           | Notes / Details                            | Colour | Quantity |
|-----------------|-----------------------|--|--------|----------|
| 065690          | Fuse Blockout Devices | 6.35 mm, 7.14 mm, 10.32mm, 14.29 mm fuses. | Red    | 6        |
| 065691          | Fuse blockout devices | 20.64 mm, 26.99 mm and blade type fuses.   | Red    | 6        |



Consult the technical datasheet LOTO-49 on [bradyeurope.com/tds](http://bradyeurope.com/tds)

## AC sensors

AC sensor was selected by OSHA Electrical Technical Equipment Committee as the only instrument of its type for use by OSHA compliance officers to identify and cite electrical hazards of 50-1000 Volts.

- Simple to use and light-weight
- 2 AAA 1.5 V batteries are included
- CAT IV rated and UL Listed
- Not compliant in EU

| Order Reference | Description | Colour       | Quantity |
|-----------------|-------------|--------------|----------|
| 065269          | AC Sensor   | White on Red | 1        |



## BatteryBlock power connector lockout

Easy to use and applicable on a wide range of industrial vehicles, the BatteryBlock Power Connector Lockout is a great addition to your maintenance safety tool kit.

- The BatteryBlock Power Connector Lockout can be used to neutralise the energy flow of all vehicles powered by a battery with 175A to 350A connectors
- The device can effectively neutralise most forklifts, stackers, scissor lifts, pallet jacks and powered carts
- The lockout device has been designed as one piece to limit the loss of parts and further increase its usability.



| Order Reference | Description                          | Depth (mm) | Height (mm) | Width (mm) | Max. Shackle Diameter (mm) | Max number of padlocks applied | Additional Information                 | Quantity |
|-----------------|--------------------------------------|------------|-------------|------------|----------------------------|--------------------------------|--|----------|
| 150841          | BatteryBlock Power Connector Lockout | 63.50      | 66.62       | 79.00      | 7.87                       | 2                              | For use with 175A to 350A Plug Voltage | 1        |



## Confined space safety covers

Go beyond the basics with visual and lockable Confined Space Safety Covers to keep yourself covered and your crew safe. With this complete line of safety covers, you get coverage for most common confined space entrances.

- Provide a physical barrier and identification of confined spaces instead of signs and tapes that can be missed or ignored
- Restrict personnel access and prevent litter, debris and animals from getting in areas they shouldn't
- Get a complete offering that includes lockable options for added safety and vented options for areas with noxious gasses

| Order Reference | Text/Legend | Diameter (mm) | Attachment Type |
|-----------------|-------------|---------------|-----------------|
|-----------------|-------------|---------------|-----------------|

| Solid Lockable Covers |   |         |                  |
|-----------------------|---|---------|------------------|
| 151045                | Confined space. Enter by permit only.   | 1066.80 | Adjustable Strap |
| 151046                | Permit required. No unauthorized entry. | 1066.80 | Adjustable Strap |
| 151047                | Confined space. Enter by permit only.   | 1168.40 | Adjustable Strap |
| 151048                | Permit required. No unauthorized entry. | 1168.40 | Adjustable Strap |
| 151049                | Confined space. Enter by permit only.   | 1320.80 | Adjustable Strap |
| 151050                | Permit required. No unauthorized entry. | 1320.80 | Adjustable Strap |
| 151051                | Confined space. Enter by permit only.   | 1447.80 | Adjustable Strap |
| 151052                | Permit required. No unauthorized entry. | 1447.80 | Adjustable Strap |



| Ventilated Lockable Covers |  |  |  |
|----------------------------|--|--|--|
|----------------------------|--|--|--|

|        |   |         |                  |
|--------|---|---------|------------------|
| 151053 | Confined space. Enter by permit only.   | 1066.80 | Adjustable Strap |
| 151054 | Permit required. No unauthorized entry. | 1066.80 | Adjustable Strap |
| 151055 | Confined space. Enter by permit only.   | 1168.40 | Adjustable Strap |
| 151056 | Permit required. No unauthorized entry. | 1168.40 | Adjustable Strap |
| 151057 | Confined space. Enter by permit only.   | 1320.80 | Adjustable Strap |
| 151058 | Permit required. No unauthorized entry. | 1320.80 | Adjustable Strap |
| 151059 | Confined space. Enter by permit only.   | 1447.80 | Adjustable Strap |
| 151060 | Permit required. No unauthorized entry. | 1447.80 | Adjustable Strap |



| Red Mesh Lockable Covers |  |  |  |
|--------------------------|--|--|--|
|--------------------------|--|--|--|

|        |   |         |                  |
|--------|---|---------|------------------|
| 151079 | Confined space. Enter by permit only.   | 889.00  | Adjustable Strap |
| 151080 | Permit required. No unauthorized entry. | 889.00  | Adjustable Strap |
| 151081 | Confined space. Enter by permit only.   | 1041.40 | Adjustable Strap |
| 151082 | Permit required. No unauthorized entry. | 1041.40 | Adjustable Strap |
| 151083 | Confined space. Enter by permit only.   | 1244.60 | Adjustable Strap |
| 151084 | Permit required. No unauthorized entry. | 1244.60 | Adjustable Strap |
| 151085 | Confined space. Enter by permit only.   | 1473.20 | Adjustable Strap |
| 151086 | Permit required. No unauthorized entry. | 1473.20 | Adjustable Strap |



| Elastic Non-Lockable Covers |  |  |  |
|-----------------------------|--|--|--|
|-----------------------------|--|--|--|

|        |   |         |         |
|--------|---|---------|---------|
| 151061 | Confined space. Enter by permit only.   | 965.20  | Elastic |
| 151062 | Permit required. No unauthorized entry. | 965.20  | Elastic |
| 151063 | Confined space. Enter by permit only.   | 1092.20 | Elastic |
| 151064 | Permit required. No unauthorized entry. | 1092.20 | Elastic |
| 151065 | Confined space. Enter by permit only.   | 1346.20 | Elastic |
| 151066 | Permit required. No unauthorized entry. | 1346.20 | Elastic |
| 151067 | Confined space. Enter by permit only.   | 1498.60 | Elastic |
| 151068 | Permit required. No unauthorized entry. | 1498.60 | Elastic |



| Order Reference | Text/Legend | Diameter (mm) | Attachment Type |
|-----------------|-------------|---------------|-----------------|
|-----------------|-------------|---------------|-----------------|

| Magnetic Non-Lockable Covers |   |         |          |
|------------------------------|---|---------|----------|
| 151069                       | Confined space. Enter by permit only.   | 635.00  | Magnetic |
| 151070                       | Permit required. No unauthorized entry. | 635.00  | Magnetic |
| 151071                       | Confined space. Enter by permit only.   | 838.20  | Magnetic |
| 151072                       | Permit required. No unauthorized entry. | 838.20  | Magnetic |
| 151073                       | Confined space. Enter by permit only.   | 990.60  | Magnetic |
| 151074                       | Permit required. No unauthorized entry. | 990.60  | Magnetic |
| 151075                       | Confined space. Enter by permit only.   | 1143.00 | Magnetic |
| 151076                       | Permit required. No unauthorized entry. | 1143.00 | Magnetic |
| 151077                       | Confined space. Enter by permit only.   | 1397.00 | Magnetic |
| 151078                       | Permit required. No unauthorized entry. | 1397.00 | Magnetic |



| Order Reference | Text/Legend | Dimensions | Attachment Type |
|-----------------|-------------|------------|-----------------|
|-----------------|-------------|------------|-----------------|

| Tower Skirt Covers |   |                             |                  |
|--------------------|---|-----------------------------|------------------|
| 151095             | Confined space. Enter by permit only.   | 609.60 mm W x 609.60 mm H   | Adjustable Strap |
| 151096             | Permit required. No unauthorized entry. | 609.60 mm W x 609.60 mm H   | Adjustable Strap |
| 151097             | Confined space. Enter by permit only.   | 1016.00 mm W x 1016.00 mm H | Adjustable Strap |
| 151098             | Permit required. No unauthorized entry. | 1016.00 mm W x 1016.00 mm H | Adjustable Strap |
| 151099             | Confined space. Enter by permit only.   | 1219.20 mm W x 1219.20 mm H | Adjustable Strap |
| 151100             | Permit required. No unauthorized entry. | 1219.20 mm W x 1219.20 mm H | Adjustable Strap |
| 151101             | Confined space. Enter by permit only.   | 1270.00 mm W x 1270.00 mm H | Adjustable Strap |
| 151102             | Permit required. No unauthorized entry. | 1270.00 mm W x 1270.00 mm H | Adjustable Strap |



| Tower Skirt Lockable Covers Set |  |  |  |
|---------------------------------|--|--|--|
|---------------------------------|--|--|--|

|        |   |              |                  |
|--------|---|--------------|------------------|
| 151087 | Confined space. Enter by permit only.   | 609.60 mm H  | Adjustable Strap |
| 151088 | Permit required. No unauthorized entry. | 609.60 mm H  | Adjustable Strap |
| 151089 | Confined space. Enter by permit only.   | 1016.00 mm H | Adjustable Strap |
| 151090 | Permit required. No unauthorized entry. | 1016.00 mm H | Adjustable Strap |
| 151091 | Confined space. Enter by permit only.   | 1219.20 mm H | Adjustable Strap |
| 151092 | Permit required. No unauthorized entry. | 1219.20 mm H | Adjustable Strap |
| 151093 | Confined space. Enter by permit only.   | 1270.00 mm H | Adjustable Strap |
| 151094 | Permit required. No unauthorized entry. | 1270.00 mm H | Adjustable Strap |

| Ratchet Strap Lockable Set |  |  |  |
|----------------------------|--|--|--|
|----------------------------|--|--|--|

|        |   |                        |                  |
|--------|---|------------------------|------------------|
| 151103 | - | 50.80 mm W x 7.92 m L  | Adjustable Strap |
| 151104 | - | 50.80 mm W x 15.24 m L | Adjustable Strap |
| 151105 | - | 50.80 mm W x 19.81 m L | Adjustable Strap |
| 151106 | - | 50.80 mm W x 24.38 m L | Adjustable Strap |





# Hasps, kits, bags, stations, tags, labels and printers

## Hasps

- 64 Safety lockout
- 64 Stainless steel scissor action hasp
- 64 Stubby lockout
- 64 Economy lockout
- 65 Nylon lockout hasp
- 65 Dual safety hasps
- 65 Non-conductive lockout hasp
- 66 Labelled safety lockout hasp
- 66 Labelled group lockout hasps
- 66 Blank safety lockout hasp
- 66 Heavy duty steel lockout

## Lockout kits

- 67 Ultimate lockout kit
- 68 Electrical lockout kit
- 68 Electrician lockout kit
- 78 Valve and electrical lockout kit
- 69 Valve lockout kit
- 70 Small adjustable lockout kit
- 70 Lockout intro kit
- 70 Gate valve lockout kit
- 71 Mini lockout starter kit
- 71 Personal padlock kit
- 72 Lockout visit bag

## Lockout pouches & bags

- 72 Lockout satchel
- 73 Personal belt pouch
- 73 Lockout belt pouch
- 73 Large lockout pouch
- 73 Lockout duffel bag
- 73 Lockout tool boxes

## Lockout stations & boards

- 74 Industrial strength lockout station
- 74 Lock boards
- 74 Adjustable lockout stations
- 75 Lockout tagout shadow boards

## Tagout

- 76 Warning tags
- 77 Brady safety tags
- 77 Mini tags
- 77 Brady custom tags
- 78 Process tags
- 79 Photo tags
- 79 Machine related risk warning tags
- 79 RipTag™ safety tag roll
- 79 Re-writable lockout tags
- 80 Two-part perforated tags
- 80 Mini tags
- 80 Laminat™ tags
- 80 Blank utility tags
- 81 Tag holder
- 81 Safety tag station
- 81 Magnetic signs
- 81 Brady inspection timer
- 81 Coloured nylon ties
- 82 Energy source labels & tags
- 83 Sign and label printers





## Safety lockout

Allow six workers to lock out a single energy source!

- Vinyl Coated High Tensile Steel
- 6 padlocks can be applied
- Padlock holes diameter: 11 mm
- Hook edge dimensions: 2 mm x 6 mm



| Order Reference | Colour | Shackle Width (mm) | Max. Shackle Diameter (mm) | Min. Shackle Clearance (mm) | Additional Information   | Quantity |
|-----------------|--------|--------------------|----------------------------|-----------------------------|--|----------|
| 805840          | Red    | 25.00              | 9.50                       | 20.00                       | -  | 12       |
| 805842          | Yellow | 25.00              | 9.50                       | 20.00                       | -  | 12       |
| 805841          | Red    | 38.00              | 9.50                       | 20.00                       | -  | 12       |
| 805843          | Yellow | 38.00              | 9.50                       | 20.00                       | -  | 12       |
| 105718          | Red    | 25.00              | 9.50                       | 20.00                       | Tamperproof interlocking tabs to prevent unauthorised opening. | 1        |
| 105719          | Red    | 38.00              | 9.50                       | 20.00                       | Tamperproof interlocking tabs to prevent unauthorised opening. | 1        |



Consult the technical datasheet LOTO-64 on [bradyeurope.com/tds](http://bradyeurope.com/tds) for the lockouts with tabs



Consult the technical datasheet LOTO-66 on [bradyeurope.com/tds](http://bradyeurope.com/tds) for the other lockouts



## Stainless steel scissor action hasp

Designed to provide a maximum tamperproof locking facility

- Made from marine grade (316) stainless steel scissor hasps with a 28 mm diam jaw
- Small shackle size for 4 mm hasp holes
- 6 padlocks can be applied

| Order Reference | Colour | Max. Shackle Diameter (mm) | Additional Information | Quantity |
|-----------------|--------|----------------------------|------------------------|----------|
| 852440          | Silver | 10.00                      | 28.00 mm jaw diameter  | 1        |



## Stubby lockout

Lock out small switch boxes to large control units and levers with one device - no need for separate hasps of different sizes!

- Two-in-one hasp sizes: 31.75 x 44.45 and 19 mm diameter
- To be used when lockout conditions vary in size
- 6 padlocks can be applied

| Order Reference | Colour | Max. Shackle Diameter (mm) | Min. Shackle Clearance (mm) | Quantity |
|-----------------|--------|----------------------------|-----------------------------|----------|
| 236919          | Red    | 10.00                      | 20.00                       | 1        |



## Economy lockout

- Use on fuse or switch boxes
- Made from sturdy steel
- Hasp shackle diameter: 25.4 mm
- 6 padlocks can be applied

| Order Reference | Colour | Max. Shackle Diameter (mm) | Min. Shackle Clearance (mm) | Quantity |
|-----------------|--------|----------------------------|-----------------------------|----------|
| 236920          | Red    | 10.00                      | 20.00                       | 1        |

## Nylon lockout hasp

Locks out any piece of equipment safely and effectively.

- Non-conductive nylon hasps accommodates up to 6 locks
- Withstands up to 450 kg, yet weighs only 30 g
- Lockout Shackle fits in holes with a minimum diameter of 7 mm

| Order Reference | Colour | Max. Shackle Diameter (mm) | Min. Shackle Clearance (mm) | Quantity |
|-----------------|--------|----------------------------|-----------------------------|----------|
| 236916*         | Orange | 9.00                       | 20.00                       | 1        |

\*This product meets the ATEX Equipment Directive.



Consult the technical datasheet LOTO-35 on [bradyeurope.com/tds](http://bradyeurope.com/tds)



## Dual safety hasps

This lockout device enables a supervisory padlock (6 holes) or two supervisory padlocks (12 holes) to remain safely locked in place, ensuring that the machine remains isolated.

- Foolproof access to the hasp entry and a tamperproof locking facility add another degree of safety
- Made from marine grade stainless steel (316)
- The lockout device has a 5.00 mm shackle that will fit most electrical & switch gear cabinets and distribution boards
- Available in 6 holes x 1 supervisory, or 12 holes x 2 supervisory configurations

| Order Reference | Description                       | Colour | Shackle Width (mm) | Quantity |
|-----------------|-----------------------------------|--------|--------------------|----------|
| 873384          | Dual Level 12 Hole Safety Lockout | Red    | 35.00              | 1        |
| 852439          | Dual Level 6 Hole Safety Lockout  | Red    | 35.00              | 1        |



## Non-conductive lockout hasp

Offers high flexibility, resistance to cracking and most chemicals and has excellent electrical insulating characteristics!

- Made of strong, rigid red plastic resin
- Performs at low temperatures, excellent heat resistance
- Lockout Shackle fits in holes with a minimum diameter of 10 mm

| Order Reference | Description                 | Colour | Shackle Diameter (mm) | Max. Shackle Diameter (mm) | Min. Shackle Clearance (mm) | Quantity |
|-----------------|-----------------------------|--------|-----------------------|----------------------------|-----------------------------|----------|
| 045582          | Non-Conductive Lockout Hasp | Red    | 6.10                  | 9.00                       | 20.00                       | 1        |



## Labelled safety lockout hasp

Combination of lockout and tagout - one device for multi-task performance!

- A single employee can lock out and service equipment, and up to 5 additional employees can apply their locks and tags
- Tough 5052 anodised aluminium alloy
- Use pens, pencils and permanent markers
- Text from pens and pencils can be erased



| Order Reference | Text/Legend                | Colour | Max. Shackle Diameter (mm) | Min. Shackle Clearance (mm) | Height (mm) | Width (mm) | Depth (mm) | Quantity |
|-----------------|----------------------------|--------|----------------------------|-----------------------------|-------------|------------|------------|----------|
| 265390          | DO NOT OPERATE             | Red    | 8.00                       | 20.00                       | 184.10      | 76.20      | 4.70       | 5        |
| 265391          | NICHT SCHALTEN             | Red    | 8.00                       | 20.00                       | 184.10      | 76.20      | 4.70       | 5        |
| 265392          | NIET BEDIENEN              | Red    | 8.00                       | 20.00                       | 184.10      | 76.20      | 4.70       | 5        |
| 265393          | NE PAS FAIRE FONCTIONNER   | Red    | 8.00                       | 20.00                       | 184.10      | 76.20      | 4.70       | 5        |
| 811106          | NO PONER EN FUNCIONAMIENTO | Red    | 8.00                       | 20.00                       | 184.10      | 76.20      | 4.70       | 5        |

## Labelled group lockout hasps

Make sure your workers are safe by supplying labelled lockout hasps for all of their group lockout procedures.



- Constructed from tough 5052 anodised aluminium alloy
- Includes tamperproof locking tabs
- Write-on label surface accepts pencils, pen or marker
- Pen and pencil markings can be easily erased, allowing repeated use
- Combination pack contains 1 of each colour
- Legend on the front side: DANGER DO NOT OPERATE
- Lock holes 8 mm
- 6 padlocks can be applied

| Order Reference                                | Colour                                 | Height (mm) | Width (mm) | Depth (mm) | Quantity |
|--|--|-------------|------------|------------|----------|
| DANGER This energy source has been LOCKED OUT. |  |             |            |            |          |
| 065960   | Red                                    | 180.00      | 76.00      | 5.00       | 5        |
| 065961   | Silver                                 | 180.00      | 76.00      | 5.00       | 5        |
| 065962   | Blue                                   | 180.00      | 76.00      | 5.00       | 5        |
| 065963   | Green                                  | 180.00      | 76.00      | 5.00       | 5        |
| 065964   | Gold                                   | 180.00      | 76.00      | 5.00       | 5        |
| 065967   | 1 each Red, Silver, Blue, Green & Gold | 180.00      | 76.00      | 5.00       | 5        |

| Order Reference   | Colour                                 | Height (mm) | Width (mm) | Depth (mm) | Quantity |
|---|--|-------------|------------|------------|----------|
| DANGER Only the individual(s) who have signed below may remove this lock/tag. |  |             |            |            |          |
| 065970  | Red                                    | 180.00      | 76.00      | 5.00       | 5        |
| 065971  | Silver                                 | 180.00      | 76.00      | 5.00       | 5        |
| 065972  | Blue                                   | 180.00      | 76.00      | 5.00       | 5        |
| 065973  | Green                                  | 180.00      | 76.00      | 5.00       | 5        |
| 065974  | Gold                                   | 180.00      | 76.00      | 5.00       | 5        |
| 065975  | 1 each Red, Silver, Blue, Green & Gold | 180.00      | 76.00      | 5.00       | 5        |



## Blank safety lockout hasp

- Made from aluminium
- Available in several colours
- 6 padlocks can be applied

Remember you can easily customise blank hasps with Brady labels.

| Order Reference | Colour | Max. Shackle Diameter (mm) | Min. Shackle Clearance (mm) | Height (mm) | Width (mm) | Depth (mm) | Quantity |
|-----------------|--------|----------------------------|-----------------------------|-------------|------------|------------|----------|
| 225196          | Silver | 8.00                       | 20.00                       | 184.10      | 76.20      | 4.70       | 5        |
| 225198          | Green  | 8.00                       | 20.00                       | 184.10      | 76.20      | 4.70       | 5        |
| 265399          | Red    | 8.00                       | 20.00                       | 184.10      | 76.20      | 4.70       | 5        |



## Heavy duty steel lockout

Tamper-proof design which prevents vandalism

- Solid U-shape steel bolt cannot be pried apart once locks are in place
- Holds up to 3 locks
- Inside diameter of U-shape bolt is 25.4 mm

| Order Reference | Description                          | Max. Shackle Diameter (mm) | Min. Shackle Clearance (mm) | Quantity |
|-----------------|--------------------------------------|----------------------------|-----------------------------|----------|
| 230000          | Heavy Duty Steel Hasp + 150 mm chain | 9.00                       | 20.00                       | 1        |
| 236918          | Heavy Duty Steel Hasp                | 9.00                       | 20.00                       | 1        |



Consult the technical datasheet LOTO-69 on [bradyeurope.com/tds](http://bradyeurope.com/tds)



Brady offers a range of well-equipped lockout tagout kits. The kits are designed to help workers to establish an effective and safe lockout programme and to help them comply with company lockout procedures and health and safety regulations. The range consists of several different lockout tagout kits, where each kit has been designed with a different need in mind.

**Remember - an effective lockout procedure saves time, saves money and saves lives!**

## Ultimate lockout kit

This is our most extensive lockout/tagout kit and includes everything a larger company might need for their lockout/tagout programme as well as training material.



| Order Reference | Description          | Quantity |
|-----------------|----------------------|----------|
| 806178          | Ultimate Lockout Kit | 1        |

### Content

| Order Reference | Description  | Quantity/Kit |
|-----------------|--|--------------|
| 833918          | Lockout / Tagout – Global Best Practice Training Movie. Reduce work accidents! | 1            |
| 050899          | Large Universal Valve Lockout Base Clamping Unit                               | 1            |
| 065403          | Large Blocking Arm   | 1            |
| 051395          | Cable attachment with 2.44 metre sheathed cable. Cable diameter 3.25 mm        | 1            |
| 064057          | Adjustable Gate Valve Lockout  | 1            |
| 050943          | All Purpose Cable Lockout with Vinyl Coated Metal Cable - 2.44 m               | 1            |
| 065675          | Lockout Devices for Plug Connections - Large                                   | 1            |
| 256960          | Butterfly Valve Lockout  | 1            |
| 046139          | Cylinder Tank Lockout  | 1            |
| 045629          | Gas Cylinder Lockout   | 1            |
| 050940          | Mini Cable Lockout with steel cable  | 1            |
| 065396          | No Hole Circuit Breaker Lockout - 277 Volt Device                              | 1            |
| 065397          | No Hole Circuit Breaker Lockout - 480-600 Volts Device                         | 1            |
| 090891          | 480-600V Breaker Lockout Kit*  | 1            |
| 149433          | Miniature Circuit Breaker - Pin-out Wide (ABB-MS325)                           | 1            |
| 149514          | Universal Mini Circuit Breaker Lockout   | 1            |
| 805853          | Miniature Breaker Lockout Demo Kit   | 1            |
| 805814          | Economy Multi-Pole Breaker Lockout   | 1            |

| Order Reference | Description  | Quantity/Kit |
|-----------------|--|--------------|
| 236916          | Nylon Lockout Hasp   | 1            |
| 051339          | Safety Padlocks - Standard   | 6            |
| 805840          | Safety Lockout   | 12           |
| 099162          | Lockout Duffel Bag   | 1            |
| 256565          | Tag: "DO NOT OPERATE - Maintenance Department This Lock/Tag may only be removed by:" 75 x 160 mm | 10           |
| 050979          | Large Lockout Pouch  | 1            |
| 051172          | Lockout Belt Pouch   | 1            |
| 087052          | Permanent Marker - Fine  | 1            |

**BRADY**  
Customise-it

Interested in custom kits tailored to your needs? Contact your Brady distributor or our customer service.

## Electrical lockout kit

Our electrical lockout kit gives you all the basics to lock out breakers, electrical plugs, wall switches and fuses.



| Order Reference | Description            | Quantity |
|-----------------|------------------------|----------|
| 805909          | Electrical Lockout Kit | 1        |

### Content

| Order Reference | Description   | Quantity/Kit |
|-----------------|---|--------------|
| 066321          | Universal Multi-Pole Breaker Lockout  | 1            |
| 065396          | No Hole Circuit Breaker Lockout - 277 Volt Device   | 1            |
| 065404          | Extra Cleats for 120/277V Lockout   | 6            |
| 065397          | No Hole Circuit Breaker Lockout - 480-600 Volts Device  | 1            |
| 065406          | Extra Cleats for 480/600V Lockout   | 6            |
| 149433          | Miniature Circuit Breaker - Pin-out Wide (ABB-MS325)  | 1            |
| 149514          | Universal Mini Circuit Breaker Lockout  | 1            |
| 805853          | Miniature Breaker Lockout Demo Kit  | 1            |
| 051339          | Safety Padlocks - Standard  | 2            |
| 236916          | Nylon Lockout Hasp  | 1            |
| 045582          | Non-Conductive Lockout Hasp   | 1            |
| 050979          | Large Lockout Pouch   | 1            |
| 256566          | Tag: "DO NOT OPERATE Electrician At Work - This Lock/Tag may only be removed by:" 75 x 160 mm | 10           |
| 087052          | Permanent Marker - Fine   | 1            |

## Electrician lockout kit

Most popular circuit breaker lockout devices allowing to lock a wide range of circuit breakers



### Electrician Lockout Kit (196217) includes:

1 x 090847 - Miniature Circuit Breaker Lockout Pin-In-Standard (PIS), 1 x 090844 - Miniature Circuit Breaker Lockout Pin-Out-Standard (POS), 1 x 090850 - Miniature Circuit Breaker Lockout Pin-Out-Wide (POW), 1 x 090853 - Miniature Circuit Breaker Lockout Tie Bar (TBLO), 1 x 149433 - Miniature Circuit Breaker - Pin-out Wide (ABB-MS325), 1 x 149514 - Universal Mini Circuit Breaker Lockout, 1 x 065396 - No Hole Circuit Breaker 277V, 1 x 065397 - No Hole Circuit Breaker 480-600V, 1 x 800112 - Cable Lockout Device, 1 x 236916 - Nylon Lockout Hasp, 1 x 050979 Large Lockout Pouch, 1 x 087052 - Pen

- The basic kit can be combined with any padlock sets, already available or to be ordered (allowing any key chart)
- The kit also exists with 2 red full nylon padlocks, ideal for electrical applications and to be used with these lockout devices
- As best practice, it's always advised to place a tag when a lockout device is placed to inform other workers. New Mini tags have been developed for this application. (dimensions: 100 x 25 mm, 50 tags / pack)
- Mini tags available in 9 languages

| Order Reference                | Description                                 |
|--------------------------------|---|
| <b>Base kit</b>                |   |
| 196217                         | Electrician Lockout Kit                     |
| <b>Kit with padlocks</b>       |   |
| 196227                         | Electrician Lockout Kit + Padlocks          |
| <b>Kit with tags</b>           |   |
| 196221                         | Electrician Lockout Kit + Tag DE            |
| 196218                         | Electrician Lockout Kit + Tag EN            |
| 196224                         | Electrician Lockout Kit + Tag ES            |
| 196219                         | Electrician Lockout Kit + Tag FR            |
| 196223                         | Electrician Lockout Kit + Tag HU            |
| 196222                         | Electrician Lockout Kit + Tag IT            |
| 196220                         | Electrician Lockout Kit + Tag NL            |
| 196225                         | Electrician Lockout Kit + Tag RO            |
| 196226                         | Electrician Lockout Kit + Tag TK            |
| <b>Kit with locks and tags</b> |   |
| 196231                         | Electrician Lockout Kit + Padlocks & Tag DE |
| 196228                         | Electrician Lockout Kit + Padlocks & Tag EN |
| 196234                         | Electrician Lockout Kit + Padlocks & Tag ES |
| 196229                         | Electrician Lockout Kit + Padlocks & Tag FR |
| 196233                         | Electrician Lockout Kit + Padlocks & Tag HU |
| 196232                         | Electrician Lockout Kit + Padlocks & Tag IT |
| 196230                         | Electrician Lockout Kit + Padlocks & Tag NL |
| 196235                         | Electrician Lockout Kit + Padlocks & Tag RO |
| 196236                         | Electrician Lockout Kit + Padlocks & Tag TK |

## Valve and electrical lockout kit

Our combination lockout kit gives you everything you need to lock out the most common mechanical and electrical control points.

| Order Reference | Description                      | Quantity |
|-----------------|----------------------------------|----------|
| 806174          | Valve and Electrical Lockout Kit | 1        |

### Content

| Order Reference | Description  | Quantity/Kit |
|-----------------|--|--------------|
| 050899          | Large Universal Valve Lockout Base Clamping Unit   | 1            |
| 065403          | Large Blocking Arm   | 1            |
| 051395          | Cable attachment with 2.44 metre sheathed cable.<br>Cable diameter 3.25 mm                             | 1            |
| 064057          | Adjustable Gate Valve Lockout  | 1            |
| 050943          | All Purpose Cable Lockout with Vinyl Coated Metal Cable - 2.44 m                                       | 1            |
| 065675          | Lockout Devices for Plug Connections - Large   | 1            |
| 065396          | No Hole Circuit Breaker Lockout - 277 Volt Device  | 1            |
| 065397          | No Hole Circuit Breaker Lockout - 480-600 Volts Device   | 1            |
| 090891          | 480-600V Breaker Lockout Kit   | 1            |
| 805853          | Miniature Breaker Lockout Demo Kit   | 1            |
| 236916          | Nylon Lockout Hasp   | 1            |
| 051339          | Safety Padlocks - Standard   | 6            |
| 805840          | Safety Lockout   | 12           |
| 099162          | Lockout Duffel Bag   | 1            |
| 256565          | Tag: "DO NOT OPERATE - Maintenance Department<br>This Lock/Tag may only be removed by:"<br>75 x 160 mm | 10           |
| 087052          | Permanent Marker - Fine  | 1            |



## Valve lockout kit

| Order Reference | Description       | Quantity |
|-----------------|-------------------|----------|
| 806175          | Valve Lockout Kit | 1        |

### Content

| Order Reference | Description  | Quantity/Kit |
|-----------------|--|--------------|
| 050899          | Large Universal Valve Lockout Base Clamping Unit   | 1            |
| 065403          | Large Blocking Arm   | 1            |
| 051395          | Cable attachment with 2.44 metre sheathed cable.<br>Cable diameter 3.25 mm                             | 1            |
| 064057          | Adjustable Gate Valve Lockout  | 1            |
| 050943          | All Purpose Cable Lockout with Vinyl Coated Metal Cable - 2.44 m                                       | 1            |
| 051339          | Safety Padlocks - Standard   | 6            |
| 805840          | Safety Lockout   | 12           |
| 256565          | Tag: "DO NOT OPERATE - Maintenance Department<br>This Lock/Tag may only be removed by:"<br>75 x 160 mm | 10           |
| 806200          | Lockout Satchel  | 1            |
| 087052          | Permanent Marker - Fine  | 1            |





## Small adjustable lockout kit

Our valve lockout kit gives you everything you need to lock out gate, ball, butterfly and other valves

| Order Reference | Description                  | Quantity |
|-----------------|------------------------------|----------|
| 806176          | Small Adjustable Lockout Kit | 1        |

### Content

| Order Reference | Description   | Quantity/Kit |
|-----------------|---|--------------|
| 064057          | Adjustable Gate Valve Lockout   | 1            |
| 050943          | All Purpose Cable Lockout with Vinyl Coated Metal Cable - 2.44 m                                    | 1            |
| 051339          | Safety Padlocks - Standard  | 2            |
| 805840          | Safety Lockout  | 2            |
| 050924          | Small Universal Valve Lockout Base Clamping Unit  | 1            |
| 065402          | Small Blocking Arm  | 1            |
| 256565          | Tag: "DO NOT OPERATE - Maintenance Department This Lock/Tag may only be removed by:"<br>75 x 160 mm | 10           |
| 050979          | Large Lockout Pouch   | 1            |
| 087052          | Permanent Marker - Fine   | 1            |



## Lockout intro kit

Our Lockout Intro kit gives you everything you need to get started in locking out most common mechanical risks.

| Order Reference | Description       | Quantity |
|-----------------|-------------------|----------|
| 805877          | Lockout Intro Kit | 1        |

### Content

| Order Reference | Description  | Quantity/Kit |
|-----------------|--|--------------|
| 050924          | Small Universal Valve Lockout Base Clamping Unit                           | 1            |
| 065402          | Small Blocking Arm   | 1            |
| 051395          | Cable attachment with 2.44 metre sheathed cable.<br>Cable diameter 3.25 mm | 1            |
| 050943          | All Purpose Cable Lockout with Vinyl Coated Metal Cable - 2.44 m           | 1            |
| 051339          | Safety Padlocks - Standard   | 2            |
| 050979          | Large Lockout Pouch  | 1            |
| 262950          | Tag: "This Lock/Tag may only be removed by:"<br>75 x 160 mm                | 10           |
| 087052          | Permanent Marker - Fine  | 1            |



## Gate valve lockout kit

Our gate valve lockout satchel kit includes five sizes of gate valve lockouts in a handy red satchel with a shoulder strap

| Order Reference | Description            | Quantity |
|-----------------|------------------------|----------|
| 806177          | Gate Valve Lockout Kit | 1        |

### Content

| Order Reference | Description   | Quantity/Kit |
|-----------------|---|--------------|
| 065560          | 25-64 mm red Gate Valve Lockout   | 1            |
| 065561          | 64-127 mm red Gate Valve Lockout  | 1            |
| 065562          | 127-165 mm red Gate Valve Lockout   | 1            |
| 065563          | 165-254 mm red Gate Valve Lockout   | 1            |
| 065564          | 254-330 mm red Gate Valve Lockout   | 1            |
| 051339          | Safety Padlocks - Standard  | 6            |
| 256565          | Tag: "DO NOT OPERATE - Maintenance Department This Lock/Tag may only be removed by:"<br>75 x 160 mm | 10           |
| 806200          | Lockout Satchel   | 1            |
| 087052          | Permanent Marker - Fine   | 1            |

## Safety lock & tag carrier kits

The Safety Lock & Tag Carrier is designed to hold up to 12 safety padlocks and keys, as well as lockout hasps and procedure tags.

Kits include:

- Red carrier (with two small and one large carabineer, coiled key strap for holding, product labels (English, Spanish and French) and three lockout procedure tags (English only))
- Two safety hasps
- Twelve padlocks with different keyed options available:
  - Six red keyed alike and six yellow keyed alike locks
  - Three keyed alike locks of each colour: red, yellow, blue, green
  - Twelve red keyed different locks



| Order Reference | Description  | Width (mm) | Height (mm) | Quantity |
|-----------------|--|------------|-------------|----------|
| 148867          | Safety Lock and Tag Carrier With 12 Keyed Different Safety Padlocks      | 190.50     | 133.35      | 1 Kit    |
| 148864          | Safety Lock and Tag Carrier With 2 Sets of 6 Keyed Alike Safety Padlocks | 190.50     | 133.35      | 1 Kit    |
| 148869          | Safety Lock and Tag Carrier With 4 Sets of 3 Keyed Alike Safety Padlocks | 190.50     | 133.35      | 1 Kit    |

## Gate valve lockout set

All sizes in one set to have a device for gate valves from 25 mm to 330 mm

| Order Reference | Description                          | Colour      | Quantity |
|-----------------|--------------------------------------|-------------|----------|
| 196213          | Gate Valve Lockout Set - Blue        | Blue        | 5        |
| 196215          | Gate Valve Lockout Set - Green       | Green       | 5        |
| 196212          | Gate Valve Lockout Set - Red         | Red         | 5        |
| 196216          | Gate Valve Lockout Set - Transparent | Transparent | 5        |
| 196214          | Gate Valve Lockout Set - Yellow      | Yellow      | 5        |



## Mini lockout starter kit

An economical kit which will allow you to lockout a variety of equipment.

| Order Reference | Description              | Quantity |
|-----------------|--------------------------|----------|
| 805856          | Mini Lockout Starter Kit | 1        |

### Content

| Order Reference | Description                                  | Quantity/Kit |
|-----------------|--|--------------|
| 805840          | Safety Lockout - 25 mm - red                 | 1            |
| 805842          | Safety Lockout - 25 mm - yellow              | 1            |
| 805841          | Safety Lockout - 38 mm - red                 | 1            |
| 805843          | Safety Lockout - 38 mm - yellow              | 1            |
| 051339          | Safety Padlocks - 38 mm - one of each colour | 6            |
| 236916          | Nylon Lockout Hasp                           | 1            |



## Personal padlock kit

Convenient way to carry padlocks (2 in kit), hasps and keys.

- The pouch has a clear plastic face to display identification
- The heavy duty retractable key holder features a Kevlar cord with split ring attachment, and is extendable to 1200 mm
- Key holder can be attached to the pouch or can be used on its own!

| Order Reference | Description          | Quantity |
|-----------------|----------------------|----------|
| 873872          | Personal Padlock Kit | 1        |

### Content

| Order Reference | Description                       | Quantity/Kit |
|-----------------|-----------------------------------|--------------|
| 873871          | Personal belt pouch (pouch only)  | 1            |
| 874074          | Heavy duty retractable Key holder | 1            |
| 805840          | Safety Hasp - 25 mm - red         | 1            |
| 051339          | Safety Padlocks - 38 mm - red     | 2            |







## Lockout visit bag

The lockout/tagout visit bag has several pockets to store and smoothly retrieve any lockout/tagout product.

- Some of the bigger pockets are excellent storage compartments for the larger gate valve lockout device, the universal lockout device and similar size products.
- A small, complimentary bag to store accessories and small devices accompanies the lockout/tagout Visit Bag. All padlocks & keys, hasps or circuit breakers go into the small bag. Once you open it, you'll immediately have a clear overview of its contents.
- The small bag fits perfectly in one of the big bag's pockets and can be used as a standalone or in combination with the lockout/tagout Visit Bag.

| Order Reference | Description                          | Height (mm) | Width (mm) | Depth (mm) | Quantity |
|-----------------|--------------------------------------|-------------|------------|------------|----------|
| 830931          | LOTO Visit Bag - Large Bag Empty     | 330.00      | 450.00     | 200.00     | 1        |
| 830932          | LOTO Visit Bag - Large Bag Filled    | 330.00      | 450.00     | 200.00     | 1        |
| 830933          | LOTO Visit Bag - Small Bag Empty     | 320.00      | 420.00     | 45.00      | 1        |
| 830934          | LOTO Visit Bag - Small Bag Filled    | 320.00      | 420.00     | 45.00      | 1        |
| 830935          | LOTO Visit Bag - Complete Filled Bag | 330.00      | 450.00     | 200.00     | 1        |

\*Complete Filled Bag = Large Bag Filled + Small Bag Filled



Note that the filled bags contain 1 unit of each reference mentioned below. Replacements can only be acquired by ordering standard product packages. The references indicated in this document are the standard references from the pricelist.



### Content Big Bag

| Order Reference | Description  |
|-----------------|--|
| 050943          | All Purpose Cable Lockout with Vinyl Coated Metal Cable - 2.44 m           |
| 065562          | Brady Gate Valve Lockouts  |
| 051395          | Cable attachment with 2.44 metre sheathed cable.<br>Cable diameter 3.25 mm |
| 065403          | Large Blocking Arm   |
| 050899          | Large Universal Valve Lockout Base Clamping Unit                           |
| 050940          | Mini Cable Lockout with steel cable  |
| 225340          | Non-Conductive Ball Valve Lockout  |
| 225206          | Operating Tool   |
| 800110          | Prinzing Ball Valve Lockout  |
| 225203          | Pro-Lock + Cable - 1.5 m   |

### Content Small Bag

| Order Reference | Description   |
|-----------------|---|
| 090891          | 480-600V Breaker Lockout Kit*                         |
| 814073          | Aluminium padlocks - Aluminium Shackle                |
| 241719          | Brady Safety Tags                                     |
| 051354          | Brass Padlocks  |
| 065404          | Extra Cleats for 120/277V Lockout                     |
| 814097          | Laminated Steel Padlocks - Key retaining              |
| 090847          | Miniature Circuit Breaker Lockouts - Pin-In Standard  |
| 090844          | Miniature Circuit Breaker Lockouts - Pin-Out Standard |
| 090850          | Miniature Circuit Breaker Lockouts - Pin-Out Wide     |
| 090853          | Miniature Circuit Breaker Lockouts - Tie-Bar          |
| 149433          | Miniature Circuit Breaker - Pin-out Wide (ABB-MS325)  |
| 065396          | No Hole Circuit Breaker Lockout - 277 Volt Device     |
| 236916          | Nylon Lockout Hasp                                    |
| 065329          | Oversized 480-600 Breaker Lockout Device              |
| 805840          | Safety Lockout  |
| 814116          | Safety Padlocks - Compact                             |
| 814126          | Safety Padlocks - Compact                             |
| 814136          | Safety Padlocks - Compact                             |
| 814146          | Safety Padlocks - Compact                             |
| 813594          | Safety Padlocks - Nylon Shackle                       |
| 051339          | Safety Padlocks - Standard                            |
| 236919          | Stubby Lockout Hasp                                   |
| 265549          | Tagout: Warning Tags                                  |
| 149514          | Universal Mini Circuit Breaker Lockout                |
| 066321          | Universal Multi-Pole Breaker Lockout                  |



## Lockout satchel

- Made of 1000 denier red cordura nylon with a 95 cm shoulder strap (supplied empty)
- Includes latchable front pocket and two side mesh holders

| Order Reference | Description     | Height (mm) | Width (mm) | Depth (mm) | Quantity |
|-----------------|-----------------|-------------|------------|------------|----------|
| 806200          | Lockout Satchel | 355.00      | 380.00     | 100.00     | 1        |

## Personal belt pouch

A convenient way to carry padlocks, hasps and keys in a handy pouch. This is an empty pouch, allowing you to fill with content of your choice.

- The pouch has a clear plastic face to display identification

| Order Reference | Description                      | Quantity |
|-----------------|----------------------------------|----------|
| 873871          | Personal belt pouch (pouch only) | 1        |



## Lockout belt pouch

Simply fill the pouch with the lockout devices you need and have them handy when they are required.

- Made of heavy duty nylon with loops for hanging on a belt

| Order Reference | Description        | Height (mm) | Width (mm) | Depth (mm) | Quantity |
|-----------------|--------------------|-------------|------------|------------|----------|
| 051172          | Lockout Belt Pouch | 120.00      | 190.00     | 50.00      | 1        |

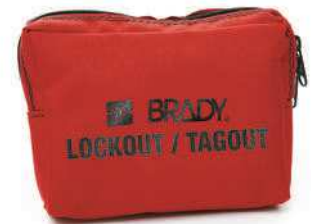

## Large lockout pouch

Create your own custom lockout kit and use the pouch to store it neatly.

- Made of nylon with attachment loop on back

| Order Reference | Description         | Height (mm) | Width (mm) | Depth (mm) | Quantity |
|-----------------|---------------------|-------------|------------|------------|----------|
| 050979          | Large Lockout Pouch | 203.00      | 178.00     | 76.00      | 1        |



## Lockout duffel bag

- Made of 600 denier polyester with a 95 cm removable shoulder strap and 8 inside pockets (supplied empty)

| Order Reference | Description        | Height (mm) | Width (mm) | Depth (mm) | Quantity |
|-----------------|--------------------|-------------|------------|------------|----------|
| 099162          | Lockout Duffel Bag | 215.00      | 420.00     | 125.00     | 1        |



## Lockout tool boxes

- Made of rugged polypropylene with nickel-plated steel clasps (supplied empty)
- Supplied with removeable tray and two handy storage pockets built into the lid

| Order Reference | Description            | Height (mm) | Width (mm) | Depth (mm) | Quantity |
|-----------------|------------------------|-------------|------------|------------|----------|
| 105906          | Medium Lockout Toolbox | 198.12      | 411.48     | 185.42     | 1        |
| 105905          | Small Lockout Toolbox  | 180.34      | 355.60     | 139.70     | 1        |



# Lockout stations & boards



## Industrial strength lockout station

- Lockable all metal, yellow powder-coated cabinet (supplied empty)
- Lockout safety tips on inside of door
- Can hold a wide variety of lockout devices
- Can be wall mounted or easily transported

| Order Reference | Description  | Height (mm) | Width (mm) | Depth (mm) | Quantity |
|-----------------|--|-------------|------------|------------|----------|
| 800123          | Industrial Strength Lockout Station                    | 406.00      | 355.00     | 152.00     | 1        |
| 800129          | Industrial Strength Lockout Station - Additional Shelf | -           | -          | -          | 1        |

## Lock boards

Brady's high visibility lock boards make your locks, tags and lockouts easy to find and use. Built for the toughest conditions, these lock boards are made of durable plastic material.

The lock boards are available as boards only. No components are included.

| Order Reference | Description   | Material | Height (mm) | Width (mm) | Quantity |
|-----------------|---------------|----------|-------------|------------|----------|
| 050989          | 5-Lock Board  | Acrylic  | 292.00      | 393.00     | 1        |
| 050990          | 10-Lock Board | Acrylic  | 342.00      | 342.00     | 1        |
| 050991          | 20-Lock Board | Acrylic  | 597.00      | 292.00     | 1        |
| 050992          | 36-Lock Board | Acrylic  | 546.00      | 597.00     | 1        |



5-Lock Board



10-Lock Board



20-Lock Board



36-Lock Board

## Adjustable lockout stations

- Constructed of sturdy polystyrene with pre-drilled holes for easy wall mounting
- Pre-drilled pegboard-style holes for hooks
- Hooks can be arranged in a multitude of ways
- Available from portable to extra large sizes

The lockout stations are available as boards only. No components are included.

| Order Reference | Description   | Material      | Height (mm) | Width (mm) | Depth (mm) | Quantity |
|-----------------|---|---------------|-------------|------------|------------|----------|
| 050993          | Adjustable Lockout Stations - Extra-large Lockout Station | Polystyrene   | 762.00      | 635.00     | 133.00     | 1        |
| 050994          | Adjustable Lockout Stations - Large Lockout Station       | Polystyrene   | 660.00      | 495.00     | 127.00     | 1        |
| 050997          | Adjustable Lockout Stations - Small Lockout Station       | Polystyrene   | 591.00      | 311.00     | 97.00      | 1        |
| 811217          | Portable Lockout Station                                  | Polypropylene | 432.00      | 432.00     | 171.00     | 1        |



Adjustable Lockout Stations - Extra-large Lockout Station



Adjustable Lockout Stations - Large Lockout Station



Adjustable Lockout Stations - Small Lockout Station



Portable Lockout Station

## Improve productivity with durable, visually organised shadow boards

Strengthen your lockout tagout programme thanks to a dedicated shadow board. Display your devices, padlocks and documents to make them clearly visible and easy to choose for the users.

Effective visual management and real time communication is vital for safe control of work (CoW) and achieving objectives set by 5S and LEAN)

### Features & benefits

- Durable clear plexiglass (Sub-surface graphics) or laminated white foam PVC
- Clean, crisp protected graphics that will not scratch off from frequent tool use
- Perforated to place each necessary fixing
- Customised hole positions
- Fixings optional for mounting flexibility
- Assist control of permit to work



### How to order your LOTO shadow boards

You can create your own shadow board. Draw what you have in mind. Add padlocks, locking devices and accessories.

Choose the material, layout, border and corners for your shadow board. Finally, add your own text and logo.

As each board is unique, pricing will be on request, based on information provided to give a size estimation of the the board.

Please contact your Brady representative to get futher details.

### Draft example

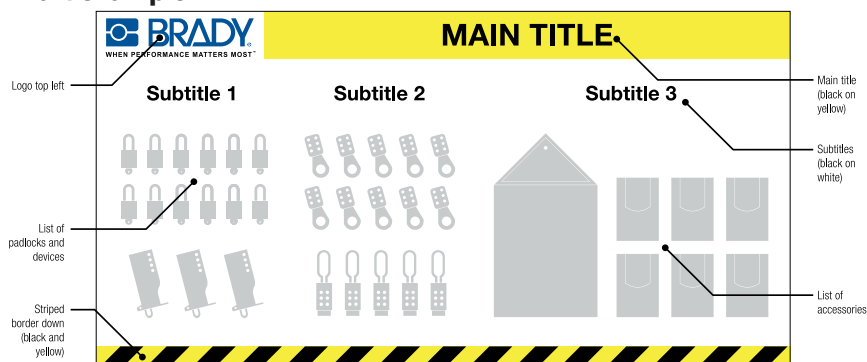

### Accessories

The following accessories are available as standard products.

| Order Reference | Description                                | Quantity | Colour                  |
|-----------------|--|----------|-------------------------|
| 110594          | Dry Erasable Marker Set                    | 4        | Black, Blue, Green, Red |
| 122000          | Magnetic Marker Holder                     | 1        | White                   |
| 196088          | Wall Display Rail - 1180mm                 | 1        | Grey                    |
| 196089          | Wall Display Rail - 880mm                  | 1        | Grey                    |
| 196191          | Wall Display Rail - 580mm                  | 1        | Grey                    |
| 196192          | Wall Display Rail - 310mm                  | 1        | Grey                    |
| 196193          | Wall Document Holder 1/3 A4                | 1        | Transparent             |
| 196194          | Wall Document holder A5                    | 1        | Transparent             |
| 196195          | Wall Document Holder A4 Portrait           | 1        | Transparent             |
| 196196          | Wall Document Dolder A4 Landscape          | 1        | Transparent             |
| 196197          | Magnetic Frame A4 Black/Yellow             | 2        | Black on Yellow         |
| 196198          | Magnetic Frame A4 Red/White                | 2        | Red/White               |
| 196199          | Magnetic Frame A4 Green/White              | 2        | Green/White             |
| 196200          | Magnetic Frame A4 Black                    | 2        | Black                   |
| 196201          | Magnetic Frame A4 Grey                     | 2        | Grey                    |
| 196202          | Magnetic Frame A4 Red                      | 2        | Red                     |
| 196203          | Magnetic Frame A4 Blue                     | 2        | Blue                    |
| 196204          | Magnetic Frame A4 Green                    | 2        | Green                   |
| 196205          | Magnetic Frame A4 Gold                     | 2        | Gold                    |
| 196206          | Magnetic Metallic Adhesive Tape 30mm x 10m | 1        | Black                   |
| 833760          | A4 Permit Wallets                          | 1        | Transparent             |
| 833761          | A5 Permit Wallets                          | 1        | Transparent             |



Wall Document Holder



Wall Display Rail



Magnetic Marker Holder  
(Magnetic Metallic Adhesive Tape is necessary to place the parker holder)



Magnetic Frame



Magnetic Metallic Adhesive Tape



Permit Wallet



Tagout is the placement of a tag, which indicates that the energy-isolating device and the equipment being controlled **MUST NOT** be operated until the tag has been removed.



## Warning tags

Indicate who is responsible for placing a Lockout device and who is authorised to remove it or make changes to it.

- Flexible polyester, resistant to water, oil and extreme temperatures
- Matt surface, can be written on with a ball point or felt-tip pen
- Hole diameter 7 mm, allows for placement on a padlock shackle
- Packaging: 10 tags with 10 cable ties

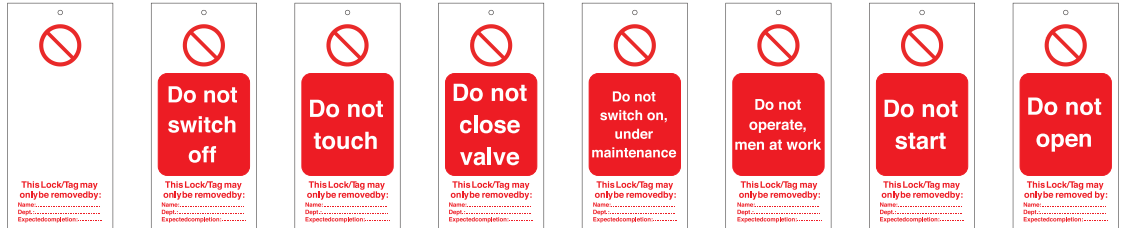

| Height (mm) | Width (mm) | Order Reference |        |        |        |        |        |        |        |
|-------------|------------|-----------------|--------|--------|--------|--------|--------|--------|--------|
| 110.00      | 50.00      | 225400          | 225401 | 225402 | 225403 | 225404 | 225405 | 225406 | 225408 |
| 160.00      | 75.00      | 262950          | 262951 | 262952 | 262953 | 262954 | 262957 | 265549 | 265550 |



| Height (mm) | Width (mm) | Order Reference |        |        |        |        |        |        |        |
|-------------|------------|-----------------|--------|--------|--------|--------|--------|--------|--------|
| 110.00      | 50.00      | 225409          | 225410 | 225411 | 225412 | 225407 | 225413 | 225414 | 225415 |
| 160.00      | 75.00      | 262962          | 262964 | 262965 | 256564 | 265548 | 256565 | 256566 | 256567 |

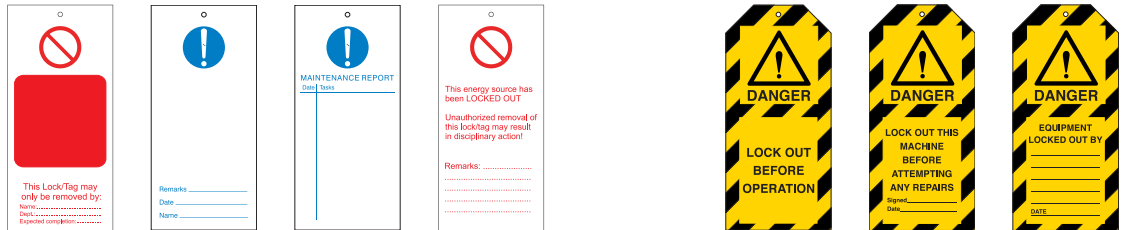

| Height (mm) | Width (mm) | Order Reference |        |        | Reverse | Order Reference |        |        |
|-------------|------------|-----------------|--------|--------|---------|-----------------|--------|--------|
| 110.00      | 50.00      | 225416          | 225418 | 225420 |         | 225421          | 225422 | 225423 |
| 160.00      | 75.00      | 256571          | 225417 | 225419 |         | 256572          | 256573 | 256575 |



**i** Do not forget to order a Permanent Marker Pen (087052)

| Height (mm) | Width (mm) | Order Reference |        |        |        | Reverse |
|-------------|------------|-----------------|--------|--------|--------|---------|
| 110.00      | 50.00      | 225424          | 225425 | 225426 | 225427 |         |
| 160.00      | 75.00      | 256576          | 256577 | 256578 | 256579 |         |

## Brady safety tags

Provide on-the-spot identification of safety measures!

- Easy application: can be attached in just seconds
- Tags have ties attached and can be applied to just about any part of any machine. No need for extra ties!
- The tag is printed on both sides, making sure the vital information is always visible
- Material: Heavy Duty Polyester 0.25 mm thickness
- Size of attachment tie: 15 x 140 mm. Label size: 85 x 145 mm
- Packaging: 10 tags



| Order Reference  | Order Reference                             | Order Reference                              | Order Reference                                     | Order Reference                                |
|--|---|--|---|--|
| <b>DANGER</b><br>241700                                | <b>DANGER Electric shock risk</b><br>241708 | <b>CAUTION Biohazard</b><br>241713           | <b>Do not switch on</b><br>241717                   | <b>FAILED ELECTRICAL SAFETY TEST</b><br>241720 |
| <b>CAUTION Out of Order</b><br>241701                  | <b>DANGER Live wire</b><br>241710           | <b>DANGER Radioactive material</b><br>241714 | <b>Do not switch on under maintenance</b><br>241718 | <b>TESTED FOR ELECTRICAL SAFETY</b><br>241721  |
| <b>CAUTION Men working on this equipment</b><br>241703 | <b>DANGER Contains asbestos</b><br>241712   | <b>Do not use out of order</b><br>241716     | <b>Do not touch</b><br>241719                       | <b>Reverse</b>                                 |

## Mini tags

| Order Reference | Legend  | Height (mm) | Width (mm) | Quantity |
|-----------------|---|-------------|------------|----------|
| 196086          | Do not operate                                  | 25.00       | 100.00     | 50       |
| 196087          | Warning Electricity                             | 25.00       | 100.00     | 50       |
| 196237          | Défense d'enclencher                            | 25.00       | 100.00     | 50       |
| 196238          | Niet bedienen                                   | 25.00       | 100.00     | 50       |
| 196239          | Nicht schalten                                  | 25.00       | 100.00     | 50       |
| 196240          | Non utilizzare                                  | 25.00       | 100.00     | 50       |
| 196241          | Üzemen kıvül                                    | 25.00       | 100.00     | 50       |
| 196242          | No operar                                       | 25.00       | 100.00     | 50       |
| 196243          | Nu folositi                                     | 25.00       | 100.00     | 50       |
| 196244          | Çalıştırmayın                                   | 25.00       | 100.00     | 50       |
| 196245          | Danger Electricité                              | 25.00       | 100.00     | 50       |
| 196246          | Waarschuwing: Gevaarlijke elektrische spanning  | 25.00       | 100.00     | 50       |
| 196247          | Warnung vor gefährlicher, elektrischer Spannung | 25.00       | 100.00     | 50       |

## Brady custom tags

To produce your custom tag(s), Brady requires the following information for each type/design of the tag you need:

1. Select from the 3 basic types of tags: General Warning, Electrical Warning, Prohibition (see sample previews below)
2. Select the size (110 x 50 mm or 160 x 75 mm)
3. Indicate quantity of packs (1 pack consists of 10 pcs of tags and 10 pcs of cable ties)
4. Define your text for the box in the central area of the tag

**BRADY**  
Customise-it

|                 |                    |             |
|-----------------|--------------------|-------------|
|                 |                    |             |
| General Warning | Electrical Warning | Prohibition |

Send your request for quotation containing all information listed above to your Brady representative or distributor

## Process tags

Easily communicate work equipment process management and control using highly practical and eye-catching colour-coded tags.

- Visualise management and control of work equipment processes
- Applications include cylinders and tanks, equipment, leaks and contamination, hoses and valves
- Share important safety information where it matters
- Reliable, chemical resistant, and easy to apply with cable ties
- Material: 0.5mm polypropylene.



Customised versions available on request

| Order Reference   | Height (mm) | Width (mm) |
|---|-------------|------------|
| GAS CYLINDER, EMPTY, IN USE, FULL<br>306718   | 150.00      | 80.00      |
| CARBON DIOXIDE CYLINDER, EMPTY, IN USE, FULL<br>306719  | 150.00      | 80.00      |
| ACETYLENE CYLINDER, EMPTY, IN USE, FULL<br>306720   | 150.00      | 80.00      |
| ARGON CYLINDER, EMPTY, IN USE, FULL<br>306721   | 150.00      | 80.00      |
| PROPANE CYLINDER, EMPTY, IN USE, FULL<br>306722   | 150.00      | 80.00      |
| OXYGEN CYLINDER, EMPTY, IN USE, FULL<br>306723  | 150.00      | 80.00      |
| TANK TAG, EMPTY, IN USE, FULL<br>306724   | 150.00      | 80.00      |
| OVERHAUL COMPLETED, READY FOR OVERHAUL, AWAITING CUSTOMER APPROVAL, AWAITING INSPECTION<br>306725 | 150.00      | 80.00      |
| PASSED INSPECTION<br>306726   | 150.00      | 80.00      |
| FAILED INSPECTION<br>306727   | 150.00      | 80.00      |
| HOLD<br>306728  | 150.00      | 80.00      |
| QUARANTINE<br>306729  | 150.00      | 80.00      |
| ACCEPTED<br>306730  | 150.00      | 80.00      |
| READY FOR HIRE<br>306733  | 150.00      | 80.00      |
| DO NOT HIRE<br>306734   | 150.00      | 80.00      |

| Order Reference   | Height (mm) | Width (mm) |
|---|-------------|------------|
| CLIENT OWNED EQUIPMENT<br>306735  | 150.00      | 80.00      |
| OFF RENTAL<br>306736  | 150.00      | 80.00      |
| JOINT BROKEN AWARE, JOINT BORKEN AWARE, RETURN TO SUPERVISOR<br>306738                                    | 176.00      | 80.00      |
| BREAKING OF EQUIPMENT<br>306739   | 176.00      | 80.00      |
| WITNESS JOINT<br>306740   | 176.00      | 80.00      |
| 306741  | 176.00      | 80.00      |
| DISTURBED JOINT, DISTURBED JOINT, LAST TEST<br>306742   | 200.00      | 80.00      |
| LEAK AWARE<br>306743  | 150.00      | 80.00      |
| WEEP AWARE<br>306744  | 150.00      | 80.00      |
| FREON LEAK AWARE<br>306745  | 150.00      | 80.00      |
| APPROVED TEMPORARY EQUIPMENT<br>306749  | 150.00      | 80.00      |
| TEMPORARY EQUIPMENT TAG, BACKLOAD, REGISTERED, QUARANTINED - DO NOT USE, PRE-SHIPMENT INSECTION<br>306750 | 245.00      | 80.00      |
| DO NOT REMOVE FROM WORKSITE<br>306751   | 150.00      | 80.00      |
| MOTHBALLLED EQUIPMENT<br>306752   | 150.00      | 80.00      |

| Order Reference  | Height (mm) | Width (mm) |
|--|-------------|------------|
| RENTAL EQUIPMENT, RETURN PROMPTLY<br>306753              | 150.00      | 80.00      |
| VENDOR OWNED EQUIPMENT<br>306754                         | 150.00      | 80.00      |
| RENTAL EQUIPMENT<br>306755                               | 150.00      | 80.00      |
| REPORTED FAULT<br>306756                                 | 150.00      | 80.00      |
| SHUTDOWN<br>306757                                       | 150.00      | 80.00      |
| THIS HOSE IS IN USE BY: OPERATIONS<br>306758             | 150.00      | 80.00      |
| THIS HOSE IS IN USE BY: SERVICES/ CONSTRUCTION<br>306759 | 150.00      | 80.00      |
| 306760   | 260.00      | 80.00      |
| OPEN<br>306765   | 150.00      | 80.00      |
| CLOSED<br>306766   | 150.00      | 80.00      |
| DO NOT OPERATE, DO NOT OPERATE<br>306767                 | 150.00      | 80.00      |
| SHUTDOWN ISOLATION<br>306768                             | 150.00      | 80.00      |
| LSA CONTAMINATED<br>306769                               | 150.00      | 80.00      |
| LSA FREE<br>306770                                       | 150.00      | 80.00      |
| NORM CONTAMINATED<br>306771                              | 150.00      | 80.00      |

| Order Reference  | Height (mm) | Width (mm) |
|--|-------------|------------|
| NORM FREE<br>306772  | 150.00      | 80.00      |
| NORM CONTAMINATED<br>306773  | 161.00      | 80.00      |
| SPADE<br>306737  | 176.00      | 80.00      |
| LEAD ID<br>306746  | 150.00      | 80.00      |
| LEAK TESTING PERSONAL ISOLATION TAG, SYSTEM VALVE OPEN, DO NOT CLOSE VALVE<br>306747     | 150.00      | 80.00      |
| LEAK TESTING PERSONAL ISOLATION TAG, BOUNDARY VALVE CLOSED, DO NOT CLOSE VALVE<br>306748 | 150.00      | 80.00      |
| EQUIPMENT CHECKED FOR NORM/LSA CONTAMINATION<br>306774                                   | 150.00      | 80.00      |
| CAUTION DEFECTIVE EQUIPMENT<br>306775  | 150.00      | 80.00      |
| CRITICAL VALVE LOCKED OPEN<br>306761   | 41.00       |            |
| CRITICAL VALVE LOCKED CLOSED<br>306762   | 41.00       |            |
| VALVE LOCKED OPEN<br>306763  | 41.00       |            |
| VALVE LOCKED CLOSED<br>306764  | 41.00       |            |
| DO NOT HIRE<br>306731  | 299.00      | 60.00      |
| READY FOR HIRE<br>306732   | 299.00      | 60.00      |

## Photo tags

Photo tags can be personalised by writing on special instructions, hazards or warnings and also has an area where a relevant employee photograph can be included which will give a more personal message.

- Constructed of durable B-851 polyester
- Available with or without 1 mil (25,4 µm) polyester laminate on front
- Includes nylon fasteners



| Order Reference | Description                   | Height (mm) | Width (mm) | Quantity |
|-----------------|-------------------------------|-------------|------------|----------|
| 065500          | Photo Tags (without laminate) | 146.05      | 76.20      | 25       |
| 065501          | Self-laminating Photo Tags    | 146.05      | 76.20      | 10       |
| 096222          | Self-laminating Photo Tags    | 177.80      | 76.20      | 10       |

## Machine related risk warning tags

- Pre-printed warning layout and blank reverse
- B-851 Heavy Duty Polyester
- Packaging: 10 tags

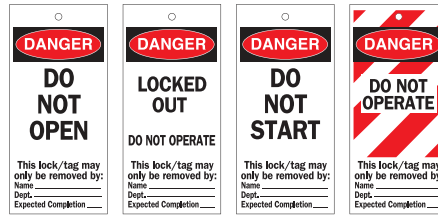

| Height (mm) | Width (mm) | Order Reference             |
|-------------|------------|-----------------------------|
| 160.00      | 75.00      | 230778 230779 230780 230781 |



## RipTag™ safety tag roll

With RipTag Safety Tag Roll you get a complete system for tagging hazardous areas in your facility so you can keep employees safe.

- Compliance with OSHA's 50 lb. pull force regulation for lockout tagout
- Easy storage options
- System includes a bulk roll of tags and cable ties for quick attachment.

| Order Reference | Legend   | Quantity |
|-----------------|--|----------|
| 150501          | DO NOT OPERATE This lock/tag may only be removed by: Name _____ Date _____ | 100      |
| 150502          | DO NOT OPERATE This lock/tag may only be removed by: Name _____ Date _____ | 250      |
| 150503          | DO NOT OPERATE This lock/tag may only be removed by: Name _____ Date _____ | 100      |
| 150504          | DO NOT OPERATE This lock/tag may only be removed by: Name _____ Date _____ | 250      |



| Order Reference | Legend  | Quantity |
|-----------------|---|----------|
| 307665          | DO NOT OPERATE This Lock/Tag may only be removed by | 5        |
| 307666          | Nicht schalten                                      | 5        |
| 307667          | Ne pas utiliser                                     | 5        |
| 307668          | Niet bedienen                                       | 5        |
| 307669          | No operar   | 5        |
| 307670          | Non utilizzare                                      | 5        |
| 307671          | Nie załączac  | 5        |
| 307672          | ÇALIŞTIRMAYIN                                       | 5        |
| 307673          | He uiconob30Batb                                    | 5        |
| 307674          | Använd inte   | 5        |
| 307675          | Ne müködtesse                                       | 5        |
| 307676          | Nezapinat   | 5        |
| 307677          | Nezapinat   | 5        |
| 307678          | Nu utilizați  | 5        |

## Re-writable lockout tags

- Height: 160 mm, Width: 75 mm
- Material: Rigid PVC tag with polyester overlaminated





## Two-part perforated tags

Two-part tags provide enhanced operational control and record keeping.

The stub is removed when the tag is attached to a lockout point. Only the employee in possession of the stub has the authority to remove the tag. After the job is done, the stub is returned to management for verification and monitoring of Lockout/Tagout activity in the plant. Matching identification numbers are printed on each part.



Reverse

### Heavy cardstock tags

- Economical cardstock tags are easy to write on using pen, pencil or permanent marker (B-853)
- Tear resistant 9.5 mm rolled brass eyelet
- Tie strings included for quick, easy attachment

### Polyester tags

- 10 mil (1 mil = 25,4 µm) thick polyester enhances durability and makes it easy to remove chemicals, grease and grime (B-851)
- Write-on surface accepts marker, pen or pencil
- Weatherproof for outdoor use
- 9.5 mm rolled brass eyelet that fits over most padlock shackles
- Nylon cable ties included for easy, secure attachment

| Order Reference | Text/Legend          | Material             | Brady Material No. | Height (mm) | Width (mm) | Quantity |
|-----------------|----------------------|----------------------|--------------------|-------------|------------|----------|
| 105371          | DO NOT OPERATE       | Heavy Duty Polyester | B-851              | 177.80      | 101.60     | 25       |
| 105373          | DO NOT OPERATE       | Paper Cardstock      | B-853              | 177.80      | 101.60     | 25       |
| 105370          | EQUIPMENT LOCKED OUT | Heavy Duty Polyester | B-851              | 177.80      | 101.60     | 25       |
| 105372          | EQUIPMENT LOCKED OUT | Paper Cardstock      | B-853              | 177.80      | 101.60     | 25       |

## Mini tags

- Suitable for use with TagLock, see page 55

| Order Reference | Text/Legend            | Material | Height (mm) | Width (mm) | Quantity |
|-----------------|------------------------|----------|-------------|------------|----------|
| 148824          | DANGER, DO NOT OPERATE | Plastic  | 63.50       | 50.80      | 25       |



## Laminat™ tags

Self-sealing manila tags for identification of material in tough environments, including valves, instruments, motors and other industrial components.

- Laminat™ manila tags are recommended to be used together with Brady's assortment of labels
- Material: B-7645 Polypropylene Tag with Polyester Overlaminat
- Colour: Yellow
- There are two versions of the tag, either supplied with or without stainless steel reinforcement ring

| Order Reference | Height (mm) | Width (mm) | Seal-up Area Height (mm) | Seal-up Area Width (mm) | Additional Information | Quantity |
|-----------------|-------------|------------|--------------------------|-------------------------|------------------------|----------|
| 620321          | 25.00       | 59.00      | 25.00                    | 43.00                   | —                      | 50       |
| 620322          | 25.00       | 59.00      | 25.00                    | 43.00                   | Reinforced with Rivet  | 50       |
| 620323          | 25.00       | 150.00     | 25.00                    | 135.00                  | —                      | 50       |
| 620324          | 25.00       | 150.00     | 25.00                    | 135.00                  | Reinforced with Rivet  | 50       |
| 622493          | 60.00       | 116.00     | 60.00                    | 100.00                  | Reinforced with Rivet  | 50       |



## Blank utility tags

- Durable tags have a label area that allow your own custom printed label to be attached
- These tag are lightweight, non-corrosive, non conductive and impact resistant, have rounded corners and are hole punched
- Material: Laminated Polyester on a Plastic Tag
- Label area large tags: 106.60 x 63.50 mm
- Label area small tags: 76.20 x 38.10 mm
- Tags are sold individually



| Order Reference | Description            | Colour   | Width (mm) | Height (mm) |
|-----------------|------------------------|----------|------------|-------------|
| 041921          | Blank VIP Tags - Large | ● Black  | 119.38     | 81.28       |
| 041923          | Blank VIP Tags - Large | ● Yellow | 119.38     | 81.28       |
| 041925          | Blank VIP Tags - Large | ● Red    | 119.38     | 81.28       |
| 041927          | Blank VIP Tags - Large | ● Blue   | 119.38     | 81.28       |
| 041929          | Blank VIP Tags - Large | ● Green  | 119.38     | 81.28       |
| 087695          | Blank VIP Tags - Large | ● Orange | 119.38     | 81.28       |
| 087697          | Blank VIP Tags - Large | ○ White  | 119.38     | 81.28       |
| 087699          | Blank VIP Tags - Large | ● Grey   | 119.38     | 81.28       |
| 041920          | Blank VIP Tags - Small | ● Black  | 93.98      | 55.88       |
| 041922          | Blank VIP Tags - Small | ● Yellow | 93.98      | 55.88       |
| 041924          | Blank VIP Tags - Small | ● Red    | 93.98      | 55.88       |
| 041926          | Blank VIP Tags - Small | ● Blue   | 93.98      | 55.88       |
| 041928          | Blank VIP Tags - Small | ● Green  | 93.98      | 55.88       |
| 087694          | Blank VIP Tags - Small | ● Orange | 93.98      | 55.88       |
| 087696          | Blank VIP Tags - Small | ○ White  | 93.98      | 55.88       |
| 087698          | Blank VIP Tags - Small | ● Grey   | 93.98      | 55.88       |

**i** Print your labels using any of the printers in Brady's wide range of sign and label printers. See page 83 for details.

## Tag holder

- Compact - holds 50 tags, ties and marking pen (not included)
- Comes with adhesive strips and screws for mounting in a variety of ways
- Dimensions (H x W x D): 190 mm x 114 mm x 38 mm

**No tags included.**

| Order Reference | Description | Material      | Quantity |
|-----------------|-------------|---------------|----------|
| 800125          | Tag Holder  | Clear Plastic | 1        |



## Safety tag station

Organise your tags in a central position!

- Material: Rugged Polycarbonate Plastic construction
- Accommodates 146 x 76 mm tags

**No tags included.**

| Order Reference | Description                  | Material             | Quantity |
|-----------------|------------------------------|----------------------|----------|
| 081773          | 10-Pocket Tag Safety Station | Rugged Polycarbonate | 1        |



## Magnetic signs

- Easy to apply and remove
- Packaging: 5 pieces



| Width (mm) | Height (mm) | Order Reference |
|------------|-------------|-----------------|
| 105.00     | 148.00      | 256964          |
|            |             | 256965          |
|            |             | 256966          |
|            |             | 256967          |



## Brady inspection timer

The innovative Brady Inspection Timer can help save lives by clearly showing on machines, equipment and tools when maintenance is needed. Its LED lights grab the attention of users and maintenance professionals alike from a distance and help avoid the use of uninspected or worn out equipment.

- Dark green, light green, yellow and flashing red LED's indicate when maintenance is due
- Applicable to almost any machine, equipment or tool and has 1 year+ battery power

| Order Reference | Description                       | Colour | Shape  | Expiration Time | Includes                   |
|-----------------|-----------------------------------|--------|--------|-----------------|----------------------------|
| 150748          | Brady Inspection Timer - 180 days | Blue   | Circle | 180 Days        | 3 - AAA Alkaline Batteries |
| 150746          | Brady Inspection Timer - 30 days  | Blue   | Circle | 30 Days         | 3 - AAA Alkaline Batteries |
| 150749          | Brady Inspection Timer - 365 days | Blue   | Circle | 365 Days        | 3 - AAA Alkaline Batteries |
| 150745          | Brady Inspection Timer - 7 days   | Blue   | Circle | 7 Days          | 3 - AAA Alkaline Batteries |
| 150747          | Brady Inspection Timer - 90 days  | Blue   | Circle | 90 Days         | 3 - AAA Alkaline Batteries |





For more information:  
[www.bradyeurope.com/InspectionTimer](http://www.bradyeurope.com/InspectionTimer)

## Coloured nylon ties

Coloured nylon ties provide you with an option of colour coded application.

| Order Reference | Colour  | Width (mm) | Length (mm) | Quantity |
|-----------------|---------|------------|-------------|----------|
| 196310          | Natural | 3.50       | 140.00      | 100      |
| 196337          | Blue    | 3.60       | 140.00      | 100      |
| 196340          | Green   | 3.60       | 140.00      | 100      |
| 196343          | Red     | 3.60       | 140.00      | 100      |
| 196311          | Natural | 3.50       | 200.00      | 100      |
| 196349          | Blue    | 3.60       | 200.00      | 100      |
| 196351          | Red     | 3.60       | 200.00      | 100      |



# Energy source labels & tags



Energy source tags can be used to mark your facility's points of control for energy sources. These tags help make the lockout process quicker, safer and easier.

## Control panel



Rigid Polypropylene, 75.00 x 38.00 mm, pack of 25 tags

| Order Reference | Text/Legend |
|-----------------|-------------|
| 138396          | CP-1        |
| 138397          | CP-2        |
| 138398          | CP-3        |
| 138732          | CP-4        |
| 138733          | CP-5        |
| 138734          | CP-6        |
| 138735          | CP-7        |
| 138736          | CP-8        |
| 138737          | CP-9        |
| 138738          | CP-10       |

## Valve



Polypropylene, 75.00 x 38.00 mm, pack of 25 tags

| Order Reference | Text/Legend |
|-----------------|-------------|
| 138439          | V-1         |
| 138440          | V-2         |
| 138441          | V-3         |
| 138442          | V-4         |
| 138443          | V-5         |
| 138787          | V-6         |
| 138788          | V-7         |
| 138789          | V-8         |
| 138790          | V-9         |
| 138791          | V-10        |
| 138792          | V-11        |
| 138793          | V-12        |
| 138794          | V-13        |
| 138795          | V-14        |
| 138796          | V-15        |
| 138797          | V-16        |
| 138798          | V-17        |
| 138799          | V-18        |
| 138800          | V-19        |
| 138801          | V-20        |

## Thermal



Polypropylene, 75.00 x 38.00 mm, pack of 25 tags

| Order Reference | Text/Legend |
|-----------------|-------------|
| 138434          | T-1         |
| 138437          | T-2         |
| 138438          | T-3         |
| 138780          | T-4         |
| 138781          | T-5         |
| 138782          | T-6         |
| 138783          | T-7         |
| 138784          | T-8         |
| 138785          | T-9         |
| 138786          | T-10        |

## Pneumatic



Polypropylene, 75.00 x 38.00 mm, pack of 25 tags

| Order Reference | Text/Legend |
|-----------------|-------------|
| 138405          | P-1         |
| 138406          | P-2         |
| 138407          | P-3         |
| 138408          | P-4         |
| 138409          | P-5         |
| 138739          | P-6         |
| 138740          | P-7         |
| 138741          | P-8         |
| 138742          | P-9         |
| 138743          | P-10        |

## Hydraulic



Polypropylene, 75.00 x 38.00 mm, pack of 25 tags

| Order Reference | Text/Legend |
|-----------------|-------------|
| 138410          | H-1         |
| 138411          | H-2         |
| 138412          | H-3         |
| 138744          | H-4         |
| 138745          | H-5         |
| 138746          | H-6         |
| 138747          | H-7         |
| 138748          | H-8         |
| 138749          | H-9         |
| 138750          | H-10        |

## Kinetic



Polypropylene, 75.00 x 38.00 mm, pack of 25 tags

| Order Reference | Text/Legend |
|-----------------|-------------|
| 138431          | K-1         |
| 138432          | K-2         |
| 138433          | K-3         |
| 138773          | K-4         |
| 138774          | K-5         |
| 138775          | K-6         |
| 138776          | K-7         |
| 138777          | K-8         |
| 138778          | K-9         |
| 138779          | K-10        |

## Glycol



Polypropylene, 75.00 x 38.00 mm, pack of 25 tags

| Order Reference | Text/Legend |
|-----------------|-------------|
| 138444          | GL-1        |
| 138445          | GL-2        |
| 138446          | GL-3        |
| 138802          | GL-4        |
| 138803          | GL-5        |
| 138804          | GL-6        |
| 138805          | GL-7        |
| 138806          | GL-8        |
| 138807          | GL-9        |
| 138808          | GL-10       |

## Water



Polypropylene, 75.00 x 38.00 mm, pack of 25 tags

| Order Reference | Text/Legend |
|-----------------|-------------|
| 138413          | W-1         |
| 138414          | W-2         |
| 138415          | W-3         |
| 138416          | W-4         |
| 138417          | W-5         |
| 138751          | W-6         |
| 138752          | W-7         |
| 138753          | W-8         |
| 138754          | W-9         |
| 138755          | W-10        |

## Steam



Polypropylene, 75.00 x 38.00 mm, pack of 25 tags

| Order Reference | Text/Legend |
|-----------------|-------------|
| 138423          | S-1         |
| 138424          | S-2         |
| 138425          | S-3         |
| 138426          | S-4         |
| 138427          | S-5         |
| 138761          | S-6         |
| 138762          | S-7         |
| 138763          | S-8         |
| 138764          | S-9         |
| 138765          | S-10        |

## Gas



Polypropylene, 75.00 x 38.00 mm, pack of 25 tags

| Order Reference | Text/Legend |
|-----------------|-------------|
| 138418          | G-1         |
| 138419          | G-2         |
| 138420          | G-3         |
| 138421          | G-4         |
| 138422          | G-5         |
| 138756          | G-6         |
| 138757          | G-7         |
| 138758          | G-8         |
| 138759          | G-9         |
| 138760          | G-10        |

## Chemical



Polypropylene, 75.00 x 38.00 mm, pack of 25 tags

| Order Reference | Text/Legend |
|-----------------|-------------|
| 138428          | C-1         |
| 138429          | C-2         |
| 138430          | C-3         |
| 138766          | C-4         |
| 138767          | C-5         |
| 138768          | C-6         |
| 138769          | C-7         |
| 138770          | C-8         |
| 138771          | C-9         |
| 138772          | C-10        |

## Electrical



Rigid Polypropylene, 75.00 x 38.00 mm, pack of 25 tags

| Order Reference | Text/Legend |
|-----------------|-------------|
| 138399          | E-1         |
| 138401          | E-2         |
| 138402          | E-3         |
| 138403          | E-4         |
| 138404          | E-5         |
| 138447          | E-6         |
| 138448          | E-7         |
| 138449          | E-8         |
| 138450          | E-9         |
| 138451          | E-10        |
| 138829          | E-11        |
| 138830          | E-12        |
| 138831          | E-13        |
| 138832          | E-14        |
| 138833          | E-15        |
| 138834          | E-16        |
| 138835          | E-17        |
| 138836          | E-18        |
| 138837          | E-19        |
| 138838          | E-20        |

Laminated Polyester, 19.00 x 13.00 mm, sheet of 100 labels

| Order Reference | Text/Legend |
|-----------------|-------------|
| 138452          | E-1         |
| 138453          | E-2         |
| 138454          | E-3         |
| 138455          | E-4         |
| 138456          | E-5         |
| 138457          | E-6         |
| 138458          | E-7         |
| 138459          | E-8         |
| 138460          | E-9         |
| 138461          | E-10        |
| 138809          | E-11        |
| 138810          | E-12        |
| 138811          | E-13        |
| 138812          | E-14        |
| 138813          | E-15        |
| 138814          | E-16        |
| 138815          | E-17        |
| 138816          | E-18        |
| 138817          | E-19        |
| 138818          | E-20        |

Laminated Polyester, 75.00 x 38.00 mm, sheet of 5 labels

| Order Reference | Text/Legend |
|-----------------|-------------|
| 138462          | E-1         |
| 138463          | E-2         |
| 138464          | E-3         |
| 138465          | E-4         |
| 138466          | E-5         |
| 138467          | E-6         |
| 138468          | E-7         |
| 138469          | E-8         |
| 138470          | E-9         |
| 138471          | E-10        |
| 138819          | E-11        |
| 138820          | E-12        |
| 138821          | E-13        |
| 138822          | E-14        |
| 138823          | E-15        |
| 138824          | E-16        |
| 138825          | E-17        |
| 138826          | E-18        |
| 138827          | E-19        |
| 138828          | E-20        |



Brady sign and label printers with their industrial design and excellent printing outcomes are highly recommended for identification of LO/TO devices, lockout points, padlocks and keys.

## BMP41 Label Printer

The BMP41 Label printer is a rugged, portable solution that gives you the versatility to create die-cut or continuous labels, anywhere, anytime!

- Prints on labels and tapes up to 25 mm wide

| Order Reference | Description              |
|-----------------|--------------------------|
| 711213          | BMP41 Label Printer - UK |
| 133254          | BMP41 Label Printer - EU |

This printer ships in a hard case with a Nickel Battery Pack, MC1-1000-595-WT-BK cartridge, USB cable, AC adapter, power cord, Brady Workstation Suite, Product CD, Brady printer Drivers CD and Quick Start Guide



Visit the BMP41 site on [bradyeurope.com/bmp41](http://bradyeurope.com/bmp41)

## BMP51 Label Maker

The Brady BMP51 Label Maker offers crisp printing, easy formatting, convenient label sizes and portability to solve a number of identification tasks. Besides stand-alone and PC connected operation, it offers great option of wireless printing via Bluetooth® and WiFi.

- Prints on labels and tapes up to 38 mm wide

| Order Reference | Description              |
|-----------------|--------------------------|
| 710894          | BMP51 Label Printer - EU |
| 710898          | BMP51 Label Printer - UK |

This printer ships in a hard case with a Rechargeable Lithium Ion Battery, USB Cable, AC adaptor + EU power cord, Brady Workstation Basic Suite, Product CD, Brady Printer Drivers CD, Quick Start Guide, a Bluetooth network card and an MC1-1000-422 cartridge.



Visit de BMP51 site on [bradyeurope.com/bmp51](http://bradyeurope.com/bmp51)

## BMP71 Label Printer

Brady's high-end portable label printer. Beside cable and wire printing solution for the telecom/datacom and electrical markets, the BMP71 is also perfect for printing health and safety signs and labels for the process industries.

The BMP71 is a user friendly printer with a large full colour LCD display, an easy-to-use menu driven user interface, and a full keyboard layout making it quick and easy to create labels using text, symbols and coding. It can be used as stand-alone unit, as well as PC connected.

- Prints on labels and tapes up to 50.8 mm wide

| Order Reference | Description                     |
|-----------------|---------------------------------|
| 710599          | BMP71 Label Printer - QWERTY EU |
| 710600          | BMP71 Label Printer - QWERTY UK |
| 710601          | BMP71 Label Printer - AZERTY    |
| 710603          | BMP71 Label Printer - QWERTZ    |
| 710604          | BMP71 Label Printer - CYRILLIC  |



Watch the BMP71 video on Brady's YouTube™ channel.

This printer kit ships in a hard case with Rechargeable NiMH Battery, AC Adaptor, USB Communications Cable, TLS2200® / HandiMark™ Material Roll Adaptor, Quick Start Guide, Product CD (w/ Printer Driver, Tutorials, Full User's Guide), Cleaning Kit, a Brady Workstation Basic Suite, M71C-2000-595-WT, M71-31-423 and M71-R6000

## S3100 Sign & Label Printer



**i** Watch the S3100 video on Brady's YouTube™ channel.

Designed for ease of use and versatility, this monochrome printer features an intuitive touch screen display, simple label design and a wide variety of materials and applications.

- Prints on labels and tapes from 12.70 wide to 101 mm wide

| Article No. | Description  | Article No. | Description                              |
|-------------|--|-------------|--|
| 149118      | S3100 Sign and Label Printer with Wifi - QWERTZ    | 149120      | S3100 Sign and Label Printer - QWERTY US |
| 149119      | S3100 Sign and Label Printer with Wifi - QWERTY UK | 149126      | S3100 Sign and Label Printer - QWERTY EU |
| 149121      | S3100 Sign and Label Printer with Wifi - QWERTY US | 149517      | S3100 Sign and Label Printer - AZERTY    |
| 149122      | S3100 Sign and Label Printer with Wifi - AZERTY    | 149519      | S3100 Sign and Label Printer - QWERTZ    |
| 149123      | S3100 Sign and Label Printer with Wifi - CYRILLIC  |             |  |
| 149127      | S3100 Sign and Label Printer with Wifi - QWERTY EU |             |  |

## BBP35 Multicolour Sign & Label Printer BBP37 Multicolour & Cut Sign & Label Printer



**i** Watch the BBP37 video on Brady's YouTube™ channel.

Brady's BBP35 and BBP37 sign and label printers give you the power to make signs and labels in the colours and shapes you need to make an impact – right at your own facility and right when you need them. With remarkable multi-colour printing, versatile shape-cutting capabilities and impressively fast print speeds, you won't remember how you lived without one of these printers.

- Prints on labels and tapes from 12.70 wide to 101 mm wide

| Order Reference | Description  | Order Reference | Description  |
|-----------------|--|-----------------|--|
| 143635          | BBP35 Multicolour Sign and Label Printer AZERTY      | 143640          | BBP37 Multicolour and Cut Sign and Label Printer AZERTY      |
| 143637          | BBP35 Multicolour Sign and Label Printer CYRILLIC    | 143642          | BBP37 Multicolour and Cut Sign and Label Printer CYRILLIC    |
| 143634          | BBP35 Multicolour Sign and Label Printer QWERTY - EU | 143639          | BBP37 Multicolour and Cut Sign and Label Printer QWERTY - EU |
| 145996          | BBP35 Multicolour Sign and Label Printer QWERTY - UK | 145995          | BBP37 Multicolour and Cut Sign and Label Printer QWERTY - UK |
| 143633          | BBP35 Multicolour Sign and Label Printer QWERTY - US | 143638          | BBP37 Multicolour and Cut Sign and Label Printer QWERTY - US |
| 143636          | BBP35 Multicolour Sign and Label Printer QWERTZ      | 143641          | BBP37 Multicolour and Cut Sign and Label Printer QWERTZ      |



## B-551 Non-adhesive continuous tag stock

For safety, lockout and general purpose hanging tags

- Non-adhesive, polyester stock
- Hole punch available separately. Order reference: 020591
- Optional snap-in grommets available. Order Reference: 020596
- Meets OSHA 50lb pullout spec for lockout tags



| Fits Printer Model(s)             | Order Reference  | Colour | Width A (mm) | Length B (m) |
|-----------------------------------|------------------|--------|--------------|--------------|
| S3100, BBP31, BBP33, BBP35, BBP37 | B30C-2500-551-WT | White  | 64.00        | 15.24        |
| S3100, BBP31, BBP33, BBP35, BBP37 | B30C-3250-551-WT | White  | 83.00        | 15.24        |
| S3100, BBP31, BBP33, BBP35, BBP37 | B30C-4250-551-WT | White  | 108.00       | 15.24        |

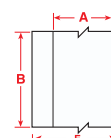

## BBP85 Sign and Label Printer

The BBP85 Sign and Label Printer allows you to create up to 254.00 mm labels & signs in multiple colours. Its touch-screen interface makes it easy to use for anyone.

- Highly durable multi-colour thermal transfer printing
- Prints stand-alone or from your PC
- Timesaving label design apps to create pipe markers, safety signs, right-to-know labels and more
- The ideal printer for multi-user Lean, 5S and Kaizen Labelling events



| Order Reference | Description  |
|-----------------|--|
| 198566          | BBP85 Sign & Label Printer - AZERTY with Brady Workstation SFID Suite    |
| 198567          | BBP85 Sign & Label Printer - CYRILLIC with Brady Workstation SFID Suite  |
| 198568          | BBP85 Sign & Label Printer - QWERTY EU with Brady Workstation SFID Suite |
| 198570          | BBP85 Sign & Label Printer - QWERTY UK with Brady Workstation SFID Suite |
| 198571          | BBP85 Sign & Label Printer - QWERTZ with Brady Workstation SFID Suite    |



## Brady Workstation software suites

### Brady Workstation Safety and Facility Identification Software Suite

Keep your facility safe and compliant by creating custom signs, label and pipemarkers, adding visual safety guidance.

[Workstation.BradyID.com/SafetyAndFacility](http://Workstation.BradyID.com/SafetyAndFacility)



Discover it at [www.bradyeurope.com/workstation](http://www.bradyeurope.com/workstation)

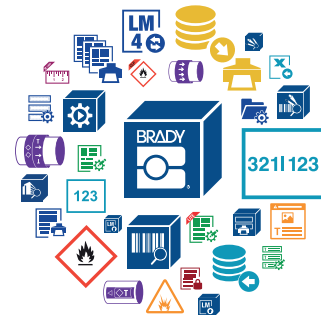

## CAUTION

AREA IN FRONT OF THIS ELECTRICAL PANEL MUST BE KEPT CLEAR FOR 36 INCHES. OSHA-NEC REGULATIONS

## B-595 pre-printed pre-cut blank sign headers

For creating Arc Flash and safety warning labels in seconds.

- Allows the printer to create multi-colour signs fast - in a single print pass
- Headers meet OSHA 1910.145 and ASME/ANSI Z535 standards
- Indoor/Outdoor grade material conforms to rough, irregular and "difficult to adhere to" surfaces



| Printer Compatibility | Art. No.                |  | Width (mm) | Height (mm) | Quantity | Recommended Ribbon |
|-----------------------|-------------------------|--|------------|-------------|----------|--------------------|
| BBP85                 | B85-102x152-595-OSHACA  |  | 102.00     | 152.00      | 95       | B85-R-158x60-BK    |
| BBP85                 | B85-178x254-595-OSHACA  |  | 178.00     | 254.00      | 60       | B85-R-220x60-BK    |
| BBP85                 | B85-254x356-7569-OSHACA |  | 254.00     | 356.00      | 40       | B85-R-220x60-BK    |
| BBP85                 | B85-102x152-595-ANSICA  |  | 102.00     | 152.00      | 95       | B85-R-158x60-BK    |
| BBP85                 | B85-178x254-595-ANSICA  |  | 178.00     | 254.00      | 60       | B85-R-220x60-BK    |
| BBP85                 | B85-254x356-7569-ANSICA |  | 254.00     | 356.00      | 40       | B85-R-220x60-BK    |
| BBP85                 | B85-102x152-595-OSHADA  |  | 102.00     | 152.00      | 95       | B85-R-158x60-BK    |
| BBP85                 | B85-178x254-595-OSHADA  |  | 178.00     | 254.00      | 60       | B85-R-220x60-BK    |
| BBP85                 | B85-254x356-7569-OSHADA |  | 254.00     | 356.00      | 40       | B85-R-220x60-BK    |
| BBP85                 | B85-102x152-595-ANSIDA  |  | 102.00     | 152.00      | 95       | B85-R-158x60-BK    |
| BBP85                 | B85-178x254-595-ANSIDA  |  | 178.00     | 254.00      | 60       | B85-R-220x60-BK    |
| BBP85                 | B85-254x356-7569-ANSIDA |  | 254.00     | 356.00      | 40       | B85-R-220x60-BK    |
| BBP85                 | B85-102x152-595-ANSINO  |  | 102.00     | 152.00      | 95       | B85-R-158x60-BK    |
| BBP85                 | B85-178x254-595-ANSINO  |  | 178.00     | 254.00      | 60       | B85-R-220x60-BK    |
| BBP85                 | B85-254x356-7569-ANSINO |  | 254.00     | 356.00      | 40       | B85-R-220x60-BK    |
| BBP85                 | B85-102x152-595-ANSIWA  |  | 102.00     | 152.00      | 95       | B85-R-158x60-BK    |
| BBP85                 | B85-178x254-595-ANSIWA  |  | 178.00     | 254.00      | 60       | B85-R-220x60-BK    |
| BBP85                 | B85-254x356-7569-ANSIWA |  | 254.00     | 356.00      | 40       | B85-R-220x60-BK    |
| BBP85                 | B85-178x254-595-YL      |  | 178.00     | 254.00      | 60       | B85-R-220x60-BK    |
| BBP85                 | B85-254x356-7569-YL     |  | 254.00     | 356.00      | 40       | B85-R-220x60-BK    |
| BBP85                 | B85-178x254-595-WT      |  | 178.00     | 254.00      | 60       | B85-R-220x60-BK    |
| BBP85                 | B85-254x356-7569-WT     |  | 254.00     | 356.00      | 40       | B85-R-220x60-BK    |

## BradyJet J5000 Colour Label Printer



The BradyJet J5000 Colour Label Printer. Full colour safety signs & labels in a few seconds. Brady's inkjet printer quickly prints safety signs, lean labels and pipe markers at location and on demand. The BradyJet J5000 combines high print speed and full colour printing with a durable material range for indoor safety signs.

Quickly create lockout/ tagout procedures, tags and labels with the Brady Workstation Lockout Writer app. It includes procedure printing templates, simple translations and easy-to-use image editing for callouts. Having accurate lockout procedures in place saves lives, and this app streamlines the process to creating those critical aspects to employee safety.

| Order Reference | Description   |
|-----------------|---|
| 197201          | BradyJet J5000 Colour Label Printer - EU with Workstation Lockout Writer CD |
| 197202          | BradyJet J5000 Colour Label Printer - UK with Workstation Lockout Writer CD |
| 197203          | BradyJet J5000 Colour Label Printer - US with Workstation Lockout Writer CD |

### Labels

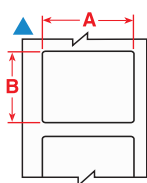
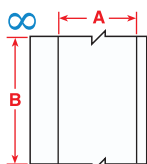

| Diagram                           | Order Reference | Art. No. | Colour | Label Width A (mm) | Label Height B (mm) | Label Length B (m) | Total Qty/ Pack |
|-----------------------------------|-----------------|----------|--------|--------------------|---------------------|--------------------|-----------------|
| <b>Inkjet Receptive Polyester</b> |                 |          |        |                    |                     |                    |                 |
| ▲                                 | J50-260-2569    | 148662   | White  | 55.00              | 85.00               | –                  | 340             |
| ▲                                 | J50-261-2569    | 148661   | White  | 75.00              | 110.00              | –                  | 270             |
| ▲                                 | J50-262-2569    | 148654   | White  | 105.00             | 155.00              | –                  | 200             |
| ▲                                 | J50-267-2569    | 148668   | White  | 155.00             | 210.00              | –                  | 120             |
| ▲                                 | J50-265-2569    | 148667   | White  | 178.00             | 254.00              | –                  | 100             |
| ∞                                 | J50C-2250-2569  | 148665   | White  | 57.00              | –                   | 30 m               | 1               |
| ∞                                 | J50C-4000-2569  | 148658   | White  | 101.00             | –                   | 30 m               | 1               |
| ∞                                 | J50C-6000-2569  | 148652   | White  | 152.00             | –                   | 30 m               | 1               |
| ∞                                 | J50C-8000-2569  | 148655   | White  | 203.20             | –                   | 30 m               | 1               |
| <b>Inkjet Receptive Vinyl</b>     |                 |          |        |                    |                     |                    |                 |
| ▲                                 | J50-260-2595    | 148657   | White  | 55.00              | 85.00               | –                  | 340             |
| ▲                                 | J50-261-2595    | 148660   | White  | 75.00              | 110.00              | –                  | 270             |
| ▲                                 | J50-262-2595    | 148651   | White  | 105.00             | 155.00              | –                  | 200             |
| ▲                                 | J50-267-2595    | 148664   | White  | 155.00             | 210.00              | –                  | 120             |
| ▲                                 | J50-265-2595    | 148659   | White  | 178.00             | 254.00              | –                  | 100             |
| ∞                                 | J50C-2250-2595  | 148656   | White  | 57.00              | –                   | 30 m               | 1               |
| ∞                                 | J50C-4000-2595  | 148653   | White  | 101.00             | –                   | 30 m               | 1               |
| ∞                                 | J50C-6000-2595  | 148666   | White  | 152.00             | –                   | 30 m               | 1               |
| ∞                                 | J50C-8000-2595  | 148663   | White  | 203.20             | –                   | 30 m               | 1               |



### Brady Workstation - Lockout Writer App

Quickly create compliant lockout/tagout labels. This app includes procedure printing templates, simple translations, easy-to-use image editing for callouts.

**Discover it at [www.bradyeurope.com/workstation](http://www.bradyeurope.com/workstation)**



## Reference & index

88 Breaker compatibility overview



# Breaker compatibility overview

- i See page...**
- Standard Circuit Breaker: 56-57
  - EZ Panel Loc™: 54
  - Mini Circuit Breaker Lockouts: 54

|                    |           | Circuit Breaker Lockout (Standard/ TAGLOCK™) |                                      |                                      |                                      |                                      | EZ Panel Loc™ (Standard/ TAGLOCK™)   |                      | Mini Circuit Breaker Lockouts |                 |              |                     |                      |                                |
|--------------------|-----------|--|--------------------------------------|--------------------------------------|--------------------------------------|--------------------------------------|--------------------------------------|----------------------|-------------------------------|-----------------|--------------|---------------------|----------------------|--------------------------------|
| Manufacturer       | Type      | 120V Snap On (w/ hole)                       | 120/277V Clamp On (no hole)          | 480/600V Clamp On (no hole)          | Oversize 480/600V                    | Universal Multi-pole (tie bar)       | Snap On (SQD QO)                     | Clamp On (Universal) | Pin Out Standard              | Pin In Standard | Pin Out Wide | Pin Out Wide Rotary | Multi-pole w/ TieBar | Universal Mini Breaker Lockout |
|                    |           | 065387<br>148689<br>148693<br>148694         | 065396<br>148690<br>148698<br>148699 | 065397<br>148701<br>148687<br>148686 | 065329<br>148692<br>148691<br>148685 | 066321<br>148702<br>148691<br>148695 | 051252<br>148696<br>148697<br>148700 | 051254               | 090844                        | 090847          | 090850       | 149433              | 090853               | 149514                         |
| ABB                | 2CDS25    |  |                                      |                                      |                                      |                                      |                                      |                      |                               |                 |              |                     |                      | •                              |
| ABB                | S202U-K   |  |                                      |                                      |                                      |                                      |                                      | •                    |                               |                 |              |                     |                      |                                |
| ABB                | S202U-K50 |  |                                      |                                      |                                      |                                      |                                      |                      |                               |                 |              |                     |                      | •                              |
| ABB                | S203U-K   |  |                                      |                                      |                                      |                                      |                                      | •                    |                               |                 |              |                     |                      |                                |
| ABB                | S204U-K   |  |                                      |                                      |                                      |                                      |                                      | •                    |                               |                 |              |                     |                      |                                |
| ABB                | S201UP-K  |  |                                      |                                      |                                      |                                      |                                      | •                    |                               |                 |              |                     |                      |                                |
| ABB                | S202UP-K  |  |                                      |                                      |                                      |                                      |                                      | •                    |                               |                 |              |                     |                      |                                |
| ABB                | S203UP-K  |  |                                      |                                      |                                      |                                      |                                      | •                    |                               |                 |              |                     |                      |                                |
| ABB                | S204UP-K  |  |                                      |                                      |                                      |                                      |                                      | •                    |                               |                 |              |                     |                      |                                |
| ABB                | S201U-Z   |  |                                      |                                      |                                      |                                      |                                      | •                    |                               |                 |              |                     |                      |                                |
| ABB                | S202U-Z   |  |                                      |                                      |                                      |                                      |                                      | •                    |                               |                 |              |                     |                      |                                |
| ABB                | S203U-Z   |  |                                      |                                      |                                      |                                      |                                      | •                    |                               |                 |              |                     |                      |                                |
| ABB                | S204U-Z   |  |                                      |                                      |                                      |                                      |                                      | •                    |                               |                 |              |                     |                      |                                |
| ABB                | S201UP-Z  |  |                                      |                                      |                                      |                                      |                                      | •                    |                               |                 |              |                     |                      |                                |
| ABB                | S202UP-Z  |  |                                      |                                      |                                      |                                      |                                      | •                    |                               |                 |              |                     |                      |                                |
| ABB                | S203UP-Z  |  |                                      |                                      |                                      |                                      |                                      | •                    |                               |                 |              |                     |                      |                                |
| ABB                | S204UP-Z  |  |                                      |                                      |                                      |                                      |                                      | •                    |                               |                 |              |                     |                      |                                |
| ABB                | F202AC    |  |                                      |                                      |                                      |                                      |                                      | •                    |                               |                 |              |                     |                      |                                |
| ABB                | F672      |  |                                      |                                      |                                      |                                      |                                      | •                    |                               |                 |              |                     |                      |                                |
| ABB                | F204AC    |  |                                      |                                      |                                      |                                      |                                      | •                    |                               |                 |              |                     |                      |                                |
| ABB                | F674      |  |                                      |                                      |                                      |                                      |                                      | •                    |                               |                 |              |                     |                      |                                |
| ABB                | S281-Z    |  |                                      |                                      |                                      |                                      |                                      | •                    |                               |                 |              |                     |                      |                                |
| ABB                | S282-Z    |  |                                      |                                      |                                      |                                      |                                      | •                    |                               |                 |              |                     |                      |                                |
| ABB                | S283-Z    |  |                                      |                                      |                                      |                                      |                                      | •                    |                               |                 |              |                     |                      |                                |
| ABB                | S281UC-Z  |  |                                      |                                      |                                      |                                      |                                      | •                    |                               |                 |              |                     |                      |                                |
| ABB                | S282UC-Z  |  |                                      |                                      |                                      |                                      |                                      | •                    |                               |                 |              |                     |                      |                                |
| ABB                | S283UC-Z  |  |                                      |                                      |                                      |                                      |                                      | •                    |                               |                 |              |                     |                      |                                |
| ABB                | S501-B    |  |                                      |                                      |                                      |                                      |                                      |                      |                               | •               |              |                     |                      |                                |
| ABB                | S502-B    |  |                                      |                                      |                                      |                                      |                                      |                      |                               | •               |              |                     |                      |                                |
| ABB                | S503-B    |  |                                      |                                      |                                      |                                      |                                      |                      |                               | •               |              |                     |                      |                                |
| ABB                | S501-C    |  |                                      |                                      |                                      |                                      |                                      |                      |                               | •               |              |                     |                      |                                |
| ABB                | S502-C    |  |                                      |                                      |                                      |                                      |                                      |                      |                               | •               |              |                     |                      |                                |
| ABB                | S503-C    |  |                                      |                                      |                                      |                                      |                                      |                      |                               | •               |              |                     |                      |                                |
| ABB                | S501-D    |  |                                      |                                      |                                      |                                      |                                      |                      |                               | •               |              |                     |                      |                                |
| ABB                | S502-D    |  |                                      |                                      |                                      |                                      |                                      |                      |                               | •               |              |                     |                      |                                |
| ABB                | S503-D    |  |                                      |                                      |                                      |                                      |                                      |                      |                               | •               |              |                     |                      |                                |
| ABB                | S501-K    |  |                                      |                                      |                                      |                                      |                                      |                      |                               | •               |              |                     |                      |                                |
| ABB                | S502-K    |  |                                      |                                      |                                      |                                      |                                      |                      |                               | •               |              |                     |                      |                                |
| ABB                | S503-K    |  |                                      |                                      |                                      |                                      |                                      |                      |                               | •               |              |                     |                      |                                |
| ABB                | S501UC-B  |  |                                      |                                      |                                      |                                      |                                      |                      |                               | •               |              |                     |                      |                                |
| ABB                | S502UC-B  |  |                                      |                                      |                                      |                                      |                                      |                      |                               | •               |              |                     |                      |                                |
| ABB                | S503UC-B  |  |                                      |                                      |                                      |                                      |                                      |                      |                               | •               |              |                     |                      |                                |
| ABB                | S504UC-B  |  |                                      |                                      |                                      |                                      |                                      |                      |                               | •               |              |                     |                      |                                |
| ABB                | S501UC-K  |  |                                      |                                      |                                      |                                      |                                      |                      |                               | •               |              |                     |                      |                                |
| ABB                | S502UC-K  |  |                                      |                                      |                                      |                                      |                                      |                      |                               | •               |              |                     |                      |                                |
| ABB                | S503UC-K  |  |                                      |                                      |                                      |                                      |                                      |                      |                               | •               |              |                     |                      |                                |
| ABB                | S504UC-K  |  |                                      |                                      |                                      |                                      |                                      |                      |                               | •               |              |                     |                      |                                |
| American Ckt. Bkr. | NEF       |  | •*                                   |                                      |                                      |                                      |                                      |                      |                               |                 |              |                     |                      |                                |
| American Ckt. Bkr. | NJJ       |  |                                      | •**                                  | •                                    |                                      |                                      |                      |                               |                 |              |                     |                      |                                |
| AEG                | E82S      |  |                                      |                                      |                                      |                                      |                                      |                      | •                             |                 |              |                     |                      |                                |
| American Switch    | C         |  | •                                    |                                      |                                      |                                      | •                                    | •                    |                               |                 |              |                     |                      |                                |
| Bryant             | BR        | •  | •                                    |                                      |                                      |                                      |                                      |                      |                               |                 |              |                     |                      |                                |
| Bryant             | BR        |  |                                      |                                      |                                      | •                                    |                                      |                      |                               |                 |              |                     |                      |                                |
| Buschmat           | S46       |  |                                      |                                      |                                      |                                      |                                      |                      | •                             |                 |              |                     |                      |                                |
| Challenger         | C         | •  | •                                    |                                      |                                      |                                      |                                      |                      |                               |                 |              |                     |                      |                                |
| Challenger         | C         |  |                                      |                                      |                                      | •                                    |                                      |                      |                               |                 |              |                     |                      |                                |
| Challenger         | CDK       |  |                                      | •                                    |                                      |                                      |                                      |                      |                               |                 |              |                     |                      |                                |
| Challenger         | LM        |  | •                                    |                                      |                                      |                                      |                                      |                      |                               |                 |              |                     |                      |                                |
| Challenger         | NEJ       |  | •*                                   |                                      |                                      |                                      |                                      |                      |                               |                 |              |                     |                      |                                |
| Clipsal            | 4CB       |  |                                      |                                      |                                      |                                      |                                      |                      | •                             |                 |              |                     |                      |                                |
| Crouse Hinds       | MP        |  |                                      |                                      |                                      | •                                    |                                      |                      |                               |                 |              |                     |                      |                                |
| Cutler Hammer      | BA        |  | •                                    |                                      |                                      |                                      |                                      |                      |                               |                 |              |                     |                      |                                |
| Cutler-Hammer      | BAB       | •  | •                                    |                                      |                                      |                                      |                                      |                      |                               |                 |              |                     |                      |                                |
| Cutler-Hammer      | BAB       |  |                                      |                                      |                                      | •                                    |                                      |                      |                               |                 |              |                     |                      |                                |
| Cutler-Hammer      | BD        | •  | •                                    |                                      |                                      |                                      |                                      |                      |                               | •               |              |                     |                      |                                |
| Cutler-Hammer      | BR        | •  | •                                    |                                      |                                      |                                      |                                      |                      |                               | •               |              |                     |                      |                                |
| Cutler-Hammer      | BR        |  |                                      |                                      |                                      | •                                    |                                      |                      |                               | •               |              |                     |                      |                                |
| Cutler-Hammer      | BRH       | •  | •                                    |                                      |                                      |                                      |                                      |                      |                               | •               |              |                     |                      |                                |
| Cutler-Hammer      | BRH       |  |                                      |                                      |                                      | •                                    |                                      |                      |                               | •               |              |                     |                      |                                |
| Cutler-Hammer      | BRHH      |  |                                      |                                      |                                      | •                                    |                                      |                      |                               | •               |              |                     |                      |                                |
| Cutler-Hammer      | CC        |  | •*                                   |                                      |                                      |                                      |                                      |                      |                               |                 |              |                     |                      |                                |
| Cutler-Hammer      | CH        | •  | •                                    |                                      |                                      |                                      |                                      | •                    | •                             |                 |              |                     |                      |                                |
| Cutler-Hammer      | CH        |  |                                      |                                      |                                      | •                                    |                                      |                      |                               | •               |              |                     |                      |                                |
| Cutler-Hammer      | CHH       |  | •*                                   |                                      |                                      |                                      |                                      |                      |                               |                 |              |                     |                      |                                |
| Cutler-Hammer      | CH2       |  |                                      |                                      |                                      | •                                    |                                      |                      |                               | •               |              |                     |                      |                                |
| Cutler-Hammer      | CHB       | •  | •                                    |                                      |                                      |                                      | •                                    | •                    |                               | •               |              |                     |                      |                                |
| Cutler-Hammer      | CHB       |  |                                      |                                      |                                      | •                                    |                                      |                      |                               | •               |              |                     |                      |                                |
| Cutler-Hammer      | CHKD      |  |                                      | •                                    |                                      |                                      |                                      |                      |                               |                 |              |                     |                      |                                |
| Cutler-Hammer      | CHLD      |  |                                      |                                      |                                      | •                                    |                                      |                      |                               |                 |              |                     |                      |                                |
| Cutler-Hammer      | CHMDL     |  |                                      |                                      |                                      | •                                    |                                      |                      |                               |                 |              |                     |                      |                                |
| Cutler-Hammer      | CHND      |  |                                      | •**                                  |                                      |                                      |                                      |                      |                               |                 |              |                     |                      |                                |

\* - Cleat (065404) accessory required    \*\* - Cleat (065406) accessory required

# Breaker compatibility overview

**i See page...**

- Standard Circuit Breaker: 56-57
- EZ Panel Loc™: 54
- Mini Circuit Breaker Lockouts: 54

| Manufacturer  | Type    | Circuit Breaker Lockout (Standard/ TAGLOCK™) |                             |                             |                   |                                | EZ Panel Loc™ (Standard/ TAGLOCK™) |                      | Mini Circuit Breaker Lockouts |                 |              |                     |                      |                                |
|---------------|---------|--|-----------------------------|-----------------------------|-------------------|--------------------------------|------------------------------------|----------------------|-------------------------------|-----------------|--------------|---------------------|----------------------|--------------------------------|
|               |         | 120V Snap On (w/ hole)                       | 120/277V Clamp On (no hole) | 480/600V Clamp On (no hole) | Oversize 480/600V | Universal Multi-pole (tie bar) | Snap On (SQD QO)                   | Clamp On (Universal) | Pin Out Standard              | Pin In Standard | Pin Out Wide | Pin Out Wide Rotary | Multi-pole w/ TieBar | Universal Mini Breaker Lockout |
|               |         | 065387                                       | 065396                      | 065397                      | 065329            | 066321                         | 051252                             | 051254               | 090844                        | 090847          | 090850       | 149433              | 090853               | 149514                         |
|               |         | 148689                                       | 148690                      | 148701                      | 148692            | 148702                         | 148696                             |                      |                               |                 |              |                     |                      |                                |
|               |         | 148693                                       | 148698                      | 148687                      | 148691            | 148697                         | 148688                             |                      |                               |                 |              |                     |                      |                                |
|               |         | 148694                                       | 148699                      | 148686                      | 148665            | 148695                         | 148700                             |                      |                               |                 |              |                     |                      |                                |
| Cutler-Hammer | CHP     | •  | •                           |                             |                   |                                | •                                  | •                    |                               |                 |              |                     |                      |                                |
| Cutler-Hammer | CHP     |  |                             |                             |                   | •                              |                                    | •                    |                               |                 |              |                     |                      |                                |
| Cutler-Hammer | CHQ     |  |                             |                             |                   |                                | •                                  | •                    |                               |                 |              |                     |                      |                                |
| Cutler-Hammer | CHQ     |  |                             |                             |                   | •                              |                                    | •                    |                               |                 |              |                     |                      |                                |
| Cutler-Hammer | CHSW    |  |                             |                             |                   | •                              |                                    | •                    |                               |                 |              |                     |                      |                                |
| Cutler-Hammer | CKD     |  |                             | •                           |                   |                                |                                    |                      |                               |                 |              |                     |                      |                                |
| Cutler-Hammer | CL      | •  | •                           |                             |                   |                                | •                                  | •                    |                               |                 |              |                     |                      |                                |
| Cutler-Hammer | CL      |  |                             |                             |                   | •                              |                                    | •                    |                               |                 |              |                     |                      |                                |
| Cutler-Hammer | CLD     |  |                             |                             | •                 |                                |                                    |                      |                               |                 |              |                     |                      |                                |
| Cutler-Hammer | CLDC    |  |                             |                             | •                 |                                |                                    |                      |                               |                 |              |                     |                      |                                |
| Cutler-Hammer | CMDL    |  |                             |                             | •                 |                                |                                    |                      |                               |                 |              |                     |                      |                                |
| Cutler-Hammer | CND     |  |                             | •**                         |                   |                                |                                    |                      |                               |                 |              |                     |                      |                                |
| Cutler-Hammer | CNDC    |  |                             | •**                         |                   |                                |                                    |                      |                               |                 |              |                     |                      |                                |
| Cutler-Hammer | CSR     |  | •                           |                             |                   |                                |                                    | •                    |                               |                 |              |                     |                      |                                |
| Cutler-Hammer | DK      |  |                             | •                           |                   |                                |                                    |                      |                               |                 |              |                     |                      |                                |
| Cutler-Hammer | E125B   |  | •                           |                             |                   |                                |                                    | •                    |                               |                 |              |                     |                      |                                |
| Cutler-Hammer | E125E   |  | •                           |                             |                   |                                |                                    | •                    |                               |                 |              |                     |                      |                                |
| Cutler-Hammer | E125H   |  | •                           |                             |                   |                                |                                    | •                    |                               |                 |              |                     |                      |                                |
| Cutler-Hammer | E125S   |  | •                           |                             |                   |                                |                                    | •                    |                               |                 |              |                     |                      |                                |
| Cutler-Hammer | ED      |  | •                           |                             |                   |                                |                                    | •                    |                               |                 |              |                     |                      |                                |
| Cutler-Hammer | EDC     |  | •                           |                             |                   |                                |                                    | •                    |                               |                 |              |                     |                      |                                |
| Cutler-Hammer | EDH     |  | •                           |                             |                   |                                |                                    | •                    |                               |                 |              |                     |                      |                                |
| Cutler-Hammer | EFH     |  | •                           |                             |                   |                                |                                    | •                    |                               |                 |              |                     |                      |                                |
| Cutler-Hammer | EGB     |  | •                           |                             |                   |                                |                                    | •                    |                               |                 |              |                     |                      |                                |
| Cutler-Hammer | EGE     |  | •                           |                             |                   |                                |                                    | •                    |                               |                 |              |                     |                      |                                |
| Cutler-Hammer | EGS     |  | •                           |                             |                   |                                |                                    | •                    |                               |                 |              |                     |                      |                                |
| Cutler-Hammer | EHC     |  | •                           |                             |                   |                                |                                    | •                    |                               |                 |              |                     |                      |                                |
| Cutler-Hammer | EHD     |  | •                           |                             |                   |                                |                                    | •                    |                               |                 |              |                     |                      |                                |
| Cutler-Hammer | FB      |  | •                           |                             |                   |                                |                                    | •                    |                               |                 |              |                     |                      |                                |
| Cutler-Hammer | FC      |  | •                           |                             |                   |                                |                                    | •                    |                               |                 |              |                     |                      |                                |
| Cutler-Hammer | FD      |  | •                           |                             |                   |                                |                                    | •                    |                               |                 |              |                     |                      |                                |
| Cutler-Hammer | FDB     |  | •                           |                             |                   |                                |                                    | •                    |                               |                 |              |                     |                      |                                |
| Cutler-Hammer | FDC     |  | •                           |                             |                   |                                |                                    | •                    |                               |                 |              |                     |                      |                                |
| Cutler-Hammer | FS      |  | •                           |                             |                   |                                |                                    | •                    |                               |                 |              |                     |                      |                                |
| Cutler-Hammer | GB      |  | •                           |                             |                   |                                |                                    | •                    |                               |                 |              |                     |                      |                                |
| Cutler-Hammer | GC      |  | •                           |                             |                   |                                |                                    | •                    |                               |                 |              |                     |                      |                                |
| Cutler-Hammer | GD      |  | •                           |                             |                   |                                |                                    | •                    |                               |                 |              |                     |                      |                                |
| Cutler-Hammer | GDB     |  | •                           |                             |                   |                                |                                    | •                    |                               |                 |              |                     |                      |                                |
| Cutler-Hammer | GHB     |  | •                           |                             |                   |                                |                                    | •                    |                               |                 |              |                     |                      |                                |
| Cutler-Hammer | GHBGFEP |  | •                           |                             |                   |                                |                                    | •                    |                               |                 |              |                     |                      |                                |
| Cutler-Hammer | GHC     |  | •                           |                             |                   |                                |                                    | •                    |                               |                 |              |                     |                      |                                |
| Cutler-Hammer | GHCGFEP |  | •                           |                             |                   |                                |                                    | •                    |                               |                 |              |                     |                      |                                |
| Cutler-Hammer | HBAW    | •  | •                           |                             |                   |                                |                                    | •                    |                               |                 |              |                     |                      |                                |
| Cutler-Hammer | HBAW    |  |                             |                             |                   | •                              |                                    |                      |                               |                 |              |                     |                      |                                |
| Cutler-Hammer | HBAX    | •  | •                           |                             |                   |                                |                                    | •                    |                               |                 |              |                     |                      |                                |
| Cutler-Hammer | HBAX    |  |                             |                             |                   | •                              |                                    |                      |                               |                 |              |                     |                      |                                |
| Cutler-Hammer | HFD     |  | •                           |                             |                   |                                |                                    | •                    |                               |                 |              |                     |                      |                                |
| Cutler-Hammer | HGHB    |  | •                           |                             |                   |                                |                                    | •                    |                               |                 |              |                     |                      |                                |
| Cutler-Hammer | HGHC    |  | •                           |                             |                   |                                |                                    | •                    |                               |                 |              |                     |                      |                                |
| Cutler-Hammer | HJD     |  |                             | •                           |                   |                                |                                    |                      |                               |                 |              |                     |                      |                                |
| Cutler-Hammer | HKD     |  |                             | •                           |                   |                                |                                    |                      |                               |                 |              |                     |                      |                                |
| Cutler-Hammer | HLD     |  |                             |                             | •                 |                                |                                    |                      |                               |                 |              |                     |                      |                                |
| Cutler-Hammer | HMCP    |  | •                           | •                           | •                 |                                |                                    |                      |                               |                 |              |                     |                      |                                |
| Cutler-Hammer | HMDL    |  |                             |                             | •                 |                                |                                    |                      |                               |                 |              |                     |                      |                                |
| Cutler-Hammer | HMDLB   |  |                             |                             | •                 |                                |                                    |                      |                               |                 |              |                     |                      |                                |
| Cutler-Hammer | HMPL    |  |                             | •**                         | •                 |                                |                                    |                      |                               |                 |              |                     |                      |                                |
| Cutler-Hammer | HND     |  |                             | •**                         |                   |                                |                                    |                      |                               |                 |              |                     |                      |                                |
| Cutler-Hammer | HQP     | •  | •                           |                             |                   |                                |                                    | •                    |                               |                 |              |                     |                      |                                |
| Cutler-Hammer | HQP     |  |                             |                             |                   | •                              |                                    |                      |                               |                 |              |                     |                      |                                |
| Cutler-Hammer | JD      |  |                             |                             |                   |                                |                                    |                      |                               |                 |              |                     |                      |                                |
| Cutler-Hammer | JDB     |  |                             | •                           |                   |                                |                                    |                      |                               |                 |              |                     |                      |                                |
| Cutler-Hammer | JDC     |  |                             | •                           |                   |                                |                                    |                      |                               |                 |              |                     |                      |                                |
| Cutler-Hammer | KD      |  |                             | •                           |                   |                                |                                    |                      |                               |                 |              |                     |                      |                                |
| Cutler-Hammer | KDB     |  |                             | •                           |                   |                                |                                    |                      |                               |                 |              |                     |                      |                                |
| Cutler-Hammer | KDC     |  |                             | •                           |                   |                                |                                    |                      |                               |                 |              |                     |                      |                                |
| Cutler-Hammer | LA      |  |                             | •                           |                   |                                |                                    |                      |                               |                 |              |                     |                      |                                |
| Cutler-Hammer | LD      |  |                             |                             | •                 |                                |                                    |                      |                               |                 |              |                     |                      |                                |
| Cutler-Hammer | LDB     |  |                             |                             | •                 |                                |                                    |                      |                               |                 |              |                     |                      |                                |
| Cutler-Hammer | LDC     |  |                             |                             | •                 |                                |                                    |                      |                               |                 |              |                     |                      |                                |
| Cutler-Hammer | LH      |  |                             | •                           |                   |                                |                                    |                      |                               |                 |              |                     |                      |                                |
| Cutler-Hammer | LHB     |  |                             | •                           |                   |                                |                                    |                      |                               |                 |              |                     |                      |                                |
| Cutler-Hammer | LJ      |  |                             |                             |                   |                                |                                    | •                    |                               |                 |              |                     |                      |                                |
| Cutler-Hammer | MA      |  |                             | •**                         |                   |                                |                                    |                      |                               |                 |              |                     |                      |                                |
| Cutler-Hammer | MC      |  |                             | •**                         |                   |                                |                                    |                      |                               |                 |              |                     |                      |                                |
| Cutler-Hammer | MD      |  |                             |                             | •                 |                                |                                    |                      |                               |                 |              |                     |                      |                                |
| Cutler-Hammer | MDL     |  |                             |                             | •                 |                                |                                    |                      |                               |                 |              |                     |                      |                                |
| Cutler-Hammer | MDS     |  |                             |                             | •                 |                                |                                    |                      |                               |                 |              |                     |                      |                                |
| Cutler-Hammer | NB      |  |                             |                             | •                 |                                |                                    |                      |                               |                 |              |                     |                      |                                |
| Cutler-Hammer | ND      |  |                             | •**                         |                   |                                |                                    |                      |                               |                 |              |                     |                      |                                |
| Cutler-Hammer | NDC     |  |                             | •**                         |                   |                                |                                    |                      |                               |                 |              |                     |                      |                                |
| Cutler-Hammer | OPTIM   |  |                             | •**                         |                   |                                |                                    |                      |                               |                 |              |                     |                      |                                |

\* - Cleat (065404) accessory required    \*\* - Cleat (065406) accessory required

# Breaker compatibility overview

- i See page...**
- Standard Circuit Breaker: 56-57
  - EZ Panel Loc™: 54
  - Mini Circuit Breaker Lockouts: 54

|                    |            | Circuit Breaker Lockout (Standard/ TAGLOCK™) |                             |                             |                   | EZ Panel Loc™ (Standard/ TAGLOCK™) |                  | Mini Circuit Breaker Lockouts |                  |                 |              |                     |                      |                                |
|--------------------|------------|--|-----------------------------|-----------------------------|-------------------|------------------------------------|------------------|-------------------------------|------------------|-----------------|--------------|---------------------|----------------------|--------------------------------|
| Manufacturer       | Type       | 120V Snap On (w/ hole)                       | 120/277V Clamp On (no hole) | 480/600V Clamp On (no hole) | Oversize 480/600V | Universal Multi-pole (tie bar)     | Snap On (SQD QO) | Clamp On (Universal)          | Pin Out Standard | Pin In Standard | Pin Out Wide | Pin Out Wide Rotary | Multi-pole w/ TieBar | Universal Mini Breaker Lockout |
|                    |            | 065387                                       | 065396                      | 065397                      | 065329            | 066321                             | 051252           | 051254                        | 090844           | 090847          | 090850       | 149433              | 090853               | 149514                         |
|                    |            | 148689                                       | 148690                      | 148701                      | 148692            | 148702                             | 148696           |                               |                  |                 |              |                     |                      |                                |
|                    |            | 148693                                       | 148698                      | 148687                      | 148691            | 148697                             | 148688           |                               |                  |                 |              |                     |                      |                                |
|                    |            | 148694                                       | 148699                      | 148686                      | 148685            | 148695                             | 148700           |                               |                  |                 |              |                     |                      |                                |
| Cutler-Hammer      | PB         |  |                             |                             |                   |                                    |                  |                               |                  |                 |              |                     |                      |                                |
| Cutler-Hammer      | QBGF       |  | •                           |                             |                   |                                    |                  |                               |                  |                 |              |                     |                      |                                |
| Cutler-Hammer      | QBGF       |  |                             |                             |                   |                                    |                  |                               |                  |                 |              |                     |                      |                                |
| Cutler-Hammer      | QBGFEP     |  | •                           |                             |                   |                                    |                  |                               |                  |                 |              |                     |                      |                                |
| Cutler-Hammer      | QBGFEP     |  |                             |                             |                   |                                    |                  |                               |                  |                 |              |                     |                      |                                |
| Cutler-Hammer      | QBHGF      |  | •                           |                             |                   |                                    |                  |                               |                  |                 |              |                     |                      |                                |
| Cutler-Hammer      | QBHGFEP    |  | •                           |                             |                   |                                    |                  |                               |                  |                 |              |                     |                      |                                |
| Cutler-Hammer      | QBHW       | •  | •                           |                             |                   |                                    |                  | •                             |                  |                 |              |                     |                      |                                |
| Cutler-Hammer      | QBHW       |  |                             |                             |                   | •                                  |                  |                               |                  |                 |              |                     |                      |                                |
| Cutler-Hammer      | QC         | •  | •                           |                             |                   |                                    |                  |                               |                  |                 |              |                     |                      |                                |
| Cutler-Hammer      | QC         |  |                             |                             |                   | •                                  |                  |                               |                  |                 |              |                     |                      |                                |
| Cutler-Hammer      | QCD        | •  | •                           |                             |                   |                                    |                  |                               |                  |                 |              |                     |                      |                                |
| Cutler-Hammer      | QCD        |  |                             |                             |                   | •                                  |                  |                               |                  |                 |              |                     |                      |                                |
| Cutler-Hammer      | QCGF       |  | •                           |                             |                   |                                    |                  |                               |                  |                 |              |                     |                      |                                |
| Cutler-Hammer      | QCGFEP     |  | •                           |                             |                   |                                    |                  |                               |                  |                 |              |                     |                      |                                |
| Cutler-Hammer      | QCHGF      |  | •                           |                             |                   |                                    |                  |                               |                  |                 |              |                     |                      |                                |
| Cutler-Hammer      | QCHGFEP    |  | •                           |                             |                   |                                    |                  |                               |                  |                 |              |                     |                      |                                |
| Cutler-Hammer      | QCHW       | •  | •                           |                             |                   |                                    |                  |                               |                  |                 |              |                     |                      |                                |
| Cutler-Hammer      | QCHW       |  |                             |                             |                   | •                                  |                  |                               |                  |                 |              |                     |                      |                                |
| Cutler-Hammer      | QHCW       | •  | •                           |                             |                   |                                    |                  |                               |                  |                 |              |                     |                      |                                |
| Cutler-Hammer      | QHCW       |  |                             |                             |                   | •                                  |                  |                               |                  |                 |              |                     |                      |                                |
| Cutler-Hammer      | QHCX       | •  | •                           |                             |                   |                                    |                  |                               |                  |                 |              |                     |                      |                                |
| Cutler-Hammer      | QHCX       |  |                             |                             |                   | •                                  |                  |                               |                  |                 |              |                     |                      |                                |
| Cutler-Hammer      | QHPW       | •  | •                           |                             |                   |                                    |                  |                               |                  |                 |              |                     |                      |                                |
| Cutler-Hammer      | QHPW       |  |                             |                             |                   | •                                  |                  |                               |                  |                 |              |                     |                      |                                |
| Cutler-Hammer      | QHPX       | •  | •                           |                             |                   |                                    |                  |                               |                  |                 |              |                     |                      |                                |
| Cutler-Hammer      | QHPX       |  |                             |                             |                   | •                                  |                  |                               |                  |                 |              |                     |                      |                                |
| Cutler-Hammer      | QPGF       |  | •                           |                             |                   |                                    |                  |                               |                  |                 |              |                     |                      |                                |
| Cutler-Hammer      | QPGF       |  |                             |                             |                   |                                    |                  |                               |                  |                 |              |                     |                      |                                |
| Cutler-Hammer      | QPGFEP     |  | •                           |                             |                   |                                    |                  |                               |                  |                 |              |                     |                      |                                |
| Cutler-Hammer      | QPGFEP     |  |                             |                             |                   |                                    |                  |                               |                  |                 |              |                     |                      |                                |
| Cutler-Hammer      | QPHGF      |  | •                           |                             |                   |                                    |                  |                               |                  |                 |              |                     |                      |                                |
| Cutler-Hammer      | QPHGFEP    |  | •                           |                             |                   |                                    |                  |                               |                  |                 |              |                     |                      |                                |
| Cutler-Hammer      | QPHW       | •  | •                           |                             |                   |                                    |                  |                               |                  |                 |              |                     |                      |                                |
| Cutler-Hammer      | QPHW       |  |                             |                             |                   | •                                  |                  |                               |                  |                 |              |                     |                      |                                |
| Cutler-Hammer      | WME        |  |                             |                             |                   |                                    |                  |                               |                  | •               |              |                     |                      |                                |
| Cutler-Hammer      | WMF        |  |                             |                             |                   |                                    |                  |                               |                  | •               |              |                     |                      |                                |
| Cutler-Hammer      | WMH        |  |                             |                             |                   |                                    |                  |                               |                  | •               |              |                     |                      |                                |
| Cutler-Hammer      | WMM        |  |                             |                             |                   |                                    |                  |                               |                  | •               |              |                     |                      |                                |
| Cutler-Hammer      | WMN        |  |                             |                             |                   |                                    |                  |                               |                  | •               |              |                     |                      |                                |
| Cutler-Hammer      | WMS        |  |                             |                             |                   |                                    |                  |                               |                  | •               |              |                     |                      |                                |
| E-T-A              | 911220G    |  |                             |                             |                   |                                    |                  |                               |                  | •               |              |                     |                      |                                |
| E-T-A              | 911225     |  |                             |                             |                   |                                    |                  |                               |                  |                 | •            |                     |                      |                                |
| FAZ                | C16        |  |                             |                             |                   |                                    |                  |                               |                  | •               |              |                     |                      |                                |
| Fed. Pacific Elec. | 2B         |  |                             |                             |                   |                                    |                  |                               |                  |                 |              |                     |                      |                                |
| Fed. Pacific Elec. | BAB        |  | •                           |                             |                   |                                    |                  |                               |                  |                 |              |                     |                      |                                |
| Fed. Pacific Elec. | NA-single  |  |                             | •**                         |                   |                                    |                  |                               |                  |                 |              |                     |                      |                                |
| Fed. Pacific Elec. | NA-tie bar |  |                             |                             |                   |                                    |                  |                               |                  |                 |              |                     |                      |                                |
| Fed. Pacific Elec. | NB         |  | •*                          |                             |                   |                                    |                  |                               |                  |                 |              |                     |                      |                                |
| Fed. Pacific Elec. | NBH GFI    |  | •                           |                             |                   |                                    |                  |                               |                  |                 |              |                     |                      |                                |
| Fed. Pacific Elec. | NE/NEF     |  | •*                          |                             |                   |                                    |                  |                               |                  |                 |              |                     |                      |                                |
| Fed. Pacific Elec. | NEJ        |  | •*                          |                             |                   |                                    |                  |                               |                  |                 |              |                     |                      |                                |
| Fed. Pacific Elec. | NFJ        |  | •                           |                             |                   |                                    |                  |                               |                  |                 |              |                     |                      |                                |
| Fed. Pacific Elec. | NJJ        |  |                             | •                           |                   |                                    |                  |                               |                  |                 |              |                     |                      |                                |
| Fed. Pacific Elec. | NJL        |  |                             | •                           |                   |                                    |                  |                               |                  |                 |              |                     |                      |                                |
| Fed. Pacific Elec. | NM         |  |                             | •                           |                   |                                    |                  |                               |                  |                 |              |                     |                      |                                |
| Fed. Pacific Elec. | NP-single  |  | •                           |                             |                   |                                    |                  |                               |                  |                 |              |                     |                      |                                |
| Frank Adams        | P          |  | •                           |                             |                   |                                    |                  |                               |                  |                 |              |                     |                      |                                |
| FUJI Electric      | EA53B      |  | •*                          |                             |                   |                                    |                  |                               |                  |                 |              |                     |                      |                                |
| FUJI Electric      | EA203B     |  | •*                          |                             |                   |                                    |                  |                               |                  |                 |              |                     |                      |                                |
| FUJI Electric      | BU-ESB     |  | •*                          |                             |                   |                                    |                  |                               |                  |                 |              |                     |                      |                                |
| FUJI Electric      | BU-ESA     |  | •*                          |                             |                   |                                    |                  |                               |                  |                 |              |                     |                      |                                |
| FUJI Electric      | BU-FSB     |  | •*                          |                             |                   |                                    |                  |                               |                  |                 |              |                     |                      |                                |
| General Electric   | V          |  |                             |                             |                   |                                    |                  |                               |                  |                 |              |                     |                      |                                |
| General Electric   | EH400      |  |                             | •                           |                   |                                    |                  |                               |                  |                 |              | •                   |                      |                                |
| General Electric   | HQC        |  | •                           |                             |                   |                                    |                  |                               |                  |                 |              |                     |                      |                                |
| General Electric   | SED        |  | •                           |                             |                   |                                    |                  |                               |                  |                 |              |                     |                      |                                |
| General Electric   | SEH        |  | •                           |                             |                   |                                    |                  |                               |                  |                 |              |                     |                      |                                |
| General Electric   | SEL        |  | •                           |                             |                   |                                    |                  |                               |                  |                 |              |                     |                      |                                |
| General Electric   | SEP        |  | •                           |                             |                   |                                    |                  |                               |                  |                 |              |                     |                      |                                |
| General Electric   | SFH        |  | •                           |                             |                   |                                    |                  |                               |                  |                 |              |                     |                      |                                |
| General Electric   | SFL        |  | •                           |                             |                   |                                    |                  |                               |                  |                 |              |                     |                      |                                |
| General Electric   | SFP        |  | •                           |                             |                   |                                    |                  |                               |                  |                 |              |                     |                      |                                |
| General Electric   | SGD        |  |                             | •                           |                   |                                    |                  |                               |                  |                 |              |                     |                      |                                |
| General Electric   | SGH        |  |                             | •                           |                   |                                    |                  |                               |                  |                 |              |                     |                      |                                |
| General Electric   | SGL        |  |                             | •                           |                   |                                    |                  |                               |                  |                 |              |                     |                      |                                |
| General Electric   | SGLA       |  |                             | •                           |                   |                                    |                  |                               |                  |                 |              |                     |                      |                                |
| General Electric   | SGP        |  |                             | •                           |                   |                                    |                  |                               |                  |                 |              |                     |                      |                                |
| General Electric   | SRPG       |  |                             | •                           |                   |                                    |                  |                               |                  |                 |              |                     |                      |                                |
| General Electric   | TB         |  | •*                          |                             |                   |                                    |                  |                               |                  |                 |              |                     |                      |                                |
| General Electric   | TBC        |  | •*                          |                             |                   |                                    |                  |                               |                  |                 |              |                     |                      |                                |

\* - Cleat (065404) accessory required    \*\* - Cleat (065406) accessory required

# Breaker compatibility overview

**i See page...**

- Standard Circuit Breaker: 56-57
- EZ Panel Loc™: 54
- Mini Circuit Breaker Lockouts: 54

| Manufacturer     |          | Circuit Breaker Lockout (Standard/ TAGLOCK™) |                             |                             |                   |                                | EZ Panel Loc™ (Standard/ TAGLOCK™) |                      | Mini Circuit Breaker Lockouts |                 |              |                     |                      |                                |
|------------------|----------|--|-----------------------------|-----------------------------|-------------------|--------------------------------|------------------------------------|----------------------|-------------------------------|-----------------|--------------|---------------------|----------------------|--------------------------------|
|                  |          | 120V Snap On (w/ hole)                       | 120/277V Clamp On (no hole) | 480/600V Clamp On (no hole) | Oversize 480/600V | Universal Multi-pole (tie bar) | Snap On (SQD QO)                   | Clamp On (Universal) | Pin Out Standard              | Pin In Standard | Pin Out Wide | Pin Out Wide Rotary | Multi-pole w/ TieBar | Universal Mini Breaker Lockout |
|                  |          | 065387                                       | 065396                      | 065397                      | 065329            | 066321                         | 051252                             | 051254               | 090844                        | 090847          | 090850       | 149433              | 090853               | 149514                         |
|                  |          | 148689                                       | 148690                      | 148701                      | 148692            | 148702                         | 148696                             |                      |                               |                 |              |                     |                      |                                |
|                  |          | 148693                                       | 148698                      | 148687                      | 148691            | 148697                         | 148688                             |                      |                               |                 |              |                     |                      |                                |
|                  |          | 148694                                       | 148699                      | 148686                      | 148665            | 148695                         | 148700                             |                      |                               |                 |              |                     |                      |                                |
| General Electric | TE       |  | •*                          |                             |                   |                                |                                    | •                    |                               |                 |              |                     |                      |                                |
| General Electric | TEB      |  | •*                          |                             |                   |                                |                                    | •                    |                               |                 |              |                     |                      |                                |
| General Electric | TED      |  | •*                          |                             |                   |                                |                                    | •                    |                               |                 |              |                     |                      |                                |
| General Electric | TEF      |  | •*                          |                             |                   |                                |                                    | •                    |                               |                 |              |                     |                      |                                |
| General Electric | TEL      |  | •*                          |                             |                   |                                |                                    | •                    |                               |                 |              |                     |                      |                                |
| General Electric | TEML     |  | •*                          |                             |                   |                                |                                    | •                    |                               |                 |              |                     |                      |                                |
| General Electric | TEY      |  | •                           |                             |                   |                                |                                    | •                    |                               |                 |              |                     |                      |                                |
| General Electric | TF       |  | •                           |                             |                   |                                |                                    | •                    |                               |                 |              |                     |                      |                                |
| General Electric | TFC      |  | •*                          |                             |                   |                                |                                    | •                    |                               |                 |              |                     |                      |                                |
| General Electric | TFJ      |  |                             | •                           |                   |                                |                                    |                      |                               |                 |              |                     |                      |                                |
| General Electric | TFK      |  |                             | •                           |                   |                                |                                    |                      |                               |                 |              |                     |                      |                                |
| General Electric | TFL      |  |                             | •                           |                   |                                |                                    |                      |                               |                 |              |                     |                      |                                |
| General Electric | THED     |  | •*                          |                             |                   |                                |                                    | •                    |                               |                 |              |                     |                      |                                |
| General Electric | THEF     |  | •*                          |                             |                   |                                |                                    | •                    |                               |                 |              |                     |                      |                                |
| General Electric | THFK     |  |                             | •                           |                   |                                |                                    |                      |                               |                 |              |                     |                      |                                |
| General Electric | THHQB    |  |                             |                             |                   | •                              |                                    | •                    |                               |                 |              |                     |                      |                                |
| General Electric | THHQB-A  | •  | •                           |                             |                   |                                |                                    | •                    |                               |                 |              |                     |                      |                                |
| General Electric | THHQB-S  |  | •                           |                             |                   |                                |                                    | •                    |                               |                 |              |                     |                      |                                |
| General Electric | THHQC    |  |                             |                             |                   | •                              |                                    | •                    |                               |                 |              |                     |                      |                                |
| General Electric | THHQC-A  | •  | •                           |                             |                   |                                |                                    | •                    |                               |                 |              |                     |                      |                                |
| General Electric | THHQC-S  |  | •                           |                             |                   |                                |                                    | •                    |                               |                 |              |                     |                      |                                |
| General Electric | THHQL    |  |                             |                             |                   | •                              |                                    | •                    |                               |                 |              |                     |                      |                                |
| General Electric | THHQL-A  | •  | •                           |                             |                   |                                |                                    | •                    |                               |                 |              |                     |                      |                                |
| General Electric | THHQL-S  |  | •                           |                             |                   |                                |                                    | •                    |                               |                 |              |                     |                      |                                |
| General Electric | THJK4    |  |                             | •**                         |                   |                                |                                    |                      |                               |                 |              |                     |                      |                                |
| General Electric | THJK6    |  |                             | •**                         |                   |                                |                                    |                      |                               |                 |              |                     |                      |                                |
| General Electric | THKM12   |  |                             |                             | •                 |                                |                                    |                      |                               |                 |              |                     |                      |                                |
| General Electric | THKM8    |  |                             |                             | •                 |                                |                                    |                      |                               |                 |              |                     |                      |                                |
| General Electric | THLC1    |  | •*                          |                             |                   |                                |                                    |                      |                               |                 |              |                     |                      |                                |
| General Electric | THQB     |  |                             |                             |                   | •                              |                                    | •                    |                               |                 |              |                     |                      |                                |
| General Electric | THQB GF  |  |                             |                             |                   |                                |                                    |                      |                               |                 |              |                     |                      |                                |
| General Electric | THQB-A   | •  | •                           |                             |                   |                                |                                    | •                    |                               |                 |              |                     |                      |                                |
| General Electric | THQB-S   |  | •                           |                             |                   |                                |                                    | •                    |                               |                 |              |                     |                      |                                |
| General Electric | THQC     |  |                             |                             |                   | •                              |                                    | •                    |                               |                 |              |                     |                      |                                |
| General Electric | THQC-A   | •  | •                           |                             |                   |                                |                                    | •                    |                               |                 |              |                     |                      |                                |
| General Electric | THQC-AL  |  |                             |                             |                   | •                              |                                    | •                    |                               |                 |              |                     |                      |                                |
| General Electric | THQC-S   |  | •                           |                             |                   |                                |                                    | •                    |                               |                 |              |                     |                      |                                |
| General Electric | THQD     |  | •*                          |                             |                   |                                |                                    | •                    |                               |                 |              |                     |                      |                                |
| General Electric | THQDBL   |  |                             |                             |                   |                                |                                    | •                    |                               |                 |              |                     |                      |                                |
| General Electric | THQL     |  |                             |                             |                   | •                              |                                    | •                    |                               |                 |              |                     |                      |                                |
| General Electric | THQL-A   | •  | •                           |                             |                   |                                |                                    | •                    |                               |                 |              |                     |                      |                                |
| General Electric | THQL-S   |  | •                           |                             |                   |                                |                                    | •                    |                               |                 |              |                     |                      |                                |
| General Electric | TJ2      |  |                             | •**                         | •                 |                                |                                    |                      |                               |                 |              |                     |                      |                                |
| General Electric | TJ4      |  |                             | •                           |                   |                                |                                    |                      |                               |                 |              |                     |                      |                                |
| General Electric | TJC      |  | •*                          |                             |                   |                                |                                    | •                    |                               |                 |              |                     |                      |                                |
| General Electric | TJD      |  |                             | •**                         |                   |                                |                                    |                      |                               |                 |              |                     |                      |                                |
| General Electric | TJJ      |  |                             | •**                         |                   |                                |                                    |                      |                               |                 |              |                     |                      |                                |
| General Electric | TJK      |  |                             | •**                         |                   |                                |                                    |                      |                               |                 |              |                     |                      |                                |
| General Electric | TJS      |  |                             | •**                         |                   |                                |                                    |                      |                               |                 |              |                     |                      |                                |
| General Electric | TK4V     |  |                             | •                           |                   |                                |                                    |                      |                               |                 |              |                     |                      |                                |
| General Electric | TKC      |  | •*                          |                             |                   |                                |                                    | •                    |                               |                 |              |                     |                      |                                |
| General Electric | TKM      |  |                             |                             | •                 |                                |                                    |                      |                               |                 |              |                     |                      |                                |
| General Electric | TKMA8    |  |                             |                             | •                 |                                |                                    |                      |                               |                 |              |                     |                      |                                |
| General Electric | TQB      |  |                             |                             |                   | •                              |                                    | •                    |                               |                 |              |                     |                      |                                |
| General Electric | TQB-A    | •  | •                           |                             |                   |                                |                                    | •                    |                               |                 |              |                     |                      |                                |
| General Electric | TQB-S    |  | •                           |                             |                   |                                |                                    | •                    |                               |                 |              |                     |                      |                                |
| General Electric | TQC      |  |                             |                             |                   | •                              |                                    | •                    |                               |                 |              |                     |                      |                                |
| General Electric | TQC-A    | •  | •                           |                             |                   |                                |                                    | •                    |                               |                 |              |                     |                      |                                |
| General Electric | TQC-S    |  | •                           |                             |                   |                                |                                    | •                    |                               |                 |              |                     |                      |                                |
| General Electric | TQD      |  | •                           |                             |                   |                                |                                    |                      |                               |                 |              |                     |                      |                                |
| General Electric | TQL      |  |                             |                             |                   |                                |                                    |                      |                               |                 |              |                     |                      |                                |
| General Electric | TQL      |  |                             |                             |                   |                                |                                    |                      |                               |                 |              |                     |                      |                                |
| General Electric | TQL-A    | •  | •                           |                             |                   |                                |                                    | •                    |                               |                 |              |                     |                      |                                |
| General Electric | TQL-S    |  | •                           |                             |                   |                                |                                    | •                    |                               |                 |              |                     |                      |                                |
| General Electric | V        |  |                             |                             |                   |                                |                                    |                      |                               |                 | •            |                     |                      |                                |
| GE Vynckier      | Series E |  |                             |                             |                   |                                |                                    |                      |                               |                 | •            |                     |                      |                                |
| GE Vynckier      | Series G |  |                             |                             |                   |                                |                                    |                      |                               |                 | •            |                     |                      |                                |
| Hager            | MFN716   |  |                             |                             |                   |                                |                                    |                      |                               |                 |              |                     |                      | •                              |
| Hager            | 453717   |  |                             |                             |                   |                                |                                    |                      | •                             |                 |              |                     |                      |                                |
| Hager            | MW216A   |  |                             |                             |                   |                                |                                    |                      | •                             |                 |              |                     |                      |                                |
| Hager            | MW620A   |  |                             |                             |                   |                                |                                    |                      | •                             |                 |              |                     |                      |                                |
| Hager            | H125N    |  | •                           |                             |                   |                                |                                    |                      |                               |                 |              |                     |                      |                                |
| Hager            | H250N    |  | •                           |                             |                   |                                |                                    |                      |                               |                 |              |                     |                      |                                |
| Hager            | H400XS   |  |                             | •                           |                   |                                |                                    |                      |                               |                 |              |                     |                      |                                |
| Hager            | H630XS   |  |                             | •                           |                   |                                |                                    |                      |                               |                 |              |                     |                      |                                |
| Heinemann        | LB       |  | •*                          |                             |                   |                                |                                    |                      |                               |                 |              |                     |                      |                                |
| Heinemann        | LF       |  | •*                          |                             |                   |                                |                                    |                      |                               |                 |              |                     |                      |                                |
| Heinemann        | LJ       |  | •*                          |                             |                   |                                |                                    |                      |                               |                 |              |                     |                      |                                |
| Kapp             | LS68     |  |                             |                             |                   |                                |                                    |                      |                               |                 | •            |                     |                      |                                |
| Legrand          | 04302    |  |                             |                             |                   |                                |                                    |                      |                               |                 | •            |                     |                      |                                |
| Legrand          | 06469    |  |                             |                             |                   |                                |                                    |                      |                               |                 | •            |                     |                      |                                |

\* - Cleat (065404) accessory required    \*\* - Cleat (065406) accessory required



# Breaker compatibility overview

**i See page...**

- Standard Circuit Breaker: 56-57
- EZ Panel Loc™: 54
- Mini Circuit Breaker Lockouts: 54

|              |          | Circuit Breaker Lockout (Standard/ TAGLOCK™)              |   |   |   |   | EZ Panel Loc™ (Standard/ TAGLOCK™)                        |                      | Mini Circuit Breaker Lockouts |                 |              |                     |                      |                                |
|--------------|----------|---|---|---|---|---|---|----------------------|-------------------------------|-----------------|--------------|---------------------|----------------------|--------------------------------|
| Manufacturer | Type     | 120V Snap On (w/ hole)                                    | 120/277V Clamp On (no hole)                               | 480/600V Clamp On (no hole)                               | Oversize 480/600V   | Universal Multi-pole (tie bar)                            | Snap On (SQD QO)  | Clamp On (Universal) | Pin Out Standard              | Pin In Standard | Pin Out Wide | Pin Out Wide Rotary | Multi-pole w/ TieBar | Universal Mini Breaker Lockout |
|              |          | 065387<br><i>148689</i><br><i>148693</i><br><i>148694</i> | 065396<br><i>148690</i><br><i>148698</i><br><i>148699</i> | 065397<br><i>148701</i><br><i>148687</i><br><i>148686</i> | 065329<br><i>148692</i><br><i>148691</i><br><i>148665</i> | 066321<br><i>148702</i><br><i>148697</i><br><i>148695</i> | 051252<br><i>148696</i><br><i>148688</i><br><i>148700</i> | 051254               | 090844                        | 090847          | 090850       | 149433              | 090853               | 149514                         |
| Siemens ITE  | HBQ      | •   | •   |   |   |   |   |                      |                               |                 |              |                     |                      |                                |
| Siemens ITE  | HBQ      |   |   |   |   | •   |   |                      |                               |                 |              |                     |                      |                                |
| Siemens ITE  | HE4      |   | •   |   |   |   |   |                      |                               |                 |              |                     |                      |                                |
| Siemens ITE  | HED4     |   | •   |   |   |   |   |                      |                               |                 |              |                     |                      |                                |
| Siemens ITE  | HED6     |   | •   |   |   |   |   |                      |                               |                 |              |                     |                      |                                |
| Siemens ITE  | HFD6     |   |   | •**   |   |   |   |                      |                               |                 |              |                     |                      |                                |
| Siemens ITE  | HFXD6    |   |   | •**   |   |   |   |                      |                               |                 |              |                     |                      |                                |
| Siemens ITE  | HHED6    |   | •   |   |   |   |   |                      |                               |                 |              |                     |                      |                                |
| Siemens ITE  | HHFD6    |   |   | •**   |   |   |   |                      |                               |                 |              |                     |                      |                                |
| Siemens ITE  | HHJD6    |   |   | •   |   |   |   |                      |                               |                 |              |                     |                      |                                |
| Siemens ITE  | HHJXD6   |   |   | •   |   |   |   |                      |                               |                 |              |                     |                      |                                |
| Siemens ITE  | HJD6     |   |   | •   |   |   |   |                      |                               |                 |              |                     |                      |                                |
| Siemens ITE  | HJXD6    |   |   | •   |   |   |   |                      |                               |                 |              |                     |                      |                                |
| Siemens ITE  | HMD6     |   |   |   | •   |   |   |                      |                               |                 |              |                     |                      |                                |
| Siemens ITE  | HMXD6    |   |   |   | •   |   |   |                      |                               |                 |              |                     |                      |                                |
| Siemens ITE  | HN3      |   |   |   | •   |   |   |                      |                               |                 |              |                     |                      |                                |
| Siemens ITE  | HND6     |   |   |   | •   |   |   |                      |                               |                 |              |                     |                      |                                |
| Siemens ITE  | HNXD6    |   |   |   | •   |   |   |                      |                               |                 |              |                     |                      |                                |
| Siemens ITE  | HPD6     |   |   |   | •   |   |   |                      |                               |                 |              |                     |                      |                                |
| Siemens ITE  | HPXD6    |   |   |   | •   |   |   |                      |                               |                 |              |                     |                      |                                |
| Siemens ITE  | HQJ2-H   |   | •   |   |   |   |   |                      |                               |                 |              |                     |                      |                                |
| Siemens ITE  | HQP      | •   | •   |   |   |   |   |                      |                               |                 |              |                     |                      |                                |
| Siemens ITE  | HQP      |   |   |   |   | •   |   |                      |                               |                 |              |                     |                      |                                |
| Siemens ITE  | HQPP     | •   | •   |   |   |   |   |                      |                               |                 |              |                     |                      |                                |
| Siemens ITE  | HQPP     |   |   |   |   | •   |   |                      |                               |                 |              |                     |                      |                                |
| Siemens ITE  | HQPPH    |   |   |   |   | •   |   |                      |                               |                 |              |                     |                      |                                |
| Siemens ITE  | HRD6     |   |   |   | •   |   |   |                      |                               |                 |              |                     |                      |                                |
| Siemens ITE  | HRXD6    |   |   |   | •   |   |   |                      |                               |                 |              |                     |                      |                                |
| Siemens ITE  | JD2      |   |   |   | •   |   |   |                      |                               |                 |              |                     |                      |                                |
| Siemens ITE  | JD6-A    |   |   | •   |   |   |   |                      |                               |                 |              |                     |                      |                                |
| Siemens ITE  | JJ3      |   |   | •   |   |   |   |                      |                               |                 |              |                     |                      |                                |
| Siemens ITE  | JJ6      |   |   |   | •   |   |   |                      |                               |                 |              |                     |                      |                                |
| Siemens ITE  | JL3      |   |   | •   |   |   |   |                      |                               |                 |              |                     |                      |                                |
| Siemens ITE  | JXD2-A   |   |   | •   |   |   |   |                      |                               |                 |              |                     |                      |                                |
| Siemens ITE  | JXD6-A   |   |   |   | •   |   |   |                      |                               |                 |              |                     |                      |                                |
| Siemens ITE  | KM3      |   |   |   | •   |   |   |                      |                               |                 |              |                     |                      |                                |
| Siemens ITE  | LL3      |   |   | •   |   |   |   |                      |                               |                 |              |                     |                      |                                |
| Siemens ITE  | LL6      |   |   |   | •   |   |   |                      |                               |                 |              |                     |                      |                                |
| Siemens ITE  | LXD6-ETI |   |   |   | •   |   |   |                      |                               |                 |              |                     |                      |                                |
| Siemens ITE  | MD6      |   |   |   | •   |   |   |                      |                               |                 |              |                     |                      |                                |
| Siemens ITE  | MXD6     |   |   |   | •   |   |   |                      |                               |                 |              |                     |                      |                                |
| Siemens ITE  | MXD6-ETI |   |   |   | •   |   |   |                      |                               |                 |              |                     |                      |                                |
| Siemens ITE  | ND6      |   |   |   | •   |   |   |                      |                               |                 |              |                     |                      |                                |
| Siemens ITE  | NH3-F800 |   |   |   |   |   |   |                      |                               |                 |              |                     |                      |                                |
| Siemens ITE  | NXD6     |   |   |   | •   |   |   |                      |                               |                 |              |                     |                      |                                |
| Siemens ITE  | PD6      |   |   |   | •   |   |   |                      |                               |                 |              |                     |                      |                                |
| Siemens ITE  | PXD6     |   |   |   | •   |   |   |                      |                               |                 |              |                     |                      |                                |
| Siemens ITE  | QJ2      |   | •*  |   |   |   |   |                      |                               |                 |              |                     |                      |                                |
| Siemens ITE  | QJ2-H    |   | •*  |   |   |   |   |                      |                               |                 |              |                     |                      |                                |
| Siemens ITE  | QJH2     |   | •*  |   |   |   |   |                      |                               |                 |              |                     |                      |                                |
| Siemens ITE  | QP       | •   | •   |   |   |   |   |                      |                               |                 |              |                     |                      |                                |
| Siemens ITE  | QP       |   |   |   |   | •   |   |                      |                               |                 |              |                     |                      |                                |
| Siemens ITE  | QP1      |   | •   |   |   |   |   |                      |                               |                 |              |                     |                      |                                |
| Siemens ITE  | QPH      | •   | •   |   |   |   |   |                      |                               |                 |              |                     |                      |                                |
| Siemens ITE  | QPH      |   |   |   |   | •   |   |                      |                               |                 |              |                     |                      |                                |
| Siemens ITE  | QPP      | •   | •   |   |   |   |   |                      |                               |                 |              |                     |                      |                                |
| Siemens ITE  | QPP      |   |   |   |   | •   |   |                      |                               |                 |              |                     |                      |                                |
| Siemens ITE  | QPPH     | •   | •   |   |   |   |   |                      |                               |                 |              |                     |                      |                                |
| Siemens ITE  | QPPH     |   |   |   |   | •   |   |                      |                               |                 |              |                     |                      |                                |
| Siemens ITE  | RD6      |   |   |   | •   |   |   |                      |                               |                 |              |                     |                      |                                |
| Siemens ITE  | RXD6     |   |   |   | •   |   |   |                      |                               |                 |              |                     |                      |                                |
| Siemens ITE  | SCMD6    |   |   |   | •   |   |   |                      |                               |                 |              |                     |                      |                                |
| Siemens ITE  | SCND6    |   |   |   | •   |   |   |                      |                               |                 |              |                     |                      |                                |
| Siemens ITE  | SHLD6-A  |   |   |   | •   |   |   |                      |                               |                 |              |                     |                      |                                |
| Siemens ITE  | SHMD6    |   |   |   | •   |   |   |                      |                               |                 |              |                     |                      |                                |
| Siemens ITE  | SHND6    |   |   |   | •   |   |   |                      |                               |                 |              |                     |                      |                                |
| Siemens ITE  | SMD6     |   |   |   | •   |   |   |                      |                               |                 |              |                     |                      |                                |
| Siemens ITE  | SND6     |   |   |   | •   |   |   |                      |                               |                 |              |                     |                      |                                |
| Siemens ITE  | SHPD6    |   |   |   | •   |   |   |                      |                               |                 |              |                     |                      |                                |
| Siemens ITE  | SPD6     |   |   |   | •   |   |   |                      |                               |                 |              |                     |                      |                                |
| Siemens ITE  | 3VF3     |   | •   |   |   |   |   |                      |                               |                 |              |                     |                      |                                |
| Simplex      | NX       |   |   | •**   |   |   |   |                      |                               |                 |              |                     |                      |                                |
| Square D     | EDB      |   | •   |   |   |   |   |                      |                               |                 |              |                     |                      |                                |
| Square D     | EGB      |   | •   |   |   |   |   |                      |                               |                 |              |                     |                      |                                |
| Square D     | EH4      |   | •   |   |   |   |   |                      |                               |                 |              |                     |                      |                                |
| Square D     | EHB      |   | •   |   |   |   |   |                      |                               |                 |              |                     |                      |                                |
| Square D     | EHB      |   |   |   |   | •   |   |                      |                               |                 |              |                     |                      |                                |
| Square D     | EJB      |   | •   |   |   |   |   |                      |                               |                 |              |                     |                      |                                |
| Square D     | EZ       |   |   |   | •   |   |   |                      |                               |                 |              |                     |                      |                                |
| Square D     | FA       |   | •*  |   |   |   |   |                      |                               |                 |              |                     |                      |                                |
| Square D     | FAL      |   | •*  |   |   |   |   |                      |                               |                 |              |                     |                      |                                |

\* - Cleat (065404) accessory required    \*\* - Cleat (065406) accessory required

# Breaker compatibility overview

**i See page...**

- Standard Circuit Breaker: 56-57
- EZ Panel Loc™: 54
- Mini Circuit Breaker Lockouts: 54

| Manufacturer   | Type          | Circuit Breaker Lockout (Standard/ TAGLOCK™) |                             |                             |                   |                                | EZ Panel Loc™ (Standard/ TAGLOCK™) |                      | Mini Circuit Breaker Lockouts |                 |              |                     |                      |                                |
|----------------|---------------|--|-----------------------------|-----------------------------|-------------------|--------------------------------|------------------------------------|----------------------|-------------------------------|-----------------|--------------|---------------------|----------------------|--------------------------------|
|                |               | 120V Snap On (w/ hole)                       | 120/277V Clamp On (no hole) | 480/600V Clamp On (no hole) | Oversize 480/600V | Universal Multi-pole (tie bar) | Snap On (SQD QO)                   | Clamp On (Universal) | Pin Out Standard              | Pin In Standard | Pin Out Wide | Pin Out Wide Rotary | Multi-pole w/ TieBar | Universal Mini Breaker Lockout |
|                |               | 065387                                       | 065396                      | 065397                      | 065329            | 066321                         | 051252                             | 051254               | 090844                        | 090847          | 090850       | 149433              | 090853               | 149514                         |
|                |               | 148689                                       | 148690                      | 148701                      | 148692            | 148702                         | 148696                             |                      |                               |                 |              |                     |                      |                                |
|                |               | 148693                                       | 148698                      | 148687                      | 148691            | 148697                         | 148688                             |                      |                               |                 |              |                     |                      |                                |
|                |               | 148694                                       | 148699                      | 148686                      | 148685            | 148695                         | 148700                             |                      |                               |                 |              |                     |                      |                                |
| Square D       | FC            |  | •*                          |                             |                   |                                |                                    |                      |                               |                 |              |                     |                      |                                |
| Square D       | FCL           |  | •*                          |                             |                   |                                |                                    |                      |                               |                 |              |                     |                      |                                |
| Square D       | FDA           |  | •                           |                             |                   |                                |                                    | •                    |                               |                 |              |                     |                      |                                |
| Square D       | FGA           |  |                             |                             |                   |                                |                                    | •                    |                               |                 |              |                     |                      |                                |
| Square D       | FH            |  | •*                          |                             |                   |                                |                                    |                      |                               |                 |              |                     |                      |                                |
| Square D       | FHL           |  | •*                          |                             |                   |                                |                                    |                      |                               |                 |              |                     |                      |                                |
| Square D       | FHL-DC        |  | •*                          |                             |                   |                                |                                    |                      |                               |                 |              |                     |                      |                                |
| Square D       | FHP           |  | •*                          |                             |                   |                                |                                    |                      |                               |                 |              |                     |                      |                                |
| Square D       | FI            |  | •*                          |                             |                   |                                |                                    |                      |                               |                 |              |                     |                      |                                |
| Square D       | FIL           |  | •*                          |                             |                   |                                |                                    |                      |                               |                 |              |                     |                      |                                |
| Square D       | FY            |  | •*                          |                             |                   |                                |                                    |                      |                               |                 |              |                     |                      |                                |
| Square D       | GJL           |  | •*                          |                             |                   |                                |                                    |                      |                               |                 |              |                     |                      |                                |
| Square D       | KA            |  | •*                          |                             |                   |                                |                                    |                      |                               |                 |              |                     |                      |                                |
| Square D       | KAL           |  | •*                          |                             |                   |                                |                                    |                      |                               |                 |              |                     |                      |                                |
| Square D       | KAP           |  |                             | •                           |                   |                                |                                    |                      |                               |                 |              |                     |                      |                                |
| Square D       | KC            |  | •*                          |                             |                   |                                |                                    |                      |                               |                 |              |                     |                      |                                |
| Square D       | KCL           |  | •*                          |                             |                   |                                |                                    |                      |                               |                 |              |                     |                      |                                |
| Square D       | KH            |  | •*                          |                             |                   |                                |                                    |                      |                               |                 |              |                     |                      |                                |
| Square D       | KHL           |  | •*                          |                             |                   |                                |                                    |                      |                               |                 |              |                     |                      |                                |
| Square D       | KI            |  | •*                          |                             |                   |                                |                                    |                      |                               |                 |              |                     |                      |                                |
| Square D       | KIL           |  | •*                          |                             |                   |                                |                                    |                      |                               |                 |              |                     |                      |                                |
| Square D       | LA            |  |                             | •**                         |                   |                                |                                    |                      |                               |                 |              |                     |                      |                                |
| Square D       | LAL           |  |                             | •**                         | •                 |                                |                                    |                      |                               |                 |              |                     |                      |                                |
| Square D       | LAP           |  |                             | •**                         | •                 |                                |                                    |                      |                               |                 |              |                     |                      |                                |
| Square D       | LC            |  |                             |                             | •                 |                                |                                    |                      |                               |                 |              |                     |                      |                                |
| Square D       | LCP           |  |                             |                             | •                 |                                |                                    |                      |                               |                 |              |                     |                      |                                |
| Square D       | LH            |  |                             | •**                         |                   |                                |                                    |                      |                               |                 |              |                     |                      |                                |
| Square D       | LHL           |  |                             | •**                         | •                 |                                |                                    |                      |                               |                 |              |                     |                      |                                |
| Square D       | LHP           |  |                             | •**                         | •                 |                                |                                    |                      |                               |                 |              |                     |                      |                                |
| Square D       | L2            |  |                             |                             | •                 |                                |                                    |                      |                               |                 |              |                     |                      |                                |
| Square D       | LXL           |  |                             |                             | •                 |                                |                                    |                      |                               |                 |              |                     |                      |                                |
| Square D       | MA            |  |                             | •**                         |                   |                                |                                    |                      |                               |                 |              |                     |                      |                                |
| Square D       | MA            |  |                             |                             | •                 |                                |                                    |                      |                               |                 |              |                     |                      |                                |
| Square D       | MAL           |  |                             |                             | •                 |                                |                                    |                      |                               |                 |              |                     |                      |                                |
| Square D       | MH            |  |                             |                             | •                 |                                |                                    |                      |                               |                 |              |                     |                      |                                |
| Square D       | MH            |  |                             | •**                         |                   |                                |                                    |                      |                               |                 |              |                     |                      |                                |
| Square D       | MHL           |  |                             |                             | •                 |                                |                                    |                      |                               |                 |              |                     |                      |                                |
| Square D       | ML-1          |  |                             | •**                         |                   |                                |                                    |                      |                               |                 |              |                     |                      |                                |
| Square D       | ML-3          |  |                             |                             | •                 |                                |                                    |                      |                               |                 |              |                     |                      |                                |
| Square D       | MXL           |  |                             |                             | •                 |                                |                                    |                      |                               |                 |              |                     |                      |                                |
| Square D       | Q1B           |  | •                           |                             |                   |                                |                                    | •                    |                               |                 |              |                     |                      |                                |
| Square D       | Q1L           |  | •                           |                             |                   |                                |                                    | •                    |                               |                 |              |                     |                      |                                |
| Square D       | Q2            |  | •*                          |                             |                   |                                |                                    |                      |                               |                 |              |                     |                      |                                |
| Square D       | Q2H           |  | •*                          |                             |                   |                                |                                    |                      |                               |                 |              |                     |                      |                                |
| Square D       | Q2L           |  | •*                          |                             |                   |                                |                                    |                      |                               |                 |              |                     |                      |                                |
| Square D       | Q2MT          |  | •*                          |                             |                   |                                |                                    |                      |                               |                 |              |                     |                      |                                |
| Square D       | Q4            |  |                             | •**                         |                   |                                |                                    |                      |                               |                 |              |                     |                      |                                |
| Square D       | Q4L           |  |                             | •**                         |                   |                                |                                    |                      |                               |                 |              |                     |                      |                                |
| Square D       | QO            | •  | •                           |                             |                   |                                | •                                  | •                    |                               |                 |              |                     |                      |                                |
| Square D       | QOB           |  |                             |                             |                   |                                | •                                  |                      |                               |                 |              |                     |                      |                                |
| Square D       | QOB           | •  | •                           |                             |                   |                                | •                                  | •                    |                               |                 |              |                     |                      |                                |
| Square D       | QOB-H         |  |                             |                             |                   |                                | •                                  |                      |                               |                 |              |                     |                      |                                |
| Square D       | QOB-VH        | •  | •                           |                             |                   |                                | •                                  |                      |                               |                 |              |                     |                      |                                |
| Square D       | QOB-VH        |  |                             |                             |                   | •                              |                                    |                      |                               |                 |              |                     |                      |                                |
| Square D       | QO-H          |  |                             |                             |                   |                                | •                                  |                      |                               |                 |              |                     |                      |                                |
| Square D       | QOM1-VH       |  | •                           |                             |                   |                                |                                    | •                    |                               |                 |              |                     |                      |                                |
| Square D       | QOM2-VH       |  | •                           |                             |                   |                                |                                    | •                    |                               |                 |              |                     |                      |                                |
| Square D       | QO-SWN        | •  | •                           |                             |                   |                                | •                                  | •                    |                               |                 |              |                     |                      |                                |
| Square D       | QOU           |  |                             |                             |                   |                                | •                                  |                      |                               |                 |              |                     |                      |                                |
| Square D       | QOU           |  | •                           |                             |                   |                                | •                                  | •                    |                               |                 |              |                     |                      |                                |
| Square D       | QOU w/tie bar |  |                             |                             |                   | •                              |                                    | •                    |                               |                 |              |                     |                      |                                |
| Square D       | QO-VH         |  |                             |                             |                   |                                | •                                  |                      |                               |                 |              |                     |                      |                                |
| Square D       | QO-VH         | •  | •                           |                             |                   |                                | •                                  | •                    |                               |                 |              |                     |                      |                                |
| Square D       | QYU           |  |                             |                             |                   |                                | •                                  |                      |                               |                 |              |                     |                      |                                |
| Square D       | Y1            |  |                             | •                           |                   |                                |                                    |                      |                               |                 |              |                     |                      |                                |
| Sursum         | EA53          |  |                             |                             |                   |                                |                                    |                      |                               |                 |              |                     |                      |                                |
| Sylvania GTE   | QC            |  |                             |                             |                   | •                              |                                    | •                    |                               |                 |              | •                   |                      |                                |
| Sylvania GTE   | Type C        |  |                             |                             |                   | •                              |                                    | •                    |                               |                 |              |                     |                      |                                |
| Thomas & Betts | F Frame       |  |                             |                             |                   |                                |                                    | •                    |                               |                 |              |                     |                      |                                |
| Toshiba        | E225B         |  | •*                          |                             |                   |                                |                                    |                      |                               |                 |              |                     |                      |                                |
| Westinghouse   | BA w/tie bar  |  |                             |                             |                   | •                              |                                    |                      |                               |                 |              |                     |                      |                                |
| Westinghouse   | BA            | •  | •                           |                             |                   |                                |                                    | •                    |                               |                 |              |                     |                      |                                |
| Westinghouse   | BAB           | •  | •                           |                             |                   |                                |                                    | •                    |                               |                 |              |                     |                      |                                |
| Westinghouse   | BR            | •  | •                           |                             |                   |                                |                                    | •                    |                               |                 |              |                     |                      |                                |
| Westinghouse   | BR w/tie bar  |  |                             |                             |                   | •                              |                                    | •                    |                               |                 |              |                     |                      |                                |
| Westinghouse   | BRH w/tie bar |  |                             |                             |                   | •                              |                                    | •                    |                               |                 |              |                     |                      |                                |
| Westinghouse   | CA            |  | •*                          |                             |                   |                                |                                    |                      |                               |                 |              |                     |                      |                                |
| Westinghouse   | DA            |  |                             | •                           |                   |                                |                                    |                      |                               |                 |              |                     |                      |                                |
| Westinghouse   | DK            |  |                             | •                           |                   |                                |                                    |                      |                               |                 |              |                     |                      |                                |
| Westinghouse   | EB            |  | •*                          |                             |                   |                                |                                    | •                    |                               |                 |              |                     |                      |                                |

\* - Cleat (065404) accessory required    \*\* - Cleat (065406) accessory required

# Breaker compatibility overview

**i See page...**

- Standard Circuit Breaker: 56-57
- EZ Panel Loc™: 54
- Mini Circuit Breaker Lockouts: 54

|              |            | Circuit Breaker Lockout (Standard/ TAGLOCK™)              |   |   |   |   | EZ Panel Loc™ (Standard/ TAGLOCK™)                        |                      | Mini Circuit Breaker Lockouts |                 |              |                     |                      |                                |
|--------------|------------|---|---|---|---|---|---|----------------------|-------------------------------|-----------------|--------------|---------------------|----------------------|--------------------------------|
| Manufacturer | Type       | 120V Snap On (w/ hole)                                    | 120/277V Clamp On (no hole)                               | 480/600V Clamp On (no hole)                               | Oversize 480/600V   | Universal Multi-pole (tie bar)                            | Snap On (SQD QO)  | Clamp On (Universal) | Pin Out Standard              | Pin In Standard | Pin Out Wide | Pin Out Wide Rotary | Multi-pole w/ TieBar | Universal Mini Breaker Lockout |
|              |            | 065387<br><i>148689</i><br><i>148693</i><br><i>148694</i> | 065396<br><i>148690</i><br><i>148698</i><br><i>148699</i> | 065397<br><i>148701</i><br><i>148687</i><br><i>148686</i> | 065329<br><i>148692</i><br><i>148691</i><br><i>148685</i> | 066321<br><i>148702</i><br><i>148697</i><br><i>148695</i> | 051252<br><i>148696</i><br><i>148688</i><br><i>148700</i> | 051254               | 090844                        | 090847          | 090850       | 149433              | 090853               | 149514                         |
| Westinghouse | ED         |   | •   |   |   |   |   |                      |                               |                 |              |                     |                      |                                |
| Westinghouse | EH         |   | •   |   |   |   |   |                      |                               |                 |              |                     |                      |                                |
| Westinghouse | EHB        |   | •*  |   |   |   |   |                      |                               |                 |              |                     |                      |                                |
| Westinghouse | EHD        |   | •   |   |   |   |   |                      |                               |                 |              |                     |                      |                                |
| Westinghouse | FA         |   | •*  |   |   |   |   |                      |                               |                 |              |                     |                      |                                |
| Westinghouse | FB         |   | •*  |   |   |   |   |                      |                               |                 |              |                     |                      |                                |
| Westinghouse | FD         |   | •   |   |   |   |   |                      |                               |                 |              |                     |                      |                                |
| Westinghouse | FDB        |   | •   |   |   |   |   |                      |                               |                 |              |                     |                      |                                |
| Westinghouse | FDC        |   | •   |   |   |   |   |                      |                               |                 |              |                     |                      |                                |
| Westinghouse | FP         |   |   | •**   |   |   |   |                      |                               |                 |              |                     |                      |                                |
| Westinghouse | GB         |   | •   |   |   |   |   |                      |                               |                 |              |                     |                      |                                |
| Westinghouse | GBH        |   | •   |   |   |   |   |                      |                               |                 |              |                     |                      |                                |
| Westinghouse | GHB        |   | •   |   |   |   |   |                      |                               |                 |              |                     |                      |                                |
| Westinghouse | GR         |   |   | •   |   |   |   |                      |                               |                 |              |                     |                      |                                |
| Westinghouse | HBAW       | •   | •   |   |   |   |   |                      |                               |                 |              |                     |                      |                                |
| Westinghouse | HBAX       | •   | •   |   |   |   |   |                      |                               |                 |              |                     |                      |                                |
| Westinghouse | HCA        |   | •*  |   |   |   |   |                      |                               |                 |              |                     |                      |                                |
| Westinghouse | HFB        |   | •*  |   |   |   |   |                      |                               |                 |              |                     |                      |                                |
| Westinghouse | HFD        |   | •   |   |   |   |   |                      |                               |                 |              |                     |                      |                                |
| Westinghouse | HKD        |   |   | •   |   |   |   |                      |                               |                 |              |                     |                      |                                |
| Westinghouse | HLA        |   |   | •   |   |   |   |                      |                               |                 |              |                     |                      |                                |
| Westinghouse | HLB        |   |   | •   |   |   |   |                      |                               |                 |              |                     |                      |                                |
| Westinghouse | HMC        |   |   | •   |   |   |   |                      |                               |                 |              |                     |                      |                                |
| Westinghouse | HMCP       |   | •*  |   |   |   |   |                      |                               |                 |              |                     |                      |                                |
| Westinghouse | HNC        |   |   |   | •   |   |   |                      |                               |                 |              |                     |                      |                                |
| Westinghouse | HQNP       |   | •   |   |   |   |   |                      |                               |                 |              |                     |                      |                                |
| Westinghouse | HQP        | •   | •   |   |   |   |   |                      |                               |                 |              |                     |                      |                                |
| Westinghouse | JA         |   |   | •   |   |   |   |                      |                               |                 |              |                     |                      |                                |
| Westinghouse | JB         |   |   | •   |   |   |   |                      |                               |                 |              |                     |                      |                                |
| Westinghouse | JD         |   |   | •   |   |   |   |                      |                               |                 |              |                     |                      |                                |
| Westinghouse | JDB        |   |   | •   |   |   |   |                      |                               |                 |              |                     |                      |                                |
| Westinghouse | KA         |   |   | •**   |   |   |   |                      |                               |                 |              |                     |                      |                                |
| Westinghouse | KB         |   |   | •   |   |   |   |                      |                               |                 |              |                     |                      |                                |
| Westinghouse | LA         |   |   | •**   |   |   |   |                      |                               |                 |              |                     |                      |                                |
| Westinghouse | LB         |   |   | •   |   |   |   |                      |                               |                 |              |                     |                      |                                |
| Westinghouse | LBB        |   |   | •   |   |   |   |                      |                               |                 |              |                     |                      |                                |
| Westinghouse | LH         |   |   | •   |   |   |   |                      |                               |                 |              |                     |                      |                                |
| Westinghouse | MA         |   |   | •**   |   |   |   |                      |                               |                 |              |                     |                      |                                |
| Westinghouse | MC         |   |   | •**   |   |   |   |                      |                               |                 |              |                     |                      |                                |
| Westinghouse | MCC        |   |   | •**   |   |   |   |                      |                               |                 |              |                     |                      |                                |
| Westinghouse | MCPO       |   | •*  |   |   |   |   |                      |                               |                 |              |                     |                      |                                |
| Westinghouse | NB         |   |   |   | •   |   |   |                      |                               |                 |              |                     |                      |                                |
| Westinghouse | P          |   | •   |   |   |   |   |                      |                               |                 |              |                     |                      |                                |
| Westinghouse | PA         |   |   |   |   |   |   |                      |                               |                 |              |                     |                      |                                |
| Westinghouse | QBHW       | •   | •   |   |   |   |   |                      |                               |                 |              |                     |                      |                                |
| Westinghouse | QC         | •   | •   |   |   |   |   |                      |                               |                 |              |                     |                      |                                |
| Westinghouse | QC         |   |   |   |   | •   |   |                      |                               |                 |              |                     |                      |                                |
| Westinghouse | QCHQ       | •   | •   |   |   |   |   |                      |                               |                 |              |                     |                      |                                |
| Westinghouse | QHCW       | •   | •   |   |   |   |   |                      |                               |                 |              |                     |                      |                                |
| Westinghouse | QHCX       | •   | •   |   |   |   |   |                      |                               |                 |              |                     |                      |                                |
| Westinghouse | QHPW       | •   | •   |   |   |   |   |                      |                               |                 |              |                     |                      |                                |
| Westinghouse | QPHW       | •   | •   |   |   |   |   |                      |                               |                 |              |                     |                      |                                |
| Westinghouse | Quicklag P |   | •   |   |   |   |   |                      |                               |                 |              |                     |                      |                                |
| Westinghouse | RE         |   | •   |   |   |   |   |                      |                               |                 |              |                     |                      |                                |
| Westinghouse | RH         |   |   | •   |   |   |   |                      |                               |                 |              |                     |                      |                                |
| Westinghouse | WPHX       | •   | •   |   |   |   |   |                      |                               |                 |              |                     |                      |                                |
| Wylex        | WRS40/2    |   |   |   |   |   |   |                      |                               |                 | •            |                     |                      |                                |
| Zinsco       | HQB        |   | •   |   |   |   |   |                      |                               |                 |              |                     |                      |                                |
| Zinsco       | QB         |   | •   |   |   |   |   |                      |                               |                 |              |                     |                      |                                |

\* - Cleat (065404) accessory required    \*\* - Cleat (065406) accessory required



**Africa**

Randburg, South Africa  
 Tel.: +27 11 704 3295  
 Email: africa@bradycorp.com

**Benelux**

Zelev, Belgium  
 Tel.: +32 (0) 52 45 78 11  
 Email: benelux@bradycorp.com

**Central & Eastern Europe**

Bratislava, Slovakia  
 Tel.: +421 2 3300 4800  
 Email: central\_europe@bradycorp.com

**Denmark**

Odense  
 Tel.: +45 66 14 44 00  
 Email: denmark@bradycorp.com

**France**

Roncq  
 Tel.: +33 (0) 3 20 76 94 48  
 Email: france@bradycorp.com

**Germany, Austria & Switzerland**

Egelsbach, Germany  
 Tel.: +49 (0) 6103 7598 660  
 Email: germany@bradycorp.com

**Hungary**

Budaörs  
 Tel.: +36 23 500 275  
 Email: central\_europe@bradycorp.com

**Italy**

Gorgonzola  
 Tel.: +39 02 26 00 00 22  
 Email: italy@bradycorp.com

**Middle East FZE**

Dubai, UAE  
 Tel.: +971 4881 2524  
 Email: me@bradycorp.com

**Norway**

Kjeller  
 Tel.: +47 70 13 40 00  
 Email: norway@bradycorp.com

**Russia**

Moscow  
 Tel.: +7 495 269 47 87  
 Email: central\_europe@bradycorp.com

**Spain & Portugal**

Madrid, Spain  
 Tel.: +34 900 902 993  
 Email: spain@bradycorp.com,  
 portugal@bradycorp.com

**Sweden, Finland, Baltic states**

Kista, Sweden  
 Tel.: +46 (0) 8 590 057 30  
 Email: sweden@bradyeurope.com

**Turkey**

Istanbul  
 Tel.: +90 212 264 02 20 / 264 02 21  
 Email: turkey@bradycorp.com

**UK & Ireland**

Banbury, UK  
 Tel.: +44 (0) 1295 228 288  
 Email: uk@bradycorp.com

# Our mission is to identify and protect people, products and premises



To help minimise our impact on the environment, Brady limits its number of reprints.

Updated versions are always available for download on [www.bradyeurope.com](http://www.bradyeurope.com).

 Search for: EUR-M-415-EN



Y2370188

Your distributor

26/08/2020