

SPO5L2S

Family	Professional ovens
Subfamily	Combi 5 GN1/1 or 4EN trays 600x400 mm
Oven type	Galileo Professional combisteamer oven
Power supply	400 V 3N~ / 17 A / 8 kW / 50-60 Hz
Width	790 mm
Depth	833 mm
Height	645 mm
Maximum depth with open door	1581 mm
Adjustable feet	Yes
Net weight	90.000 kg



Target

Solutions	Hotels; Restaurants/Pubs; Bakery/Pastry making; Frozen bakery industry; Food retail; Health and care; Catering and Institutions
------------------	---

Aesthetics

Colour	Stainless steel/Black	Digit display color	Multicolor
Door with stainless steel stripes	Yes	Front panel	Glass/Stainless steel
Display type	TFT digital, 7 inches touch	Logo	Smeg sticker

Controls

Storable programs number	512 max.	Hold function	Adjustable
Preset recipes	>100	Forced cooling	Yes
Timer setting range	from 1 minute to 23h:59 minutes per step	Chimney regulation	Automatic
Cooking steps	8	Wash programs	Short/medium/long/grill/rinse
Delayed start	Yes; No	HACCP data	Yes
Pre-heating	Yes	Self diagnostic	Yes

Programme / Functions

Backing functions



Convection



Direct steam



Open boiler steam



Core probe + Δ t



Combined cooking



Vacuum low temperature



Grill



Proving

Adjustable fan speed



Adjustable fan speed from 50 to

100%

Wash system:



Automatic washing

Options

Combinable hood K4610X (with connection kit KITPO45)

Accessories Included

Probe 4 points external core probe

Electrical Connection

Plug Not present

Construction

Oven materials	Stainless steel / glass / plastics	Exhaust position	Back
Cavity dimensions (wxdxh)	670x560x420 mm	Components cooling system	Yes
Cavity material	Stainless steel	Timer type	Electrical
Shelves number	5 GN1/1 or 4 EN 600x400	Temperature range	30-270°C
Tray frame support	Stainless steel AISI 304	End cooking signal	Yes
Adapter kit for trays 600x400 mm	Yes	Safety switch with open door	Yes
Shelves distance	70 mm GN1/1 - 90 mm EN 600x400	Manual reset safety thermostat	Yes
Door construction	Triple glass	Removable deflector	Yes
Door opening	Lateral - left hinge	Detergent type	Liquid
		Detergent tank	Vanishing 3l

Handle type	Rotating	Light switch with open door	Yes
Glass	Openable with hinge	Lighting	1 LED lamp
Fan motor power	200W	Light power	3.6 W
Engine rpm	Progressive %	USB port	Yes
Motor rpm in standard speed	2850 rpm	Water load pipe	Yes
Motor rpm in low speed	1425 rpm	Water entries number	1
Water injection on each fan	Yes	Power cable length	170 cm
Humidification levels	Automatic / Percentage progressive	Back panel	Galvanized
Open boiler	Yes	IPX protection	IPX4
Drain diameter	1" 1/2 - DN 40 mm		

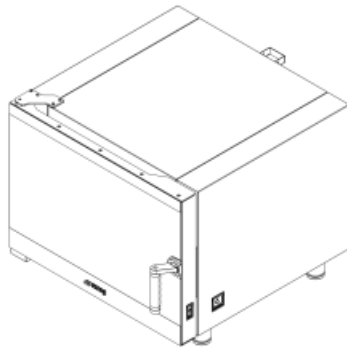
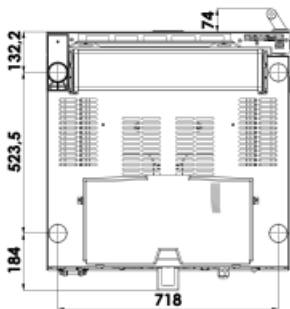
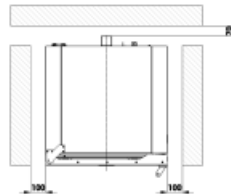
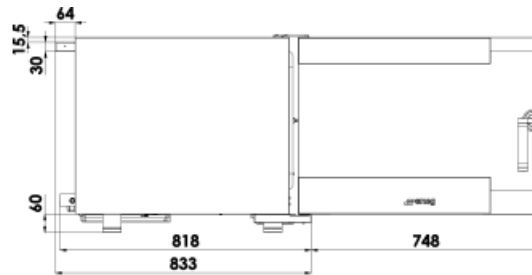
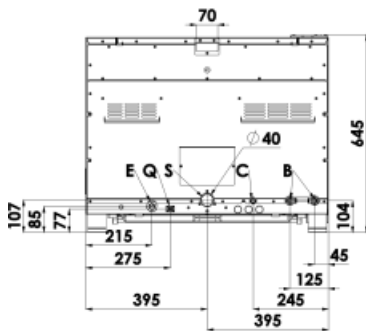

Q	MORSETTO EQUIPOTENZIALE EARTH TERMINAL
E	CAVO ALIMENTAZIONE ELETTRICA ELECTRICITY SUPPLY CABLE
C	TUBO DI CARICO FILLER HOSE
S	TUBO DI SCARICO DRAIN HOSE
B	BYPASS DECALCIFICATORE BYPASS DESCALER

Not included accessories



3805
Flat chrome-plated wire grid (4pcs)



3743
Flat aluminium tray (4pcs)

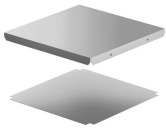

SLFT
Galileo table shelf kit



KITPO45
Connection kit for Galileo professional oven and K4610X hood

CLB45LSE
Flow meter for filter FB45LSE1100

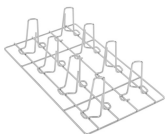

G11X8P
8 vertical GN1/1 chicken grid for Galileo professional



KITSTCK55
Conjunction kit between 2 combined 4 and 5 trays ovens



3751
Flat perforated aluminium tray (4pcs)



STDH
Galileo oven support frame - 8 trays

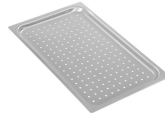

TF11XH2
Perforated aluminium GN1/1 tray for Galileo professional



TB45LSE
Water treatment filter head connection kit

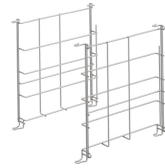

R4EN6040
Support kit for EN 600x400 trays



STDM
Galileo oven support frame - 4 trays



T11TH20
2cm height GN1/1 non-stick tray for Galileo professional

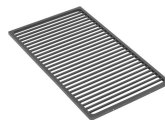

G11T
Non-stick GN1/1 tray for Galileo professional





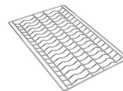







FB45LSE1100
Water treatment filter for Galileo professional oven; 7.900 litres capacity with 10 Kh hardness and bypass set 1



3810
Waved grid for baguettes (4pcs)

Symbols glossary (TT)

	Fan speed adjustable between 50 and 100% of the speed		Automatic washing
	Fan forced heating		Core probe baking by temperature difference (Δt)
	Dry heat for a perfect grill		Steam generated by injecting water into the fan and evaporation on the heating element
	Saturated steam created by boiling in the cavity		Steam and hot air combined cooking
	Low cooking sous-vide		Humidity and heat controlled proving