

K4610X

Product family	Professional hood
Subfamily	Extraction
Hood Type	Mounted on oven
Design	Angled
Tecnology	Suction and filtering hood
Extraction	Recirculation
Electronic control	Yes
Suitable for	Combined oven 5 GN1/1 ; Convection ovens 600x400 mm - GN1/1
Material	Stainless steel
Type of steel	Polished
Hood width	80 cm





Aesthetics

Colour	Stainless steel	Logo	Embossed
Components finishing	Stainless steel		

Controls

Control setting	Touch control back-lighted White	Led color	White
-----------------	-------------------------------------	-----------	-------

Programme / Functions

No. of speeds	3
Intensive speed	
24h air filter function	
Time-setting options	

Technical Features

						
No. of lights	1	No. of filters	2			
Light type	LED	Anti-grease filters	Buffle			
Light Power	1,1 W	Charcoal filters included	Yes			
Dimmer mode	Yes	Filter replacement indicator	Yes			

Light color temperature scale (°K) 4000 °K
 Free outlet maximum capacity 900 m³/h
 Motor power 330 W

Vent outlet 150 mm
 Non return valve Yes

Electrical Connection

Voltage 220-240 V
 Frequency (Hz) 50-60 Hz

Power supply cable length 1500 mm

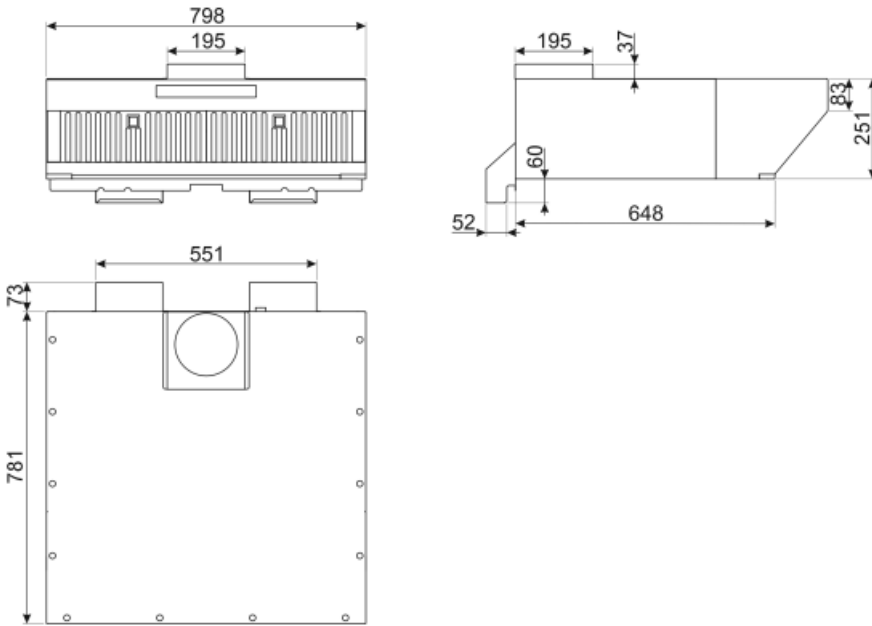

Not included accessories



FLT6

Round Charcoal filters (kit 2 pieces)



KITALLFC









Universal Charcoal filter Stainless Steel AISI 304 The filter can be washed in dishwasher 50 °C (water and suitable detergent) and to dry it put in the oven 180°C 25 minutes



KITCMNKVX

Chimney Extension in Stainless Steel for hood KV*series 300 mm*200 mm + 500/850 mm

Symbols glossary (TT)

- | | | | |
|--|---|---|---|
|  | 24h: When selected this function refreshes the air for c. 10 minutes every hour over a 24 hour period, at minimum speed and an imperceptible noise level. |  | Filters: Model has filters to help remove grease from the steam emanating from the pans during cooking. |
|  | Switch off automatically: A special setting, to run after the end of cooking for a pre-set time and then switch off automatically. |  | Charcoal filters: Extracting through charcoal filters or directly to the exterior lessens strong cooking odours considerably. |
|  | Warning light(s): to advise when filters need changing. |  | Lights: All cooker hoods feature lights to illuminate the cooking area or add to the ambience of the kitchen. |
|  | Intensive/turbo setting: when extra fast extraction is required. |  | Dimmering Lights |