

# How to Grow Medical Marijuana



Treated for cancer nine times before he was ten, Todd McCormick learned early on the healing power of one of humanity's oldest medicinal herbs. Now he shares with his fellow medical patients what he knows about cultivating this therapeutic plant.

## Todd McCormick

with an Introduction by Peter McWilliams

# Woody Harrelson and Todd McCormick on *Politically Incorrect*

*Todd:* The government has been trying to put me in jail for ten-years-to-life because I grew my own medicine.

*Woody:*  
And he's never hurt anybody

## **Todd McCormick may spend the rest of his life in prison for researching this book**

On July 29, 1997, Todd McCormick was arrested by the DEA for growing (“manufacturing”) medical marijuana in his own home, in California, after the passage of Proposition 215 that specifically permitted medical marijuana “cultivation.”

McCormick faces a ten-year mandatory minimum sentence (possibly life) and a \$4,000,000 fine.

*All you need to know  
are a few basics.*

*First, there are  
male and female plants.  
The substance that gives  
marijuana its famous  
psychoactive kick  
is concentrated in the  
flowers or buds of the females.  
So when they're old enough  
to tell them apart,  
kill the males.*

*Two, give your plants  
plenty of light  
and not too much water.*

**P**ETER JENNINGS  
*ABCs News Special  
"Pot of Gold"  
1997, rebroadcast 1998*

(The last time we checked, Peter Jennings had not been arrested by the DEA for his research.)

*The greatest service  
which can be rendered  
any country  
is to add  
a useful plant  
to its culture.*

**T**HOMAS **J**EFFERSON

# How to Grow Medical Marijuana

by Todd McCormick

Design, editing, and Introduction by Peter McWilliams

© 1998 by Medical Marijuana Press  
8159 Santa Monica Boulevard  
Los Angeles, California 90046

*Make the most of the hempseed,  
sow it everywhere.*

GEORGE WASHINGTON

*This book is dedicated to:*

*The Sun and Mother Nature for conspiracy to cultivate  
medical marijuana.*

*All the world's innocent criminals .*

*Those being sought after and prosecuted while utiliz-  
ing and cultivating this planet's most valuable natural  
resource.*

*Someday understanding will come about, laws will  
change and Mother Nature's most precious gift and its  
users will be released from tyranny.*

*To forbid  
or even seriously restrict  
the use of so holy  
and gracious a herb  
would cause widespread  
suffering and annoyance,  
and to large bands of  
worshipped ascetics,  
deep-seated anger.*

*It would rob the people  
of a solace in discomfort,  
of a cure in sickness,  
of a guardian whose  
precious protection  
saves them from the attacks  
of evil influences...*

*Like his Hindu brother,  
the Musalman fakir  
reveres Bhang  
as the lengthener of life,  
the freer from the bonds of self.*

*Bhang brings union  
with the Divine Spirit.*

*“We drank Bhang and  
the mystery I am  
grew plain.  
So grand a result,  
so tiny a sin.”*

**J.M. CAMPBELL**

*Note on the Religion of Hemp  
British Indian Hemp Drugs  
Commission Report  
1839-1894*

# Contents

*Who Is Todd McCormick? ..... 19*

*Transcript of  
Politically Incorrect ..... 45*

## CHAPTER ONE

*Medical Marijuana:  
A Brief History..... 89*

## CHAPTER TWO

*The Sea of Green ..... 105*  
*Where to start? ..... 111*

## CHAPTER THREE

*Planting and The Plant..... 115*  
*The Family Tree  
of Medical Marijuana ..... 117*  
*Hempseed and Health ..... 119*  
*Where To Get Medical Marijuana Seeds 125*  
*Germination ..... 133*  
*Planting ..... 135*

CHAPTER FOUR

<b><i>The Grow Rooms</i></b> .....	<b>139</b>
<i>Supplies and Equipment</i> .....	145
<i>Incandescent</i> .....	147
<i>Fluorescent</i> .....	147
<i>High-Intensity Discharge (HID)</i> .....	149
<i>Metal Halides (or MH lamps)</i> .....	151
<i>High Pressure Sodium (or HPS lamps)</i>	151
<i>Supply List</i> .....	157
<i>The Three Rooms</i> .....	159
<i>Clone Room</i> .....	159
<i>Mother Room</i> .....	161
<i>Flower Room</i> .....	161
<i>Ventilation</i> .....	161
<i>Fans</i> .....	163

CHAPTER FIVE

<b><i>The Vegetative Stage</i></b> .....	<b>165</b>
<i>Transplanting</i> .....	167
<i>The Health Of Your Seedlings</i> .....	169
<i>Fertilizing and Watering</i> .....	171
<i>Temperature And Humidity</i> .....	175

CHAPTER SIX

<b><i>Sexing and Cloning</i></b>	
<b><i>Your Plants</i></b> .....	<b>177</b>
<i>Sexing</i> .....	179
<i>Cloning</i> .....	181
<i>Back to Sex</i> .....	189
<i>The Mother Plant</i> .....	191
<i>The Flower Room</i> .....	193

CHAPTER SEVEN

<b><i>Flowering</i></b> .....	<b>195</b>
-------------------------------	------------

CHAPTER EIGHT

<b><i>Harvesting and Curing</i></b> .....	<b>201</b>
---	------------

CHAPTER NINE

<b><i>Cloning For a</i></b>	
<b><i>Continuous Harvest</i></b> .....	<b>207</b>

CHAPTER TEN

<b><i>Hydroponics</i></b> .....	<b>213</b>
---------------------------------	------------

CHAPTER ELEVEN

<b><i>Pruning</i></b> .....	<b>223</b>
-----------------------------	------------



CHAPTER TWELVE

*Security in the*

*(Not-so) Free World ..... 227*

CHAPTER THIRTEEN

*Consuming ..... 235*

*More Medical Marijuana*

*Information ..... 249*

*It is unnatural  
to make a plant illegal.*



## INTRODUCTION

### *Who Is Todd McCormick?*

“Todd McCormick had cancer nine times before he was ten.” That’s the journalistic shorthand for what happened to Todd McCormick.

The longhand truth is far worse.

Starting at the age of two, McCormick had a series of tumors known as Histiocytosis X. Now science knows this to be a benign tumor of childhood that usually goes away on its own. When Todd McCormick was two, unfortunately, medical science treated Histiocytosis X as a malignant cancer requiring aggressive treatment. This included chemotherapy, radiation, and surgery—all of which were inflicted on young Todd nine times between the ages of two and ten.

*Research on the therapeutic use of marijuana should be treated with the same high standards for scientific research required of any other drug with a high potential for abuse. The existing FDA-NIH-DEA process ensures that decisions regarding Investigational New Drug applications are based on their scientific merits. Any departure from this established process is a breach of the public trust that all Americans rely upon to safeguard the quality of our world class medical system.*

OFFICE OF NATIONAL  
DRUG CONTROL POLICY  
(McCaffrey's Lair.)  
*Statement on Marijuana  
for Medical Purposes,  
six days after Todd's arrest,  
August 4, 1997*

Thanks to improper medical treatment—not cancer—Todd has the top five vertebra of his spine surgically fused together and has one hip frozen by radiation the size of an eight-year-old boy. A specialist who had studied the adult Todd's X-rays but had never met Todd was shocked to find that Todd was not permanently confined to a wheelchair.

For over a decade the medical profession, through a mistake—an honest mistake, a government-approved mistake, but a mistake nonetheless—made Todd unnecessarily and permanently disabled. In addition, the treatment more than likely has shortened his life.

Now the government that sanctioned Todd's mutilation as "FDA-approved proper medical procedure" want to put him in jail for the rest of his life for attempting to treat his pain brought on by governmental incompetence. And, adding insult to injury, the government tells us it is doing this to "protect the children."

Where was the government when Todd was two and in need of some protection?

As you can see, the whole story is a little long for the lead in most newspapers, so it became shortened to, "Todd McCormick had cancer nine times before he was ten."

Todd and I met at the end of 1996 while I was researching a book on medical marijuana. AIDS and cancer in March 1996, and the nausea brought on by the treatment of same, convinced



Unusually in the plant kingdom, medical marijuana has both male (top) and female (bottom) plants.

me of marijuana's medicinal effectiveness. If I lived, I told myself, I would not rest until medical marijuana was available to every sick person in America who needed it. I lived, but I'm a long way from my goal. But back to late 1996.

What a treasure trove of information is Todd McCormick! Self-medicating with Todd is a university education in *Cannabis sativa*. Not only was he clearly an expert grower, he was also working on determining which strains of marijuana worked best for individual medical conditions.

Todd explained that medical marijuana is one of the most advanced and versatile plants in the entire Plant Kingdom. Marijuana has a male plant and a female plant—very rare in botany. Most plants have both sexes in the same plant.

Because there are two sexes, medical marijuana can be bred, the offspring taking on the characteristics of both mama and papa. In more than 5,000 years of human medical use, this breeding has led to an almost uncountable (more than 30,000, at least) variations in the medical marijuana plant.

Todd's goal was and is to identify which strains (variations) best treat which illnesses.

For example, some medical marijuana is known for deep bodily relaxation. These strains are good for people with muscle spasms, chronic bodily tension, and pain. Other medical marijuana, however, produces the purely mental responses of alertness, clarity, and creativity. These strains might be best for nausea, depression, and pain.

Yes, pain relief appears on both lists, as pain relief is one of the many medical benefits of marijuana that appear in just about every strain, except for certain hemp strains in which all medicinal value has been bred out.

Medical marijuana has the unique ability to filter out pain—either emotional or physical—but allow pleasure and the sense of touch to come through. This was scientifically confirmed in October 1997 by a report from the Society for Neuroscience.

(Please see the *Medical Marijuana Magazine Online*, [www.marijuanamagazine.com](http://www.marijuanamagazine.com) for more details on this report and other medical uses of marijuana.)

Todd had edited a magazine called *HempLife* in Holland. He had hoped to start a United States edition, but I persuaded him to write a book first.

I gave Todd an advance and he used it to rent the ugliest house in Bel Air, dubbed by the press Medical Marijuana Mansion, but known to Todd's friends as Liberty Castle. It was built to resemble a castle; a castle made of stucco. Nuveau mediaeval, I called it. It had as much charm as Janet Reno.

There, awash with Reno Rococo, Todd set up his research facility. He gathered dozens of strains of marijuana. The house became an ad hoc university of medical marijuana—cultivation being but one of many subjects discussed. Everyday all day there were new sick people or caregivers for sick people and Todd would enthusiastically

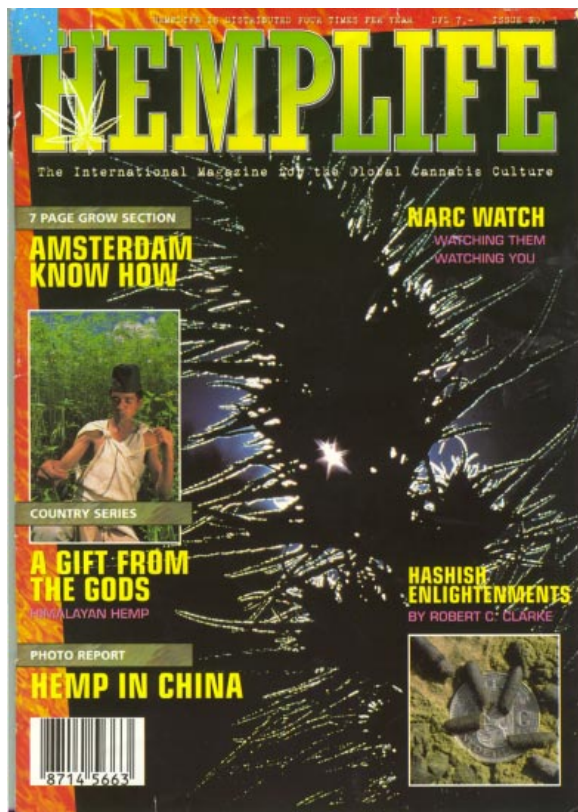

*This is the magazine Todd edited, and yet the federal government refuses to acknowledge him as a writer. The image on the cover is the shadow of a medical marijuana with a near-solar eclipse behind.*





*Todd in one of several completely unnecessary body casts he would wear throughout his childhood. Photographs by Ann McCormick.*

answer all questions. Todd credits marijuana with his life, so he is highly sympathetic to those in medical need.

Todd's mother started giving him medical marijuana for the nausea of chemotherapy and radiation when Todd was nine. Todd feels he never would have survived that bout with chemotherapy—his eighth—without medical marijuana. Kids on his ward were dying of malnutrition and dehydration brought on by nausea, yet Todd retained a healthy appetite and—as importantly, he thinks—a healthy attitude.

His mother couldn't tell the other mothers in the 'cancer ward—if word got out she was giving a nine-year-old marijuana they would have taken Todd from her, as well as her other two children, one of whom has Down's syndrome.

On July 29, 1997—after an exhaustive five-day investigation and using a California search warrant obtained by intentionally concealing from a judge that Todd was an outspoken medical marijuana patient and, therefore, legal under Proposition 215—the federal Drug Enforcement Administration (DEA) and the Los Angeles Sheriff's Narcotics Bureau raided Todd's home.

Fifty agents, armed and in flack jackets, stormed the house as though they were capturing San Juan Hill—or, more accurately, the compound in Waco, Texas.

They found no money, no evidence of drug sales, just Todd's research material—every plant carefully botanically labeled with white identifi-



*My style of gardening.*

cation tags the government claimed were used to indicate the intended buyer of the plant.

Completely ignoring Todd's plea to just seize the plants but not destroy them, DEA & company hacked to death genetic strains that may not exist anywhere else in the world. Todd had one plant that had been continuously alive since 1976.

Gone, all gone.

Todd was then charged with “manufacturing a controlled substance” and faces life in federal prison—mandatory-minimum ten-year sentence—and a \$4 million fine. “They want to put my son in jail for gardening!” Todd's mother said on hearing the news.

Bail was set at an outrageous \$500,000. (Murder suspects are released on \$50,000 bonds all the time). Todd's friend, Woody Harrelson, rode to the rescue just like a movie hero and put up the money to bail Todd out. Way to go, Woody.

A year later, Todd has not gone to trial. The government, it seems, is not happy with a simple “manufacturing” count. The Federal Grand Jury refused to indite Todd on “distribution” or even “possession with intent to distribute.” Rebuffed (something the government is not accustomed to before Federal Grand Juries, who have been referred to by many legal experts as “rubber stamps”), the government has spent the past year looking for a juicier “conspiracy” count.

If you and I are in a room alone and I say to you, “Let's grow medical marijuana and sell it,”



*On the way out, the DEA wished me a nice day. Hurricane Janet's wake, as reported by ABC News on John Stossel's Sex, Drugs & Consenting Adults. (Online at [www.marijuanamagazine.com](http://www.marijuanamagazine.com))*

and you say, "Sure," in that moment, without making a single move to do anything about our decision, both of us are guilty of conspiracy. "Conspiracy to manufacture a controlled substance," "conspiracy to possess a controlled substance," "conspiracy to distribute a controlled substance," and so on. Under current law, for our simple conversation, we could spend the rest of our lives in jail.

Because of my book advance, which Todd used to finance his project, the DEA and the IRS have been trying for more than a year to prove that I am the lead conspirator, a drug kingpin, the head of the Medical Marijuana Mafia, commander-in-chief of the Medical Marijuana Malitia, and mastermind behind the Medicin  Cartel. If found guilty of conspiracy, I'd be confined to a federal prison for life which, considering my AIDS and the medical treatment available in federal prison, would not be a long one.

On December 17, 1997, nine DEA/IRS agents came into my home, handcuffed me, and spent three hours going through every piece of paper in my house. They clearly weren't looking for drugs. They took away my computer containing two years worth of unpublished work, including several books on medical marijuana and a book critical of the DEA. (This has since turned into three books critical of the DEA.)

Meanwhile, in exchange for "information" and testimony, one of the largest marijuana growers in Southern California—who shall remain



## PROPOSITION 215 COMPASSIONATE USE ACT OF 1996

### **Section 1. Section 11362.5 is added to the Health and Safety Code, to read:**

*11362.5. (a) This section shall be known and may be cited as the Compassionate Use Act of 1996.*

*(b) (1) The people of the State of California hereby find and declare that the purposes of the Compassionate Use Act of 1996 are as follows:*

*(A) To ensure that seriously ill Californians have the right to obtain and use marijuana for medical purposes where that medical use is deemed appropriate and has been recommended by a physician who has determined that the person's health would benefit from the use of marijuana in the treatment of cancer, anorexia, AIDS, chronic pain, spasticity, glaucoma, arthritis, migraine, or any other illness for which marijuana provides relief.*

*(B) To ensure that patients and their primary caregivers who obtain and use marijuana for medical purposes upon the recommendation of a physician are not subject to criminal prosecution or sanction.*

*(C) To encourage the federal and state governments to implement a plan to provide for the safe and affordable distribution of marijuana to all patients in medical need of marijuana.*

*(2) Nothing in this act shall be construed to supersede legislation prohibiting persons from engaging in conduct that endangers others, nor to condone the diversion of marijuana for nonmedical purposes.*

*(c) Notwithstanding any other provision of law, no physician in this state shall be punished, or denied any right or privilege, for having recommended marijuana to a patient for medical purposes.*

*(d) Section 11357, relating to the possession of marijuana, and Section 11358, relating to the cultivation of marijuana, shall not apply to a patient, or to a patient's primary caregiver, who possesses or cultivates marijuana for the personal medical purposes of the patient upon the written or oral recommendation or approval of a physician.*

*(e) For the purposes of this section, "primary caregiver" means the individual designated by the person exempted under this act who has consistently assumed responsibility for the housing, health, or safety of that person.*

*Sec. 2. If any provision of this measure or the application thereof to any person or circumstance is held invalid, that invalidity shall not affect other provisions or applications of the measure which can be given effect without the invalid provision or application, and to this end the provisions of this measure are severable.*

nameless, for now—continues to operate with the full knowledge of both the federal government and the California Attorney General, Dan Lungren. (Lungren, who also appointed himself state Drug Czar, has not stopped going after medical marijuana growers and distributors considerably smaller than this informant's.)

People ask, looking back on the endless attacks on California medical marijuana patients that have occurred since Todd's arrest, "Why did any of you do what you did? Were you all crazy?"

The answer is, yes, we were (and continue to be) crazy but, no, we were not insane. There were several practical reasons in March 1997, when Todd set up his research facility, to think medical marijuana patients growing their own medicine in California was perfectly legal.

First, there was Proposition 215, now the California Compassionate Use Act of 1996, passed by an overwhelming majority in November 1996. More Californians voted for Proposition 215 than voted for Bill Clinton in the same election. The Proposition permitted medical marijuana patients and their caregivers to "cultivate" medical marijuana.

Second, it was the duty of California's Attorney General, Dan Lungren, to challenge Proposition 215 in court if he felt it legally improper. Lungren did not do this. Indeed, California's Attorney General said it was all right to break federal law and grow "1 to 2 plants". (You can grow one plant, you can grow two plants, but how on Earth

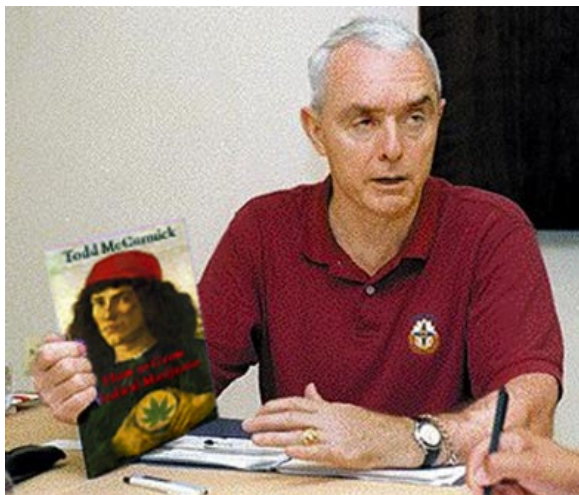

*“I don’t believe in banning books, except for books I don’t like, or books that make fun of me. I...uh...what was I talking about? I had...um...a little too much to drink last night. You know...uh...how it is. The...um...old ‘second bottle syndrome.’ What was I saying?”*

can you possibly grow “1 to 2 plants”?) Besides, even if AG Lungren didn’t like medical marijuana, the Constitution of California said “It shall be the duty of the Attorney General to see that the laws of the State are uniformly and adequately enforced.” That, and other admonitions of the California Constitution, we thought, would keep the AG in line. That is, we were foolish enough to believe Dan Lungren would follow the Constitution of the State of California.

Third, our national Drug Czar, General Barry McCaffrey, had pulled back from his initial assault on California’s medical marijuana users after a federal court in San Francisco told him in early 1997 to leave physicians alone. McCaffrey, having taken a beating in both the court and the press over medical marijuana, commissioned in February 1997 a \$1 million study from the National Academy of Sciences Institute of Medicine (NAS/IOM) and distanced himself completely from, as he called it, “the medical marijuana issue.” When asked a question about medical marijuana, he would turn it aside with, “It is in the hands of science, and scientists will decide.” (We’ll see what he has to say in December 1998 when the NAS/IOM report is published.)

Fourth, the press discussed the medical use, sale, and cultivation of marijuana as a commonplace event. *The New York Times Magazine* featured a cover story on how well law enforcement and medical marijuana suppliers were getting along—cooperating, even—to honor the will of



*Hemp harvest, from an old photograph.*



*Drug War harvest, from an old photograph.*

the people of California in getting medicine to the sick. The press portrayed an easy truce, growing into trust, between patients, caregivers, and law enforcement. Although arrests for marijuana continued unabated (one every 48 seconds in the United States), arrests for medical marijuana in California were, it seemed, a thing of the past.

Since Todd's July 1997 arrest, of course, New York *Times* headlines are more likely to read, *Four California Mayors Ask Clinton to Stop Marijuana Club Suit*, (March 22, 1998) about the civil—not criminal—lawsuits filed by the federal government against six California compassion clubs; or this headline from May 26, 1998, *Defiant Marijuana Club Closed in Sheriff's Raid*, about California Attorney General Lungren's Holy Crusade to personally destroying the San Francisco Buyer's Club. (He succeeded, over the strong objections of San Francisco's chief health officer, District Attorney, and Mayor.)

Finally, there had not been a single medical marijuana arrest in California—on the federal or state level—for eight months following the November 1996 passage of Proposition 215. Todd's arrest in July 1997 was the first federal medical marijuana arrest since 215.

I was emboldened to put in a garden myself. I felt like Florence Nightingale and George Washington Carver combined. I had 300 plants. As you shall learn in detail in this book, each plant produces 7 to 10 grams of medical marijuana, or three plants to the ounce. As I used medical marijuana



*This tray hold 98 “cuttings” or “clones.” Each of these 98 cuttings the DEA considers a fully grown marijuana plant—and so does federal law.*



*Here’s Todd, watering his plants. The visible portion of the top two rows in this picture contain almost 600 plants. Can you see why Todd having 4,000 plants is not as dramatic as the DEA likes to make it sound? (Both of these photographs will return later in the book with more grow-orientated captions.)*

at the rate of two ounces per week, the 100 ounces from my garden would last me a year.

It’s hard to imagine now, but for one brief shining moment, we were in Camelot.

It was brief, all right. The Liberty Castle lasted less than four months. It could have been a beacon of healing, comfort, and learning. Instead, a year later, it stands empty. The owner can neither sell it nor lease it. No one, it seems, has a use for the place but Todd.

Todd’s life is his work, his work being the education about and propagation of an herb he personally knows to ease suffering and save lives.

Todd is a good person on an important mission. Todd has a compassionate heart. He also has a body broken by government incompetence—the same government that wants to put him in prison for treating the pain that the government inflicted on him in the first place; the same government that has prevented him from using his medicine of choice for a year now, and so he suffers daily.

And Todd is but one example of what the War on Drugs hath wrought.

In going through material about Todd to write this Introduction, I came across the transcript for *Politically Incorrect* the night Todd appeared as a guest. The host and creator of the show, the marvelous Bill Maher, dedicated the entire show to one topic, medical marijuana.

I thought there was no better way to introduce Todd than to print the verbatim transcript of



the show.

The other guests were Woody Harrelson, coming on the show to backup his buddy, Todd; Dr. Drew Pinsky, most often seen on MTV telling callers masturbation is okay as long as they wear a condom; and the leader of a band called Dixie Chicks, Natalie Maines.

I am certain Ms. Maines is a fine musician and composer, and to name her band Dixie Chicks shows that she's just as gritty as heck, but Ms. Maines, unfortunately, is a perfect example of what the DARE program produces—young people with “facts” about drugs that are entirely wrong.

Dr. Pinsky's character you will discover for yourself. In the beginning, you'll see, he keeps returning to the fact that Histiocytosis X is not a cancer, therefore Todd is not really a cancer patient. Dr. Pinsky keeps pressing this point as though he were revealing “the goods” about Todd.

Todd, as you shall see, handles himself very well during this medical Inquisition. In fact, Todd's passion, clarity, and wisdom got him invited to be on Dr. Pinsky's radio show, where for two hours Todd was treated by Dr. Pinsky with considerable respect—some might say admiration.

Todd's ability to work such medical miracles is why Todd is so hated by the government.

Todd tells the truth about medical marijuana; the government tells only lies. Todd can communicate about medical marijuana; the government is as eloquent as Barry McCaffrey. Todd knows



*Planting Potatoes*

how to grow medical marijuana; the government knows, too, but it ain't writin' any books about it.

Todd has.

I am happy to risk life in prison for the honor of saying, "I was Todd McCormick's first publisher."

—Peter McWilliams

July 21, 1998



"You're working in the prison garden because you grew your own medicine? You're shittin' me?"

*P.S. Two days after completing this Introduction, I was arrested by the federal government as the kingpin in a conspiracy, with Todd, to grow and sell marijuana. I spent one month in federal custody while my mother and brother put up their houses to raise the \$250,000 bail. To paraphrase Oscar Wilde, the way America treats her sick people, she doesn't deserve to have any.*

*The informants were revealed by the federal government in its papers as Scott Imler and two of his employees, both named Jeff, at the Los Angeles Cannabis Club, now the Los Angeles Cannabis Resource Center. In exchange for government immunity, they testified against Todd and myself. Their operation is still open, the only cannabis club in California that has been completely free of government intervention.*



*“As always, satirized for your protection.”*

***Transcript of  
Politically Incorrect  
May 15, 1998***

Bill: Hi, I'm Bill Maher, and tonight we're going to dedicate the program to California's Proposition 215, which says that Californians can use marijuana for pain. It's only a coincidence that it was enacted the same year as the Fleetwood Mac reunion.

*[ Laughter ]*

California says it's the law. The Federal Government says it isn't. So they split the difference, it's legal, but if you do it, you're going to jail.

*[ Laughter ]*

Well, tonight my guests are an addiction specialist, a marijuana activist, a country and western singer and a movie star. Me? I'm just here to make sure it's all fair, and partial, and as always, satirized for your protection.



“One of the country's most controversial medical marijuana activists, Todd McCormick.”

[ Cheers and applause ]

Bill: Let us meet our panel on our special show. He's an actual medical physician and the host of MTV'S *Loveline*, Dr. Drew Pinsky. One of the country's most controversial medical marijuana activists, Todd McCormick. Her band is Dixie Chicks, her CD is *Wide Open Spaces*, Natalie Maines. And finally, this guy's an activist for a lot of causes. He dabbles in acting. Woody Harrelson came by.

[ Cheers and applause ]

Well, as you probably know, tonight, it's pretty much a one-topic show because we have one of the, as I said in the introduction, a leading medical marijuana activist here, that is Todd McCormick. And medical marijuana has been a hot-button issue, not only in this state, but all across this country. It was passed here in something called Proposition 215. I believe it was the November '96 election where the people of this state said, by a pretty sound majority, that they believe that if you are suffering from cancer, is usually what they use it for, and marijuana helps, you can have this drug available to you. Well, Todd has been testing this and has pretty much landed his ass in jail for doing it.

[ Laughter ]

And I know you guys [indicating Dr. Pinsky and Natalie] are against this, so I just want to start this discussion and say, this poor guy has had cancer since—how old were you?





Todd: “Medical marijuana gave me a regained appetite. It gave me a better mental clarity. It made me feel better. It improved the way I felt about life.”

Todd: Since I was two. Ten times.  
Bill: Since you were two?  
Todd: Since I was two.  
Bill: And at some point, your mother gave you a joint, and you said it relieved all the pain?  
Todd: It was amazing. Actually, I was nine years old. I had cancer in soft tissue between my left lung and my heart. I was given six months to live. As a last-ditch effort, my mother gave me some marijuana. She'd read in *Good Housekeeping* and thought it might help.

Bill: In *Good Housekeeping*?  
Todd: Of all things. Yeah, yeah.  
Bill: Are you serious?  
Todd: In the doctor's column, yeah.  
Bill: In the doctor's column of *Good Housekeeping*.  
Todd: Yeah, I think it was February of '78, actually.

[ EDITOR'S NOTE: The Family Doctor column in the February 1978 issue of *Good Housekeeping* reads: “As research proceeds, scientists are finding that the major active ingredient in marijuana—tetrahydrocannabinol or THC—may be highly valuable in treating such conditions as glaucoma, asthma or even terminal cancer.” ]

Todd: And the doctor said to my mom, “He has nothing to lose.” Medical marijuana gave me a regained appetite. It gave me a better mental clarity. It made me feel better. It improved the way I

felt about life.

Dr. Pinsky: Did you have a firm diagnosis then?

Todd: Yeah. Yes, I've had cancer...

Dr. Pinsky: Because Histiocytosis X, which is what I understand you have, is a pretty benign condition.

Todd: It was coming on like machine gun fire, actually.

Dr. Pinsky: And so really, it's not really so much, for you, been the cancer.

Todd: It helped me with the treatment.

Dr. Pinsky: Right. It's not really a cancer—that isn't really technically a cancer, even. It's sort of a benign, it's a relatively benign tumor of childhood.

Woody: Yeah, but when doctor's give him six months to live...

Dr. Pinsky: Well, that's why I'm so surprised, because it is usually a self-limited disease. It goes away on its own.

Todd: Right. Up until '85, they treated Histiocytosis X as a cancer. I've had radiational therapy, chemotherapy, surgery...

Dr. Pinsky: Yeah, so you had it in the liver, you had it extra—in other organs other than the...

Todd: In the spine, the skull, the hips, I was in a wheelchair.

Dr. Pinsky: But it's been the pain, isn't it,



*"It's not really a cancer—that isn't really technically a cancer, even. It's sort of a benign, it's a relatively benign tumor of childhood."*

that's really been the issue?

Todd: Since I was twelve, I used it for pain relief. Yeah. The top five vertebrae of my spine are fused together and one hip stopped growing when I was eight, all due to medical treatment for what they thought, at the time, was cancer.

Bill: I think the issue is if something is helping a guy who's sick, where does the government get the balls [bleeped on the air] to say, "You can't have it"?

[Cheers and applause]

Todd: Well, it's interesting. You know, even during alcohol prohibition, Bill, the medical use of alcohol was never prohibited. You could always walk into a pharmacy and pick up medicinal alcohol. It seemed like...

Dr. Pinsky: But don't kid yourself. The government's involved in the patient/physician relationship all over the place. I mean, the insurance companies are involved in it. The government's involved in it. The legal system is involved in it.

Bill: So?

Dr. Pinsky: I don't think it's a good thing. I'm with you.

Natalie: I'm back at the beginning. Did you say you have mental clarity because of pot?

Todd: Absolutely. Well, when you're stressed out and you're going through all these types of medical treatments, you can really feel down.



*"If something is helping a guy who's sick, where does the government get the balls to say, 'You can't have it'?"*

*[Natalie laughs at Todd's comment]*

Dr. Pinsky: But here, I think we have to be very, very careful of what we're talking about.

*[Natalie is still laughing at Todd]*

Bill: Wait a second. Why is that a joke to you?

Natalie: Because I don't believe that. You know, I went to high school with people who smoked pot four and five times a day, and they were sitting on their butts. They didn't have mental clarity. And, you know, is it one of those things where, "I drive better under the influence of pot"?

Bill: We're not talking about driving now.

Natalie: So you don't drive?

Bill: I mean, maybe that's you and your friends. I mean, Woody, I know, has better mental clarity under it.

*[ Laughter ]*

Woody: *[with great mental clarity]* There's no question about that, Bill. Thank you.

*[ Laughter and applause ]*

Bill: I mean, I think the issue is, if he's in pain and the populous decides that they think it's okay for medical patients to have it, then where does the government get off saying, "You can't have it"?

*[ Applause ]*

Natalie: I agree with that, except that I was talking to Dr. Drew [Pinsky] backstage, and he was saying that it's not proven. There's no medical cases that it's proven.



Woody: "There's no question about that, Bill. Thank you."

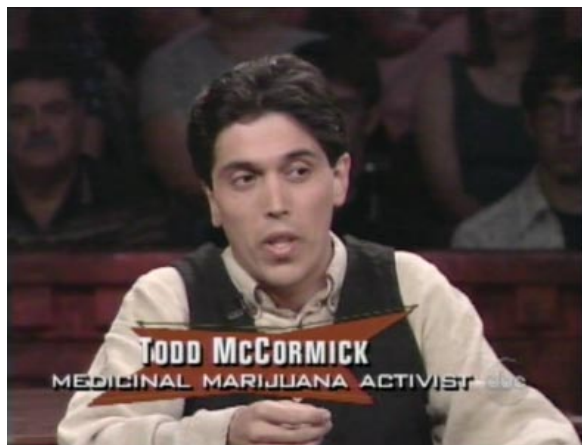

*Todd: “The Society for Neuroscience—this was just front-page news in the L.A. Times—said that over 97 million people would benefit from the chemicals derived from or similar to the ones found in marijuana.”*

*Dr. Pinsky: “But we don't know. That's the problem. We need the research. We really need the research.”*

*[ED NOTE: The report from the Society for Neuroscience Dr. Pinsky obviously has not read was released in October 1997. Summing up the research work of four major universities, it began, “New research shows that substances similar to or derived from marijuana, known as cannabinoids, could benefit more than 97 million Americans who experience some form of pain each year.” The complete text of the Society for Neuroscience report is at [www.marijuanamagazine.com/toc/articles/manalgesic.htm](http://www.marijuanamagazine.com/toc/articles/manalgesic.htm).]*

Dr. Pinsky: And really, that's the real crux issue, is that there's difficulty getting the research done. And that's really where there's been a serious problem.

Todd: But it's been the government that's prohibited the research.

Dr. Pinsky: I think everyone's pretty much in agreement that the research needs to be done. The problem I have with marijuana...

Todd: Yeah, but, I mean, there is a lot of research.

Dr. Pinsky: He's not dying of cancer. It's not like we're going to give him something to prolong—in fact, it may be the wrong drug for him because it's chronic pain that he has.

Todd: The Society for Neuroscience—this was just front-page news in the L.A. *Times*—said that over 97 million people would benefit from the chemicals derived from or similar to the ones found in marijuana. Potentially, 97 million Americans...

Dr. Pinsky: But we don't know. That's the problem. We need the research. We really need the research.

Bill: But until the research is done, people are suffering. And...

Dr. Pinsky: I got to tell you something. Because I have tons of clinical experience with this stuff.

Bill: But he has tons of actual experience.

*[ Cheers and applause ]*

Dr. Pinsky: But, in fact, though, Todd—and please, Todd, I don't mean to disparage your condition, but your real condition now is chronic pain?

Todd: Right.

Dr. Pinsky: And one of the axioms of chronic pain is getting off all substances before the—and utilizing other than medicinal approaches to the treatment of chronic pain, because activation of the reward system....

Bill: You've got to be kidding. This whole country is dedicated to taking a pill for everything

[ Applause ]

Dr. Pinsky: JAMA [*Journal of the American Medical Association*] just published an article this week about adverse drug side effects being the fifth —between fourth and sixth—leading cause of death for people in hospitals.

Todd: It was just all over the news that prescription drugs kill over 100,000 people a year, also. Cannabis, on the other hand, hasn't taken a life in its 5,000-year history.

[ Applause ]

Dr. Pinsky: That is my point. I've gotta tell you. If you hear—it has, unfortunately, and please, bear with me. 'Cause I run an addiction program, and I have to deal with marijuana addiction every day. And the fact is that the incidence of suicidality of the first six months of marijuana abstinence is substantial. And people don't know that.

Bill: I don't think it's the marijuana, it's the fact that they miss it so much.



*“Cannabis, on the other hand, hasn't taken a life in its 5,000-year history.”*





Woody: “Should we round up everybody who goes to Dunkin' Donuts and throw 'em in jail?”

Dr. Pinsky: They do. Absolutely. It's a very serious reality. And in fact, people who get into marijuana addiction years down the line already get depressed. They get irritable. And usually, they switch to speed...

Natalie: Which is why, until the drug—until there is enough research, it is an illegal drug.

Bill: Enough research.

Natalie: But that research has to be out there. What about years ago when people didn't think cigarettes did anything to you? Now we found out you die of it and people die of it. I agree with that.

Woody: Coffee is a legal drug.

Natalie: And it shouldn't be.

Woody: And sugar's a legal drug. And they're all damn bad for you. Should we round up everybody who goes to Dunkin' Donuts and throw 'em in jail?

[ Cheers and applause ]

Natalie: We should, as far as cigarettes.

Bill: I have to take a commercial. We'll come back to Dunkin' Donuts.

[ Applause ]

Bill: All right, we were talking about medical marijuana and marijuana in general. And some people watch this and say “Oh, they're talking about drugs, and that's what they care about.” To me, it's fundamentally an American issue, about what we want in this country, and what this country means. Do you have the freedom to do what

you want as long as it doesn't hurt somebody else? That, to me, is what America is about.

[ Applause ]

That, to me, should be a conservative stand-point. But it is not. Now, you had mentioned, you said marijuana addiction. You talked about a clinic that you were involved in.

Dr. Pinsky: Yes. Yes.

Bill: I've never heard those terms together.

Dr. Pinsky: You know what? I thought that somebody would bring that up. So I just pulled out the first two quarterly *Journals of Addiction Disease*. And in here, a physician—one of them has a physician paper on how to handle marijuana addiction, and what the American Society of Addiction Medicine's position is on marijuana.

Bill: Well, what is addiction, doc?

Dr. Pinsky: Addiction is the progressive use in a biologically prone individual in the face of consequences. If somebody keeps using even when they need to stop and want to stop.

Bill: So, food can be an addiction?

Dr. Pinsky: Well, it depends on...

Bill: I bet food kills more people than pot.

[ Applause ]

Woody: Amen, brother!

[ Applause ]

Dr. Pinsky: But stay with the—I'm not defending—because I'm quasi-anti-prohibition. I



“Amen, brother!”



think prohibition basically fuels the crime syndicate and doesn't do much for people that use drugs, except it doesn't help addicts contain their behavior, and it allows for abuse of substances for adolescents.

Bill: But why is it—some things are not addictive, I assume, we could say.

Dr. Pinsky: I am anti-misinformation on this drug. Unfortunately, I hear the audience snicker when I talk about my experience with this drug in dealing with people who become addicted and looking at the biological concept.

Woody: I don't think the issue is whether or not people become addicted because I think it's obvious people become addicted. You know, there's a lot of potheads in the world. But the issue is whether or not we should be throwing them in jail if there's such a thing as a victimless crime. And we spend \$50 billion a year on victimless crimes in this country.

[ Applause ]

Now, the question is, should we be throwing these people in jail? Should we be—you know, I don't quote George Bush much...

[ Laughter ]

...but he said something I like. He said, “If we've learned anything in the last quarter century, it is that we cannot federalize virtue.” And that, to me, is what's going on here. The United States government is trying to tell us what's right and what's wrong when no one's being hurt by it. If

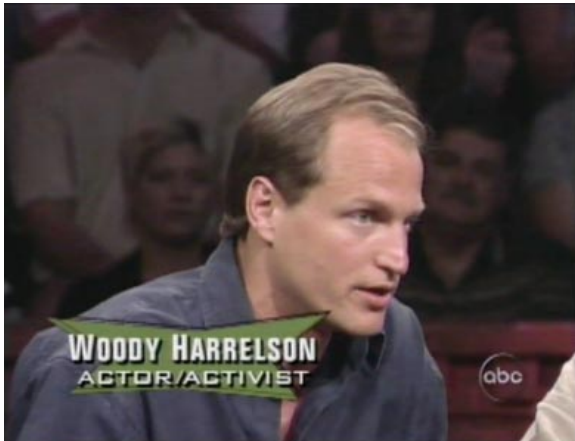

*“We spend \$50 billion a year on victimless crimes in this country.”*

you're not hurting the person or property of a nonconsenting other...

Bill: But he is being hurt by not being allowed to have even Marinol, which is the prescription version of it.

Todd: Right. Yeah, I just spent 11 days in jail because the judge decided that I shouldn't be allowed to use prescription Marinol.

[ ED NOTE: McCormick was, in fact, held eleven days without a hearing, illegal under federal law. ]

Dr. Pinsky: Does Marinol work for you?

Todd: Actually, it does. You know, what happens when I have chronic pain is I can't sleep at night. I wake up chronically fatigued. I lose my appetite. It works well.

Bill: [to Natalie] And it has nothing to do with who you got baked with in high school.

[ Laughter ]

Natalie: Yeah, but the point to that was that it doesn't not do anything to you. And it does affect other people. Your senses get altered, you get behind the wheel of a car, just like you do alcohol, and you put the lives of other people in danger.

Bill: Yeah. But alcohol is not outlawed. You can't outlaw things just because people might screw up with them.

Natalie: No. But now that something is illegal, you can't say you can do it just because alcohol is legal. So let's bring a lot of other things legal that hurt other people because we already have



*"Yeah, but the point to that was that it doesn't not do anything to you."*

one.

Bill: Using Democracy doesn't hurt other people. It helps people.

Woody: Is this a free country? Do you really think it's a free country?

Natalie: Yes. And my mother had cancer, and I have to honestly say that if that helped her and it was legal, then that would be okay. But my worry is...

Todd: Did she try it?

Natalie: No.

Todd: Why?

Natalie: She didn't have to because her cancer didn't get that far.

Todd: It didn't get that far.

Natalie: Right.

Todd: But now the people who have had cancer get that far, the people with AIDS, the people with glaucoma, how about them? The government supplies one of my dearest friends [*Elvy Mussika*] with 300 marijuana cigarettes for the past ten years because she has glaucoma.

Natalie: But what about when you...

Todd: It's the only thing that's helped her see. Should she go blind because it's illegal?

Natalie: How about this? How about, since you have to smoke it around seven times a day, like all the other addictive drugs in the hospital, why don't you go to the hospital, smoke it seven



*"How about this?"*

times a day in a room with a doctor so that you don't go get it at a drug store and pass it off to all your friends?

Todd: Do you know how ridiculous that just sounded?

*[ Laughter, cheers, and applause ]*

And that's like saying, "Go to the hospital because you've got to take your Prozac."

Natalie: Yeah, 'cause I don't want kids getting that, too.

Bill: Yeah, Prozac.

Todd: When I was 9, I never shared medical marijuana with my friends.

Bill: Kids take Prozac.

Todd: I did very well in school. It didn't affect my friends. It affected me.

Bill: Your experience is that you saw...

Natalie: You were sick. Not all kids are sick.

Todd: And they weren't, and I saw a difference.

Bill: *[to Natalie]* But why should everybody suffer because the people you went to high school with used it to eat Cheetos and watch cartoons?

*[ Applause ]*

Natalie: It's not the people I went to high school with, it's kids...

Bill: Not everybody uses it that way.

Natalie: But people do, so let's make it more



Todd: "Do you know how ridiculous that just sounded?"



Do you know how ridiculous that just sounded? (reaction)

available to them.

Bill: But people do? People also drive badly, should we outlaw cars?

[ Laughter ]

Dr. Pinsky: Let me turn this a little bit and say that I have yet to have a request for marijuana prescription from somebody who is not a marijuana addict. I have yet to experience that because...

Todd: Whoa, whoa, whoa.

Bill: This term [*marijuana addict*] I do not understand.

Todd: This term is ridiculous.

Dr. Pinsky: Because, well, let me explain. Hold on. Hold on. Because people who have this predisposition have much more of a euphoric effect from the drug. And I have made cases that we ought to find out what that euphoragen is and take that out, and see if people still want to use this drug for medicinal purposes.

Woody: Why throw people in jail because they're feeling euphoria?

Dr. Pinsky: But—right. But wait a minute, this is the question—wait a minute, this is the question...

Bill: Hey, let's take the good taste out of chocolate ice cream, doc, while we're at it.

[ Laughter ]

Bill: All right. This is your record, Dixie Chicks, great record. And I assume it's all done



Woody: “Why throw people in jail because they're feeling euphoria?”

sober.

Natalie: Except for the last song.

Bill: Except for the last song. What happened there?

Natalie: A little wine.

Bill: A little wine?

Natalie: No pot, though.

Bill: Well, why is wine any different? I mean, creativity is enhanced by certain things that nature, God, put on the Earth. There's any number of bands who would testify that they were not, as you say, induced to just zone out when they smoked pot, but they actually had their creativity enhanced. You don't think that that's possible?

Natalie: No.

Bill: Really, then you're just...

Natalie: You just listen to the dobro part on that last song, and it's really out of tune.

Bill: You don't think anybody ever had a different experience than the one you characterize with marijuana?

Natalie: Yes. But what about every experience I bring up, it's specifically his. Or do you have cancer? Have I missed the bulletin?

Woody: I don't have cancer, but I think I have a right to smoke pot, as much of a right as someone has to take Prozac and as much of a right as someone has to smoke cigarettes.

[ Cheers and applause ]



Woody: "I don't have cancer, but I think I have a right to smoke pot, as much of a right as someone has to take Prozac and as much of a right as someone has to smoke cigarettes."





Woody: “To quote Thomas Jefferson, ‘I think the government that governs best governs least.’”

Dr. Pinsky: All right. Here's the deal, though. Really, what we're talking about is, none of us really disagree that if somebody with a terminal condition or even a chronic condition that would be improved by marijuana should categorically not be allowed to use it. But I think the question we're kind of zeroing in on here is, does prohibition work, and do we want a government that utilizes prohibition in our society?

Todd: Well, when we had alcohol prohibition, we saw crime increase, we saw gangs...

Dr. Pinsky: If you look at the facts, if you look....

Woody: To quote Thomas Jefferson, “I think the government that governs best governs least.”

[ Applause ]

Todd: And then—and then, you know, what kind of resources are being wasted on this drug war right now? I was lookin' at statistics last night. There's over \$17 billion this year cast away. That doesn't include the IRS drug budget, the DEA's drug budget, the FBI's drug budget, which is close to \$21 billion.

[ ED NOTE: Plus another \$19 billion spent by state and local antidrug authorities, for a total of \$40 billion. ]

Dr. Pinsky: Oh, I agree with you. But here's my concern is that if we, say, start to legalize various abusive substances and the government gets funds from that, I would be in favor of it if they would use those funds to help treat and educate

people about drugs and addiction. The problem is, what do you think would happen to those monies? They would very quickly be siphoned off into God knows what.

Todd: Well, wait a minute. Wait a minute. Wait a minute.

Bill: So the better answer is to send crop-dusting planes to Colombia?

Todd: Yeah, right.

Dr. Pinsky: But the better answer is to contain this. And I think that's what our society is trying to do, is try to help...

Todd: But you're not containing it by having a drug war. We are feeding the fire, to say the very least. I mean, a person, a family has to pull teeth, sweat bullets, to be able to save up enough money to put their kids through college. And it's so hard to procure a loan and save \$14,000 a year just to get money to go to school. But, if you're put in a desperate situation because you have no education, there's \$16,000-to-\$33,000 already put aside to incarcerate you. You know, what are we doing for the children with this drug war?

[ Applause ]

Natalie: But the point is that it's against the law. You get put in jail because you're breaking the law.

Bill: But the law is made by the people, and the people of this state and many others said they don't think it's a just law. They have a sense of what this country is about, which is freedom to do



Todd: "But you're not containing it by having a drug war."





whatever you want to do if it doesn't hurt somebody else.

Woody: Halleluja, brother.

[ Applause ]

Dr. Pinsky: I have to counter with an Abraham Lincoln quote, which is "The majority cannot decide what the majority cannot decide." Meaning that sometimes...

Bill: Why should...

Woody: I got another Abraham Lincoln quote -- "I've noticed folks with very few vices have very few virtues."

Natalie: Hey, I've got a Clinton quote: "I did not inhale."

Todd: And now he's a President, but he tried it. Should we imprison him for trying it? And that's what this really should be all about. We are sending people to jail. The government has been trying to put me in jail for ten years to life because I grew my own medicine.

Woody: And he's never hurt anybody.

Todd: No. Nonviolent...

Dr. Pinsky: But I read what you were growing. That wasn't all for you, was it?

Todd: Yeah, actually, it's research. I mean, now that the laws have changed, anyone with half a mind is going to want to experiment with a plant that has as much genetic diversity as dogs. I mean, if I was allowed to grow dogs, I wouldn't grow Chihuahuas to pull a dog sled. And this is the situ-

Todd: "The government has been trying to put me in jail for ten years to life because I grew my own medicine."

Woody: "And he's never hurt anybody."

ation we're in. I want to breed the plants that make the best medicine.

[ Applause ]

Bill: Now, how can you say this man is not thinking clearly?

[ Laughter ]

Could a man make an analogy like that if he wasn't thinking clearly?

[ Applause ]

Dr. Pinsky: You're not using it continuously, are you? You're using it intermittently.

Todd: When I used marijuana medicinally, I found actually it was quite the reverse. If I used it spontaneously, like a little here and there, I would get high, come down, I'd still be in pain. If I would use it from when I woke up to when I go to sleep, I would not be in a foggy state. I would be able to think clearly. You would never be able to tell if I was smoking or not smoking. And my pain would decrease. I would sleep normally, eat normally.

Dr. Pinsky: Do you use intermittently? That's a no...?

Todd: No. No. I use it all the time. But right now, I'm under severe drug testing because the government is acting as a doctor. Even though I have no less than five recommendations from some of the top American physicians on the subject, the government is saying, "We know best." And that's not Democracy. That's more of a mirror of fascism than it is anything that this country...



*Todd: "If I would use it from when I woke up to when I go to sleep, I would not be in a foggy state. I would be able to think clearly. You would never be able to tell if I was smoking or not smoking. And my pain would decrease. I would sleep normally, eat normally."*

*[Applause]*

Bill: They can't deliver the mail, and they're telling him how to run his health regimen?

*[ Applause ]*

It just seems wrong. Okay. We have to take a commercial. We'll come back.

*[ Applause ]*

Bill: Okay. Last time we talked to you, you wanted to say something about Proposition 215.

Dr. Pinsky: I was really offended by 215. As you know, what I am mostly against is misinformation. And 215, to me, seemed like a sham. It was some sort of Trojan horse, concocted to try to get people—using the sympathies of people about individuals with chronic illness, to try to cram this thing into legality.

*[ED NOTE: The conservative California legislature passed legislation in 1994 and 1995 providing medical marijuana for patients. It was vetoed twice by Republican Governor Pete Wilson at the urging of his Attorney General, Dan Lungren. The Proposition 215 initiative in 1996 was tried only after all other political avenues had failed.]*

Todd: No, I started a compassion club in San Diego because I've seen people going blind, dying of AIDS in front of me, and nobody's helping them. And the drugs that you can prescribe don't work. These people shouldn't suffer waiting for you to change your minds and laws.

Dr. Pinsky: Marijuana doesn't work that well. That's misinformation, too. It's a weak drug. It's



*“They can't deliver the mail, and they're telling him how to run his health regimen?”*

not a very potent drug for these sorts of things. For you...

Todd: It doesn't stimulate appetite?

Dr. Pinsky: It stimulates appetite, but a lot of things—Megace stimulates appetite. That's what's indicated now for AIDS wasting, as a matter of fact.

*[ED NOTE: Megace is synthetic progesterone, a female sex hormone. According to the manufacturer, the side effects of Megace include nausea, indigestion, fluid retention, vaginal bleeding, muscle cramps, skin rashes, breast changes, breast milk reduction, mood changes, tiredness, headaches, nervousness, sleeplessness, drowsiness, dizziness, and low moods.]*

Woody: The question is, should the government have a hand in victimless crimes?

Dr. Pinsky: We're back to that again.

Woody: Should we be thrown in jail because we're not wearing a seatbelt?

Dr. Pinsky: This is the issue that we sort of stall out on.

FADE OUT



Woody: "The question is, should the government have a hand in victimless crimes?"

I thank you as well for the seeds, as for the pamphlets which you have had the goodness to send me. The artificial preparation of Hemp, from Silesia, is really a curiosity — and I shall think myself much favored in the continuance of your correspondence, when I have more leisure than at present (just at the winding up of a long laborious & interesting session of Congress) I may write you more fully than it is in my power to do at present relatively to the subjects you have touched upon.

This Letter & another which I have taken the liberty of putting under cover to the Earl of Buchan, is directed to the particular care of the American Minister in London. I wish them safe to hand, & that you would do me the justice to be assured of the esteem with which

I am, Sir, &c.  
G. Washington

“I thank you as well for the Seeds as for the Pamphlets which you had the goodness to send me. The artificial preparation of Hemp, from Silesia, is really a curiosity; and I shall think myself much favored in the continuance of your correspondence [sic].” May 26, 1794

—President George Washington.

## CHAPTER ONE

### *Medical Marijuana: A Brief History*

To its ongoing shame, the United States government still denies that medical marijuana has any benefit whatsoever.

But the truth is getting out there. Not since prohibition began in 1937 has there been such a large body of knowledge. Millions now know that medical marijuana provides safe, effective relief for a wide array of ailments, from chronic pain and migraines to glaucoma, epilepsy, multiple sclerosis and the debilitating effects of chemotherapy and AIDS.

*And I think that's what  
 Nature grows them herbs for.  
 They was put on earth  
 for man to use.  
 The animals have  
 an instinct for 'em.  
 That's why cats go for catnip.  
 The women used to  
 take that hamp [hemp]  
 and steam the leaves and  
 make kind of a plaster out of it.  
 It was supposed to be good for  
 takin' out inflammations,  
 and it was, too.*

ORAL HISTORY

FROM THE LIBRARY OF CONGRESS,  
 Circa 1930

Marijuana is not physically addicting, nor does it kill like alcohol and cigarettes. While more than 100,000 people a year die from legal prescription drugs, not a single person in recorded history has ever died from medical marijuana.

When the safety record of marijuana is compared to other legal substances, medical marijuana prohibition makes no sense at all.

Annual drug and alcohol deaths in the United States:

Tobacco .....	450,000
Alcohol .....	100,000
Prescriptions.....	100,000
Aspirin.....	1,000
Marijuana.....	0

Yet the politicians refuse to budge and the Drug Czar, retired General Barry McCaffrey, thinks he knows better than your doctor what's good for you.

Among the many myths McCaffrey and his cronies spread is that medical marijuana is an unproven drug that hasn't undergone rigorous scientific scrutiny. To the contrary, the federal government has spent



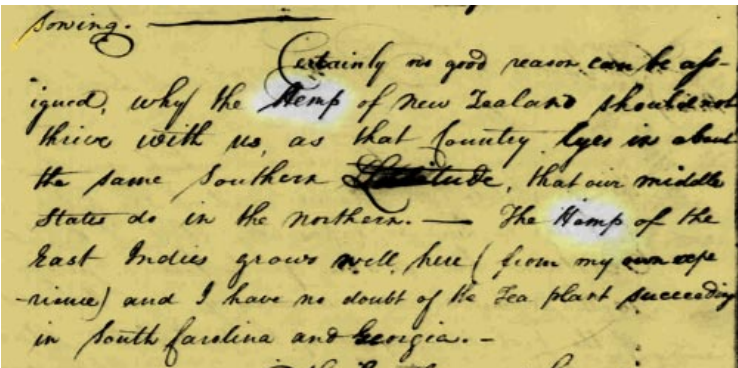

“Certainly no good reason can be assigned why the Hemp of New Zealand should not thrive with us, as that country lyes [sic] in about the same Southern latitude, that our middle States do in the Northern. — The Hemp of the East Indies grows well here (from my own experience) and I have no doubt of the Tea plant succeeding in So. Carolina and Georgia.”

LETTER FROM PRESIDENT WASHINGTON

TO JOHN SINCLAIR,

December 10, 1796

200 years before the passage of 215

*ED NOTE: John Sinclair, of course, is also the name of one of the foremost marijuana freedom fighters of the 1960s and 1970s. He spent several years in prison on marijuana charges. He currently lives in New Orleans and has a twice-weekly jazz radio show on WWOZ, online at [www.wwoz.org](http://www.wwoz.org).*

\$70 million on scientific research in the last quarter-century without proving that medical marijuana is a dangerous drug.

In truth, this plant you are about to grow has been a valued natural medicine for thousands of years, prescribed by the greatest medical minds of their day.

Relics discovered in ancient pyramids indicate that Egyptian physicians prescribed medical marijuana for childbirth. The first recorded evidence of medical marijuana use appeared over 4,700 years ago in the pharmacopoeia of Shen Nung, one of the fathers of Chinese medicine. In Persia 2,700 years ago, the prophet Zoroaster wrote a sacred text listing 10,000 medicinal plants, with medical marijuana at the top

Until the U.S. government made marijuana its official name in 1937 (sometimes spelled “marihuana”), the plant had been known for eons as cannabis or hemp. Its country of origin is not positively known, but is generally believed to be the mountainous districts in the extreme north of India.

The most versatile plant on the planet

*Long ago when these ancient Grecian  
Temples were new,  
hemp was already old  
in the service of mankind.  
For thousands of years,  
even then,  
this plant had been  
grown for cordage and cloth  
in China and  
elsewhere in the East.  
For centuries prior to about 1850,  
all the ships that sailed  
the western seas  
were rigged with  
hempen rope and sails.*

*Opening Narration of the  
U.S. Department of Agriculture's 1942 film*

**“HEMP FOR VICTORY”**

(we'll get to that later), it spread westward through the Mid-East and Europe and southward through the Sub-Continent.

The similarity of its name in various languages confirms its universal use.

In the Sanskrit it is called *goni, sana, or shanapu*; Persia, *canna*; Arabic, *kannehor kinnub*; Greek, *kannabis*; Latin, *cannabis*; Italian, *canapa*; French, *chanvre or chanbre*; Danish, *kamp or kennep*; Lettish and Lithuanian, *kannapes*; Slavic, *konopi*; Scandinavian, *hampr*; Swedish, *hampa*; German, *hanf*; Anglo-Saxon, *haenep*; and English, *hemp*.

Even though the Roman Catholic Church banned medical marijuana during the Dark Ages because users acted irreverently toward authority (a side effect I happen to enjoy), medical marijuana was rediscovered by scientists during the Enlightenment and became a mainstay of European medicine by the 1800s. In the mid-1800s, the father of French psychopharmacology, Dr. Jean-Jacques Moreau de Tours, got remarkable results prescribing medical marijuana for insanity and depression.

By the turn of the century, England was on the cutting edge of Western medicine. Sir William Osler, then the world's most renowned doctor, hailed medical marijuana as the best remedy for migraines. Sir Russell Reynolds gave medical marijuana to Queen Victoria for PMS and other ailments. Writing about medical marijuana in the first edition of the British medical journal *The Lancet*, Reynolds said it's "one of the most valuable medicines we possess." Ironically, Queen Elizabeth would get locked away in the Tower of London today for seeking relief with medical marijuana.

With George Washington and Thomas Jefferson urging patriotic Americans to grow hemp, the plant provided colonists with one of their most important resources for clothing, rope, canvas, and food (the seeds contain all the essential proteins, see Chapter Three).

And don't think it was all for industrial use. The colonists were well aware of marijuana's medicinal qualities. A popular pamphlet published in 1766 called *Abstract from a Treatise on Hemp* included

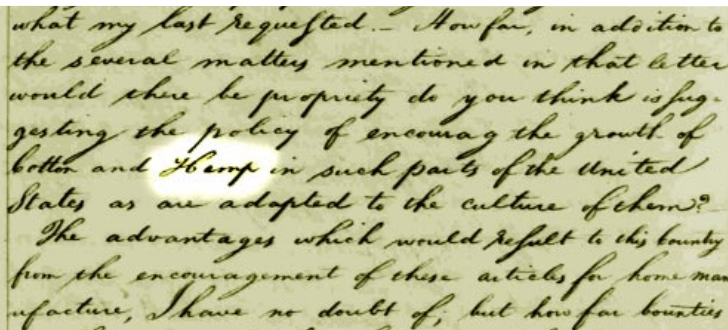

*"How far, in addition to the several matters mentioned in that letter, would there be propriety do you conceive in suggesting the policy of encouraging the growth of Cotton and Hemp in such parts of the United States as are adapted to the culture of these articles? The advantages which would result to this Country from the encouragement of these articles for home manufacturer, I have no doubt of; but how far bounties*

LETTER FROM  
 PRESIDENT GEORGE WASHINGTON  
 TO SECRETARY OF THE TREASURY  
 ALEXANDER HAMILTON,  
 October 14, 1791



Photo of 19th Century medicine bottle from “The Great Book of Hemp” by Rowan Robinson.

these “medical properties.” (Alas, even among the medicinal praise, it unjustly condemns the intoxicating effects of marijuana.)

Taken in an emulsion, it is good against a cough and the jaundice, and also against the gonorrhoea; its oil is recommended as an ingredient in pomatums for the small-pox; and it is laxative. Taken inwardly, or outwardly applied, it has not the dangerous qualities that are ascribed to the whole plant with its leaves; the powder of it mixt with drink, will make those who use it drunk, dull, and stupid; We are told that the Arabians make a sort of wine of it, which intoxicates...

The grain and leaves being squeezed, while they are green, and applied, by way of cataplasm, to painful tumors, are reckoned to have a great power of relaxing and stupifying...the powder of its leaves, taken in drink, is reckoned good for dysenteries...

It is very good against the gout, and other humours that fall upon the nervous, muscular, and tendinous parts. It abates inflammations, dissolves tumors and hard swellings upon the joints. Beat and pounded in a mortar, with butter, when it is still fresh, it is applied to burns, which relieves greatly when it is often renewed.

In the 1800s, medical marijuana became this country’s No. 1 analgesic and made up half of all medicine sold, with no

*The scientific case for  
medical [marijuana] use  
keeps growing stronger.*

*Far more dangerous  
psychoactive drugs,  
like morphine,  
are successfully allowed  
in medical use.*

*Somehow marijuana has become  
a symbolic or political hard line  
to be maintained by antidrug believers  
regardless of human cost.*

*The costs will mount  
until the public can organize itself  
to insist that those who urgently need  
this medicine  
can obtain and use it legally.*

AIDS T<sub>TREATMENT</sub> NEWS

January 23, 1998

incidents of abuse reported.

The first extensive study of medical marijuana in the U.S. was completed in 1860 by the Ohio Medical Society. Physicians reported success in treating stomach pain and gastric distress, psychosis, chronic cough, gonorrhoea and neuralgia.

At the turn of the century, the drug began to fall into disuse. Cannabis was difficult to store and its extracts were variable in their effect. As new synthetic drugs were developed in the early 1900s, cannabis was less widely used but still available by prescription and in some over-the-counter preparations.

The modern Dark Ages began in 1937 when the federal government banned medical marijuana for reasons that remain obscure to this day. All knowledge of the plant was dropped into a black hole and replaced with lies. Medical marijuana was stricken from the U.S. Pharmacopoeia, in which it had held an honored place for more than 100 years. All research was banned except that which was designed to prove *Reefer Madness* was right. And if they couldn't find something bad, they made it up, all

*Present evidence indicates that [cannabinoids] are remarkably safe drugs, with a side-effects profile superior to many drugs used for the same indications.*

*... [The British Medical Association will urge the government to] consider changing the Misuse of Drugs Act to allow the prescription of cannabinoids to patients with certain conditions causing distress that are not adequately controlled by existing treatments...*

*[W]hile research is underway, the police, the courts, and other prosecuting authorities should be made aware of the medicinal reasons for the unlawful use of cannabis by those suffering from certain medical conditions for whom other drugs have proved ineffective.*

**BRITISH MEDICAL ASSOCIATION**  
*Therapeutic Uses of Cannabis*  
November 1997

the while suppressing favorable studies and reports. In the last six decades, there was a window of only 10 years in which the federal government allowed legitimate, unbiased scientific studies to take place. From 1966-76, hundreds of studies revealed the therapeutic potential hidden within the plant's hundreds of compounds.

Researchers began getting positive results using medical marijuana in the treatment of glaucoma, anorexia, asthma, nausea, Parkinson's Disease, and spastic muscle disorders. An article in a 1971 medical magazine reported that medical marijuana "is probably the most potent anti-epileptic known to medicine today."

Abruptly, the government banned all research on medical marijuana, reportedly at the urging of the pharmaceutical industry, which rightly feared a homegrown plant that would compete with their highly profitable synthetic drugs.

People are finally rising up against the government's repression of medical marijuana. All over the world, popular movements are underway to allow the sick and dying to use and grow their own.



*In the town where I was born  
Lived a man who sailed to sea  
And he told us of his life  
In the land of submarines.  
So we sailed up to the sun  
Till we found the sea of green  
And we lived beneath the waves  
In our yellow submarine*

## THE BEATLES

*ED NOTE: For those too young to remember, rolling papers in the 1960s were often yellow, and a hand-rolled joint vaguely resembled a submarine—especially after smoking one. “Yellow submarine” became a popular term for a joint. On May 16, 1966, Bob Dylan released “Rainy Day Women #12 and #35” which included the now-famous refrain: “But I would not feel so all alone, everybody must get stoned.” The old folks thought it was a song about repression (“They’ll stone ya when you’re tryin’ to go home. Then they’ll stone ya when you’re there all alone.”), but us youngsters knew getting stoned meant smoking pot. On May 26, 1966, the Beatles ran to Abbey Road studios and recorded their answer to Dylan and their homage to marijuana. When “Yellow Submarine” was released in August 1966, everyone under 30 knew precisely what the fab four were singing about; everyone over 30 didn’t have a clue—but they thought the song had a nice beat and wasn’t too “noisy.” When the Sea of Green technique was developed in the 1980s, a line from “Yellow Submarine” was used to name it. So the song was named after a joint and the Sea of Green was taken from that song.*

## CHAPTER TWO

### *The Sea of Green*

Imagine a room filled with Popsicle-size clusters of medical marijuana flowers gently waving in a fan-generated breeze. It’s the Sea of Green, and it’s the method you’ll be using to grow your plants for a continuous harvest.

The Sea of Green came about in the mid-1980s, supposedly originating in Holland as a commercial growing technique to bring decorative flowers to market

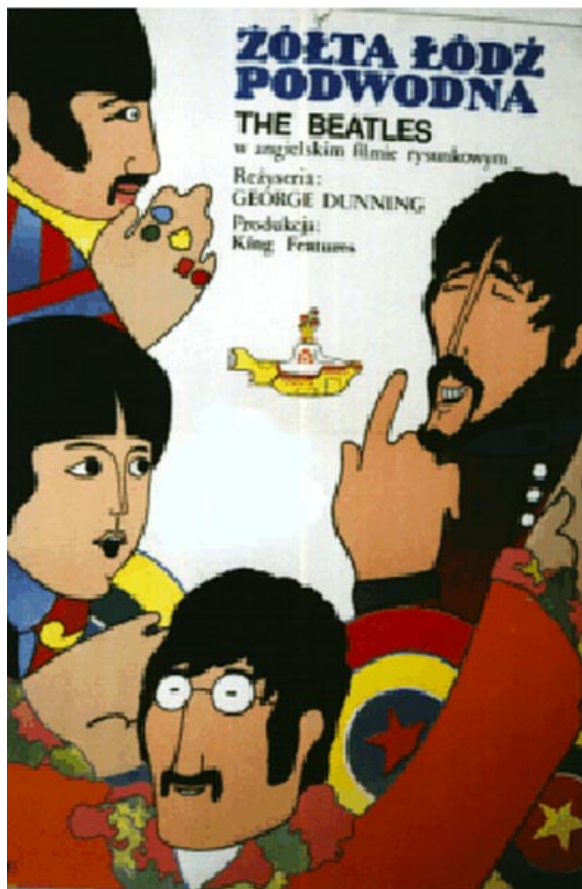

Poster for the film *Yellow Submarine* in Polish

*And our friends are all on board  
Many more of them live next door  
And the band begins to play*

quickly and easily. Some enterprising cultivator thought to apply the process to marijuana and before long, indoor gardens flourished.

Although I'll be using terms like cloning, mothering and flowering in explaining the Sea of Green in this chapter, don't worry about understanding how they work. At this point, just focus on what happens during the Sea of Green process so the coming chapters make more sense.

It's a simple concept, really.

The actual undulating green sea is the end product of a three-step process. The first step is mothering. A Mother Plant is the source for clones and the keeper of the family genes. She lives by herself under 18-to-24 hours of light per day and can live as long as her root space will allow her to flourish, perhaps years and years. The second step is cloning, taking cuttings from mother, rooting them in another room and then quickly growing them into short bushes. The final step is forcing the clones to flower in a room filled with other flowering clones in various stages of budding.

You'll be harvesting a crop every



*As we live a life of ease  
Everyone of us has all we need  
Sky of blue and sea of green  
In our yellow submarine.*

*We all live in a yellow submarine,  
Yellow submarine, yellow submarine  
We all live in a yellow submarine,  
Yellow submarine, yellow submarine*

month and continually resupplying the Flower Room with clones from Mother to keep the Sea of Green in perpetual motion.

Any female marijuana plant can become a mother. How a plant is chosen to be the mother plant is usually decided by her individual character. Some people look for quick-finishing time in flowering and large buds at harvest, others judge a plant's quality by the way they feel after they smoke. I personally look for a plant to exhibit strong growth, good resin production, resistance to bugs and mold as well as a yield and potency consistent with that particular strain.

A clone is a genetic duplicate of a plant taken by cutting off the main stem or one of the branches of a plant and rooting the cutting with rooting hormone. As a duplicate of its mother, the clone will grow and flower in a predictable way, an advantage to you.

The flower room is where the plants bloom and the medicine develops like magic. A Sea of Green is an inspirational sight.

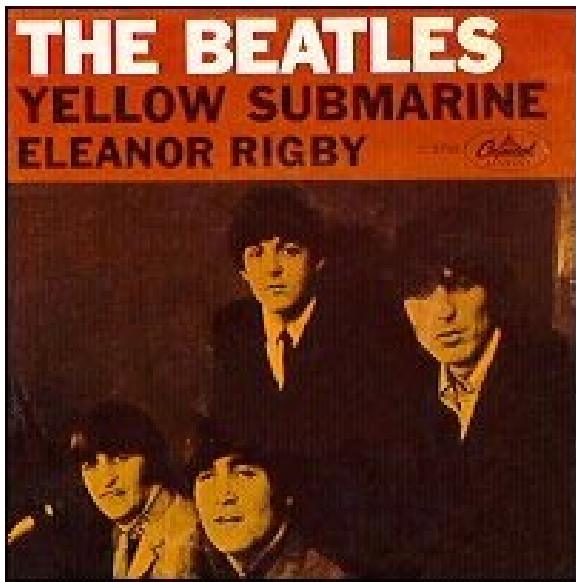

*Yellow Submarine* {McCartney/Lennon} (2:41)

- **Recorded:** May 26, 1966 at Abbey Road, London, England  
with special effects overdubbed June 1, 1966
- **Instrumentation:**  
*John Lennon* - acoustic guitar, background vocal, blowing bubbles through a straw  
*Paul McCartney* - acoustic guitar, background vocal  
*George Harrison* - tambourine, background vocal, swirling water in a bucket  
*Ringo Starr* - lead vocal, drums  
*Mal Evans, Neil Aspinall, George Martin, Alf, Geoff Emerick, Patti Harrison and studio staff* - chorus on fade-out  
*session musicians*—brass band
- *Released as a single in the United States August 5, 1966*

*Where to start?*

If you're ready to grow, you have two choices. One is to start from clones, the other is to start from seeds. Starting out with clones (also called cuttings) puts you several months ahead of the game.

Some people sell clones (\$5-to-\$50 each), while others distribute clones for free. Once a mother plant gets going, she produces lots of offspring, often more than the owner can flower. These owners sometimes spread the extra clones around, Johnny Appleseed style, to medical marijuana patients in need.

If you can obtain one or two clones, these can become your mothers. If you can obtain a larger number of clones, you can start flowering most of them and turn a few into mothers.

In this way you don't have to worry about males (all will be females, as a clone from a female plant is, of course, always a female), your medicine will be uniform in strength and potency (clones replicate themselves exactly), and you will have saved several months in the process.

The people who supply you with



"It's an ever-lovin' SUB-in!" Yes, a Yellow Submarine comic book, circa 1969.

medical marijuana are the best people to ask when looking for clones. When asking about clones, always say you're enquiring for a friend. Never telegraph to anyone you plan to grow yourself. If you later give some clones away, say they were a gift from another.

If you get your clones from an unknown source, study Chapter Six on sexing so you can spot the males should someone sell you unsexed seedlings and not clones.

If clones are not available, it's seed time!

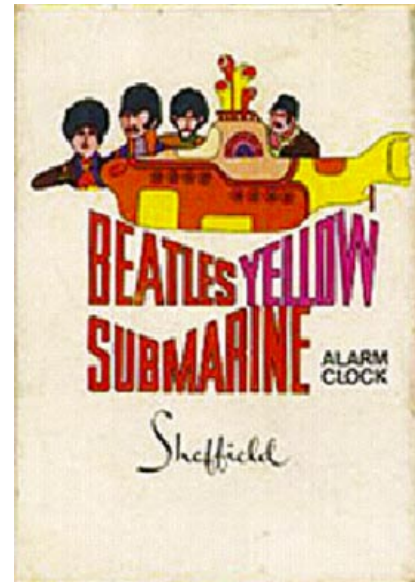



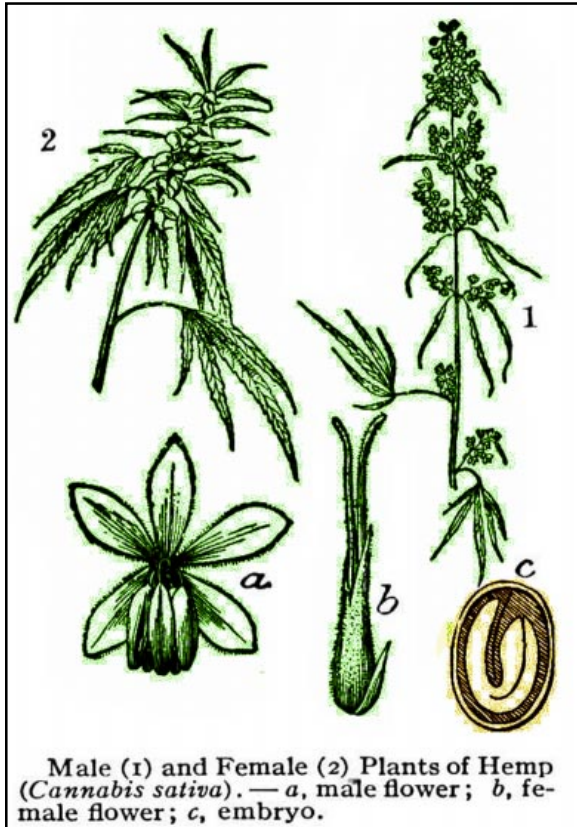

*This old woodcut and its caption pretty much says it all. Note how flowerlike the male flower is (a), while the female flower (b) hardly looks like a flower at all. To make matters worse the “petals” on the female flower are the same green color as the leaves and stems. Learning to tell male from female plants in the early stages of flowering is a skill worth learning.*

## CHAPTER THREE

### *Planting and The Plant*

In a frightening display of judicial ignorance, a California Superior Court judge wondered aloud why sick people needed medical marijuana buyers’ clubs when they could just as easily grow the plant themselves.

“What could be so hard?” he said. “You just dig a hole and throw in a seed.”

All due respect, your honor, but you’re out of order. Kindly pay attention.



*The Family Tree  
of Medical Marijuana*

Before we get to planting, I think you should know a little about this amazing plant. When I myself first learned this information, I was awestruck—but I was also angry that a government would want to eradicate this incredible gift.

The cannabis/hemp/marijuana plant is one of the oldest psychoactive plants known to humanity. Most botanists agree that there are three species: *Cannabis sativa*, the most widespread, is tall, gangly, and loosely branched, growing as high as 20 feet; *Cannabis indica* is shorter, about 3 or 4 feet in height, pyramidal in shape and densely branched; *Cannabis ruderalis* is about 2 feet high with few or no branches. There are also differences among these species in the leaves, stems, and resin.

The chemical compounds responsible for the intoxicating and medicinal effects are found mainly in a sticky golden resin exuded from the flowers of the female plants. The function of the resin is thought to be protection from heat and preservation of moisture during reproduction.

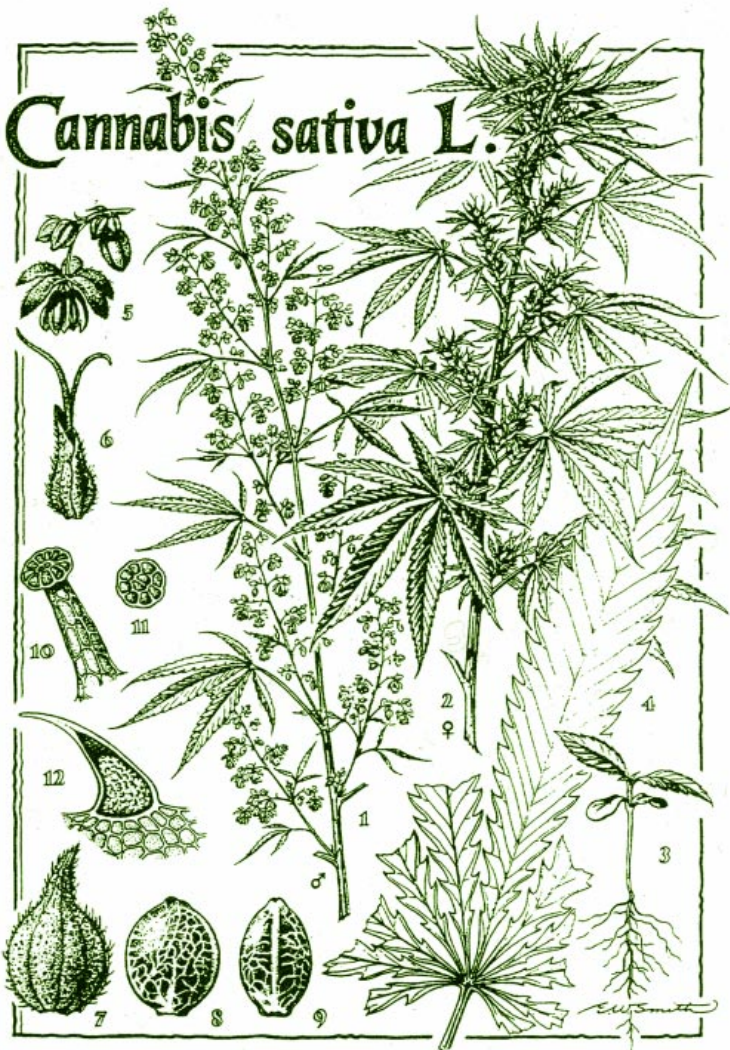

The marijuana plant contains more than 460 known compounds, of which more than 60 have the 21-carbon structure typical of cannabinoids. The only cannabinoid that is both highly psychoactive and present in large amounts is tetrahydrocannabinol, also known as delta-1-THC, delta-9-THC, or simply THC.

### *Hempseed and Health*

Arguably the most versatile plant in Mother Nature's Kingdom, marijuana/cannabis/hemp has tremendous value beyond its medicinal and industrial uses. While hempseed oil can be used for lamp fuel, printers ink, soap, shampoo, laundry detergent and wood preservation, it has been most valuable throughout history as a food for birds, fish, and humans.

Hempseed contains approximately 20-25% protein, 20-30% carbohydrates and 10-15% insoluble fiber, as well as a rich array of minerals including phosphorous, potassium, magnesium, sulfur, and calcium, along with modest amounts of iron and zinc. Most hempseed also contains polyunsaturated oil.

All this adds up to the most nutritious

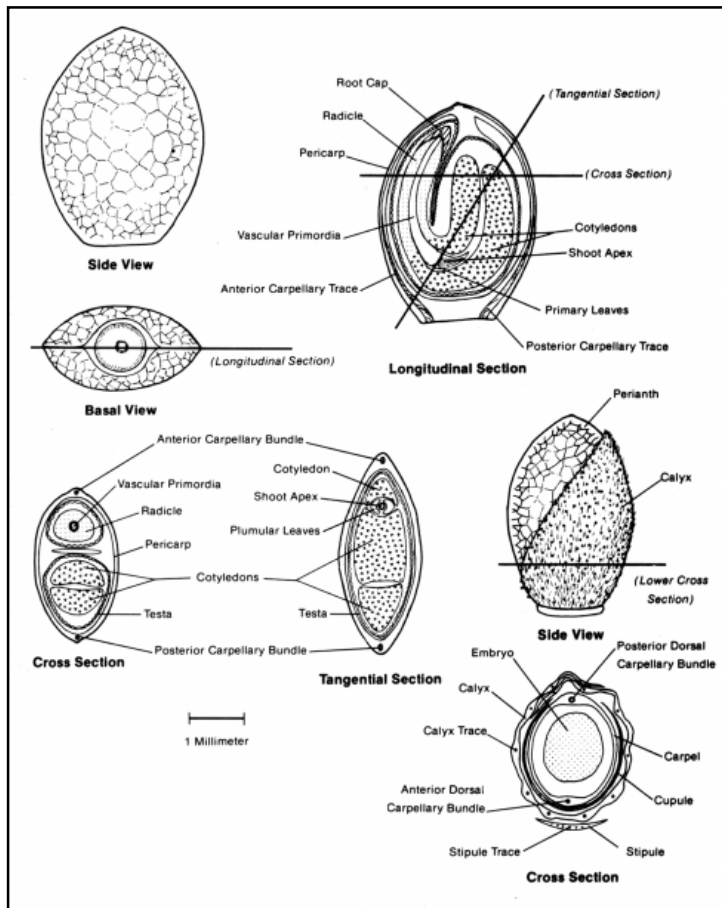

*Robert Connell Clarke's detailing of a hempseed from his excellent and highly recommended book Marijuana Botany. (If my book sparks questions, Rob Clarke's Marijuana Botany will have the answers.)*

*And out of the ground made  
the LORD God to grow  
every tree that is pleasant to the sight,  
and good for food;  
the tree of life  
also in the midst of the garden,  
and the tree of  
knowledge of good and evil.*

*And the LORD God  
commanded the man, saying,  
Of every tree of the garden thou  
mayest freely eat:  
But of the  
tree of the knowledge of good and evil,  
thou shalt not eat of it:  
for in the day that thou eatest thereof  
thou shalt surely die.*

**G**OD

*Genesis Chapter 2,  
Verses 9,16,17, and 22*

*Guess which plant I think is the Tree of Life?*

food resource ever found on Earth! Like no other plant resource, hempseed has both a high content of easily digestible, complete protein and a rich endowment of oil providing the most favorable ratio of Essential Fatty Acids (EFAs) required for proper human nutrition. In addition, hempseed provides a significant contribution of gamma-linolenic acid, which has potential therapeutic efficacy.

EFAs govern the life processes in our bodies. Life without them is impossible. EFAs are needed—but not produced—by the human body. We must get EFAs from external sources, the majority of which are of plant origin. Richer in EFAs than flax, evening primrose, or any other seed oil, hempseed oil is called “nature’s most perfectly balanced oil.” It is truly a nutritional wonder. At 81% polyunsaturated, hempseed oil is said to be the most unsaturated oil derived from the vegetable kingdom.

Hempseed oil’s unusually well-balanced profile means that you could use it for a lifetime and never suffer an EFA deficiency. EFA deficiencies have been linked to a variety of diseases such as cardiovas-

cular disease, cancer, diabetes, skin afflictions, multiple sclerosis, PMS, behavioral problems, poor wound healing, arthritis, glandular atrophy, weakened immune functions, and sterility.

Research and clinical trials show that EFAs have beneficial effects in people suffering from allergies, arthritis, PMS, asthma, diabetes, heart disease, inflammatory conditions, and cancer.

Anybody reading this book would benefit from the use of hempseed oil and food. A proper diet is essential to good health, and while medical marijuana may give you the munchies, it will not cure you of malnutrition. To get beyond disease we must build up our immune system by giving it proper nutrition.

My advice is to learn more about what you put into your body, eat more raw food, increase your fruit and vegetables, and add hempseed oil to your diet.

Two good sources of hempseed oil are from The Ohio Hempory, 1-800-BUY-HEMP and The Hempstead Company, 2060 Placentia, Costa Mesa, California, 92627, 800-284-HEMP.



## *Where To Get Medical Marijuana Seeds*

The quest for a continuous harvest begins with your first crop—by far your most important crop as well as your most vulnerable. Since your skills are also precarious at this stage, it is essential to follow my instructions carefully, particularly during the plant's delicate early development.

Until Home Depot starts selling medical marijuana cuttings, you'll have to grow your medicine the old-fashioned way, with seeds. This brings up two immediate problems:

- 1) How do I germinate my seeds?
- 2) How do I obtain them in the first place?

In a sane world, you could order from catalogues, selecting strains that were best for your condition. The Dutch, saner than most, actually have stores that legally sell seeds (as well as medical marijuana). So I strongly recommend a trip to Holland. Not only is it a beautiful country, but the friendly people are open-minded and their

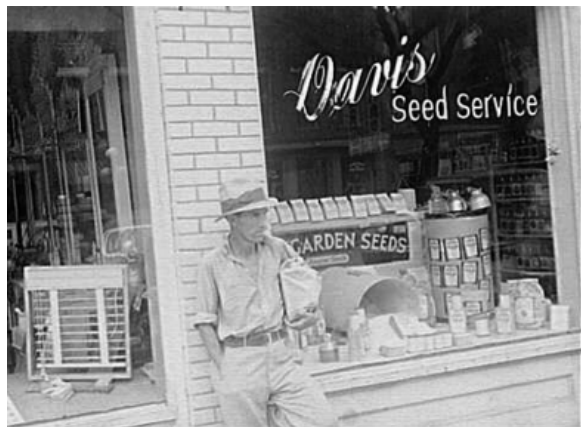

*Unfortunately, we can't just run down to the Davis Seed Service—as we could have done in 1936—and buy medical marijuana seeds.*



seeds are the highest quality found anywhere.

I also recommend the Sensi Seeds online catalog ([www.sensiseeds.com](http://www.sensiseeds.com)) for more information and plant references. (While they do not ship to America, most of their varieties have already made it to these shores and are being cultivated by people like you! If you know a sophisticated grower, you might be able to acquire a high-quality brand-name seed like a Northern Lights or a Jack Herer, which is named after the father of the modern hemp movement and author of *The Emperor Wears No Clothes*).

Of course, the U.S. government makes no distinction between recreational marijuana and medical marijuana and will arrest you if it catches you smuggling seeds into this country. Fortunately, seeds are tiny enough to be hidden practically anywhere, although I recommend not carrying them on your person when you fly back into America. Count on being searched coming back from Amsterdam. Let me tell you, it happens all the time

But some people told me they have



Page from the Sensi Seed Catalog. The two goblets are Cannabis Cups, awarded by High Times Magazine in Amsterdam each year to the best marijuana—sort of the Academy Award of pot.





*When hemp is planted for fiber, as this old woodcut illustrates, the seeds are thrown onto the ground with a broad sweep of the arm. This form of planting is known as “broadcasting.” The term we use for radio and television broadcasting came from this agricultural term, used most often for planting hemp.*

had good success mailing them back. When I worked at Positronics in Amsterdam, many customers would fill me in to their seed-smuggling secrets. I’ll pass some on to you:

1. Get a flat photo-mail envelope from any camera shop and a piece of corrugated cardboard a little thicker than the seeds. Cut out photo-sized squares from cardboard, then use a thin rod to push the tiny hemp-seeds down in between the corrugation. Cap off the corrugation with some toilet paper. Then place the cardboard—snugly housing all your future medicine trapped in a seed—into the photo envelope and mail it to yourself or to an alias at your home address (or better yet, a private postal box company, where you’ve opened an account with cash, right Mr. Smith?).

If you are doing this in Amsterdam be sure to wash your hands—fingers that have touched medical marijuana can contaminate the package and get it stopped. Usually photomailers are not searched. I have never heard of one not making it safely home to the good ol’ U.S. of A.

2. A variation of the mailer is to ob-



*A medical marijuana seedling. New life. The oval on top is the seed hull, worn as a protective covering for the delicate, still-maturing first leaves.*

tain these very small plastic vials (sometimes seeds sold in Holland already come in these). The vials are not much thicker than the seed and only about 8-to-15 seeds can fit into the vial. Take three pieces of cardboard the size of an envelope. In one of the pieces, cut out an area to fit a vial. Tape the vial in place and put the cardboard between the other pieces, insert in envelope, mail.

For safety's sake, divide your seeds among a few mailers to increase the chance that at least a few will make it home.

The upside of mailing is that you go through U.S. Customs anxiety-free without seeds in your possession.

If a visit to Holland isn't possible, you have to discreetly approach close friends and relatives you suspect having firsthand knowledge of marijuana and ask them for seeds. You'll probably be surprised how positive the responses will be. Genes matter, so try to acquire seeds from top-grade marijuana. Viability also matters, so make sure your seeds haven't been hiding in a sock drawer since the Nixon Administration.



(As mentioned before, you can avoid seeds altogether by acquiring medical marijuana clones through the same black-market scenario.)

How many seeds should you get? First you have to decide what your medicinal needs are (see Chapter Thirteen on Consuming) and how many plants you feel comfortable growing. The methods I'm teaching you will enable you to grow from a few to a few hundred plants at a time in the Sea of Green technique.

Let's say you decide to harvest only five plants this first time. How many seeds do you need? As many as possible. Danger lurks during every step of the growing process. Some seeds won't germinate. A few seedlings will die. Half the crop will be male plants and have to be destroyed. Starting out with five seeds or less would be flirting with disaster. Ten seeds is pushing your luck.

*CAUTION: The law says this is a fully grow marijuana plant, worth \$5,000, capable of producing 1,000 "marijuana cigarettes." When people say in astonishment, "You were caught with 4,000 plants the DEA says were worth 27 million dollars!" I pull out my babys' pictures and show them precisely what I was caught with.*

## ***Germination***

Store your seeds in a sealed container in the refrigerator until you're ready to begin. Then, handling the seeds as little as possible, drop them in a clear plastic cup



*The seed hull has split (half of the hull is below the leaves, like a cup; half faces the wall) and the first leaves emerge from their protective shell.*

or glass filled about halfway with room-temperature bottled water (tap water contains alkaline and other chemicals harmful to fragile sprouts).

Typically, bad seeds sink and good ones float, but there are exceptions, so don't eliminate any seed right away. Put the cupful of seeds in a dark closet. Soaking them will soften the hull and promote germination. Within three days, the hulls will crack and a tiny white root tip will emerge. When the tip grows to about a half-inch, it's ready to be planted.

### *Planting*

Let's say 10 seeds sprouted. At a garden shop or nursery, buy inexpensive Jiffy peat pods for each of them. The pods are the diameter of a silver dollar and only as thick as a matchbook, but they'll swell to the size of a marshmallow when you soak them in water for 10 minutes. Again, use bottled water. I know growers who think anything but Perrier is plant abuse during the entire growth cycle, but we'll be weaning ours off bottled water in a couple of weeks. To remove the sprouts from the





*The hull has dropped off and the first leaves reach toward the light. The miracle of life has, once again, begun.*

water simply drain over cheesecloth.

Use a tapered pencil-size object to make a one-inch-deep hole in the center of every Jiffy. Carefully—and I can't emphasize that word enough—remove one sprout at a time from the cloth with your fingers. Transplanting them into the pods must be accomplished without damaging the fragile tip or disturbing the hull. A damaged sprout will not have the vigor to grow into a healthy plant. Make sure not to pack the peat too tightly against the sprouts. Arrange the 10 pods inside a plastic tray.

If this all sounds like too delicate a procedure, just drop the seed into an half-inch-deep hole in the Jiffy pots, loosely cover, and treat like a seedling.

If you do not have access to Jiffys, you can use a small pot with straight, non-fertilized planting soil. Just fill the pot with soil and pack it down slightly. Poke a hole in the center with a pencil and plant one seed sprout (or seed) in each pot.

Now your seedlings are ready for the grow room.



*Me in my pre-DEA clone and seedling room. The shelves are, uh, off-the-shelf modular plastic shelving from a hardware store. The full-spectrum florescent lights hang above each tray of seedlings or clones. The white tags contain information such as the strain of medical marijuana and the date of the planting or cloning. I'm using a wand attached to a hose and a pump to water the babies—less rustic but much easier than a watering can. Note the terrific posture thanks to my first five vertebrae being fused together.*

## CHAPTER FOUR *The Grow Rooms*

In order to create a continuous supply of medicine, you need the ever-important Grow Rooms. But don't be intimidated by the word "rooms." You won't have to put an addition on your house to grow medical marijuana.

Grow Rooms can be practically any self-contained area or space. For a continuous harvest, you'll need three of these rooms because eventually you'll have three crop rotations going simultaneously, each in different stages of growth, each requir-





*Using a few pieces a scrap lumber, discarded windowframes, ordinary household tools (saw, hammer, ladder), a box of nails, one pound of Crazy Glue, and the plans in this book, you, too, can build—in just a few hours with no experience whatsoever—a greenhouse that will be the envy of your neighborhood.*



*In fact, you'll probably find building your first greenhouse so enjoyable, you'll start building a second one that very afternoon.*

ing different light cycles. The size of each space depends on the number of plants you grow. Since you have to start outgrowing from seeds, you will be limited initially by the number of seeds you acquire.

My idea of a perfect setup is an empty bedroom with two good closets, its own bathroom, and an entry door that locks (we'll talk more about security in Chapter Twelve). But since few of us have an empty bedroom that isn't filled with junk or reserved for Aunt Mary's visits, we have to improvise.

Although outdoor plants can reach 10-to-12 feet, your indoor plants will range from 3 or 4 feet-to-a few inches. All houses have several potential grow rooms cleverly disguised as closets. I know highly successful growers who grow the best medicine using nothing but closets, attics, basement cubby holes, metal garden sheds, second bathrooms, and kitchen cabinets. One of them shares his walk-in closet with his Mother Plant. What could be more creative—and ironic—than converting a dusty 1950s bomb shelter into a medical marijuana grow room?



*A modest-sized grow room. this should produce enough medical marijuana to keep one patient continuously supplied—providing the patient is not wasteful.*



*Here the Thomases, a family of five, grow enough medical marijuana for themselves—and a few sick neighbors, too.*

Although proximity provides convenience and security, the three Grow Rooms don't even have to be near one another, increasing your options. A friend uses an upstairs linen closet and two 4x4x4 metal sheds in the garage—and still has room for the car.

If you're willing to do a little construction, it's even possible to build two of the grow rooms in one ordinary closet. Hang a small lamp (lighting information starts on page 143) for a Mother Plant, then build a shelf 1½ feet off the floor in the same closet. Install fluorescent lamps under the shelf for your clones. This setup would be ideal for someone with limited space. The mother would sit on the shelf. You could take cuttings from her, then slide the clones directly under the shelf for rooting.

In choosing your rooms, don't eliminate a space just because it doesn't have electricity and ventilation. Extension cords, while ruining the ambience, are a grower's best friend, enabling you to run all your lights as well as the cheap little fans that can ventilate the smallest of spaces.

## *Supplies and Equipment*

Before I get into what actually grows in each of the three rooms, I want to talk about cost. To get started, even with only a few plants, and to do it right, you'll have to invest about \$700 (without seeds), about the cost of two ounces of medical grade marijuana in California.

About a third of your purchase will go for a high-intensity lamp used in the flowering stage. While it may be possible to grow indoors for less money just using fluorescent lighting, the difference in the quality and quantity of the medicine is not worth it. Computed over a period of years, the costs are negligible. And aside from replacing bulbs every several crops, your future expenses will be limited to electricity, fertilizer, cloning supplies and upgrades.

Most of your equipment can be purchased at any decent garden center, but you'll probably have to buy your flowering light at a specialty shop or mail-order house. Ads for lighting equipment can be found on the Internet and in *High Times*



*A basic thermostat (left) to control the temperature. A thermometer and humidistat (right) indicate the temperature is 80 degrees Fahrenheit and the humidity is 58 percent. As you can probably tell from the design, these are two separate units. More expensive models measure and control everything all in one unit.*

magazine. You can also consult your local Yellow Pages under Lighting or Gardening.

There are three major types of lighting systems available: incandescent, fluorescent, and high-intensity discharge (HID).

### *Incandescent*

Incandescent lights are horribly inefficient (especially the screw-in “grow bulb” type) and really not an acceptable option for plant growth. Although they are inexpensive to purchase, their cost of operation makes them the costliest source of light.

### *Fluorescent*

These tubes have tremendous advantages over incandescents. They emit about three times as much light as an incandescent (given the same wattage), and the light spectrum is one that plants can use more effectively.

However, they do have their limitations. Light is emitted over a large area, so it is not concentrated. Because of this, the lights have to be hung very close to the plants (usually within 2 inches or so from



*Fluorescent lights burn cool and can be placed almost anywhere.*

the growth tips). Their light intensity is low and don't produce great buds at flowering.

Florescents are, however, very useful in cloning and starting seedlings. They also put out a more gentle light than the HID lamps and release far less heat. The fact that they produce less heat is very important to those growing in enclosed and not-especially-well-ventilated spaces. If you can afford no heat build-up at all, however, florescents are the way to go.

When using florescents, it is best to purchase the 40-watt "cool white" variety. The ones that are sold as grow lamps (including Grow-Lux, Vitalite, etc.) are not much more efficient than a standard fluorescent and sometimes 10 times the purchase price. The slightly different spectrum produced by these lamps does little good for most plants. I have used both types side by side with the same plant genetics and saw little difference in growth. I, however, enjoy the light emitted from the grow lamps better than that of standard florescents.

### ***High-Intensity Discharge (HID)***

High-intensity discharge lamps are easier to use and more efficient. Low-watt-

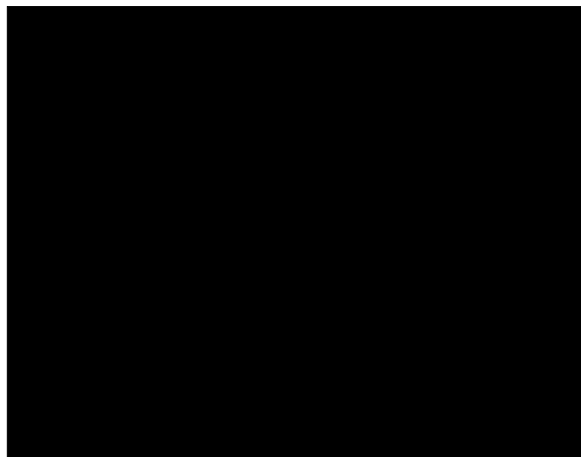

*Light, off.*

age HID's are sometimes sold for household outdoor use. Large wattage lamps, they are used for lighting streets, parking lots, stadiums and other large areas. They come in two basic types: metal halide and high-pressure sodium.

### ***Metal Halides (or MH lamps)***

These emit a white light that looks slightly bluish. They are used to light stadiums, convention centers, gymnasiums and other large areas where a natural-looking light is desired. Some growers swear by metal halides in the Mother Room for vegetative cycles but use high-pressure sodium for flowering.

### ***High Pressure Sodium (or HPS lamps)***

These emit a pink or amber light. They are used for lighting parking lots and other areas where the color of the light is not important. HPS units are much more efficient than MH, producing more light and less heat per watt of energy consumed. They are often used alone with no detrimental effect on the plants, and will promote faster plant growth than MH lamps

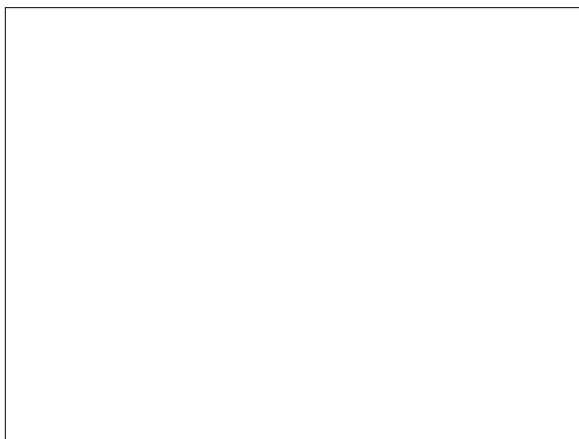

*Light, on.*



during both vegetative growth and flowering. Combinations of bulbs are not required, as the HPS lamp does produce all of the light spectrum necessary for healthy growth.

There is a relatively new type of HPS lamp called the San Agro lamp. These lamps are the best for growing. They contain an element that puts out blue light to help fill in the parts of the spectrum absent in standard HPS and MH.

MH lamps are available in 175-, 200- 400- and 1000-watt sizes. HPS lamps come in 50-, 75-, 150-, 400- and 1000-watt sizes. San Agro comes in 430w and 600w. Each lamp requires its own ballast, which comes with the fixtures but is also available separately.

Gardens should receive 1,000-3,000 lumens per square foot. Successful gardens usually are lit at around 2,000 lumens per square foot. During the vegetative stage, plants stretch out when they receive low levels of light. During flowering in inadequate light, the flower clusters are loose and sparse.

So what is the best lamp for growing?

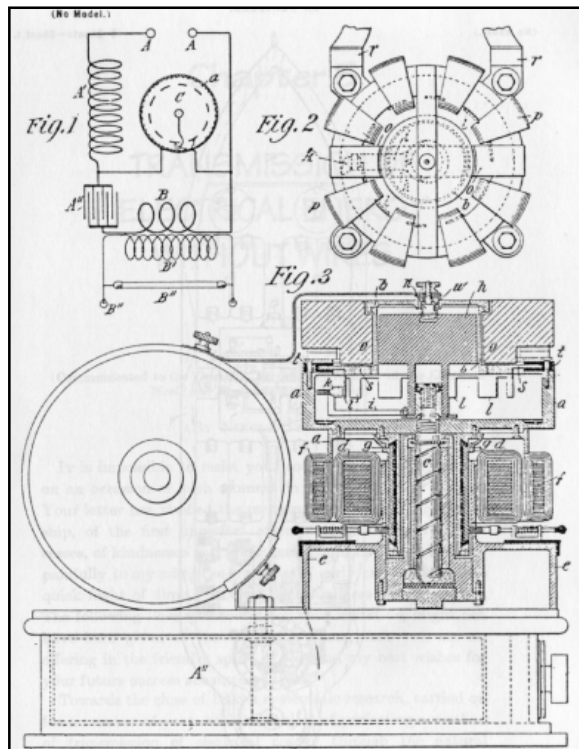

Use this simple chart to select and install your lights.

It depends on your budget. I think the 600w HPS San Agro lamps are by far the best overall choice. They have twice the amount of light intensity as a 400w lamp for only 200 more watts of electricity. They have been used in Europe for some time but only made it over to America in 1997. They may be more expensive to purchase at first, but they are the cheapest to operate, and the utility savings does eventually add up.

Before purchasing a lamp, be sure to read Chapter Twelve on security.

Here's a list of the basic supplies and equipment to get your continuous harvest going (we'll go over each in detail later in this and other chapters).

You don't have to build all the rooms at once. In fact, you have a month or so after building your first room to finish the next two.

While reading the list, don't be concerned about what these items actually do, nor be intimidated by words like "pH meter." You'll learn the system gradually, but I assure you, taken one step at a time, the growing process is easy and enjoyable.

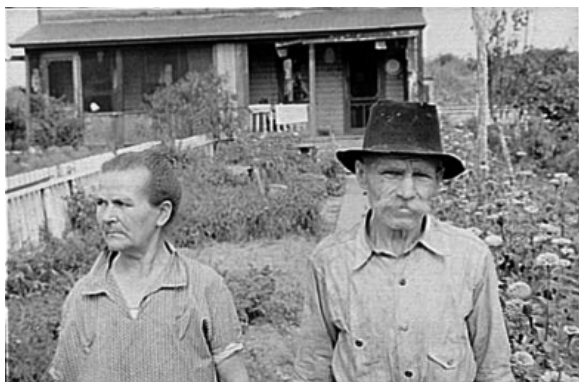

*Having built a state-of-the-art clone room, mother room, and flower room, Carol and Jim O'Conner ponder most sincerely how best to equip their House of Medicine, as they like to call it.*



*The correct choice of timer is very important to the Sea of Green technique.*

### *Supply List*

- 1 600-watt HPS+ system—\$300 (for flowering)
- 1 200--to-250-watt MH lamp and ballast—\$85 (for mother plants)
- 2 4-foot double florescent light fixtures — \$30
- 4 4-foot standard florescent bulbs — \$12 1-foot by 2-foot plastic trays, no holes — \$10 (for cloning)
- Various fertilizers - \$20 (I use Organic bat guano 20-5-5 (N-P-K) for mother plants and seabird guano 5-20-20 for flowering.)
- 10 4-inch plastic pots (square ones are best) for vegetative growth
- 5 2 gallon pots for mother plants
- 10 2 gallon plastic pots for flowering and vegetative growth
- 3 one foot oscillating fans—\$45
- 2 large bags potting soil (I use Supersoil®)—\$20.
- 1 large bags each of vermiculite and perlite—\$15
- Cloning supplies—\$50-\$75 Clonex® root gel Rock wool 1"x1" slabs of 100 cubes Pruning scissors
- Peat pods—\$2-\$5. (for seedlings)
- 2 electrical timers—\$10 (for mother and flower rooms)
- 1 moisture meter—\$12
- 1 pH meter—\$12-\$30
- 1 bottle each of pH Up and Down solutions—\$10.
- 2 plastic spray bottles—\$8.
- Garden thermometer (temperature and humidity)—\$15-\$35

### *The Three Rooms*

Whatever space you select, you'll have to do prep work. The rooms should be as clean as possible and free from insects and other pests. The walls should be painted flat white to reflect light. If you care about the floors, cover them with a sheet of thick plastic. If your space doesn't have a door, hang a curtain. All the rooms should be extremely lightproof.

Their names are Clone, Flower, and Mother.

### *Clone Room*

These lamps will be on 24 hours a day. Your plants will go through the rooting and vegetative stage here. Select an area like a sliding-door closet or empty shelf in your basement. Hang two of the doublewide fluorescents about 12-to-18 inches clearance.

Install a fan to vent the room without wind hitting the clones directly.

If you put the plants on the floor, you may have problems if the floor is cold—the roots may not develop as well as nor-



*Clone room.*



*Growing underground has its advantages—it's cooler, darker, and less likely to be stumbled upon by accident.*

mal. A remedy would be to elevate the plants off the floor by putting them on a platform. Or, buy a root warmer, available at most grow shops.

### ***Mother Room***

This lamp will be on 18-24 hours a day to nurture your clone-giving mother plant, or plants. Since only one or maybe just a few plants at most will reside in this room, a small space will do. Hang the MH lamp here.

### ***Flower Room***

When their vegetative stage ends, your plants will be transferred here to grow the dense flowers that will become your medicine in 45-to-60 days (or sometimes longer, depending on the variety). To get the plants to produce optimum amounts of medicine, your light source has to have plenty of kick, so this is where you hang the 600-watt HPS+.

Since these lamps produce a great deal of heat, you'll also need good ventilation.

### ***Ventilation***

Ventilation is essential in each of the

rooms. You can probably get away with just a fan as long as the temperature doesn't get too hot, meaning 85-to-90 or above, but you'll have to vent the room once a day at least. I also recommend a system that can both bring in fresh, filtered air (no bugs) and exhaust hot, stale air. You can rig a cheap efficient system using a small blower fan connected to clothes-dryer venting tubes, the intake capped with an air-conditioner filter.

In the Flower Room, it is especially important to get fresh air exchange.

If the distinctive aroma of your flowering plants might arouse suspicion, get a negative ion generator and place it in your flowering room near your exhaust fan. Negative ion generators are widely available, sold as air purifiers. Grow equipment supply companies carry them, as do most hardware stores. Say you have to get rid of skunk smell—you'll be telling the truth.

### *Fans*

The gentle wind from the fan should blow horizontally across the tops of the plants. A 6- to-12-inch oscillating fan will be adequate.



*Some fans are cooler than others.*



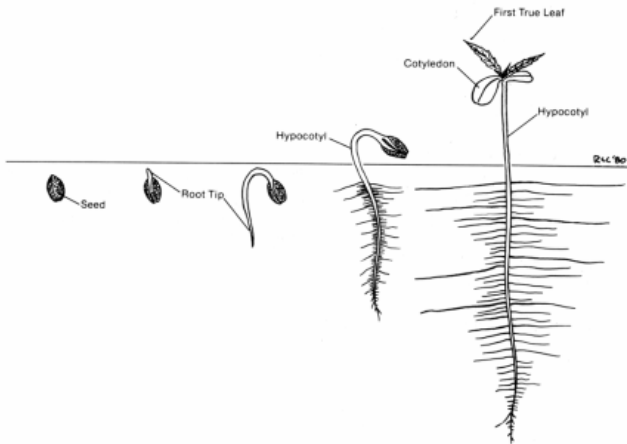

*The stages of a seedling drawn by Robert Connell Clarke from his Marijuana Botany.*

## CHAPTER FIVE

### *The Vegetative Stage*

When last seen, your 10 sprouts were in Jiffy pods on a plastic tray. Now set the tray in the Clone Room under the florescents, as close as an inch, no farther than six inches away. Use tags to number and date the pods. Little plastic white tags work great with magic marker and can be cleaned off with nail-polish remover and reused.

If all goes well from now to flowering, harvesting and curing, it will take another 11-to-16 weeks or so before you smoke the first bowl of your homegrown medical marijuana.

Keep the lights on 24 hours a day. The newly hatched seeds need the long daylight. Keep the pods moist to wet and make very sure not to let them dry out. The fan shouldn't blow directly on the pods. The hull contains so much nutrition that the teenie seedlings will not require fertilizer for a while.

Within a week, the first leaves will appear and numerous threadlike roots will begin emerging from bottom of the pods. When the roots begin wrapping around the sides, the plants are ready to be transplanted into the 4-inch pots.

### *Transplanting*

Mix the potting soil (60%), perlite (20%) and vermiculite (20%) and a recommended amount (as directed on the box) of bat guano (or equivalent fertilizer). Make enough to fill the 4-inch containers—one per pod—within an inch of the top. Scoop out enough dirt in each container for a single pod. Without touching the roots, place the pod in the soil and gently level the surface. Then give the soil a gentle soaking with plain water (see below for watering tips).



*Seedlings successfully transplanted into 4-inch pots.*

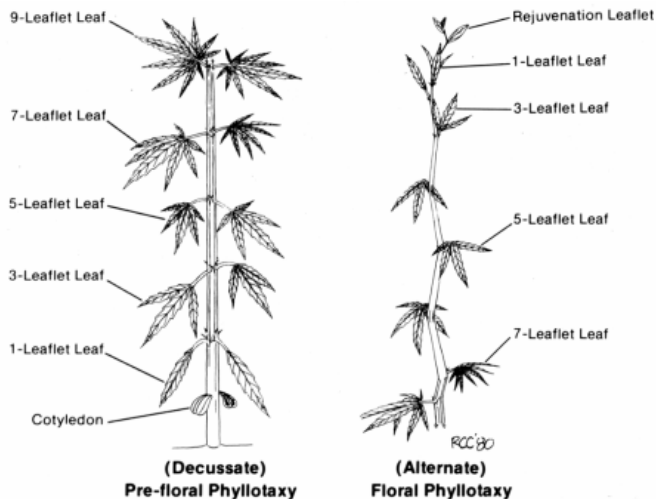

*Robert Connell Clarke shows us how leaves develop as the mother plant grows taller.*

Set the pots onto a tray. You should be able to fit 10 4-inch square pots on each tray. Place the tray back into the Clone Room under the florescents, which should be raised to just inches above the plants and continue to be on 24 hours a day. Keep the soil moist but not wet.

After one to two weeks in the 4-inch pots, the plants will develop a good root ball. Then transplant them into the 2-gallon pots and set them into the Mother Room under the 200- or 250w MH lamp, on 18 hours. (Since you don't have a Mother Plant yet, we're using this room now to take advantage of the big lamp.)

### ***The Health Of Your Seedlings***

The nice thing about starting with only a few plants is that they're easy to care for and take little time. By observing them daily, you'll know quickly whether any of them are not doing well. A healthy two-week-old seedling will sit up proudly, leaves dark green and lustrous, stem tough and sturdy. Height is not initially as important as fullness and vigor. A tall spindly plant with droopy leaves is not a happy camper.



*One of the great fertilizer producers in American History, William J. Bennett—our first Drug Czar and still at it. In 1987, he personally blocked needle-exchange programs with his fertilizer. Today, 200,000 more Americans—many of them women and unborn children—have AIDS thanks to Bennett. In 1996, he personally spread his fertilizer throughout the Arizona legislature, causing them to pass legalization nullifying Arizona’s Proposition 200, the medical marijuana initiative. If we could only harness Bennett’s fertilizer, we could grow enough medical marijuana to medicate the world.*

Sometimes, despite your best efforts, a young plant is going to wilt and die. Call it fate, bad luck, or a defective gene.

Sometimes, despite your neglect, a sickly plant will come back to life. Call it luck.

### ***Fertilizing and Watering***

While you can’t fight fate, you can do something about your luck. Two crucial components in the growing process are water and fertilizer.

As promised earlier, once you get your seedlings into the Clone Room you can replace bottled water with regular tap water, as long as you aren’t using a home water-purifying system. These systems reduce or remove the chlorine from the water. While this is good for you, chlorine is a necessary chemical to a plant. Most fertilizer providers remove any significant quantities of chlorine, thinking it will be supplied in the water (check with your water supplier for information on chlorine).

It is important to test the pH level in the water. While seedlings like a pH of 6.2, your maturing plants thrive at 6.8-to-7.0.

Much higher or much lower pH levels inhibit the plants' ability to absorb fertilizer.

An electronic pH tester is cheap and worth the money. It is much more accurate and easier to use than chemical testing kits.

Use some of your pH Up or pH Down to adjust pH levels. Add the relevant chemical a little (very little) at a time to your water. I suggest checking pH every time you water. After adding fertilizer to the water, you must check the pH.

After transplanting your plants into the 2-gallon pots, it's critical to water thoroughly and then allow the root ball to dry out completely, down to the very bottom of the container, before watering again. I repeat, do not over-water. This is the most common mistake indoor gardeners make whether they're growing medical marijuana or begonias. Fortunately, modern technology has come to our rescue with the Moisture Meter. Think of it as insurance for 12 bucks.

You simply poke the tip of your Moisture Meter down deep into the root ball, and if the arrow points to "dry," you water. Easy as that. Of course, there are other ways



*Despite the positive appraisal  
of the therapeutic potential  
of cannabinoids ...,  
they have not been widely used. ... Part  
of the reason for this is that research  
on the therapeutic use of these  
compounds has become  
a casualty of the debate  
in the United States  
about the legal status of cannabis. ...  
As a community we do not allow this  
type of thinking to deny  
the use of opiates for analgesia.  
Nor should it be used to deny access to  
any therapeutic uses  
of cannabinoid derivatives  
that may be revealed  
by pharmacological research.*

AUSTRALIAN NATIONAL  
TASK FORCE ON CANNABIS  
*The Health and Psychological  
Consequences of Cannabis Use*  
1997

to test for dryness, including the old toothpick method, but I guarantee they're not as exact as the Moisture Meter, and your plants could die if their roots begin to rot.

With a meter, you don't have to be afraid of letting your plants get bone dry. You'll also find that they may set their own individual watering schedules. Don't deny them. Pamper your plants. Indulge them and they will reward you. Moisture testing takes only minutes a day, a good investment to ensure optimum growth.

### ***Temperature And Humidity***

Rule of thumb: 68-to-80 degrees is the average acceptable temperature. Since temperature is hard to control in summer and/or in hot climates without proper air intake and exhaust, heat will probably become your biggest problem.

If you can't keep the temperature of your rooms below 95 degrees with ventilation, air conditioning, or muttering the incantation, "cool, cool, cool," you'll have to go fluorescent.





## CHAPTER SIX

### *Sexing and Cloning Your Plants*

The title of this chapter alone is enough to get this book banned in many places. “Mildred, have you seen what these drug addicts are doing to plants? We know sex is wrong and cloning is wrong, so this must be very wrong. And with plants!”

Since there is no way to discern the sex of a plant by looking at the seed, you will have to go bravely forth and learn the important concept of sexing. (There, there. We were all nervous our first time.)

## Sexing

Sexing merely means discovering a plant's sex. Medicinal flowers grow only on the female plant. Males are unwanted not only for their unusable flowers, but because they will pollinate the females, something you want to avoid at all costs. A female flower with seeds is not nearly as desirable as a seedless female, called *sin-semilla*.

Growers who start off with seeds have to go through the sexing process only once, because from then on you'll be growing only females.

Your first step toward this knowledge is getting familiar with the growth tip.

When a plant is young, the growth tip is the very apex of the stalk, or stem. As side branches develop, growth tips sprout from their ends as well. Eventually, each growth tip becomes a flower. The biggest flower is always at the top of the plant on the main stem. The more vibrant and healthy your plants are, the fatter the growth tips, the bigger the flowers, the more potent the medicine.

A medical marijuana flower neither

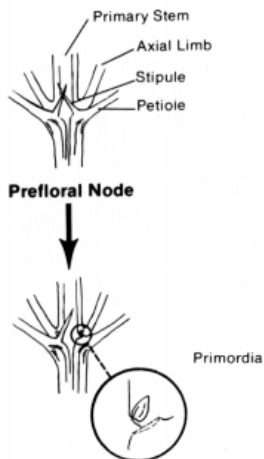

Robert Connell Clark  
on how to tell male from  
female early enough to  
do something about it.

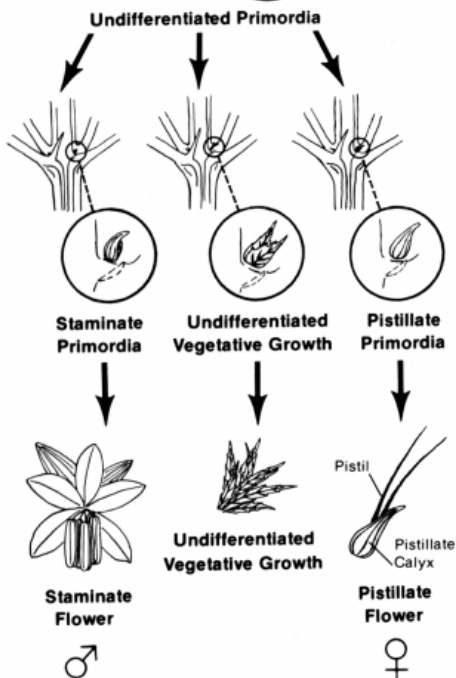

bursts with color like a tulip nor drops to the ground like a rose petal. It grows from the end of every branch, leafy green buds tipped with small white tufts of hairlike pistils. When you learn to recognize growth tips, you can sex and clone your plants.

To sex a plant, you need to take one clone from each plant. That means we must learn how to clone. We'll get back to sexing in a moment. Let's focus on cloning. Cloning is a technique you will use often in the Sea of Green Technique.



*In more enlightened times, we would be able to use the male plants in floral arrangements. This, however, is not a recommended centerpiece in suburbia—the kids these days know so much!*

## ***Cloning***

### ***Supplies:***

Small jar of Clonex rooting gel

Tray of 1-inch-by-1-inch rockwool rooting cubes. You will need one cube per clone. (Rockwool is rocks, melted, and spun fine like cotton candy. Honest. It holds just the right amount of moisture and also provides necessary support for the clone.)

Sharp scissors.

Exacto knife or razor blade.

Plastic cups.

Plastic labels.

Waterproof marking pen.



*1. Set up a sterile working area. Clean all surfaces and utensils with rubbing alcohol. Before use, soak the rock-wool cubes in water to remove any dry spots. The water pH level should be 5.5-to-5.7.*



*3. Select a growth tip. You'll see a set of leaves at the end of the growth tip, a second set of leaves about two inches below that, and a third set of leaves about two inches below that. Cut just above the third set of leaves at a 45-degree angle. Congratulate the Mother Plant on her newest offspring and an easy birth.*

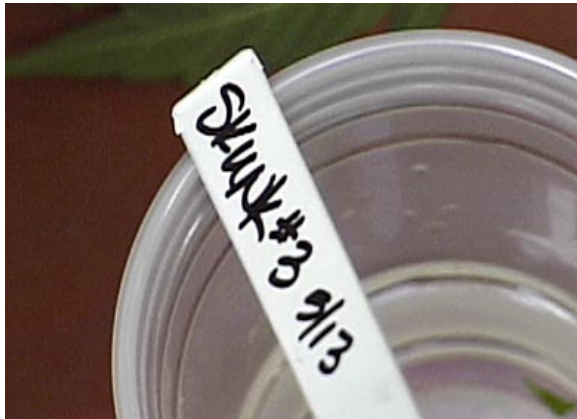

*2. Fill a plastic cup one-third full of bottled water. On a plastic label, write the name of the mother plant (in this case it's "Skunk #3") and the date. This set of clones was cut on May 3, 1997 and destroyed by the DEA on July 29, 1997. Rest in peace.*



*4. Trim off the second (lower) set of leaves only.*





5. Trim off the tops (about an inch) of the remaining leaves.



6. Place the cutting into the cup. The idea is to go through steps 3, 4, and 5 as quickly as possible and get the cutting into the cup as soon as possible. After you get the hang of it, from cut to cup should take less than a minute. One cup will hold five-to-ten clones, but keep clones from different mothers in different cups.



7. After you've gathered your clones, take them to the already prepared sterile work area. Once you start cutting, you want to get the clones into their rooting material as soon as possible. Now's not the time for a TV break.



8. Using a razor blade or, preferably, a Exacto knife, trim off the outside layer from the bottom one-half inch of the cutting. This is like peeling a carrot: leave most of the stem behind, removing only the thin outer covering.



**9.** Dip the end of the cutting into the Clonex solution, covering fully the area just peeled clean. (I use the Clonex cap for this so I can pour the unused solution back in the bottle.)



**10.** Carefully place the tip of the clone about an inch into the hole of a rockwool cube. Stick the label from the cup into the far edge of the same cube. Each cutting is labeled with the name of the mother and the date cut. (Later, when you're cloning from one or two mothers, you'll need less labels.) That's it. You have cloned.



Move tray to Clone Room. Keep an empty rockwool cube in the tray to test wetness. Rule of thumb: don't add water if you can squeeze a drop of water out of the cube. The cubes will require water about every one-to-three days. Just pour directly into the tray. The rockwool will retain just the right amount of water for the clones. These will root in a couple weeks and be ready for transplanting. Okay, now you can take a TV break.



### *Back to Sex*

After a couple weeks the clones you placed under 24-hour-a-day light root as described in Chapter Nine, *Cloning for a Continual Harvest*.

To sex, after roots develop you can then transplant the clones into a 4"X4" pot. When a medical marijuana plant flowers, it reveals its sex. to do this adjust the timer in your Clone Room (that is if you don't have other clones rooting, if you do have other plants rooting you will have to put them into another room) for 12 hours on and 12 hours off. This triggers the plant's internal clock to say, "Twelve hours of darkness means winter's coming on. Enough veging around. Time to reproduce."

During the off period, the Clone Room (or whatever room your using) must remain in absolute darkness. If even a little light gets in for a few seconds, the plants will think it's Spring again and stop flowering. This absolute-darkness rule applies to all flowering cycles.

In about two weeks, the males will begin to display their maleness. Look for

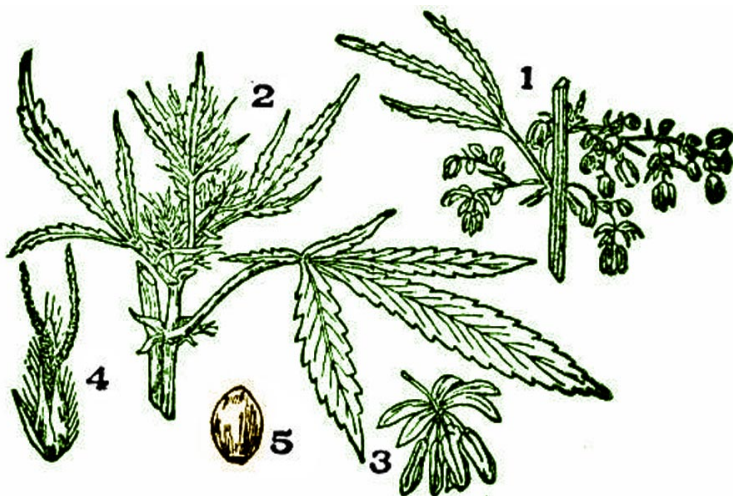

(1) Male flowering plant, (2) female flowering plant, (3) male flowers, (4) female flower, (5) seed (which actually is a small nut, like me).

pollen pods, specks the size of a sesame seed in the crotch of a branch. Destroy all male clones and the plants they were cloned from. About half the plants will be males

## ***The Mother Plant***

You have an important choice to make. You must select one of your plants to stay perpetually in the vegetative stage under 24-hour-a-day lights in the Mother Room. This plant will be the Mother of All Future Plants, progenitor for your continuous harvest. Pick the healthiest plant, which should produce a perpetual litter of equally vibrant offspring.

The Mother Plant (or plants, if you want to play it safe) sits 18 inches below the Mother Room lamp. (If you're forced to use florescents, place them within 3 inches of the plant.)

Water on a normal basis with the water at a pH of 6.8-to-7.1 . Your Mother will fill out and you will not want her to grow higher than 3 or 4 feet. This can be best accomplished by cloning from the top and pruning (For details on pruning, see Chapter Eleven).



*Some mothers sunning themselves on the patio of Liberty Castle. It takes a mother to make a house a home.*

***The Flower Room***

The rest of the mothers can be transplanted into larger pots, as described in Chapter Five, and put under the 600-watt HPS lamp in the Flower Room. The light cycle is 12 hours, 12 hours off. I recommended off-peak times, such as 6:00 PM-to-6:00 AM. Electricity meter readers come by during the day, and a rapidly spinning meter might arouse suspicion. It's also cooler at night, all the better to keep the lights from overheating your Flower Room.

Again, and this cannot be stressed too strongly, the Flower Room must be kept absolutely dark at all times during the off cycle. Some people put combination locks on their flower rooms—not to keep out intruders, but to act as an extra reminder, “If it's during the dark cycle, don't open this door.”

Make a note of the date. Harvest is now 45-to-60 days away, depending on the strain of medical marijuana you have chosen. (Some strains take as long as 115 days to flower.) Make note of how long the plants take to fully mature. This will help you time future harvests.

*ED NOTE: At this point in the life cycle of medical marijuana plants, the DEA came in and hacked to death all of Todd's mother plants and destroyed his thousands of cuttings. The photographs of flowering plants that should have graced these pages for the remainder of this book were never made, due to DEA's destruction of Todd's research and photographic subjects. We will, instead, use quotes selected to bring about enough freedom to let an author and researcher grow plants in his own home and research facility. Here's to the day this book can be properly published.*

## CHAPTER SEVEN

### *Flowering*

Your plants will be in the Flower Room for about two months, unless they're one of the early finishing varieties or one of the later (longer) finishers. The secret to producing top-quality flowers is to continue observing your plants carefully and following my instructions to the letter.

Make sure the plants stay at least 18 inches from the light, unless you're forced to use florescent light to flower, in which

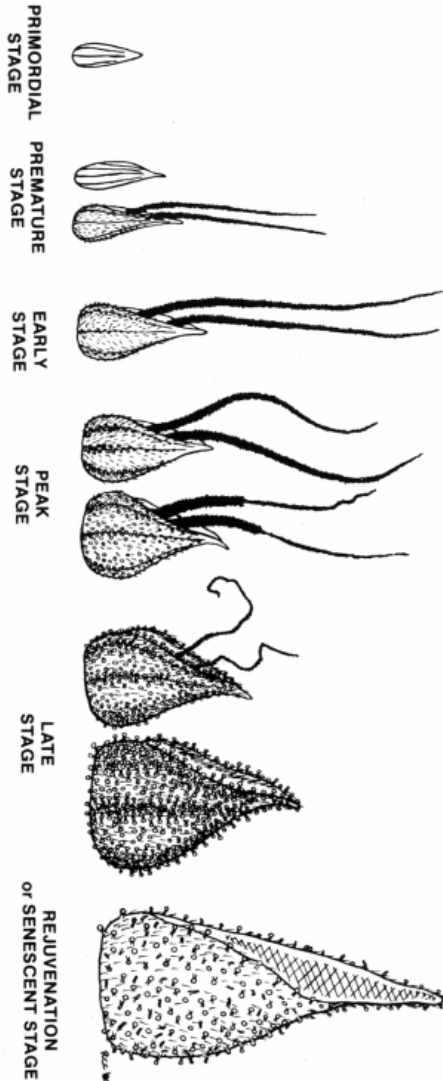

*Robert Connell Clarke illustrates the stages of a medical marijuana flower.*

*God said,  
“Behold, I have given you  
every herb bearing seed  
which is upon  
the face of all the earth...  
to you it will be for meat...”*

*And God saw everything  
that he had made,  
and behold,  
it was very good.*

GENESIS 1:29-31

case they should be an inch or two from the growing tops..

Within two weeks, you'll begin to see the first delicate flowers emerge, those whispery pistils. It's at this time I recommend giving your plants a good once-over to make sure they're all truly female. Sometimes under stress, females can become hermaphrodites, meaning both sexes. In that case, you'll see both pistils and pollen pods.

If this occurs, you must destroy the plant. Don't replicate my mistake by trying to pick off the pods. They're too easy to miss. I once thought I'd nabbed all the little buggers but I didn't, resulting in the pollination of two or three neighboring females, practically ruining the harvest.

As the weeks go by, the flowers will swell with medicinal resin and give off a delightfully sweet, pungent fragrance. Watching them develop always gives me a sense of accomplishment and pride. Like kids, they grow up fast. Overnight, flower buds pop up at the ends of branches. All along the main tip, flowers gradually grow into one long cluster entwined with stubby green leaves. This is called the main cola.

*In the latter times,  
some shall...  
speak lies in hypocrisy...  
commanding to abstain from  
meats which God hath created  
to be received with thanksgiving  
of them which believe  
and know the truth.”*

**ST. PAUL**  
*1 Timothy 1-4*

Examine the graceful fingerlike hairs of the pistils under a magnifying glass. You'll see hundreds of glistening crystal globules the size of a pinprick. These contain resins you most desire.

Your goal is to time your harvest to ensure optimum resin levels. The easiest way to track the aging of your plant is to observe the pistils and the resin. Pistils start off white and begin turning reddish brown or orange late into flowering. Resin goes from clear to amber.

I suggest you experiment. When some of the pistils begin turning a reddish or orange brown, cut down one of the plants for an early harvest. When half the pistils have turned, harvest another plant. And when all the pistils have died in the rest of the plants, harvest them. Label each harvest and compare their effects.



*“The lord said...  
“Afore harvest,  
when the bud is perfect...  
he shall cut off the sprigs  
with pruning hooks  
and take away and cut down  
the branches.”*

ISAIAH 18:4

## CHAPTER EIGHT

### *Harvesting and Curing*

Harvesting is a joyous time, but if you're like me, you'll also feel a tad guilty for cutting down these magnificent plants. In ancient times, celebrations accompanied the harvest and prayers were said to thank the gods for creating the most versatile plant on the planet. While you'll just use it for medicine, your ancestors would also have converted the fibrous stalk into innumerable necessities like fuel, durable clothing, and long-lasting writing paper.

*There are only two ways  
to live your life.  
One is as though  
nothing is a miracle.  
The other is as though  
everything is a miracle.*

ALBERT EINSTEIN

Cut down your plants at the base of the stalk. Remove all extraneous leaves from the branches so that only the flowers remain. All those big leaves and pointy leaf tips protruding from the long main cola? Trim those off.

When you're finished trimming, hang the plants upside down in a room with lowlight or darkness. Humidity should be 40-60%, but fungi and bacteria thrive in this environment, so make sure to disinfect the area first (spraying rubbing alcohol works well) and maintain adequate ventilation.

The longer the cure, the smoother the taste. Depending on how well you control humidity, it will take 3-to-15 days before the flowers are dried out and ready to be smoked. In the meantime, put a few flowers in your oven overnight with just the pilot light on or in a crockpot set on high. By morning, they should be ready to sample. Because you used a fast-curing process, the smoke may be harsh. (If you've never smoked medical marijuana, please read Chapter Thirteen before trying any.)

After the flowers are cured, gently snip

off the dead branches and seal the flowers in a baggie or, best yet, a vacuum-sealed jar.

Before you throw away the bare branches (see Chapter Twelve on security), first try to rip the main stalk in half with your hands. I think you'll learn exactly why hemp is called the world's strongest natural fiber.

*Doctors are not the enemy  
in the "war" on drugs;  
ignorance and hypocrisy are.  
Research should go on,  
and while it does,  
marijuana should be available  
to all patients who need it  
to help them undergo treatment for  
life-threatening illnesses.*

*There is certainly sufficient evidence to  
reclassify marijuana  
as a Schedule II drug.*

*... As long as therapy is safe and  
has not been proven ineffective,  
seriously ill patients  
(and their physicians)  
should have access  
to whatever they need  
to fight for their lives.*

THE NEW ENGLAND  
JOURNAL OF MEDICINE,  
August 7, 1997

*On either side of the river,  
was there the tree of life,  
which bare 12 manner of fruits,  
and yielding her fruit every month;  
and the leaves of the tree  
were for the healing of the nations.”*

**REVELATIONS 22:1-2**

## CHAPTER NINE

### ***Cloning For a Continuous Harvest***

Up until now, your main focus has been raising plants from seeds and setting the stage for a continual harvest. You've been taught to sex your plants and juggle your grow rooms and you've learned all the basics of cloning. You are now ready to put it all together to supply your medical

*He who hesitates  
is a damned fool.*

M<sub>AE</sub> W<sub>EST</sub>

marijuana needs for years to come.

Here's how a continual harvest works: Take clones from the Mother Plant, raise them in the Clone Room for a month and ripen them into medicine in the Flower Room for two more months while the Mother Plant keeps churning out babies, *ad infinitum*.

Which brings you to a crossroads: how many plants do you feel comfortable growing at once? With this three-room method of gardening you can manage from a few to a few thousand plants. But that's your choice.

Here's how you start your second crop and trigger the continuous harvest: A month before your first harvest is ready, clone Mother. Mother by now has been sprouting new growth tips for the last 30 days and may have a few dozen ready for cloning. Select healthy, well-developed growth tips from the upper branches. Follow cloning directions detailed in Chapter Six on Sexing.

Clones are not able to absorb nutrition until they have roots in 7-to-10 days. Mix water-soluble fertilizer with 5.5-to-5.9

*People demand  
freedom of speech  
to make up for  
the freedom of thought  
which they avoid.*

KIERKEGAARD

pH water. Use a spraybottle to spritz the clones' leaves at least once a day. As soon as roots emerge, remove the plastic from the cubes and transplant them into 2-gallon containers filled with the usual soil mix (see Chapter Four). Keep the lights on 24 hours and make sure the soil remains moist until the roots become established.

A month from the time they were taken from Mother, the clones will be about a foot tall. Even though they aren't nearly big as your first crop was when it was forced into flowering, put them into the Flower Room (with your first crop about halfway done) under the 600-watt HPS on 12 hours a day and fertilize with the sea-bird guano 5-20-20.

At the same time, make a new set of clones. In a month when they've rooted and been transplanted into soil, they'll join the first batch of clones in the Flower Room and you'll make new clones. This means that every month from now on you'll be rotating a new crop of clones into the Flower Room and harvesting a crop.

I told you it would be easy.



*The fact that THC  
has naturally occurring analogs  
in the human body  
flies in the face of  
Reefer Madness propaganda.*

*A natural compound  
with specific receptors  
and a nontoxic disposal system  
makes it extremely unlikely  
that marijuana causes  
any health damage.*

*This logic is supported  
by over 5,000 years  
of recorded use  
without a recorded death.*

*Now we know why.  
Cannabis is as natural as vitamin C.*

**T**HE **N**EW **S**CIENTIST  
*July 31st, 1993*

## CHAPTER TEN

### ***Hydroponics***

If you're comfortable with all the concepts discussed previously and have grown a successful first harvest, you should consider going dirtless.

With a hydroponics flowering system, your plants live in inert rockwool cubes, not soil, while pumps and timers control the flow of nutrient-filled water. Hydro is slightly complicated and costs extra money and also requires you to adjust to a radical way of growing vegetable matter.

*Marijuana is  
one of the least toxic  
medical compounds in the world.*

*It poses far fewer  
pulmonary risks than tobacco  
and is less addictive than alcohol.*

*It is even less deadly than aspirin,  
which causes at least  
1,000 deaths a year.*

USA TODAY EDITORIAL

July 18, 1996

You'll have to find a good hydroponics shop in your area (see Chapter Twelve on security) and spend another \$200. Tell the shopkeeper you want an Ebb and Flow System with a pair of 2-foot by 4-foot plastic trays and a 25-gallon reservoir tub. Along with them you'll buy an aquarium pump with an airstone, a 50-pound bag of Dutch Rocks, a small submersible pump, plastic tubing, timers, hosing adapters and a few dozen 2-inch by 2-inch rockwool cubes. These cubes will have a plastic wrap around each one. Do not remove the plastic until you put the plants into flowering.

Ask the shopkeeper to recommend his best nutrients for lettuce.

While in the store, make sure your friendly shopkeeper shows you how to assemble the system. It basically works by recycling nutrient solution from the reservoir into the large trays (where the plants reside) and back into the reservoir several times a day. Once you see the actual components and get instructions, the system will be quite simple to put together.

At home you'll have to remodel your Flower Room by building a table for your

*Turn again our captivity,  
O Lord,  
as the streams  
in the dry land.*

*They that sow in tears  
shall reap in joy.  
He that goeth forth and weepeth,  
bearing seed,  
shall doubtless  
come again with rejoicing,  
bringing his sheaves with him.*

P<sub>SALMS</sub> 126: 4-6

hydro system. First, sit the reservoir tub on the floor under the light. You'll need eight cinderblocks, stood on end. Put four on one side of the tub, a foot apart, and arrange the other four blocks the same way on the opposite side, four feet away. Cut four 1x4x48-inch pieces of wood and set them on the tops of the cinderblocks, forming supports for the two 4-foot trays.

You can switch to hydro whenever you take fresh cuttings from the Mother. Insert the cuttings into saturated 2x2 rockwool cubes and put them on trays inside the Clone Room under 24-hour light. Remember, test wetness with an empty cube—if you can squeeze a drop, don't add water. When you do, use plain water, no fertilizer. Keep them under florescents. Spritz once a day with water-soluble fertilizer solution until roots appear.

The clones should root within two weeks. As soon as the roots envelop the rockwool—in about two more weeks—remove the plastic wrapping from the cubes and put the plants inside your new Ebb and Flow System in the Flower Room. Arrange the cubes on one of the 4-foot trays. Place

*We found that cannabinoids  
play a crucial role  
in pain processing.*

*Specifically we found that  
cannabinoids depress the reactions  
of spinal neurons  
that transmit pain messages  
back to the brain.*

*The responses of neurons  
that transmit messages  
about non-painful stimuli,  
however,  
are unaltered.*

SOCIETY FOR NEUROSCIENCE,  
“REPORT ON MARIJUANA & ANALGESIA”  
October 1997

them about 2 inches from the inner edge of the tray and make two rows of five plants each. After you've washed the Dutch Rocks with a hose, gently place them in the tray to a level about an inch over the tops of the rockwool cubes, anchoring the plants.

Mix the nutrient solution in a 5-gallon bucket (you'll need 25 gallons for the reservoir). Drape a black plastic sheet over the reservoir to prevent algae. Change the water every 10 days.

The airstone remains in the reservoir tub and stays on all the time. The submersible pump is also in the tub on a timer, delivering the nutrient solution from the reservoir into the trays every three to four hours during the 12-hour light cycle and once in the dark. (Be sure the tray is tilted slightly toward the drain hole so the excess water flows back to the reservoir.)

You can tell almost immediately if something is wrong because of the rapid uptake of nutrients. The most common problem is overfertilizing.

Watch the edges of the leaves. If they begin to curl down at the edges, dilute the nutrients.

Sterile conditions are important. Every time you harvest, you can reuse the Dutch Rocks, but not before scraping off the old roots and rinsing with chlorine bleach. Also clean the trays after each harvest.

Hydroponics is a fascinating growing method, but there's something about traditional dirt that appeals to the purist in me.

*The difference between  
fiction and reality?  
Fiction has to make sense.*

TOM CLANCY

*Now, now my good man,  
this is no time for making enemies.*

VOLTAIRE

*on his deathbed in response to a priest  
asking that he renounce Satan*

## CHAPTER ELEVEN

### *Pruning*

More and more states will be legalizing medical marijuana in the next few years. Some, however, will be placing a limit on the number of plants patients and caregivers can grow. If you find yourself in a state with a limit, there are ways to still do a continuous harvest with a minimum of only five plants at a time.

You can have Mother, two plants in the Clone Room and two in the Flower



*I would rather be  
exposed to the inconveniences  
attending too much liberty  
than to  
those attending  
too small a degree of it.*

THOMAS JEFFERSON  
1791

Room, harvesting once a month. Or you can try pruning and harvesting every other month.

Pruning increases your per-plant yield. Here's how it works: After rooting four clones the usual way, cut off the newest growth tip rising from each stalk. This may seem like a cruel move, but in a week, you'll be amazed to see two growth tips in place of the snipped one. Don't stop there. Every week, snip off each new growth tip and create a little bush.

Keep these plants under 24-hour-a-day lighting. They will keep growing more and more growth tips—for each one you cut off, two will grow in their place.

At some point you'll decide, "This is enough!" and you can put the plants into the Flowering Room. Buds will grow on the end of each tip, and you'll have a bountiful harvest.

This is not as efficient as the Sea of Green technique—that is, it takes more time and light-energy to produce the same amount of medicine—but it works, and no one will ask you as everyone asks of me, "Why grow so many plants!?"

*The prestige of government  
has undoubtedly  
been lowered considerably  
by the Prohibition law.  
For nothing is more destructive  
of respect for the government  
and the law of the land  
than passing laws which  
cannot be enforced.  
It is an open secret that  
the dangerous increase of crime  
in this country  
is closely connected with this.*

ALBERT EINSTEIN,  
*My First Impression of the U.S.A.,  
1921*

## CHAPTER TWELVE

### ***Security in the (Not-so) Free World***

Even if your state hasn't legalized medical marijuana, still tell your doctor you're using it for your condition. Ask him how he feels about it. Make him note it on your chart. Then get a copy of the chart. That's the best way to document your medical need and present a necessity defense in case you are ever arrested.

But let's make sure that doesn't happen. Most busts come from anonymous tips. Jealous friends, nosy neighbors, or

*Be careful,  
and you will save many men  
from the sin of robbing you.*

ED HOWE

kids wanting to get a gold star in DARE class. Never show your plants to anyone except those you trust with your life—and only then on a need-to-know basis.

If possible dispose of plant remains by burning them in your back yard in a compost pile, if that's not possible, carefully place them in a plastic bag and dump them in a dumpster away from your home. Never just jam the branches in with the green trash. Far too many people have been turned in by garbage men.

Your electric bills will go up several dollars a month, the equivalent of running an air-conditioner nonstop. Police in some communities make the electric company red-flag high consumption. But unless you decide to convert your entire basement or two-car garage into a Flower Room, your electric bills shouldn't attract attention.

One warning when buying equipment in person at a lighting or hydroponics store: Use cash, never a credit card or personal check. The DEA has been known to raid these legal shops looking for customer records. Say you are growing gourmet lettuce. Period. Some grow shops are DEA

*Understanding that marijuana has an extremely wide acute margin of safety for use under medical supervision ... [and] concluding that greater harm is caused by the legal consequences of its prohibition than possible risks of medicinal use; therefore [we] encourage research of the therapeutic properties of various cannabinoids and combinations of cannabinoids, and ...urge the Administration and Congress to move expeditiously to make cannabis available as a legal medicine.”*

AMERICAN PUBLIC HEALTH ASSOCIATION,

*November 1994  
Resolution No. 9513:  
“Access to Therapeutic  
Marijuana/Cannabis”*

fronts. If you order by mail, never use a credit card with your own billing address or have the equipment sent to the address where the growing will take place.

People who discreetly grow a few plants indoors at home are the least likely to get caught. That’s why most of the busts you hear about involve hundreds or thousands of plants. These big indoor growers usually do something careless, like having a constant parade of friends drop over (like me) or accidentally cause an electrical fire.

If you have to carry your medicine with you, take only minute amounts. If you have to smoke in your car, use a good air spray.

If you face arrest, however, be polite and cooperate, but don’t answer any questions. You have a right to remain silent. Talk to no one but your lawyer, who will advise you what to do and say.

If you need a lawyer, it is important to find one who specializes in medical marijuana. Too many people get convicted because their lawyer didn’t know the ropes. I advise you to check out the National Organization for the Reform of Marijuana

*“If you love wealth more than liberty,  
the tranquility of servitude better than  
the animating contest of freedom,  
depart from us in peace.  
We ask not your counsel  
nor your arms.  
Crouch down and lick  
the hand that feeds you.  
May your chains rest lightly upon you  
and may posterity forget that  
you were our countrymen.”*

SAMUEL ADAMS  
*After a few beers*

Laws, a group dedicated to bringing an end to this vicious war (<http://www.norml.org>). NORML provides legal tips and lists of lawyers in your area. *High Times* magazine also carries legal information and grow tips (<http://www.hightimes.com>).

Remember, knowledge and common sense are your best defense against the forces of darkness.



Do you think that some states' decision to allow marijuana to be used for medical purposes will lead to the drug's full legalization?

Yes	79 percent	22040 votes
No	21 percent	5880 votes

Do you think "medicinal marijuana" would open the doors for the legalization of other illicit drugs such as heroin?

Yes	11 percent	3204 votes
No	89 percent	24754 votes

Do you support the use of marijuana for medical purposes?

Yes	96 percent	27117 votes
No	4 percent	1060 votes



*This online Poll as of July 30th, 1998 show the reflection of America. Visit:*

<http://cnn.com/HEALTH/9702/weed.wars/>

## CHAPTER THIRTEEN

### *Consuming*

Although this chapter is primarily for first-time medical marijuana users, even experienced consumers will find helpful tips.

As a patient, only you can determine your daily dose of medical marijuana. People in constant pain need to medicate throughout the day from the time they get up, consuming perhaps a quarter-ounce

### Does Your State Have Legislation or a Resolution Recognizing Marijuana's Medical Value?

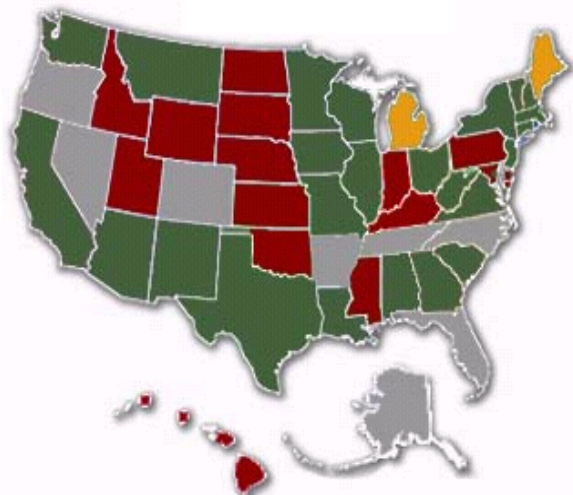

- States with medicinal marijuana legislation or resolution
- States with no medicinal marijuana legislation
- States where medicinal marijuana legislations have expired
- States where medicinal marijuana laws have been repealed

Source: National Organization for the Reform of Marijuana Laws

daily. It adds up quickly: that's seven ounces a month, requiring a monthly harvest of about 15-to-30 plants. Migraine sufferers, on the other hand, might only require a marble-size flower to stop a once-a-week attack and can really scale back their crop.

Interestingly, the federal government — despite insisting marijuana has no medical use—provides low-grade medical marijuana to eight Americans. These patients, who suffer from ailments ranging from glaucoma to AIDS, receive 300 rolled cigarettes a month, more than seven pounds a year. Your continuous harvest would have to turn out 25-to-50 plants a month to equal that.

Fulfilling your need also hinges on potency. The higher the THC, the fewer plants you'll require. In a civilized society, you would be able to go into your neighborhood pharmacy and pick up your doctor's prescription for, let's say, a one-ounce hermetically sealed plastic bag containing germfree medical marijuana with 10% THC content. But since the government refuses to decriminalize medical



*When I find myself  
between two evils,  
I generally pick the one  
I haven't tried before.*

M<sub>AE</sub> W<sub>EST</sub>

marijuana so that it can be regulated like alcohol and tobacco, you'll have to deduce your plants' potency by trial and error.

I can't tell you what will happen to you the first time you try medical marijuana. The high is subjective, affecting people differently. For the vast majority, it works like this: If you smoke medical marijuana regularly, you'll feel the effects within one-to-three minutes after your first inhalation. The first wave is usually the most intense, lasting 15 or 30 minutes before leveling off for about an hour and then gradually tapering off over the next two or three hours.

Patients who smoke all day every day stop getting "high" and can function normally. The medicinal qualities of marijuana, however, continue.

The intensity of the experience is affected by your mood, the setting, and the potency of your plants. I recommend that first-timers sit in a quiet, private room, such as a bedroom. Since you don't know how strong your medicine is, I suggest smoking only one or two puffs at first. While regular users will feel the effects almost im-

*A merry heart  
doeth good  
like a medicine.*

PROVERBS 17:22

mediately, it takes first-timers from 5 or 10 minutes to up to an hour. If you don't feel anything in an hour, try again, this time doubling the dose. If nothing happens at that point, repeat this process the next day.

How will you know when you're stoned? The same way you know when your morning cup of caffeine kicks in or your second beer is giving you a buzz. Your body begins feeling different. Your perception of the world changes. As medical marijuana's analgesic and anti-nausea properties drape you in a comforting veil, the psychoactive effects produce a pleasant mood-lifting euphoria that will take your mind off your suffering and also increase perception, making sights and sounds sharper and more vibrant. Incidence of hallucinations are extremely rare.

As soon as you recognize that you're intoxicated, I suggest first-timers take a deep breath, exhale slowly, lay back, close their eyes, and let the effect wash over them. Relax your body and allow your mind to take you wherever it wants. When you feel comfortable, get up and do what you feel like doing—except operating a car,

*It is the chiefest  
point of happiness  
that a man  
is willing to be  
what he is.*

ERASMUS

bulldozer, or other heavy machinery.

For a small percentage of first-timers, the initial rush can be an unsettling feeling, producing anxiety. This is exceedingly rare. If this does happen to you, however, remember at your low initial dosage, the intensity of the high will diminish within a few minutes and you'll be fine. Lay back, close your eyes, take slow, deep breaths. Remind yourself that the effects are quickly wearing off. The next day, smoke only half as much.

Medical marijuana affects your mental process in largely positive ways. But be warned: if you begin fixating on your problems while high, worrying about the bills or little Johnny's grades, you could have what the hippies call a bumner or bad trip. The key is not to let the drug control you. You are always in charge. You have the ability to change the subject of your inner dialogue and think of something fun.

First-timers always ask, When I get used to smoking, how many puffs should I take in one sitting? The answer is, You'll know. Medical marijuana patients develop this uncanny sense of when to stop, auto-

matically self-regulating dosage. That's why nobody overdoses. In all of recorded history, not one person has ever died from medical marijuana. Compare that to the 100,000 Americans a year who die from using legal prescription drugs according to their doctor's instructions.

Once you get used to the high, you'll be able to function normally. Contrary to government propaganda, you won't turn into a zombie coach potato. I can almost guarantee that you'll become more productive.

And though you've seen Cheech and Chong suck in huge amounts of smoke and turn red holding their breath, you don't have to. Simply inhaling a small amount and exhaling immediately provides the same dosage of THC.

You're probably worried about the long-term effects of smoking on your health. Although the government claims that medical marijuana can cause practically every disease known to mankind including cancer, brain damage and impotency, reputable scientists and physicians have found otherwise. Studies the

*Mirth is like a flash of lightning,  
that breaks through a gloom of clouds,  
and glitters for a moment;  
cheerfulness keeps up  
a kind of daylight in the mind,  
and fills it with  
a steady and perpetual serenity.*

JOSEPH ADDISON

*Based on much evidence,  
from patients and doctors alike,  
on the superior effectiveness and  
safety of whole cannabis (marijuana)  
compared to other medications  
for many patients  
—suffering from the nausea  
associated with chemotherapy,  
the wasting syndrome of AIDS,  
and the symptoms of other illnesses—  
and based on the lack of incentives  
for profit-seeking corporations to  
validate the effectiveness of a  
medicine that cannot be patented,  
we hereby petition the Executive  
Branch and Congress to facilitate and  
expedite the research necessary to  
determine whether this substance  
should be licensed for medical use by  
seriously ill persons.”*

FEDERATION OF AMERICAN SCIENTISTS

*Petition on Medical Marijuana*

*November 1994*

government bases its allegations on have been discredited. The British medical journal, *The Lancet*, determined in 1996 that smoking marijuana, “even long term, is not harmful to health.” In cultures where marijuana use is traditional—for example, Jamaica’s Rastafarians—no difference has been found in the mental and physical health of users compared to nonusers. And no link has ever been found between marijuana and cancer.

I hope this book leads you to down the path to happiness, good health and enlightenment. I’m confident that you will join the millions who swear by medical marijuana. Only the uneducated swear at medical marijuana. If it works for you, share your experiences with others and please don’t stay silent on the issue of legalizing medical marijuana. Contact the media and tell them what an outrage it is to continue arresting the sick and dying for seeking relief with an ancient drug that is safer than aspirin.

If more of us speak up, the government will have to listen, for the truth is on our side.

*In the end,  
The Internet  
will save  
all our butts.*

PETER MCWILLIAMS

## ***Medical Marijuana Information***

[http://www.pdxnorml.org/Dr\\_Mikuriya.html](http://www.pdxnorml.org/Dr_Mikuriya.html)

This must read book is now on-line. “Marijuana: Medical Papers” (1839-1972) Medicine in the Western World has forgotten almost all it once knew about therapeutic properties of marijuana, or cannabis. By Dr. Tod H. Mikuriya.

<http://www.marijuana-as-medicine.org/>

Robert Randall, the first American to gain legal access to marijuana for medical purposes, founded the Alliance for Cannabis Therapeutics (ACT) in 1981. ACT is a non-profit, volunteer organization that provides information on marijuana’s medical use. ACT’s goal is to end the federal prohibition of cannabis (marijuana) in medicine and reform present regulations which inhibit neutral study of the plant’s therapeutic properties.

<http://www.lycaem.org/~sputnik/Ludlow/index.html>

The Fitz Hugh Ludlow Hypertext Collection is dedicated to presenting hypertext and multimedia representations and descriptions of the use of cannabis and other drugs in the 19th and early 20th century, before law forbade the use of these drugs. This is such a great site! Check out [Muggles](#) by Louis Armstrong & his Orchestra (in Real Audio format)

[http://cgi-user.brown.edu/Administration/George\\_Street\\_Journal/pot.html](http://cgi-user.brown.edu/Administration/George_Street_Journal/pot.html)

The legalization of marijuana for medical purposes, already on the books in Florida and Ohio and approved by voters in Arizona and California, has been labeled by the Clinton administration as a cruel hoax. J. Michael Walker, professor of psychology and neuroscience, disagrees. This is an excellent article about marijuana research and pain.

<http://www.rxcannabis.org/>

A Cyberspace Medicinal Cannabis Cooperative.

<http://www.rxmarihuana.com/>

Welcome! Your virtual hosts are: Lester Grinspoon, M.D., Associate Professor of Psychiatry at the Harvard Medical School and James Bakalar, J.D., Lecturer in Law in the Department of Psychiatry at the Harvard Medical School. Authors of the Book; Marihuana - the Forbidden Medicine.

<http://www.marijuanafacts.org/>

Home page for the book Marijuana Myths, Marijuana Facts: a review of the scientific evidence By Lynn Zimmer, Ph.D. and John P. Morgan, MD

<http://www.commonlink.com/users/carl-olsen/HEMP/IHA/elsohly.html>

Interview with Dr. Mahmoud A. ElSohly. In the United States, the University of Mississippi, and specifically its Research Institute of Pharmaceutical Sciences (RIPS), is famous for hosting the NIDA Marijuana Project, which grows the Cannabis it supplies to researchers. The head of this project is currently Mahmoud A. ElSohly, a Research Professor at the institute, as well as its former Assistant Director of Physical Sciences from 1976 to 1988.

He is also the Director of his own private laboratory, where he continues to work with Cannabis and the cannabinoids. This is a must read for anybody interested in discovering the truth about just how much the government really knows about medical marihuana.

<http://www.hightimes.com/ht/tow/med/index.html>

High Times medical marijuana information page.

<http://www.marijuanamagazine.com/>

A great site by medical marijuana patient, and publisher of this book. (*ED NOTE: He'd better say that if he ever wants to see another royalty check in his life.*)

## **215/California Initiative**

<http://Vote96.ss.ca.gov/Vote96/html/BP/215.htm>

Medical Use of Marijuana. Initiative Statute. Official Title and Summary prepared by the Attorney General of California.

<http://www.majority.com/>

This is a very interesting web page listing medical marijuana supporters, mainly Republicans. "As Republicans we believe the government should not interfere with medication decisions between a patient



and his or her physician. It is a disgrace that thousands of people are denied the medication, which their doctors feel, is an essential part of their treatment. Proposition 215 takes such decisions out of the hands of politicians and bureaucrats and leaves them in the hands of the medical experts.”

<http://www.uexpress.com/ups/comics/db/html/controversial/dbcon28.html>

You have got to see these comics. The controversial Doonesbury comics appeared just before the California election, Attorney General Daniel E. Lungren was named directly in the comic as the enemy of the sick and helpless. His response to the comic is posted at this site.

<http://www.rxcannabis.org/BRXCGC/>

The B.Rx.C.G.C. is working towards the implementation of Prop 215 for the citizens of Berkeley California. In the spirit of prop. 215 the B.Rx.C.G.C. is dedicated in assisting those that can grow and those that cannot obtain Medical Marijuana because of a severe illness or disability.

### **Comprehensive Cannabis Information**

<http://hempseed.com/>

A collection of educational information and hemp business

<http://www.commonlink.com/users/carl-olsen/HEMP/IHA/>

The Journal of the International Hemp Association is a bi-annual publication of the International Hemp Association (IHA), Postbus 75007, 1070 AA Amsterdam, The Netherlands. Tel./fax +31 20 6188758, email [iha@euronet.nl](mailto:iha@euronet.nl)

<http://www.hemp.net/>

Hemp.Net is a full service Internet Service Provider. Our Internet accounts include e-mail, newsgroups, 10MB of disk space, shell access and more! Need a second e-mail account or a hip, hemp friendly place to host your personal website? This site has a lot of medical marijuana information as well as all subjects dealing with Cannabis/Hemp/Marihuana.

<http://www.cannabis.com/>

Our primary mission is to provide accurate and unbiased information about cannabis, marijuana, & hemp to the public.

<http://www.foobar.co.uk/users/ukcia/index.html>

The UK’s premier Cannabis web site, for the latest news of the UK Cannabis hemp scene. We’ve got lots planned, including a complete activists guide so you can start campaigning for cannabis law reform in your town.

### **Government Information**

<http://www.nih.gov/news/medmarijuana/MedicalMarijuana.htm>

Report to the Director, National Institutes of Health, by the Ad Hoc Group of Experts. On February 19 and 20, 1997, the National Institutes of Health (NIH) held a meeting concerning the potential medical uses of marijuana. Recent (November 1996) ballot initiatives in California and Arizona had sparked a public health and policy debate on the medical utility of marijuana and the desirability of allowing healthcare providers to prescribe, and patients to receive, marijuana for medicinal purposes.

## Government Misinformation

<http://www.whitehousedrugpolicy.gov/policy/medmj.html>

The Drug Czar Palace Williams Bennett built, currently inhabited by Czar General McCaffrey. The difference between the Drug Warriors and those seeking a sane medical marijuana policy is we link to their sites, but they never link to ours. Whatever could they be afraid of? Here's a sample, from August 4, 1997, five days after my arrest: "The initiatives underway in a number of States have sent a confusing message to our children concerning marijuana that could not come at a worse time. In recent years we have seen drug use by our young people increase at an alarming rate. Among 8th graders, the use of illicit drugs—primarily marijuana—has tripled. This increase in marijuana use has been fueled by a measurable decrease in the proportion of young people who perceive marijuana to be a dangerous substance. Advocates for legalized marijuana have mounted an intense and sophisticated public relations effort to persuade Americans to their point of view..." and so on. Links to all the other pro-medical marijuana prohibition sites can be found here.

## Science

<http://www2.nas.edu/medical-mj/>

Institute of Medicine National Academy of Sciences page on its study, *Medical Use of Marijuana: Assessment of the Science Base*. This is the objective scientific study Czar McCaffrey paid \$1 million for, due out in December 1998. Already on the site are Meeting Summaries from the three public information-gathering meetings already held.

## Law

<http://www.gnv.fdt.net/~jrdawson/lawsuit.htm>

A National Class Action Lawsuit Against the United States Government, seeking declaratory judgments and injunctive relief on behalf of all potential Medicinal Cannabis candidates. The litigation will be initiated in the United States District Court for the Eastern District of Pennsylvania. The Action Class for FREEDOM of Therapeutic Cannabis is totally Grassroots. Please call toll free with your generous DONATION 1-888-LAW-WAR1 or 1-888-LEH-LAW1.

<http://www.hempguide.com/>

Noted Los Angeles defense attorney Bruce Margolin puts more than 25 years courtroom experience behind this publication. A steadfast advocate of the reform of marijuana laws, Mr. Margolin is the Director of Los Angeles NORML, Advisor to Californians for Compassionate Use and Counsel to the California Hemp Initiative.

## CNN, PBS, New Scientist, etc...

<http://cnn.com/HEALTH/9702/weed.wars/>

CNN has really outdone itself with this corner of their web site, titled; Marijuana as Medicine: A smoldering debate moves mainstream.

<http://www.pbs.org/wgbh/pages/frontline/shows/dope/>

This is PBS on line discussing the issues, some of the topics you can explore are; discussion - quiz - marijuana in the body - interviews - a rational discussion - match the crime to the time - how effective

is dare? - laws, sentencing & prices - historical timeline  
- two case histories - regarding my self outing...

[http://www.newscientist.com/nsplus/insight/drugs/marijuana/virtual\\_home.html](http://www.newscientist.com/nsplus/insight/drugs/marijuana/virtual_home.html)

Marijuana Special Report: Only one thing is certain about the great marijuana debate: whether you are Britain's prohibition-mad Home Secretary, or a stoned ex-hippy who would like to dish out the drug for free, you are likely to have a lot more opinions than facts.

### **Organizations Promoting Sane Drug Policy**

<http://www.drcnet.org/>

If you are opposed to Prohibition, or even if you just think the War on Drugs has gone too far, you should fill out our Quick-Signup Form to join the DRC Net Rapid Response Team. Everyone who wants drug policy reform should join this list. It's a low-volume "announcements only" list that won't clutter your mailbox — just the most important action alerts and news items, never more than a few times a week.

<http://www.mapinc.org/>

MAP is a worldwide network of activists dedicated to drug policy reform. We aim to impact public opinion, and especially media coverage, on public policy related to drugs — to create a more balanced view about our drug policies.

<http://www.drugtext.org/>

One of the Internet's first and most comprehensive sites for all information relating to drugs, drug policy and research.

<http://www.freecannabis.org/>

The Cannabis Freedom Fund (CFF) is a non-profit Political Action Committee (PAC) created to unite and spearhead the growing movement to legalize Cannabis for all its many uses and benefits.

<http://www.november.org/>

We are a growing body of citizens whose lives have been gravely affected by our government's present drug policy. We are drug war prisoners, their loved ones and others who believe that our present course of war in America has a price that we cannot afford to pay.

<http://www.famm.org/>

Families Against Mandatory Minimums Foundation (FAMM Foundation) is a national nonprofit organization founded in March of 1991 by attorneys, judges, criminal justice experts, and the families of inmates in response to the excessive penalties triggered by mandatory minimum sentencing policies for nonviolent offenses.

<http://www.norml.org/> after prohibition ends NORML becomes, <http://www.buds.com/>

Since its founding in 1970, NORML is a 501 (c) (3) IRS-approved corporation and has been the principal national advocate for legalizing marijuana. During the 1970s, NORML led the successful efforts to decriminalize minor marijuana offenses in 11 states and significantly lower penalties in all others. Though the decriminalization movement eventually fell victim to the "war on drugs," NORML has remained the nation's principal organization dedicated to ending marijuana prohibition.

<http://www.maps.org/>

The Multidisciplinary Association for Psychedelic Studies (MAPS) is a 501 (c) (3) IRS-

approved corporation chartered in 1986 as a membership-based research and educational organization. Currently numbering 1600 members, MAPS focuses on the development of beneficial, socially sanctioned uses of psychedelic drugs and marijuana.

<http://www.mpp.org/>

The Marijuana Policy Project (MPP) understands that no one policy will solve all problems. Each potentially harmful effect of marijuana consumption and the myriad public and private marijuana control efforts must be thoroughly evaluated. Each policy option should be judged according to whether the overall harm is reduced or increased. Furthermore, public policies must be grounded in the reality that marijuana consumption is already widespread despite the present prohibition laws.

<http://www.ndsn.org/>

The Network is an information-sharing network to provide complete and up-to-date information about current events regarding drug issues. The Network does not take any official positions on policy matters and welcomes membership from all who are concerned about drug problems. The Network also does not support the official positions of the government or other organizations.

<http://www.fear.org/>

Forfeiture Endangers American Rights is a national nonprofit organization dedicated to reform of federal and state asset forfeiture laws to restore due process and protect the property rights of innocent citizens.

<http://gnv.fdt.net/~jrdawson/>

Another great treasure chest of information.

James has been working hard on this for years and in doing so has provided others with a great resource.

<http://www.galaxygallery.com/>

Fun site and very kind people. Medical Bongs Available Here; Galaxy Gallery 7224 Melrose Avenue, Los Angeles, California 90046 The Underground Pipeline (213) 938-6500 FAX (213) 938-0424

### **Information about Dutch Policy**

<http://www.abcnews.com/dispatches/bureaus/amsterdam/amsterdam.html>

Shopping Holland's Open Drug Policy by Nathan Thomas, ABC NEWS. This is a great article that explains a lot about the Cannabis culture in Amsterdam. — The sign on the window reads COFFEE SHOP. A bumper sticker on the door quotes Bill Clinton: YES, BUT I DIDN'T INHALE. And as soon as you open the door, you'll smell what he wasn't inhaling. This is Amsterdam ...

### **SEEDS**

I choose to leave out all the seed companies I did not 100% trust which brought me down to two. These companies are the best at what they do. But they do not ship to America. I have never received seeds through the Internet so I can't really tell you where it is "safe" to shop.

<http://www.sensiseeds.com/>

The grand daddy of all seed companies. On the Net there seem to be companies stating they can deliver our Seeds anywhere in the World. The Sensi Seed Bank BV never gave permission to anyone to sell our seeds

to any country where cannabis seeds are illegal. Please refrain from buying from these companies. Also there are shops that will try to sell you FAKES! The Sensi Seed Bank only has pure F1 hybrid seed lines, these shop's will try to sell you un-pure ones (hybrid's from hybrid's) or they just put one of our Seed names on their bag of birdseed.

<http://www.xs4all.nl/~serious/>

Serious seeds have been bred and stabilized with quality as the highest priority. Stable strains were selected for their unique qualities, then crossed to produce a fuller quality product. After many generations of plant selection, we have come up with some very exquisite Cannabis strains.

#### **Newsgroups**

alt.drugs

alt.drugs.pot

alt.drugs.pot.cultivation

*And in the end,  
the love you take  
is equal to  
the love you make.*

THE BEATLES

And God said,  
Let the earth bring forth grass,  
the herb yielding seed,  
*and* the fruit tree yielding fruit  
after his kind,  
whose seed *is* in itself,  
upon the earth: and it was so.

And the earth  
brought forth grass,  
*and* herb yielding seed after his kind,  
and the tree yielding fruit,  
whose seed *was* in itself,  
after his kind:

and God saw that *it was* good.

**G**OD

*Genesis, Chapter 1,  
Verses 11 and 12*

*(Only 999 words in the Bible precede these)*

*Inside back cover illustration*

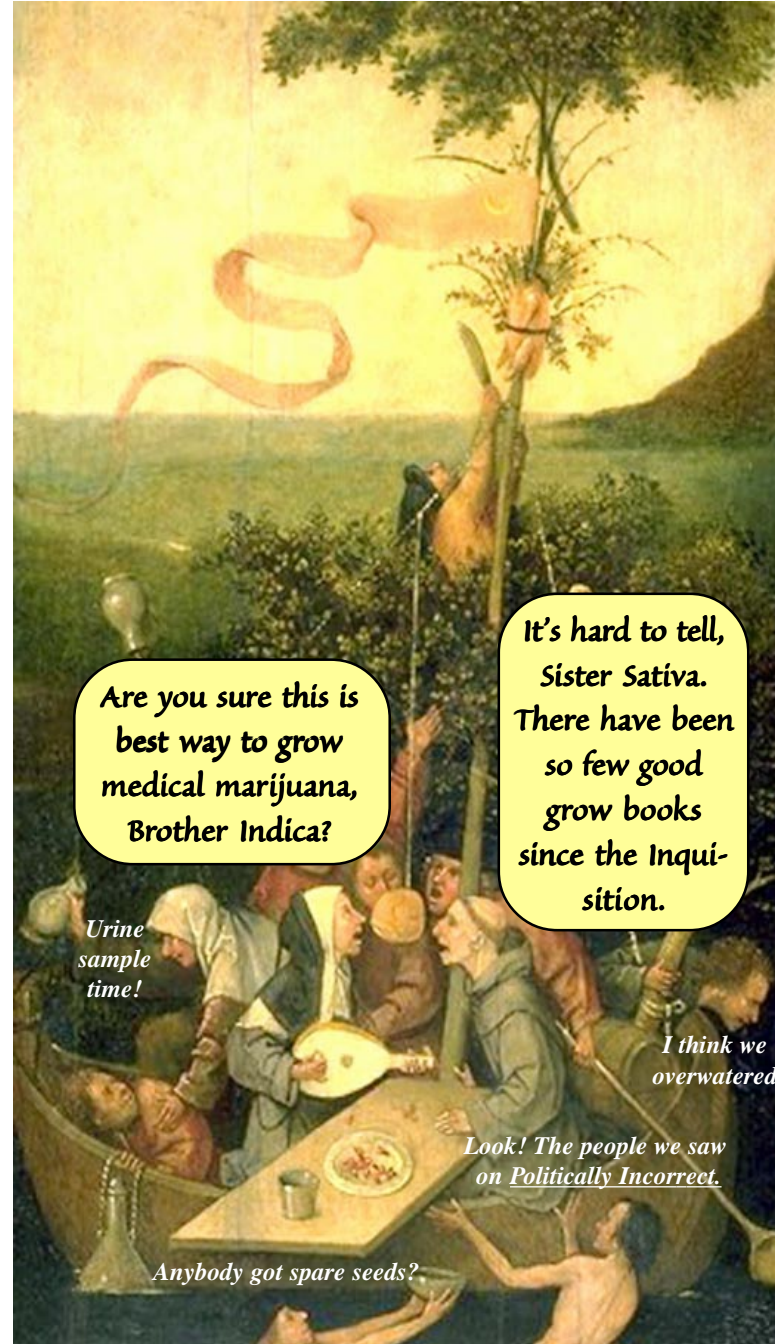

**Are you sure this is  
best way to grow  
medical marijuana,  
Brother Indica?**

**It's hard to tell,  
Sister Sativa.  
There have been  
so few good  
grow books  
since the Inqui-  
sition.**

*Urine  
sample  
time!*

*I think we  
overwatered*

*Look! The people we saw  
on Politically Incorrect.*

*Anybody got spare seeds?*