

Parts

- a | Arm clamp
- b | Square washer
- c | Nut
- d | Spacers x 2
- e | Washer
- f | Allen bolt

Tools Required:
4 mm Allen key,
8 mm open-end wrench

ATTACH CLAMP TO SEATPOST

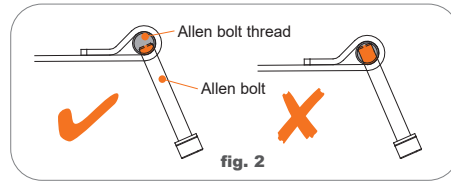
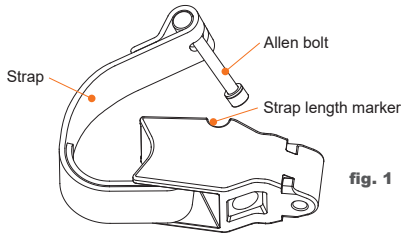

1. Loosen Allen bolt until most of its length is showing (leave last two or three bolt threads attached) (see fig. 2).

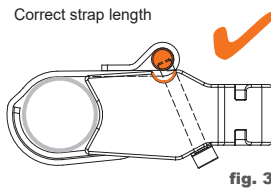

2. Adjust strap length to fit around seat stay (see fig. 3, 4). Strap end of bolt should be parallel with strap length marker (round indent). Wrap the end of strap (with built-in Allen bolt) around seat stay and push it through hole in other side of clamp—fine tune strap length as necessary.

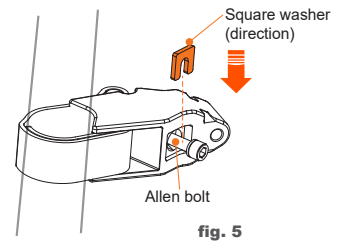

3. When bolt is pushed through hole, strap must be snug, and bolt should be long enough to allow square washer to go behind bolt head. The small, round washer sits on top of square washer (see fig. 5, 6). Tighten bolt very firmly.

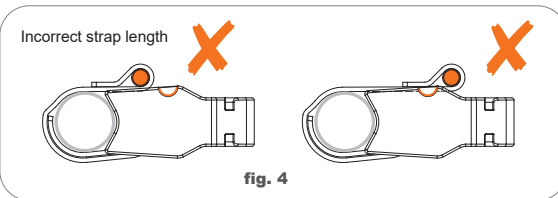

ATTACH CARRIER

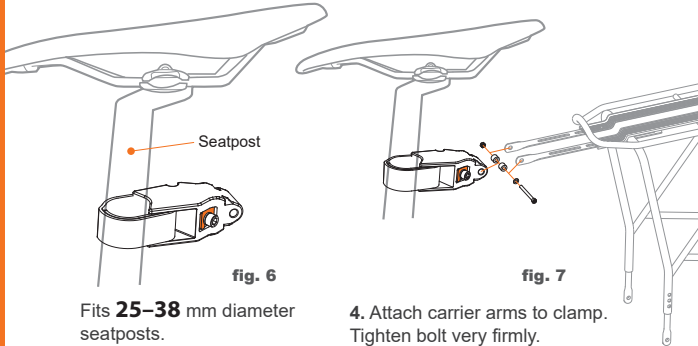

Fits 25-38 mm diameter seatposts.

4. Attach carrier arms to clamp. Tighten bolt very firmly.

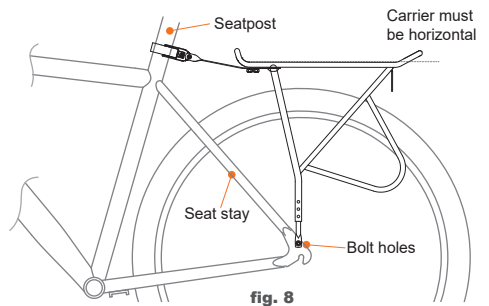

Carrier mounted on bike

Limited Warranty

Ibera warrants this product for normal usage against workmanship, and material defects to the original purchaser for two year from purchase date. Products purchased online are not covered by this warranty unless purchased from an authorised Ibera online store. 1. User assumes all risk of personal injury, damage to or failure of the product when it is used in jumping, acrobatics or similar activities. 2. Warranty does not cover any incidental or consequential damages, such as personal injury or other losses due to accident, neglect, misuse, abuse, modification, normal wear and tear, improper care and cleaning, or failure to follow included instructions.

Warning

Ensure bolts and strap are tight before each use.

See other Ibera products at www.ibera.info

Ibera Co. Ltd.

Specifications subject to change without notice. Ibera is a trademark of Ibera Co. Ltd. All other trademarks are property of their respective owners. Copyright 2019 Ibera Co. Ltd. Made in Taiwan. Artwork: 7-2019.