

WALLKE

Wallkebike.com 



## H6 SERIES

H6 / H6 S/ H6 MAX



**OWNERS  
MANUAL**



















## UNDERSTANDING YOUR H6

This is an exploration of making electric bikes more fun and different. With the 750W motor, full suspension design, full color display, 4" fat tires and hydraulic brakes will bring your cycling experience to another level. You'll be hard pressed to find a bike that offers this amount of versatility with things like the dual batteries and ability to fold.

## UNDERSTANDING YOUR H6 S

This is the range-extended (S) version of the Wallke H6 has the same design concept but also have some different. We have featured the 750W motor, 20Ah battery, hydraulic brake, and full suspension to the foldable frame. A quality offering at a affordable price.









 <b>MODEL</b> Wallke H6 Long Range Ebike	 <b>MOTOR</b> 750W (Sustained), 48V Brushless Rear Hub Motor	 <b>BATTERY</b> Removable Internal Lithium-ion 48V, 20Ah	 <b>DISPLAY</b> LCD Smart Easy Read Display with Backlight, Colorful screen
 <b>BRAKES</b> Hydraulic Disc Brakes, 203mm Rotors, 4 pistons	 <b>TIRES</b> 20" x 4" Fat Tires	 <b>SPEED</b> Up to 28 MPH	 <b>PAYLOAD</b> 350 lbs / 158 kg

 <b>MODEL</b> Wallke H6 S Long Range Ebike	 <b>MOTOR</b> 750W (Sustained), 48V Brushless Rear Hub Motor	 <b>BATTERY</b> Removable Internal Lithium-ion 48V, 20Ah	 <b>DISPLAY</b> LCD Smart Easy Read Display with Backlight, Colorful screen
 <b>BRAKES</b> Hydraulic Disc Brakes, 203mm Rotors, 4 pistons	 <b>TIRES</b> 20" x 4" Fat Tires	 <b>SPEED</b> Up to 33 MPH	 <b>PAYLOAD</b> 350 lbs / 158 kg



## UNDERSTANDING YOUR H6 MAX

Here comes the most enjoyable Wallke H6 Max electric bike! The Max version with 20Ah battery and 750W motor. Wallke H6 Max works with Apple Find My™ (iOS only). Simply add it your Find My list of devices and you'll be able to track where your bike is anytime, anywhere. You can't really go wrong with this ebike.





 <b>MODEL</b> Wallke H6 MAX Long Range Ebike	 <b>MOTOR</b> 750W (Sustained), 48V Brushless Rear Hub Motor	 <b>BATTERY</b> Removable Internal Lithium-ion 48V, 20Ah	 <b>DISPLAY</b> LCD Smart Easy Read Display with Backlight, Colorful screen, with Apple Find My™, With APP
 <b>BRAKES</b> Hydraulic Disc Brakes, 203mm Rotors, 4 pistons	 <b>TIRES</b> 20" x 4" Fat Tires	 <b>SPEED</b> Up to 33 MPH	 <b>PAYLOAD</b> 350 lbs / 158 kg

## Thank You For Purchasing Wallke Ebike!

We take pride in bringing you a quality product that will offer years of enjoyment. Please read and understand this manual fully before assembling and riding your bike.

If you have questions after reading this manual, please contact us by email, or give us a call on the phone.

## We Are Here To Help!

-  **Wallke Ebike Website:** [www.wallkeebike.com](http://www.wallkeebike.com)
-  **Website Service Email:** [sales@wallkeebike.com](mailto:sales@wallkeebike.com)
-  **Amazon Service Email:** [info@wallkeebike.com](mailto:info@wallkeebike.com)
-  **Phone:** 1-323-841-3459

Please attention that Wallke ebike have several sales channels now. Choose the right one to get connected! Email is preferred. Please send your purchase date and order ID so that we can handle your issue faster. Feel free to give us a call when needed.

Order ID: You can find this in the order history of the account the purchase was made through.

## Thanks For Riding Wallke Ebike!

## Take Down Your Serial Numbers Here!

Bike frame serial number

Motor serial number

Display serial number

Where can I find the serial number#?

- The serial number is engraved on the head tube.
- The motor serial number is located on the motor surface.
- The display serial number is stamped on the underside of the display.

**Note:**

Be sure to write down your serial number. You may be asked for your bike's serial number as a part of warranty requests. If the bike is ever stolen, it may be possible to provide local police with the bike serial number to help track it down.

## Where Can I Find My Ebike's Serial Number?

Every bike receives a unique code, serving as a means of identifying a single bike against those of the same model. With this number we can manage the bicycle's warranty in case of a problem, identify the exact model with its year of manufacture or, in the worst case scenario, file a complaint in case of theft, among other things.



- 1.You will likely find your serial number on the motor itself.
- 2.The display serial number can be found at the back of the display.
- 3.The serial number is engraved on the head tube.



# IMPORTANCE

Please read this owner’s handbook carefully before using your H6/H6 S/H6 MAX in order to become thoroughly familiar with the correct operation of your bike’s controls, its features, capabilities, and limitations. This handbook includes safe riding tips, but does not contain any of the techniques and skills necessary to ride an electric bicycle safely.

This owner’s handbook includes assembly and maintenance work which may need to be done at frequent intervals to maintain an operational and safe H6/H6 S/H6 MAX. Never perform work on your H6/H6 S/H6 MAX beyond instructions in this handbook. This handbook is not intended as a comprehensive use, service, repair or maintenance handbook. Do NOT ride your H6/H6 S/H6 MAX if it has been assembled incorrectly. Maintenance beyond what the owner’s handbook instructs is to be handled by an E-Bike specialist or professional cycle mechanic. Riding an incorrectly assembled bike can put your own safety at risk as well as others.

**▲ Disclaimer:** Must be 18 years of age or older to ride

**Note:**

Do not modify, disassemble, or replace the original electrical components on your bike. Doing so will could put you in danger. Riding any type of bike comes with some risks which can’t be predicted or avoided. Taking proper care of bike components can lower the risk of sudden failure of components but cannot prevent it. These sudden failures could cause serious harm, injury, or death to the rider. If you notice abnormalities in any component on the bike, take it to a licensed mechanic to be repaired or replaced immediately. Wallke eBikes assumes no liability for harm, injury, or death of the rider.

# TABLE OF CONTENTS

- IMPORTANCE** ..... P7
- COMPLIANCE WITH THE LAW** ..... P11
- UNDERSTANDING YOUR DRIVE SYSTEM** ..... P12
- UNBOXING** ..... P13
  - HOW TO REMOVE THE BATTERY? ..... P14
  - HOW TO FOLD AND UNFOLD YOUR WALLKE H6 ELECTRIC BIKE? ..... P16
- ASSEMBLY** ..... P17
  - ASSEMBLY INSTRUCTIONS ..... P20
  - USING THE BATTERY KEYS: UNLOCK, POWER ON AND OFF ..... P22
  - ADJUSTING THE FRONT SUSPENSION ..... P22
  - TOOLS AND TORQUE SPECIFICATIONS ..... P23
- OPERATING YOUR NEW E-BIKE** ..... P25
- H6 MAX DISPLAY** ..... P25
  - SYSTEM CONTROL ..... P26
  - DISPLAY SETTINGS ..... P28
  - ADVANCED SETTINGS ..... P30
  - RECOMMENDED PROGRAMMING ..... P31
  - CHANGING ADVANCED SETTINGS ..... P31
- GENERAL OPERATION** ..... P32
  - DISPLAY INTERFACE ..... P32
  - 6KM/H PUSH-ASSISTANCE ..... P33

HEADLIGHT .....	P33
PAS LEVEL .....	P34
USB CONNECTION .....	P34
ERROR CODE .....	P35
PARAMETER SETTING .....	P35
<b>DISPLAY SETTINGS</b> .....	P40
<b>ADVANCED SETTINGS</b> .....	P41
ASSIST LEVELS SETTING .....	P41
CURRENT LIMIT SETTING .....	P41
START STRENGTH SETTING .....	P42
ASSIST SENSITIVITY SETTING .....	P42
RESET TO DEFAULTS SETTING .....	P43
PASSWORD SETTING .....	P43
POWER-ON PASSWORD ENABLE .....	P43
RESET POWER-ON PASSWORD .....	P44
ZERO START SETTING .....	P44
DRIVE MODE SETTING .....	P45
INFORMATION (HARDWARE VERSION) .....	P45
<b>BLUETOOTH FUNCTION</b> .....	P48
<b>KEY-DISP APP GUIDE</b> .....	P53
<b>H6 / H6 S DISPLAY</b> .....	P53
<b>ADVANCED FEATURES</b> .....	P55
CRUISE CONTROL .....	P55
PASSWORD PROTECTION FOR THE ELECTRIC DRIVE .....	P56
WALKING YOUR BIKE .....	P57
USING THE HEADLIGHT .....	P57

DISPLAY INTERFACE SWITCHING .....	P58
BATTERY LEVEL DISPLAY .....	P58
ERROR CODE DISPLAY .....	P59
BACKLIGHT LUMINANCE SETTING .....	P59
METRIC AND IMPERIAL SETTING .....	P60
PAS LEVEL SETTING .....	P61
NUMBER OF SPEED SENSOR MAGNETS SETTING .....	P62
SPEED LIMIT SETTING .....	P63
PEDAL ASSIST SENSITIVITY SETTING .....	P64
ODO RESETS SETTING .....	P65
CONTROLLER CRUISE CONTROL SETTING .....	P66
RESTORE FACTORY SETTINGS OPERATION .....	P67
<b>CARE &amp; MAINTENANCE FOR YOUR NEW E-BIKE</b> .....	P68
<b>SAFETY TIPS</b> .....	P71
<b>BATTERY SAFETY</b> .....	P73
<b>H6 SPECIFICATIONS</b> .....	P74
<b>H6 S SPECIFICATIONS</b> .....	P75
<b>H6 MAX SPECIFICATIONS</b> .....	P76
<b>GENERAL TROUBLESHOOTING</b> .....	P77
<b>ERROR CODES &amp; TROUBLESHOOTING</b> .....	P78
<b>WARRANTY</b> .....	P79

**PLEASE NOTE:**

This manual is not intended as a detailed user, service, repair or maintenance manual. Please seek assistance from a qualified technician for service, repairs or maintenance.

## COMPLIANCE WITH THE LAW

### Read This First: Safety And Compliance With The Law

Congratulations on your purchasing of your new e-bike. Your new e-bike is an excellent piece of personal transportation equipment that will give you good service for many years.

Before you start using your e-bike, we want you to be aware of a few important points. Please read this section carefully..

#### ● Observe Laws Regarding The Use Of Battery-Operated Bicycles

Your e-bike is designed and manufactured to meet safety requirements as a battery-operated bicycle. However, state and local laws governing the use of battery-operated bicycles on public roadways, parks, and other open areas may differ. Please check with your local authority before using your e-bike in public areas.

#### ● Observe Laws Regarding the Use of Bicycles

Note that all laws regarding the use of bicycles in public areas, such as those mandating the use of helmets and the use of infant seats, will automatically apply for e-bikes. Check with your local authority on what restrictions might apply.

#### ● The Lithium-ion Battery Of Your E-Bike

Your e-bike is equipped with the latest battery technology. The lithium-ion battery is much lighter than lead- or nickel-based batteries that are being used in some older models.

#### ● Your First Ride

Please be VERY CAREFUL when you are ready to get on your e-bike for the first time because that the e-bike moves significantly faster than a regular bicycle at active power-assisted mode. Take your e-bike to an area with a lot of open space before you start. Do not start pedaling hard as soon as you get on the e-bike (as you normally would so with a regular bicycle), as the e-bike will accelerate under pedal-assist mode and you may be unprepared for the sudden increase in speed. However, after a few times, you will enjoy using the pedal-assisted function.

## UNDERSTANDING YOUR DRIVE SYSTEM

It's important to understand that the bike has two completely separate (but complimentary) drive systems:

- ◆ an electric drive system that powers the bike through the controller and/or throttle
- ◆ a seven system you power by pedaling yourself

Although the two systems work independently, using them together is what makes the eBike experience so versatile and enjoyable.

**Important note:** Because your drive system is a rear-hub drive, the gear system is for pedal power only, and has no effect on how the electric power system drives the bike.

#### ● Name Of Each Part





## UNBOXING

### ● Preparation Checklist

- ◆ Headlight
- ◆ Battery Charger
- ◆ Front Fender
- ◆ Battery(Pre-installed)
- ◆ 2 x Keys For The Battery(Tie on the handlebar)
- ◆ Saddle
- ◆ User Manual
- ◆ 1 x set of Pedals
- ◆ Tool Kits
- ◆ Rear Seat
- ◆ Front Wheel

Carefully check the package contents, if any parts are missing or damaged, please contact Wallke customer service immediately for assistance with providing your order ID#:

[info@wallkebike.com](mailto:info@wallkebike.com) (Amazon/Walmart)

[sales@wallkebike.com](mailto:sales@wallkebike.com) (Wallke website)

It is recommended to retain the original packaging for a short period of time and keep it as intact as possible.

For warranty and returns, you are responsible for providing a new box at your expense if you have discarded the original box in which the product was shipped. PLEASE RETAIN YOUR BIKE BOX even if it has been damaged in shipping.

▲ Riding a bicycle is an inherently dangerous activity, and it is your responsibility to ride safely and within your abilities. Proper assembly is vital to the safe operation of your bicycle, so seek professional assistance if you are unable to complete the assembly of your bicycle as outlined in this manual.

Before assembling your bike, it is recommended to remove the battery for the following reasons:

- ◆ Determine if the battery is drained or damaged during the transportation.
- ◆ Reduce the weight of the bike to make it easier to maneuver the bike when assembling. Avoid battery damage during assembly.

### How To Remove The Battery?

#### ● Rear Battery

- ◆ Rotate the hinge lock safety upwards to disengage from the fold lock lever.
- ◆ Pull the fold lock lever and disengage it from the frame.
- ◆ Fold the bike at least 90% so the battery can clear the rear frame.
- ◆ Use the correct key to unlock the battery.
- ◆ Using your key in the small slot, pry up the battery pull handle.
- ◆ Use the battery pull handle to slide the battery rearward.



To re-install the battery, align the slot at the side of the battery and reinsert it into the frame. No key is needed.

### How To Charge The Battery?

The battery can be charged both mounted on the bike or separately from the bike. Two keys are supplied to unlock and lock the battery.

- ◆ Plug in the charger into a 120v wall outlet.
- ◆ Connect the charger cable to the battery charging port.

For your first ride, be sure to charge your battery until the light on your charger turns green, depicting a full charge.





We recommend charging the battery for 6-7 hours on the first charge. This will help condition the lithium-ion cells for optimal performance.

**NOTE:**

Never charge the battery in a flammable environment. For safety reasons, the charger and the battery must be placed on a dry, non-flammable surface.

## How to Fold and Unfold your Wallke H6 Electric Bike?

The Wallke H6 folds in the center of the frame as well as at the handlebars. Instructions for folding and unfolding the bike can be found below:

### ● Handlebars

1. Pull the handlebar stem to its upright position.
2. Push the clasp down firmly so that it is locked in position. You should have to use enough force such that the clasp leaves an imprint in your palm. Pull on the clasp with your hand to confirm it is locked and the handlebars cannot fold.
3. To unlock the latch pull up on the black button labeled "open" .
4. Pull the clasp while still holding the "open" button up. You may now fold the stem.



### ● Pedals

1. To fold the pedals push in slightly.
2. Continue pushing down while raising it into its folded position.
3. The pedal will click into place once in the folded position.
4. To unfold the pedals, push the pedals down until you hear an audible click as they lock into the unfolded position.



### ● Frame

1. To unfold the bike frame, grab the handlebar stem and rear end of the bike while standing near where the battery is exposed. Lift the bike slightly off the ground and swing the bike to its closed position.
2. Push down on the clasp firmly until it locks into position. You should have to use enough force such that the clasp leaves an imprint in your palm. Pull on the clasp with your hand to confirm that the clasp has locked and the frame cannot fold.
3. To unlock the bike frame and return it to the folded position, start by sliding the switch labeled "open" to the right.
4. Pull the latch while still holding the switch to the "open" position. You may now fold the bike.



## ASSEMBLY

Please read the instructions entirely before assembly to ensure the proper functioning of the H6/H6 S/H6 MAX. Failure to do so could result in serious personal injury or damage to the bike.

### Assembly Instructions

#### ● Step 1: Handlebar And Stem

1. Begin with handlebars in the folded down position.
2. Simply unfold the stem upward and press the latch inward until there is an audible click.
3. Give the latch a tug to ensure it is locked in place.
4. Push the clasp down firmly so that it is locked in position. You should have to use enough force such that the clasp leaves an imprint in your palm. Pull on the clasp with your hand to confirm it is locked and the handlebars cannot fold.

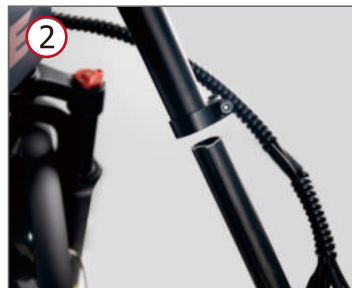

#### ● Step 2: Front Wheel(15 mm Open Wrench)

1. Remove the protective bar from the front fork.
2. Pull out the red/black/gray plastic piece (if it has), which is used to protect the hydraulic brake caliper. Please note this red plastic piece is not part of the brake. (WARNING: Do not pull the brake lever without having either the red pad or the brake disc inserted, as this will damage the hydraulic brake caliper.)
3. Loosen the front wheel screws a little. Align the fork dropouts with the axle of the wheel hub, making sure the dropouts are fully seated on the axle. Also, ensure the brake rotor is properly inserted into the caliper.
4. Tighten the nuts with the tool. Make sure that the front wheel moves freely and does not wobble from side to side. Reposition the wheel and re-tighten if necessary.



#### ● Step 3: Front Fender And Headlight(4mm & 5mm Allen Screw Wrench)

The headlight and front fender are both secured by a single bolt, so the front fender should be installed together with the front light.

1. Unscrew and remove the bolt using the 5mm Allen screw wrench, and reinstall the headlight with the front fender together.
2. Tighten the bolt and connect the light wire (if it disconnects). Pay attention to the arrows on the wire connectors, making sure the arrows align with each other to avoid damaging the interior circuitry.
3. Remove the nuts and washers attached to the front fork which are used to fix the front fender, put the fender iron bar in the right place, then tighten the bolts using the 4mm Allen screw wrench.



● **Step 4: Pedals(15 mm Open Wrench)**

1. Look for a letter marking “L” “R” on each respective pedal and make sure you install the left pedal on the left crank, the right pedal on the right crank.
2. Thread the right pedal onto the right crank gently by hand, turning clockwise. Then tighten pedal by the wrench.
3. Thread the left pedal onto the left crank gently by hand, turning counter-clockwise. Then tighten pedal by Allen wrench.
4. Check the chain alignment. Rotate the right pedal and crank toward the back of the bike as though pedaling backward. Watch the chain and ensure the chain runs through the drivetrain (the rear cog, chain tensioner, and around the front chainring) smoothly

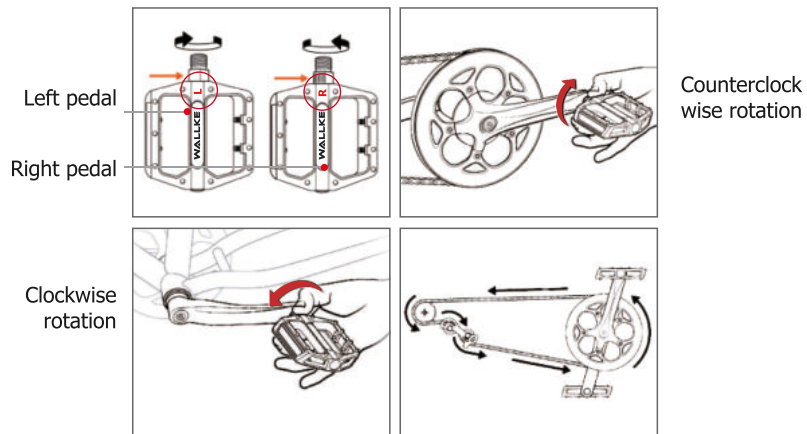

● **Step 5: Rear Seat (Screwdriver)**

1. Loosen clamp screw using screwdriver.
2. Push the rear seat down.
3. Forward to the direction as shown in the below picture(3).
4. Tighten the nuts with the screwdriver tool as shown in the below picture(4).



**Using the Battery Keys: Unlock, Power On and OFF**

Your bike comes with two identical keys to turn your battery on and off. These keys are unique to your bike. For help with lost keys, you may need to replace a new battery head.

The battery has 3 key positions: LOCKED, OFF, and ON. These positions are marked on the battery and can only be seen when the battery is removed from the bike.



- **locked" position - remove the battery**

Turn off the bike. Press and hold the power button on the LCD Display remote (or the power button on the LED remote) until the display turns off.

Use the key to turn off and unlock the battery. Insert the key into the key port, then push and rotate the key to the "locked" position. In this "LOCK" position, the battery pack will NOT be secured to the frame. Please aware the power will also not be active(lock position).



- **"OFF" position - disable the battery power**

In this "OFF" position, the battery pack will be secured to the frame, but the power will not be active.

Note: The key barrel must be in the on-and-locked position for the LEDs to light up.



- **"ON" position - The power will be active**

The power will be active, and the key will be locked into the battery so that it cannot be removed. The key must be turned to the ON position for your bicycle to function.

Note: Be careful not to drop or damage the battery when loose from the bike.

Do not touch the "+" and "-" terminal contacts on the bottom of the battery when the battery is removed from the bike.



## Adjusting the Front Suspension

The firmness of the front suspension can be adjusted for balance between performance and ride comfort.

To adjust suspension firmness, turn the control knob at the top in the direction of the arrow that will increase or decrease the firmness of the ride.



Front Suspension Adjustment

- ◆ For maximum range, lockout the suspension by turning the dial all the way in the ⊕ direction.

Check that your suspension fork is properly adjusted for the terrain and your weight. The suspension fork will affect the handling of the bike, primarily when going over bumps and stopping. In some situations, it may be advantageous to lock out the suspension so it is fully rigid.

- ◆ **Note:** Intensive use of the H6/H6 S/H6 MAX may cause possible damage to the frame and the fork. It is important to inspect the frame and the fork and look for signs of cracks. A broken or cracked frame and fork can cause an accident and injury.

**Note:**

The brand of parts advertised on our website may vary depending on the ongoing supply chain constraints in the eBike market. Component changes may occur without prior notification. All parts have been carefully inspected to ensure they equal the performance standard of the products advertised.

## Tools and torque specifications

The tool sizing listed below is a general guide, but it is possible that the head of a particular bolt on your ebike may vary requiring a different tool (e.g., a 4 mm Allen wrench instead of a 5 mm Allen wrench). If so use whatever tool fits the bolt head. Such differences will not affect the recommended torque for that piece of hardware.

HANDLEBAR AREA		
Stem faceplate bolts (four bolts)	5 mm Allen	8-10 Nm
Stem clamp bolts	5 mm Allen	13-15 Nm
Brake lever clamp bolt	5 mm Allen	6-9 Nm
Handlebar grip bolts	2 mm Allen	3-4 Nm
Throttle clamp bolt	3 mm Allen	2-3 Nm
FORK AND FRONT WHEEL AREA		
Headlight/front fender mounting bolt	4 mm Allen	6-8 Nm
Front axle nut	21 mm wrench	45-50 Nm
Brake rotor to hub bolt	T-25 Torx bit	6-8 Nm
Front wheel torque arm bolts	5 mm Allen	4 Nm
Brake pads to caliper	Needle-nose pliers	90° bend at tip of cotter pin
(SEAT AND BOTTOM BRACKET/CRANK AREA)		
Seat adjustment bolt	6 mm Allen	18-20 Nm
Pedal into crank arm	15 mm pedal wrench	35 Nm
Chainring bolts	6 mm Allen	8-10 Nm
Controller mounting bolts	5 mm Allen	2-3 Nm
Bottom bracket and cups	BBT-22 Park Tool	50-55 Nm

Please use the tool and the torque values appropriate for the component on your ebike.

## OPERATING YOUR NEW E-BIKE





### Powering Up Your eBike

To turn on the electric system and controller, press and hold the  button for 4 seconds.





To turn the system off, do the same. Press and hold the  button for 4 seconds. In addition, the system will turn itself off if the bike is still for 5 minutes. (This time can be changed in Display Settings.)

### Your First Ride

You'll quickly get the feel for your bike and its electric system. For your first ride, you may want to follow these steps:

- 1) turn on the electric system and controller by holding the  button for four seconds.
- 2) If the bike is not showing mode , press the  button until it does (the electric mode is disabled).
- 3) Start off, riding the bike with pedal power.
- 4) When you're steady and stable, press the  button to set mode , enabling the electric assist.
- 5) Being ready for the bike's assist to come in, begin to pedal (after a pedal rotation or two, you will feel the assist come in).
- 6) When you're ready for the bike to move under electric power only, press the throttle slowly until the bike powers forward.
- 7) Brake to a stop when you're ready.

◆ The electric power system won't engage if the bike is already going faster than the mode  range (approximately 10 MPH /16 kph).

After your initial ride, you can experiment with higher modes, using the  and  buttons to change them. (Remember: mode  will turn off the electric drive. Setting mode  or higher will turn it on again.)

### Using The Pedal System

The pedal system will be familiar to nearly everyone, but there are a few practical things that can help you make the best use of it.

- ◆ You can select the best gear for your riding situation using the two buttons on the right handle bar. (The best gear is the one that balances between having to push too hard and having to pedal so fast that you can't really push very much at all.)

- ◆ The gears will only change when you're pedaling forward, so be sure to do so when you're changing gears.
- ◆ A low gear is best for starting to move again after stopping, so be sure to gear down and you're slowing for stop. This will make starting up again much easier.
- ◆ Because your bike is a rear-hub drive model, the gears in the pedal drive system have no effect on the electric drive system.
- ◆ If you want to operate your bike a pedal-only mode, select Mode ① . (see Operating Modes)

## Using The Electric Drive System

The electric drive system can either fully power the bike without your assistance, or can provide assistance when you're pedaling.

### PEDAL-ONLY

In this mode, the H6/H6 S/H6 MAX will perform like a normal bike, as you' ll be riding without any assistance from the motor. This mode is especially useful if you run outof battery, or are looking for more intensive resistance training.

### H6 MAX Display

He H6 Max version has a 986 display, but the H6 and H6 S version use a 81F display. In terms of exterior durability, the 986 display and 81F display are essentially identical in what they offer. The important operation of 986 display can be found below.

986 display can provide a lot of functions to fit your needs. The indicating contents are as

- Battery indicator
- Motor power indicator
- PAS level adjustment and indicator
- Speed function (incl. real speed, Max. speed and Avg. speed)
- Distance (Trip and ODO)
- 6km/h push assistance
- Riding time
- Backlight
- Error code
- USB connection
- Various Parameters Settings (e.g., wheel size, speed-limited, battery capacity setting, assistance level etc.)

## System Control

The electric power system and display are controlled with the handlebar control.

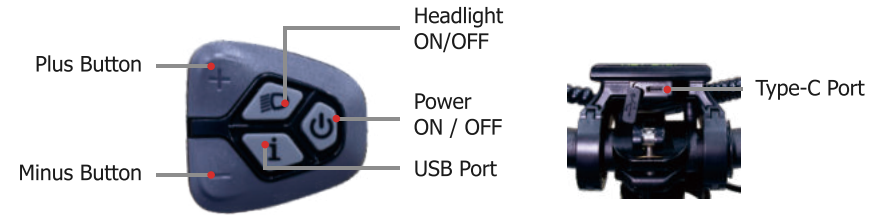

The ⊕ and ⊖ buttons set the electric power mode, and are also used in the settings panels.

The headlight button will switch the headlight on or off. (This system detects low light and will automatically switch on the headlight when needed.)

The ⏻ button powers up or powers down the electric system. (Press for 2 seconds to turn the system on or off.)

The ⓘ button cycles through the modes in the multi-function display.

Your H6 MAX has an USB Type-C charging ports.

It is under the display panel.

## Display Settings

The display settings panel displays and can set the most common parameters you may need to change.

You can go to display settings by:

- 1) press and hold both the ⊕ and ⊖ buttons.
- 2) with DISPLAY SETTINGS highlighted.
- 3) press the ⓘ button to select.

<b>Dormancy</b>	number of minutes of non-use before the bike system turns itself off
<b>TRIP Reset</b>	used to reset the TRIP odometer
<b>AL Sensitivity</b>	/
<b>Toggle Unit</b>	set metric or imperial units
<b>LCD Luminance</b>	display brightness
<b>Password</b>	to require a password before the bike will operate, set the password here
<b>Factory Restore</b>	resets all parameters to factory defaults

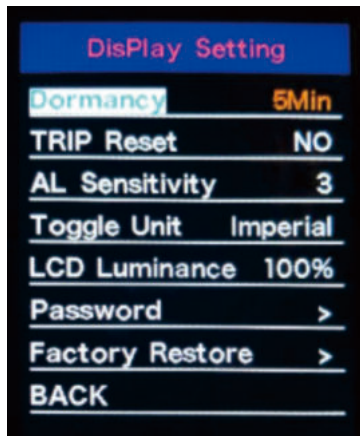

Display Settings Panel

## Dormancy

This sets the inactivity time after which the electric system will power down.

## TRIP Reset

Change this value to YES to reset the trip odometer. This also clears the MAX and AVG speeds.

## AL Sensitivity

Ambient light sensitivity controls how the display responds to low-light environments. This value will determine the point at which the system senses low light and dims the display and turns on the headlight.

## Toggle Unit

This determines whether the display operates in imperial or metric units.

## LCD Luminance

Use this value to set the brightness of the digital display.

## Password

Use this to set a password for the electric system on the bike. When a password is set, the electric system will request and require it before allowing electric operation.

## Factory Restore

Use this to restore the control system to factory defaults.

- ◆ **Note:** Factory Restore will reset all the values on both the Display panel and the Advanced panel.

## Changing Display Settings

- 1) Use the ⊕ or ⊖ buttons to move the highlight up or down.
- 2) Use the ⓘ button to select the highlighted item.
- 3) Once the item is selected, use the ⊕ or ⊖ buttons to change the item' s value. When the desired value is reached, press the ⓘ button to lock in the value.
- 4) Select BACK to return to the higher menu or the main display.

## Advanced Settings

The advanced settings panel contains factory setting not usually adjusted by riders. Use care and good judgement if you decide to change them.

You can go to advanced settings by:

- 1) press and hold both the ⊕ and ⊖ buttons.
- 2) press ⊖ to highlight ADVANCED SETTINGS.
- 3) select by pressing the ⓘ button.

This will bring the advanced setting up in display-only mode. To change the settings, see "Changing Advanced Settings" at the end of this section.

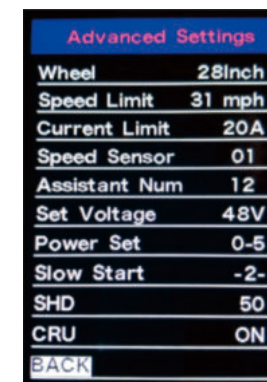

Advanced Settings Panel

<b>Wheel</b>	size of drive wheel (including tire)
<b>Speed Limit</b>	maximum speed supported
<b>Current Limit</b>	maximum current allowed by the controller (this protects the motor and controller – changing this value can significantly reduce the life of both)
<b>Speed Sensor</b>	number of magnets in the speed sensor
<b>Assistant Num</b>	sensitivity of the assist systems
<b>Set Voltage</b>	controls how the battery charge display interprets the voltage levels of the battery
<b>Power Set</b>	number of modes available (sub-menu defines each mode’s max power %)
<b>Slow Start</b>	delay before motor begins to assist
<b>SHD</b>	must be 0% to protect the controller
<b>CRU</b>	cruise control ON/OFF

◆ **Note:** Some of the advanced settings configure the controller and display for the exact hardware of the bike. Changing these settings can cause the bike to malfunction, or could potentially damage certain components. Changing these settings is unlikely to improve the bike.

## Wheel

This sets the size of the wheel for the purpose of calculating speed from wheel rotations. With the 4” fat tire, the 26” wheel behaves like a 28” wheel on this bike.

## Speed Limit

This sets the upper limit of speed where power assist will be provided. You can set this to be consistent with local regulations.

## Current Limit

This controls the automatic protection circuit in the controller so your battery and motor are protected. Changing this from the factory setting won’t improve the bike’s performance, but it will disable important protections designed to prevent very costly repairs.

## Speed Sensor

This is factory set to let the controller know what type of speed sensor is used in the bike. Changing this will make the controller incapable of functioning properly.

## Assistant Num

This sets the force provided by the power assist. The value ranges from 4 (greatest power provided for assist) to 24 (least power on assist). Think of these as setting how gentle the assist will be: 4 (not so gentle) to 24 (very gentle).

## Set Voltage

Sets the behavior of the battery monitor as it translates battery voltage into the battery charge and percentage indicator on the display. Changing this from the factory settings will usually make the battery charge display less accurate.

## Power Set

Changing your Power Set from the default 0-3 to 0-5 will give you more speed ranges to choose from when riding. As part of changing to a new power set, you can also change the percentage of total available power that drives each mode. These setting will control the approximate speed at the upper limit of each mode.

Other eBikes may come with different configurations, and you may decide to customize your Power Set for better compatibility with those of other riders, or to give you finer control of the speeds of the Power Set (modes and speed points) on your bike.

## Slow Start

Slow Start sets the delay from the start of pedaling to the time the assist begins. Lowering this number will have the assist come in sooner, raising it will give a little more time for you to stabilize your effort before the system comes in.

## SHD

This setting is not compatible with the hardware in the bikes up through 2021 and should be set at 0% to protect the controller.







## CRU

This enables or disables the cruise control feature. Cruise control is disabled (OFF) by default.



## Recommended Programming

To provide a larger number of defined speed / power ranges, you may choose to take advantage of the controller's programmability to create a more versatile Power Set.







To do so, change the Power Set to 0-5. After you select this with the  button, a small menu will appear where you set the power levels of each mode from  - . Enter the following power levels, using  and  to change each value, and then the  button to lock in the value.

<b>1 – 40%</b>
<b>2 – 50%</b>
<b>3 – 67%</b>
<b>4 – 85%</b>
<b>5 – 96%</b>

These setting will deliver a wider range of speeds, including a lower speed for mode .

## Changing Advanced Settings

To change advanced settings, use this method to enter the Advanced Settings panel:

- 1) press and hold both  and  and  buttons.
- 2) OK will briefly appear in the lower right of the display.
- 3) press and hold both the  and  buttons.
- 4) press  to highlight ADVANCED SETTINGS.
- 5) select by pressing the  button.
- 6) now the settings can be selected and changed.

## GENERAL OPERATION

### Definition of Button

The H6 MAX display matches the K43 remote, and there are 4 buttons: including on/off, I key, plus key/headlight key, minus key/boost key; in the subsequent instructions, the word "ON/OFF" is used for the on/off key Replacement; the  button is replaced by the word "I"; the plus/headlight button is replaced by the word "UP"; the minus/boost button is replaced by the word "DOWN".

### Power on/off

After long pressing the "ON/OFF" button for 2 seconds, the display will turn on and the whole system will work normally. In the power-on state, long press the "ON/OFF" button to turn off the power of the e-bike.

- ◆ When parking the E-bike for more than 5 minutes, the E-bike system switches off automatically.

### Display Interface

After switching on the E-bike system, the display will show Real Speed and Trip Distance(KM) as default. Pressing the  button to switch between following items:  
Trip (Km) → ODO (Km) → Max. Speed (Km/h) → Avg. Speed (Km/h) → Riding Time (Min.)



Display Interface

### 6km/h Push-assistance

Hold the "DOWN" button will activate the push-assistance function, after 2s, the Ebike will travel at a uniform speed of 6 Km/h while the screen displays "  ". The pushassistance function is switched off as soon as you release the "DOWN" button. The E-bike system stops the power output immediately, and back to the status before push-assistance mode.

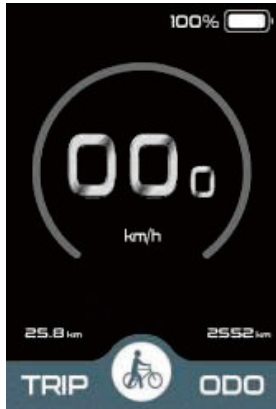

Push-assistance Mode

### Headlight

Press and hold the "UP" button for more than 2 seconds to turn on the headlights. After turning on the headlights, the brightness of the backlight will decrease. Press and hold the "UP" button for more than 2 seconds to turn off the headlights and restore the brightness of the backlight.



Headlight Interface

### PAS level

Short press the "UP" or "DOWN" button to switch the power assist gear of the electric vehicle and change the output power of the motor. The default output power range of the display is PAS level 0-5. PAS level 0 stop power output, PAS level1 is the minimum power, PAS level 5 is the maximum power. As shown in the figure, it is PAS level 1.

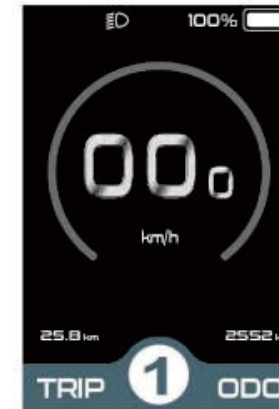

Assist Level Interface

### USB connection

When the display is plugged into a USB external device, the meter will display the interface as shown in the figure below.

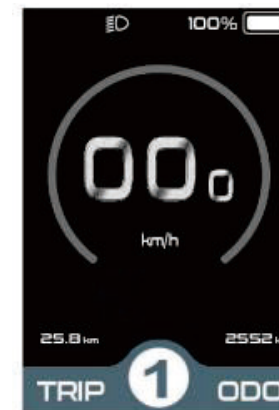

USB Connection Interface

### Error code

When the electronic control system fails, it will automatically display the error code. Here is the detailed message of the error code in Attached list 1.



Error Code Interface

- ◆ When an error code is displayed, please remove the fault in time, the e-bike will not be able to run normally after a fault occurs.

### Parameter setting

Long press the "ON/OFF" button to power on. In the power-on state, when the e-bike is stationary, press and hold the "i" button for more than 2 seconds, and the display enters the setting state. Including Display setting (display settings), Advanced settings (advanced settings) and Information (software information)

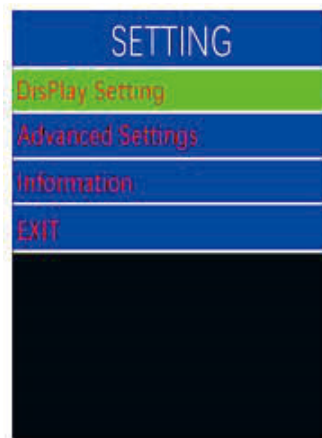

Setting Interface

- ◆ All the settings are operated on a parked e-bike.

## DISPLAY SETTINGS

### Trip Reset

Short press "i" to confirm, short press "UP" or "DOWN" to switch between "NO (not clear)" and "YES (clear)"; (clear data includes maximum speed (MAXS), average speed (AVG), Trip (TRIP), riding time (Time)), short press "i" again after confirmation, save and exit to "TRIP Reset".

Press and hold the "i" key to exit to the main interface or press "BACK" to exit to the main interface. The above data will not be automatically cleared when the display is turned off or the e-bike is powered off.

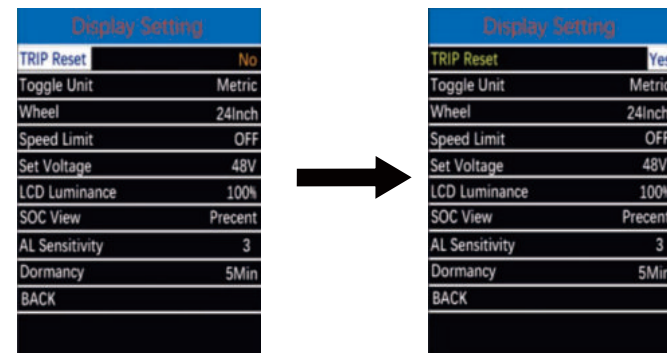

Trip Reset Interface

### Toggle Unit

Press the "UP" button or the "DOWN" button to choose the "Toggle Unit", and then press the "i" button to enter unit settings, press the "UP" button or the "DOWN" button to switch between "Metric" and "Imperial", press the "i" button to save and exit "Toggle Unit". The default value is "Metric".

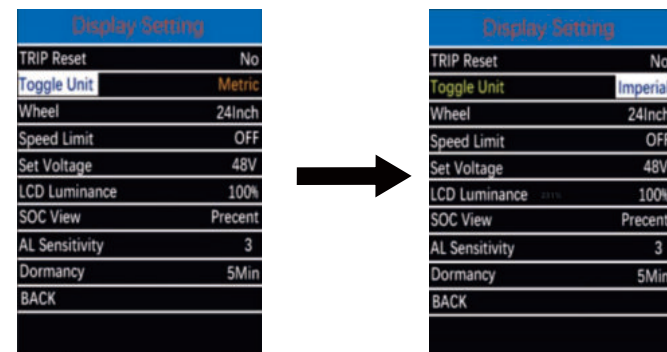

Toggle Unit Interface

### Wheel Diameter Settings

“Wheel” represents wheel diameter settings. Press the “i” button to enter wheel diameter settings. To change basic settings, press the “UP” or the “DOWN” button to select the desired value. The values can be selected are “16” / “ 18” / “ 20” / “ 22” / “ 24” / “ 26” / “ 700c” / “ 28” , press the “i” button to save and exit “Wheel” .

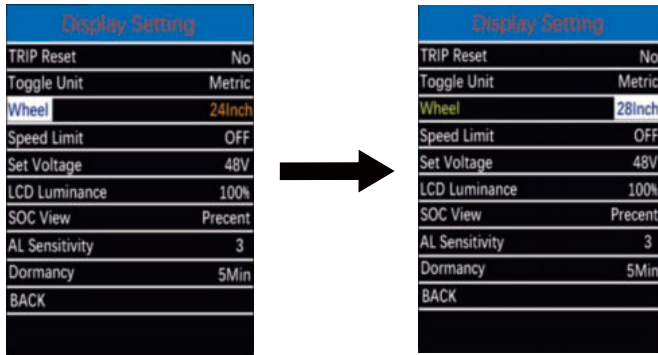

Wheel Diameter Settings Interface

### Speed Limited Settings

“Speed Limit” represents speed limit settings. Press the “i” button to enter speed limit settings. To change basic settings, press the “UP” or the “DOWN” button to select the desired value. The range is “12-39(km/h)/off” , the default value is no speed limited, press the “i” button to save and exit “Speed Limit” .

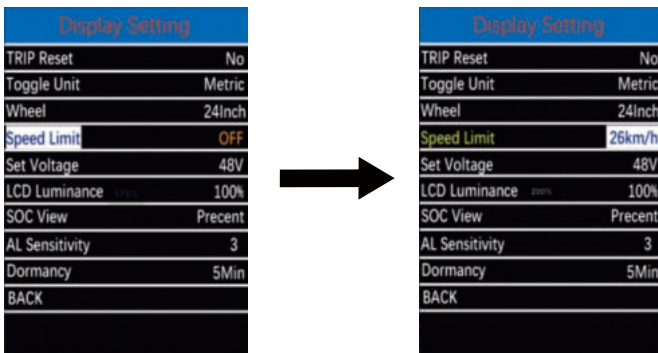

Speed Limit Setting Interface

### Voltage Value Setting

“Set Voltage” represents the battery power setting, short press the “i” key to enter the battery power setting interface. Short press “UP” or “DOWN” to switch the voltage value to support 36V 48V, and then short press “i” to enter the voltage node switch, “31.5” is the first power value, by short pressing “UP” or “DOWN” button to increase /minus to change the value, short press the “i” button to confirm and enter the next power setting interface; after the 5 power values are set, short press “i” to save the settings and return to “Set Voltage”.



Voltage Setting Interface

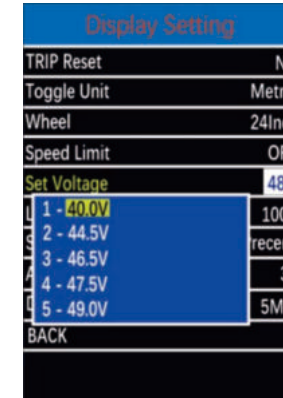

Voltage interface

### LCD luminance settings

“LCD Luminance”, indicates the backlight brightness setting. Short press “i” to enter the setting, by short pressing “UP” or “DOWN”, the backlight brightness range is “100%-75%-50%-30%-10%” 5 levels of brightness, 100% corresponds to the highest brightness, 10 % corresponds to the lowest brightness; short press “i” to save and exit to “LCD Luminance”.

Display Setting	
TRIP Reset	No
Toggle Unit	Metric
Wheel	24Inch
Speed Limit	OFF
Set Voltage	48V
LCD Luminance	100%
SOC View	Precent
AL Sensitivity	3
Dormancy	5Min
BACK	



Display Setting	
TRIP Reset	No
Toggle Unit	Metric
Wheel	24Inch
Speed Limit	OFF
Set Voltage	48V
LCD Luminance	75%
SOC View	Precent
AL Sensitivity	3
Dormancy	5Min
BACK	

LCD Luminance Settings Interface

Display Setting	
TRIP Reset	No
Toggle Unit	Metric
Wheel	24Inch
Speed Limit	OFF
Set Voltage	48V
LCD Luminance	100%
SOC View	Precent
AL Sensitivity	3
Dormancy	5Min
BACK	



Display Setting	
TRIP Reset	No
Toggle Unit	Metric
Wheel	24Inch
Speed Limit	OFF
Set Voltage	48V
LCD Luminance	100%
SOC View	Precent
AL Sensitivity	4
Dormancy	5Min
BACK	

AL Sensitivity Setting Interface

### SOC settings

"SOC View" represents two display methods of remaining battery capacity. One is a percentage and the other is a voltage value. Short press the "UP" or "DOWN" button to select the desired display mode. Short press "UP" or "DOWN" to select voltage, percentage "Voltage"/"Percent" two modes, short press "i" to save and exit to "SOC View".

Display Setting	
TRIP Reset	No
Toggle Unit	Metric
Wheel	24Inch
Speed Limit	OFF
Set Voltage	48V
LCD Luminance	100%
SOC View	Precent
AL Sensitivity	3
Dormancy	5Min
BACK	



Display Setting	
TRIP Reset	No
Toggle Unit	Metric
Wheel	24Inch
Speed Limit	OFF
Set Voltage	48V
LCD Luminance	100%
SOC View	Voltage
AL Sensitivity	3
Dormancy	5Min
BACK	

Voltage Display Setting Interface

### Auto Power-off Time

"Dormancy" represents the automatic shutdown time of the meter. Short press "UP" or "DOWN" to select "Dormancy", short press "i" to enter the setting, short press "UP" or "DOWN" to select the automatic shutdown time range, the automatic shutdown time range is "9-8-7- 6-5-4-3-3-2-1-OFF" (Min), short press "i" to save and exit to "Dormancy".

Display Setting	
TRIP Reset	No
Toggle Unit	Metric
Wheel	24Inch
Speed Limit	OFF
Set Voltage	48V
LCD Luminance	100%
SOC View	Precent
AL Sensitivity	3
Dormancy	5Min
BACK	



Display Setting	
TRIP Reset	No
Toggle Unit	Metric
Wheel	24Inch
Speed Limit	OFF
Set Voltage	48V
LCD Luminance	100%
SOC View	Precent
AL Sensitivity	3
Dormancy	6Min
BACK	

Auto Power-off Time Setting

### AL Sensitivity Settings

"AL Sensitivity" represents the sensitivity of light perception. To change the value, short press the "UP" or "DOWN" button to select the sensitivity value. The light sensitivity value range is "5-4-3-3-2-1-OFF", short press "i" to save and exit to "AL Sensitivity".

# ADVANCED SETTINGS

## Assist Levels Setting

"Power Set" stands for power boost gear mode. There are 6 modes available: 0-3, 1-3, 0-5, 1-5, 0-9, 1-9. Change the assist gear range by short pressing "UP" or "DOWN",short press "i" to save and exit to "Assist Levels".

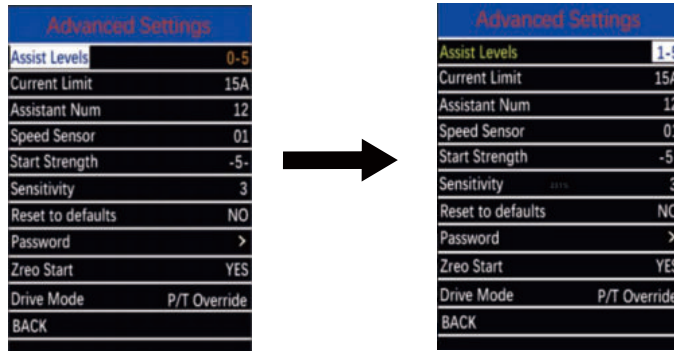

Assist Levels Setting

## Current limit setting

"Current Limit" indicates the current limit value setting. The adjustable range is "6A-20A". Change the maximum current value of the controller by short pressing the "UP" or "DOWN" key. Short press "i" to save and exit to "Current Limit".



Current Limit Settings Interface

## Start Strength Setting

"Start Strength" indicates the start strength setting. Select the desired value by short pressing the "UP" or "DOWN" key. The range is "5-4-3-2-1-0", short press "i" to save and exit to "Start Strength"

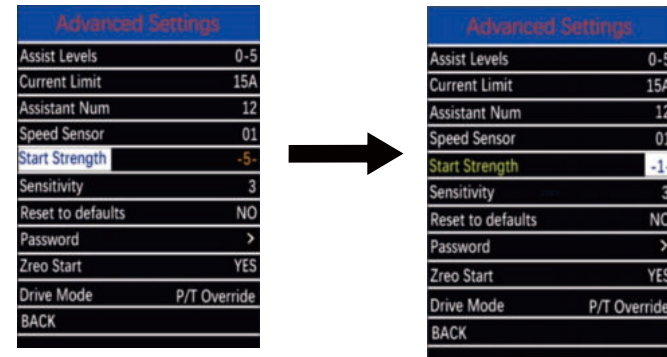

Start Strength Setting Interface

## Assist Sensitivity Setting

"Sensitivity" stands for assist sensitivity. Select the assist sensitivity value by short pressing the "UP" or "DOWN" button. The power assist sensitivity range is "3-24", short press "i" to save and exit to "Sensitivity".

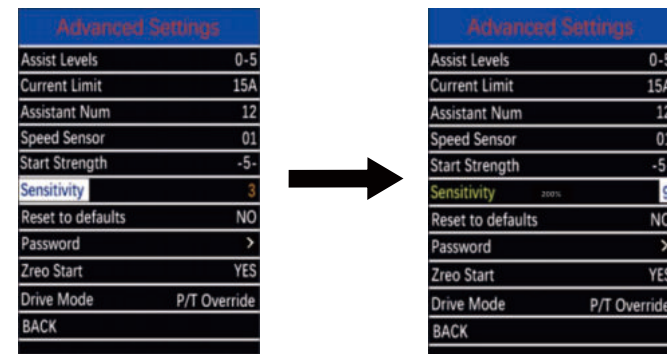

Assist Sensitivity Setting Interface

## Reset To Defaults Setting

Short press "UP" or "DOWN" to select "Reset to defaults", short press "i" to enter the setting, short press "UP" or "DOWN" to switch between "YES" (restore factory settings) / "NO" (do not restore factory settings), short press "i" to save and exit to "Reset to defaults".

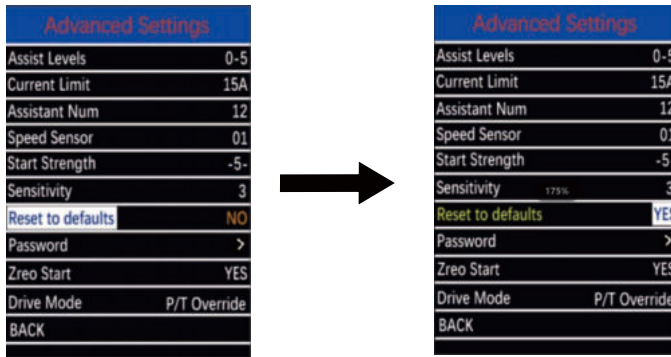

Reset To Defaults Setting Interface

### Password Setting

Short press "UP" or "DOWN" to select "Password", short press "i" to enter the setting, then short press "i" to select Start PassWord; short press "UP" or "DOWN" to switch " OFF (closed)"/"ON (open)", the following is the specific switching method.

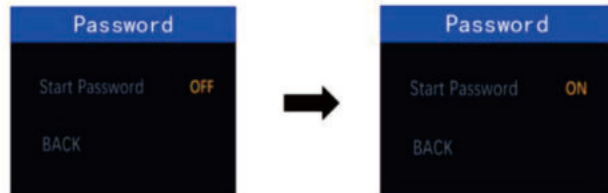

Password Setting Interface

### Power-on Password Enable

After selecting "ON" in the "Start PassWord" interface, short press "i" to confirm, the interface prompts to enter the password, short press "UP" or "DOWN" key to enter the value, short press "i" key to shift, 4 digits After the password is entered, short press the "i" key to confirm; the interface prompts to enter the password again. After the two inputs are consistent, the system prompts that the password is set successfully. If the two inputs are inconsistent, you need to repeat the first step to enter a new password and confirm. After the 2S interface automatically jumps to the original setting interface.



Password Enable Setting Interface

### Reset Power-on Password

After the password is enabled, the "Pass word" interface will add a "Reset Password" option, press "UP" or "DOWN" to select "Reset Password", press "i" again to confirm, and the interface reminds to enter the current password. After the input is correct, the interface reminds to enter a new password, and the subsequent operations are consistent with the new password settings. After the password is successfully modified, then 2S the interface automatically jumps to the original setting interface.

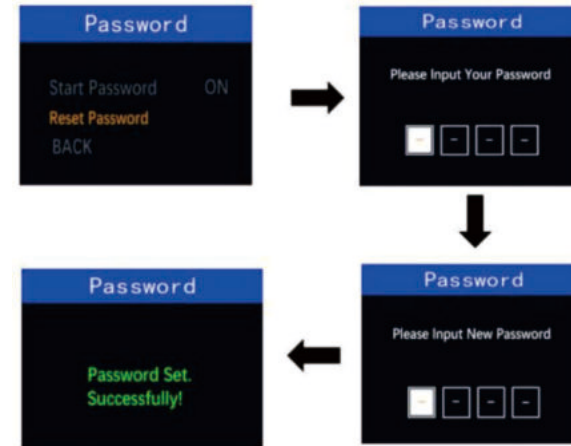

Power-on Password Resetting Interface

### Zero Start Setting

Short press "UP" or "DOWN" to select "Zreo Start", short press "i" to enter the settings, short press "UP" or "DOWN" to switch between "YES" (zero start) / "NO" (nonzero start), short press "i" to save and exit to "Zreo Start".

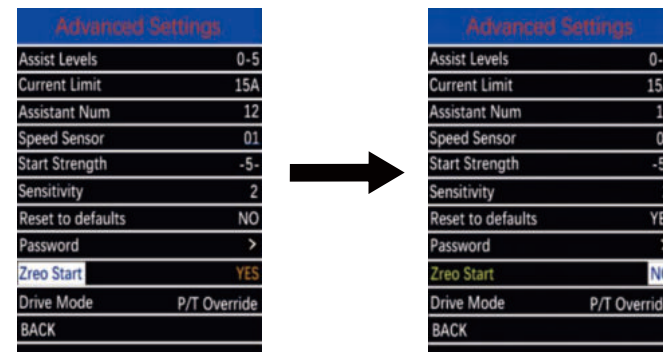

Zero Start Setting Interface

### Drive Mode Setting

Short press "UP" or "DOWN" to select "Drive Mode", short press "i" to enter the setting, short press "UP" or "DOWN" to switch between "P/T Override" (coexistence) / "PAS Only" (assist Drive) / "Throttle only" (electric drive), short press "i" to save and exit to "Drive Mode".

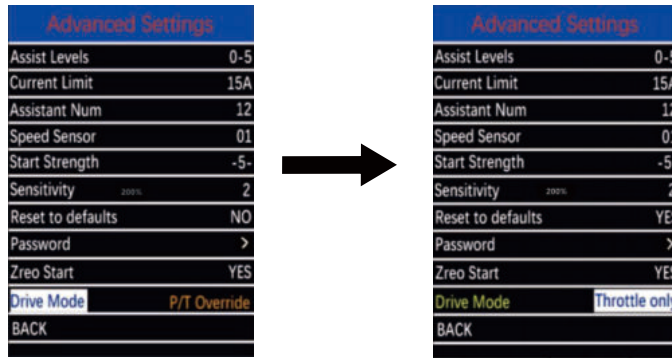

Drive Mode Setting Interface

### Information (hardware version)

Short press the "i" key to enter "Information", you can view the software information. Press and hold the "i" key to exit to the setting interface or press "BACK" to exit to the setting interface.

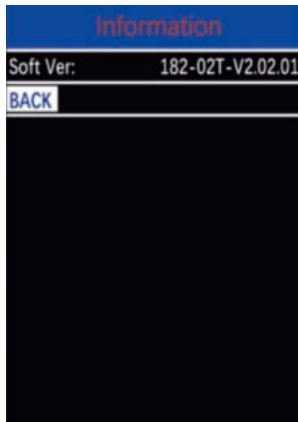

Hardware Version Interface

◆ **Remarks:**The software version number is only used for internal retrospective use of Key-Disp

## BLUETOOTH FUNCTION

### APP Bluetooth Device

Open the Key-Disp APP and enter the APP homepage, click "My-More Devices-APP Device" to search for Bluetooth to add the display, click "Searched Bluetooth DevicesFinish", the display will show the symbol, which means the connection is successful.

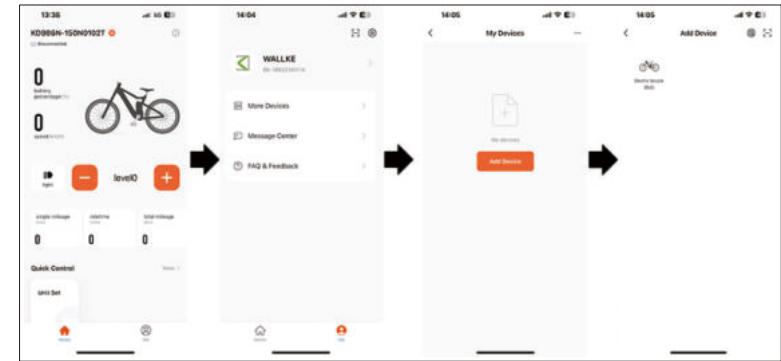

The Bluetooth device is added successfully Interface

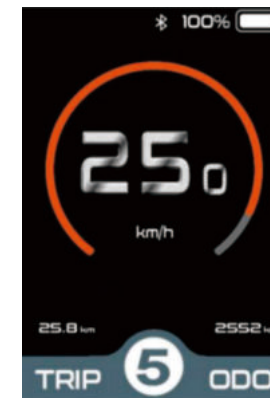

Bluetooth Connection Success Interface

### Adjust the PAS Level

After the Bluetooth connection is successful, you can use the "+" and "-" functions in the Key-Disp APP to increase or decrease the PAS level of the e-bike to change the output power of the motor. PAS level 0 means no power assist output.



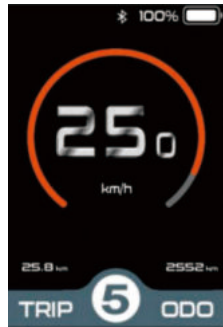
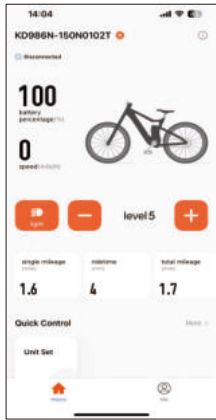

Adjust the PAS Level by APP

### Turn on the Headlight

After the Bluetooth connection is successful, you can turn on the headlights through the "Headlights" function of the Key-Disp APP. After turning on the headlights, the brightness of the backlight will decrease. Click "Headlights" again to turn off the headlights, and the brightness of the backlight will return to the original brightness.

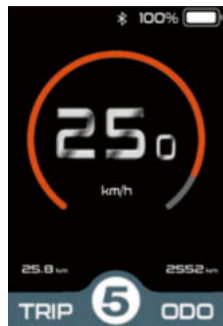
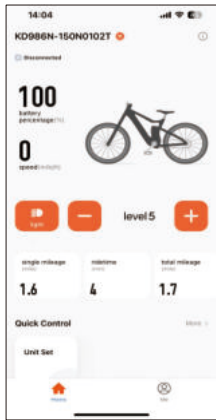

Turn on the headlight by APP

### Multi-system switching

After the Bluetooth connection is successful, multiple Bluetooth systems can be switched through the Key-Disp APP.



Multi-system switching Interface

## KEY-DISP APP GUIDE

### Downloads

Download from apple store/google store by key words "Key-Disp" . App logo is as follows:



### Sign Up and Log In

In order to use all functions of Key-Disp app, users should sign up first. Please fill in the required information according to pictures below, click "Get Verification Code" and request to enter the verification code. Check the code in your email account used for the register process and enter the correct code. Then you can log in.

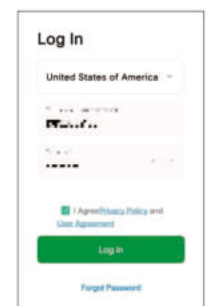
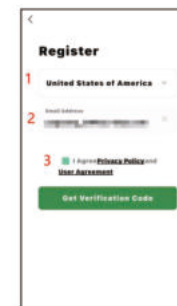

### App connection

App must communicate with the ebike system to realize all its functions. When display is on, Add Device -> Add -> + > Done



### App operations & indication info

Bluetooth connection icon, battery power, speed, trip distance, riding time and ODO. The app can be operated to control the headlight status of the whole bike and switch the assist levels on the display.

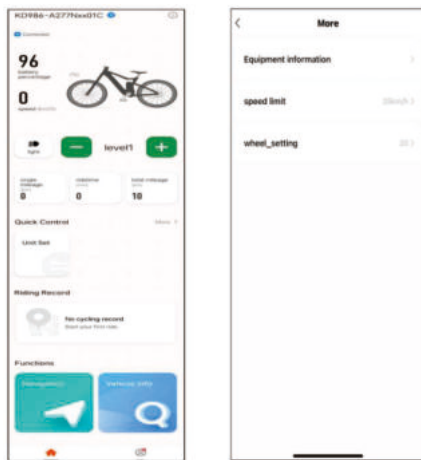

### Fast operations

Fast operations: unit set (metric vs imperial), speed limit set, wheel size set.

- ◆ **Remarks:** if display complies with new EN standard, wheel size and speed limit are not settable on either display side or app side.

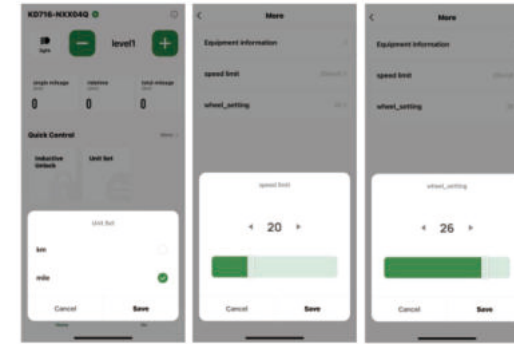

- Map navigation, Vehicle check-up.

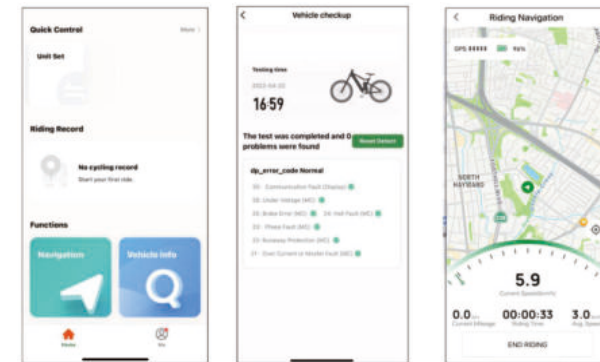

- Riding record: if single trip distance is > 0.1km, the riding record will be saved.

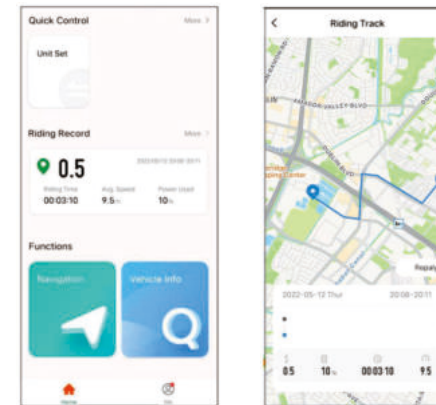

- Help and guide: click the icon to view FAQ and feedback.

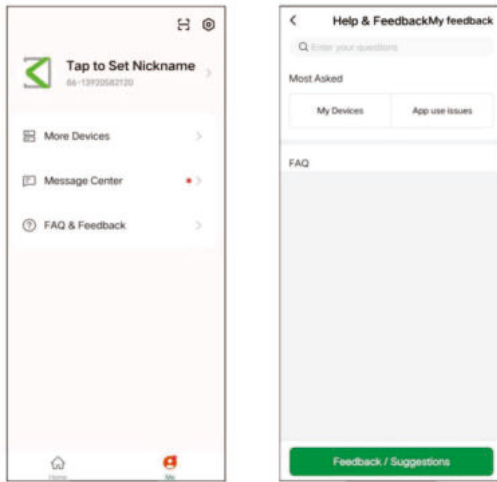

## How to use FIND MY

- Activation:
  - ◆ Press and hold the "+" button for more than 3s, then release it. Activate display function.
- Connection:
  - ◆ Open "Find My" application from your iPhone. Click the "Add Item" -- "Other Supported Item" -- "Connection" --Name your display--Choose an Emoji to represent your display--Agree the display link to your Apple ID. Then you can find the display in your iPhone.

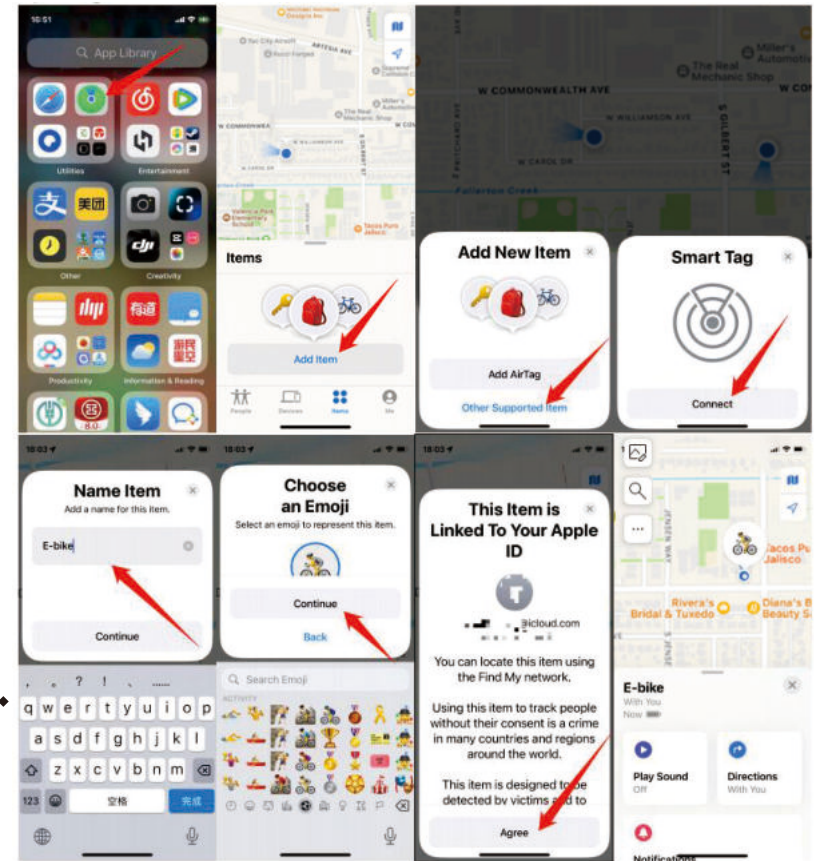

- Bluetooth connection and remove:

- ◆ After Bluetooth display has been paired with APP for the first time, it will automatically connect to the app.

**Note:** mobile network must be turned on for Bluetooth connection.

- ◆ Remove the Bluetooth display.

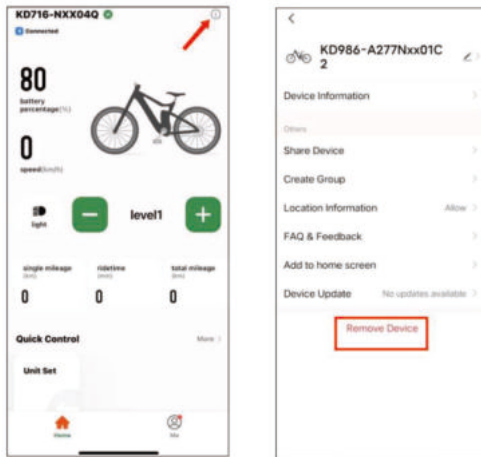

- Solution for: app unable to search Bluetooth device:

- ◆ When the device is powered on, press and hold the "i" and "-" for 2S at the same time, or make the display reset to factory settings.

- Remove the Device:

Find your device from "Find My". Slide to the bottom of the screen. Click the "Remove Item" -- "Remove" -- "Remove".

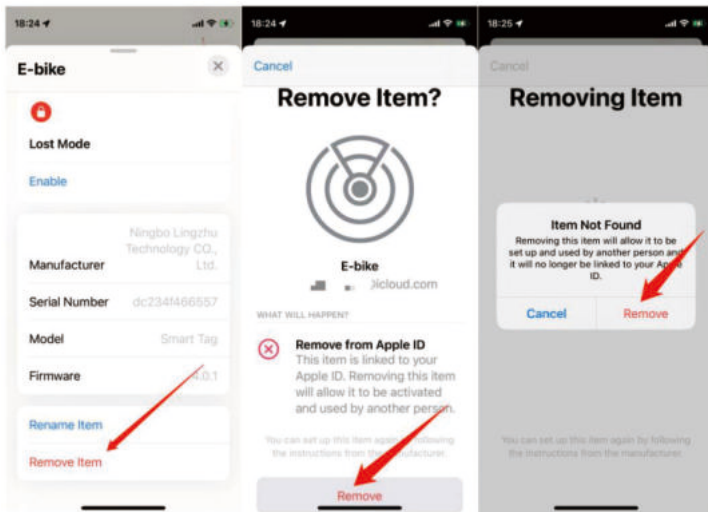

Re-power your display, After powering on for more than 40 seconds. Press and hold "+" for 15s and then release it to finish unbinding. Then use "Find My" again to search and verify if the unbinding is successful.

### H6 / H6 S Display

He H6 Max version has a 986 display, but the H6 and H6 S version use a 81F display. In terms of exterior durability, the 986 display and 81F display are essentially identical in what they offer. The important operation of 81F display can be found below.

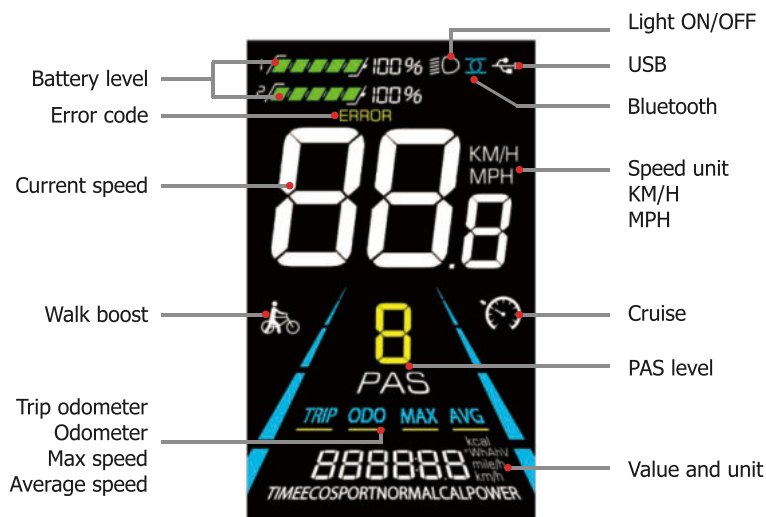

The main display shows speed, battery level, motor power, ODO, status, mode, run time, and trip information.

The two little blue arrows blinking on the top left of the screen is a communication flag. It indicates that all the electrical components are working normally.

### Operating Modes

Modes ① – ⑤ set the relative power (speed) level. Mode ⑥ disengages electric drive.

Electric power mode will be important when riding, as the modes determine the speed range for the bike at any particular time. Mode ① will drive the bike at a comfortably low speed, while mode ⑤ will power the bike up near the maximum available speed for electric assist.

Change the mode to the desired level when riding using the ⊕ and ⊖ buttons on the handlebar control.



PAS level display interface

### Trip Information

The multi-function side can show:

- ◆ ODO: total distance the bike has travelled
- ◆ MAX: maximum speed since trip odometer reset
- ◆ AVG: average speed since trip odometer reset
- ◆ TRIP: showing distance from the last time it was reset

## System Control

The electric power system and display are controlled with the handlebar control.

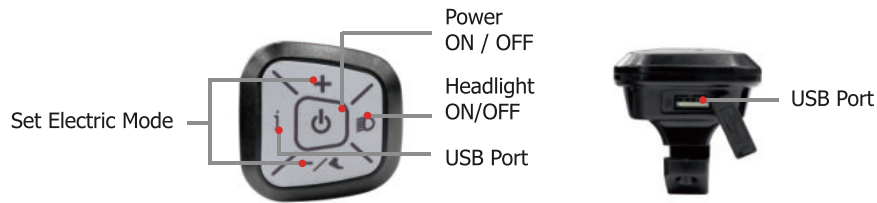

The ⊕ and ⊖ buttons set the electric power mode, and are also used in the settings panels.

The headlight button will switch the headlight on or off. (This system detects low light and will automatically switch on the headlight when needed.)

The ⏻ button powers up or powers down the electric system. (Press for 2 seconds to turn the system on or off.)

The ⓘ button cycles through the modes in the multi-function display.

Your H6/H6 S has an USB charging ports.

It is under the display panel.

## ADVANCED FEATURES

### Cruise Control

Your H6/H6 S has a cruise control capability. If enabled in Advanced Settings you can engage the cruise control by holding the bike at a constant speed for 5 seconds. When engaged, the bike will hold a steady speed until the brake is applied or the mode is changed.

For safety reasons, and because cruise control is not permitted in all jurisdictions, the feature is not enabled in the bike's default configuration. To enable the option, press the power and minus button at the same time until you see CRU icon on the screen(lower left quarter), you should now get the cruise to work.

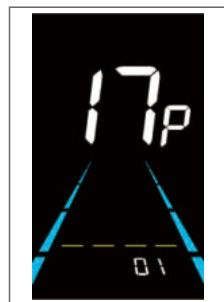

Controller cruise control setting interface

## Password Protection for the Electric Drive

You can set a password in your electric drive system so it cannot be started by an unauthorized person. (However the bike can still be driven by pedal without a password.)

PA is the power-on password setting. The power-on password is not activated by default but users can activate it from setting PSd-y. The factory default password is 1212. Users can set other four-digit password. Please keep the password in mind after changing it, otherwise you will not be able to use the display.



Power-on password OFF interface



Power-on password activated interface



Power-on password setting interface

### ● Setting Your Password

Set your password in the Display Menu as follows:

- 1) Press and hold both the ⊕ and ⊖ buttons to enter the parameter.
- 2) Use the ⊕ and ⊖ button to move down to Password.
- 3) With PSd-y highlighted, press the ⓘ button.
- 4) Press the ⓘ button to select it.
- 5) Set each of the 4 digits using ⊕ or ⊖, and ⓘ to select it.

◆ **Note:** Press to enter the parameter changing state. Press the / to select the parameter.

### Walking Your Bike

Long Press and hold ⊖ . the electric bicycle enters the walk boost mode. The electric bicycle will walk at a fixed speed of 6 km per hour and the display shows 🚲 . Release ⊖ to stop the power output immediately and restore to the state before walk boost.

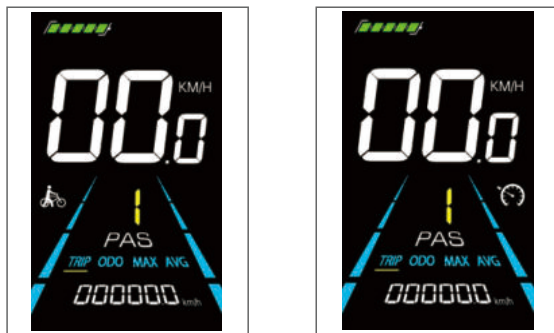

Helping to implement the display screen

◆ **Note:** The walk boost mode can only be used when pushing the electric bicycle, please do not use it while riding.

### Using The Headlight

The bike headlight can be operated by momentarily pressing the headlight button.

When the headlight is on, the display will be dimmed from the bright daytime level to a dimmer low-light level, and the headlight indicator will show on the display.



Headlight display interface

### Display Interface Switching

When the display is powered on, it will show the Current Speed (km/h) and Odometer (km) by default. Short press ① to switch between Odometer (km), Trip Odometer(km), Maximum Speed (km/h), and Average Speed (km/h).

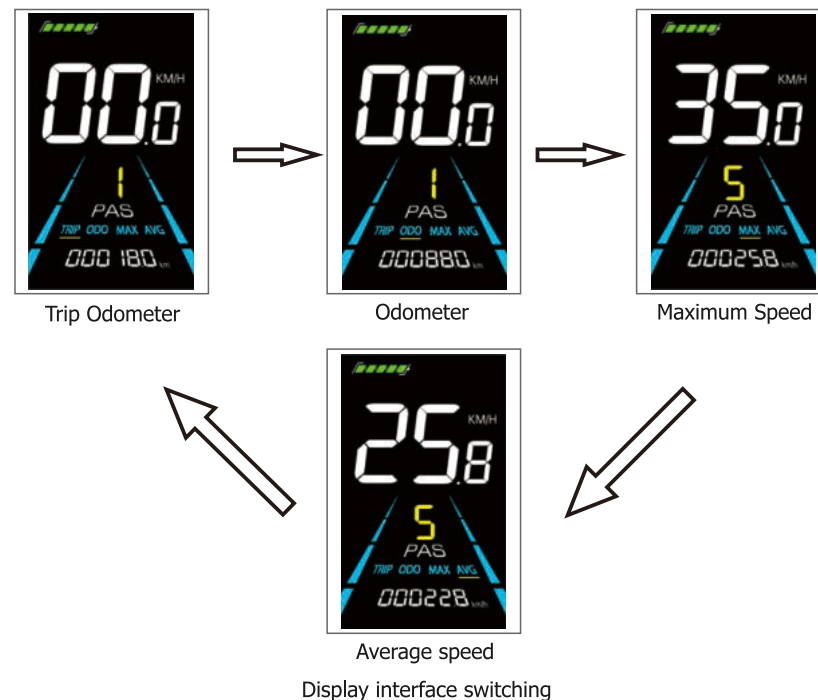

Display interface switching

### Battery level display

The Battery level is shown as 5 bars. When the battery is full charged, all of the 5 bars lighten up. When the battery is fully depleted, the bar will begin to flash, warning the user to charge the battery as soon as possible.

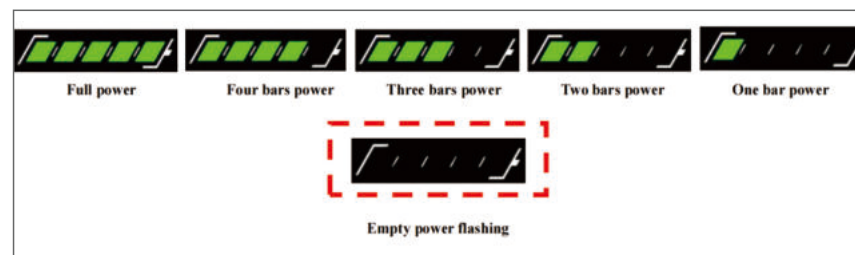

Battery level display interface

### Error Code Display

If there is a fault occurs in the electronic system of the electric bicycle, the display will automatically show an error code, see Schedule 1 for a detailed definition of the error code.

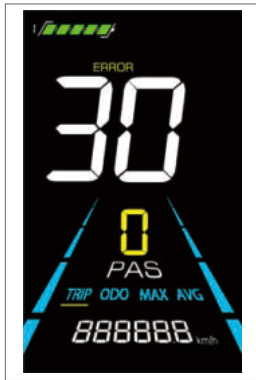

Error code display

◆ **Note:** When the error code appears on the display, please contact us for help, the electric bicycle will not be able to drive normally after the problem occurs.

### Backlight luminance setting

01P is the backlight luminance setting. Parameters 01, 02 and 03 are available, which represent the backlight luminance, 01 for the minimum luminance, 02 for the standard luminance and 03 for the maximum luminance.

Press the button ① to enter the parameter modification interface. Press the button ⊕ / ⊖ for parameter selection. Press the button ① to save the parameter and return to the selection interface of general setting options.



Backlight Luminance Setting Interface

### Metric and Imperial Setting

02P is the metric and imperial setting, 00 for metric and 01 for imperial.

Press ① to enter the parameter changing state. Press the ⊕ / ⊖ to select the parameter and press ① to save the parameter setting and return to the personalized parameter setting interface.

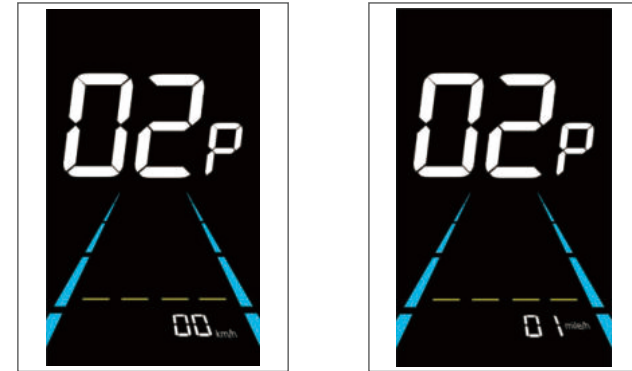

Metric and Imperial Units Setting Interface

### Rated Voltage Setting

03P is the rated voltage setting. The available rated voltage range is: 24V, 36V, 48V.

Press ① to enter the parameter changing state. Press the ⊕ / ⊖ to select the parameter and press ① to save the parameter setting and return to the personalized parameter setting interface.

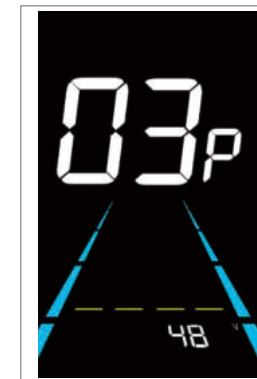

Rated voltage setting interface

## Auto Sleep Time Setting

04P is the auto sleep time setting. To save the battery power and reach higher range, this display will be turned off after it has not been used for a time. The adjustable range is: 1~60min, 00 means no auto shutdown. The factory default setting is 10 minutes.

Press ① to enter the parameter changing state. Press the ⊕ / ⊖ to select the parameter and press ① to save the parameter setting and return to the personalized parameter setting interface.



Auto Power Off Time Setting Interface

## PAS Level Setting

05P is the Pedal assist level setting. The available PAS level settings are: 0~3, 1~3, 0~5, 1~5, 1~7, 0~7, 0~9, 1~9.

Press ① to enter the parameter changing state. Press the ⊕ / ⊖ to select the parameter and press ① to save the parameter setting and return to the personalized parameter setting interface.



PAS level setting interface

## Wheel Diameter Setting

06P is the wheel diameter setting. The adjustable wheel diameter range is: 1~50inch.

Press ① to enter the parameter changing state. Press the ⊕ / ⊖ to select the parameter and press ① to save the parameter setting and return to the personalized parameter setting interface.

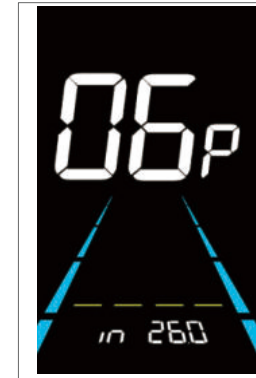

Wheel diameter setting interface

## Number of speed sensor magnets setting

07P is the speed sensor magnet number setting. The adjustable speed sensor magnet number range is: 1 ~ 255 pcs.

Press ① to enter the parameter changing state. Press the ⊕ / ⊖ to select the parameter and press ① to save the parameter setting and return to the personalized parameter setting interface.

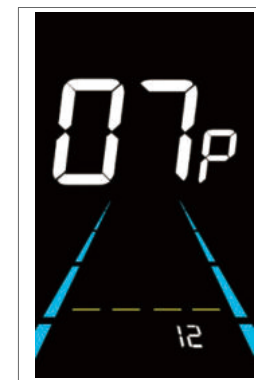

Number of speed sensor magnets setting interface



## Speed Limit Setting

08P is the speed limit setting. The adjustable speed limit range is: 1~100km/h. (The maximum adjustable speed limit varies by different protocols).

Press ① to enter the parameter changing state. Press the ⊕ / ⊖ to select the parameter and press ① to save the parameter setting and return to the personalized parameter setting interface.

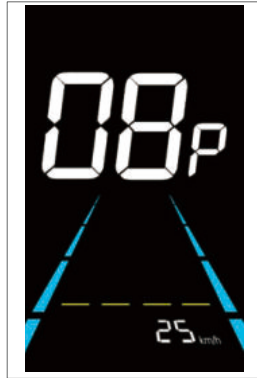

Speed limit setting interface

## Drive mode setting

10P is the drive mode setting. The available drive modes are: 00→Pedal assist only, 01→Electric only, 02→Both Pedal assist and electric.

Press ① to enter the parameter changing state. Press the ⊕ / ⊖ to select the parameter and press ① to save the parameter setting and return to the personalized parameter setting interface.

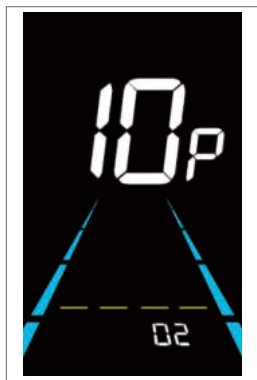

Drive mode setting interface

## Pedal assist sensitivity setting

11P is the pedal assist sensitivity setting. When set to higher numbers, it will take more crank rotations to activate the motor. On lower numbers, it will take little crank rotation to activate the motor. The adjustable range is: 1~24.

Press ① to enter the parameter changing state. Press the ⊕ / ⊖ to select the parameter and press ① to save the parameter setting and return to the personalized parameter setting interface.

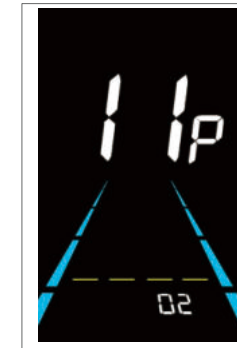

Pedal assist sensitivity setting interface

## Pedal assist strength setting

12P is the Pedal assist strength setting. The Pedal assist strength is the relative strength of the PWM signal from the controller when start to activate pedal assist. The adjustable range is 0 ~ 5. 0 is the weakest strength and 5 is the strongest.

Press ① to enter the parameter changing state. Press the ⊕ / ⊖ to select the parameter and press ① to save the parameter setting and return to the personalized parameter setting interface.



Pedal assist Start-up intensity setting interface

## Controller Current Limit Setting

14P is the controller current limit setting. The adjustable range is: 1~50A.

Press ① to enter the parameter changing state. Press the ⊕ / ⊖ to select the parameter and press ① to save the parameter setting and return to the personalized parameter setting interface.

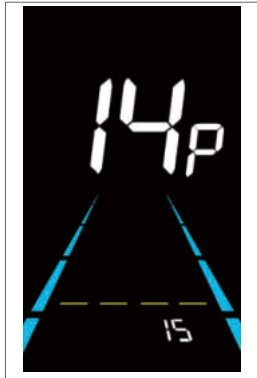

Controller current limit setting interface

## ODO resets setting

16P is the ODO resets setting. The display can choose the following: 00→non reset, 01→reset.

Press ① to enter the parameter changing state. Press the ⊕ / ⊖ to select the parameter and press ① to save the parameter setting and return to the personalized parameter setting interface.

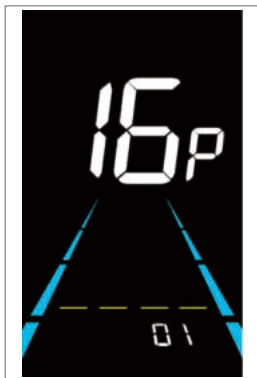

ODO resets setting interface

## Controller cruise control setting

17P is the controller cruise control setting. The display can choose the following: 00→non enable, 01→enable.

Press ① to enter the parameter changing state. Press the ⊕ / ⊖ to select the parameter and press ① to save the parameter setting and return to the personalized parameter setting interface.



Controller cruise control setting interface

## 6km/h walk boost setting

18P is the 6km/h walk boost setting. The display can choose the following: 00→turn off walk boost function, 01→turn on walk boost function.



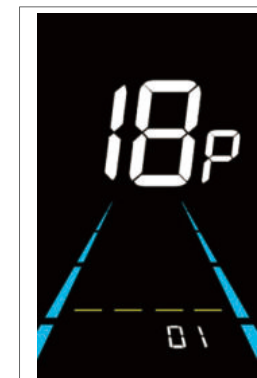

Press ① to enter the parameter changing state. Press the ⊕ / ⊖ to select the parameter and press ① to save the parameter setting and return to the personalized parameter setting interface.



6km/h walk boost setting interface

## Restore factory settings operation

dEF is the restore factory default parameter settings. dEF-Y is to restore default settings, and dEF-N is not to restore.

Enter into the main setting interface and keep the speed at 0, press and hold  and  simultaneously for 2s to enter the restore factory default setting interface. Pressing  /  to toggle to dEF-Y. Then after pressing  to confirm, the display will show dEF-0 for a few seconds and then automatically start to restore the factory default settings. The display will automatically exit to setting interface after the restoration.

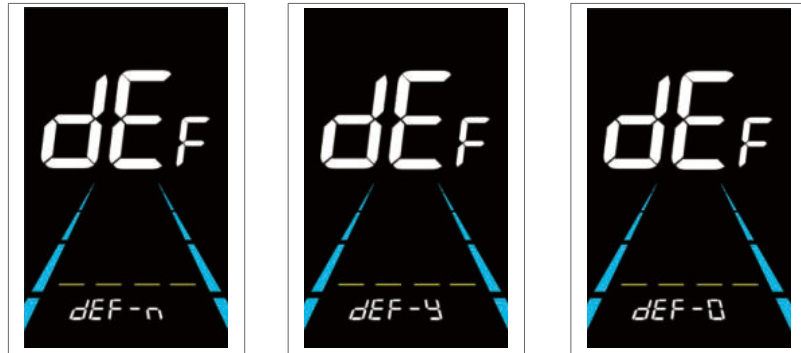

Restore Factory Default Settings Interface

## Trip odometer reset operation

The display can record trip odometer and odometer. Trip odometer is not automatically reset after turning off. The trip odometer needs to be reset manually.

Enter into the main setting interface and keep the speed at 0, press and hold and simultaneously for 2s to reset the trip odometer. The main interface will flash during the reset process.

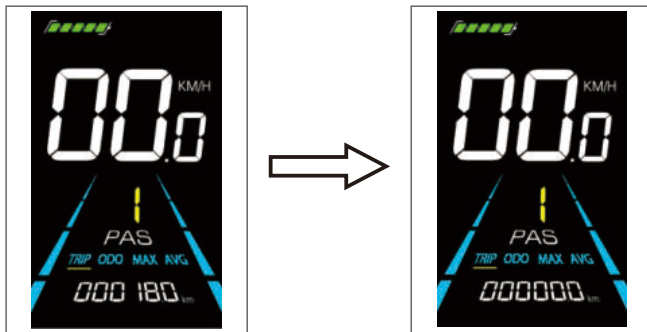

Trip Odometer Reset Interface

## CARE & MAINTENANCE FOR YOUR NEW E-BIKE

You should in general, take care of your e-bike the way you would with a regular bicycle by keeping it dry, clean and the moving parts well lubricated. You should also avoid parking your e-bike in exposed areas whenever possible.

### ● For Your E-Bike, You Should Also Take Note Of The Following:

- ◆ Your e-bike is designed for regular country road use for a single person. Using your e-bike for extreme maneuvers, such as extreme off-road use, jumping, or carrying the excessive load will damage the e-bike and could cause serious injury.
- ◆ Do not use high-pressure water streams to clean your e-bike, as water might seep inside the motor or the wiring compartment and cause rusting of electrical parts or short circuits.
- ◆ Avoid parking your e-bike outside when there is rain or snow. At the end of a trip where there was rain or snow, bring the e-bike inside and use a clean, dry towel to eliminate any wetness.

### ● Battery Maintenance

- ◆ Use only the supplied charger to charge your battery. Do not use an unauthorized substitute. If your charger is lost or damaged, contact us to order a replacement.
- ◆ Do not open or alter the battery or the battery charger.
- ◆ Do not place the battery near fire or corrosive substances. Do not immerse in water or other liquids.
- ◆ Avoid subjecting the battery from high temperatures, such as directly under the hot sun, for prolonged periods of time.
- ◆ Do not connect (short circuit) the two poles of the battery.
- ◆ After much use, your battery's charge holding capacity will decrease. If you find that your battery does not hold sufficient charge even for short trips, you should contact us to order a replacement. Under normal use, the battery will undergo 1000 charging and discharging cycles.
- ◆ If the battery will not be used for an extended period of time, charge it fully and recharge it every 1 months. Store it in a cool place.
- ◆ Your e-bike battery is engineered with precision for high capacity and long useful life. We do not recommend that you use it to power other electrical devices. Improper use of the battery will damage the battery and shorten its useful life and may cause a fire or an explosion.

## ● Motor Maintenance

- ◆ Please check your motor frequently and tighten any loose screws or nuts, to prevent the vehicle from breaking down due to disconnected wires.
- ◆ The brushless motors are not waterproof, so avoid riding through water deeper than the lower edge of the electric wheel hub to avoid motor failure.

## ● Brake Maintenance

- ◆ Simply check the alignment of the pads with the disc, and check that the wheel is fully pushed back. Good alignment ensures the absence of noise and a normal wear of the pads.
- ◆ Regularly check the condition of your cables, ducts or harness and the wear of your pads.

## Derailleur Maintenance

If shifting operation becomes less smooth. Clean the front derailleur and lubricate the link sections shown in the illustration. If gear shifting operations cannot be carried out smoothly. Clean the derailleur and lubricate all moving parts. If the amount of looseness in the links are so great, you should replace a derailleur.

## Transmission System Maintenance

The most effective way is to add lubricant. We should remind everyone that the chain should always be kept oily and sensitive, especially after wading and raining. The active parts of the front and rear derailleur must also be frequently filled with oil. The oil used for the chain and the derailleur should preferably be a rust-proof lubricant designed for bicycles. Ordinary engine oil can also be used, but the effect will be poor. If the chain is rusty, you can first wipe the rust spots with a kitchen cleaner, then clean the chain, and then wash it in diesel to restore the mountain bike chain as before.

## Lubricity

When you feel the chain is a bit stuck. In order to give you a better riding experience, lubricate the chain such that there's little noise. Keep the chain at work so that it can be smooth and unimpeded to ensure the operation of the bike. Intervals between maintenance depend on the use and riding circumstances.

## Handlebar

Before riding, please make sure that the handlebar is correctly installed in accordance with the video installation steps. Regularly check whether the handlebar firmware is stable. If there is any looseness, temporarily stop riding and install the installation steps to check and reinstall.

Always check the condition of your bike before you ride in addition to having regular maintenance performed. If you are unsure of how to conduct a complete check of the condition of your bike before every ride, you should consult a certified, reputable bike mechanic for assistance.

## ● Before And After Each Ride

- ◆ Check the alignment of the wheels.
- ◆ Check the state of charge of the battery.
- ◆ Check that brakes function properly.
- ◆ Check tires for any punctures.
- ◆ Store the bike carefully in a clean and dry place.
- ◆ Check that your kickstand is tightly secured.
- ◆ Check for loose cables or wires that may be strained when turning the front wheel from left to right.

## ● For The Battery, You Should Also Take Note Of The Following:

Every 1 to 2 months, it is recommended that you check the following:

- ◆ Check that the handlebar and saddle post are correctly inserted and tightened.
- ◆ Check that the wheel hub mounting nuts are correctly tightened.
- ◆ Check that the wheel rims are not cracked and that no spokes are loose or broken.
- ◆ Check that the tires are not worn or cut.
- ◆ Check that the tires are correctly inflated.
- ◆ Check that the battery contacts on the frame are not dirty or oxidized.
- ◆ Check that the batteries are sufficiently charged.
- ◆ Check that the front and rear brakes are working correctly.
- ◆ Check that the cables are sufficiently greased, and that the brake pads are in good condition.
- ◆ Check that the frame welds are in good condition, and are free of corrosion or oxidation.

## ● Quarterly (Or About Every 750-1500 Miles)

- ◆ Check all items on the Monthly service list above.
- ◆ Check tire tread for excessive wear. Replace if necessary.
- ◆ Check that electrical connectors and cable housings are secured away from moving parts and are free from damage. Replace if necessary.
- ◆ Go into your local bike shop for a tune-up by a certified and reputable bike mechanic.

## SAFETY TIPS

### We Recommend The Following Safety-related Procedures:

- ◆ Wear a helmet.
- ◆ Ride in control at all times.
- ◆ Use lights and reflective gear in low light situations.
- ◆ Inspect your bike often — especially the brakes.
- ◆ Seek maintenance if there are any notable changes in bike performance.
- ◆ Know and observe the rules of the road before cycling. Bike users must follow all road rules.
- ◆ Ride defensively. To motorists, pedestrians, or even other cyclists, you are not as visible as you might think. Always watch for hazardous situations, and be ready to stop or take evasive action at all times. With the assistance of the electric motor, you may be travelling faster than drivers expect—beware of cars pulling out in front of you.
- ◆ Avoid road hazards. Watch for and avoid potholes, drain grates, railroad tracks, loose road material, and other hazards.
- ◆ Use both the front and the rear brakes together for best performance. Using ONLY the rear will significantly increase your stopping distance.

### E-Bike Road Safety

Always obey traffic laws including lights, signals, and road signs that apply to traditional cyclists, cars, and other vehicles. Stay in the appropriate lane, using bike lanes when available. Cyclists tend to break the speed limit and red light laws.

This will only put you at risk of an accident. And this is a higher risk than for cyclists because your e-bike can travel faster than traditional bicycles. Do not cycle on the sidewalk/pavements as it can put both you and pedestrians at risk;

Be wary of everyone. E-Bike company AXcess states (source) that cars will not always realize how fast you are going and may assume that you are exponentially slower than them. To avoid the risk of accidents, always allow cars to get their right of way first, and do not rush. Be patient and alert, especially at intersections and turns.

## Guide To Cycling At Night

Use Lights Properly: Riding bicycle at night require lights on both the front and rear of the bike.

For extra protection, wear a clip-on bike helmet light, or purchase a helmet with built-in LED lights. Light vests are easy-to-wear over clothing to allow drivers to see the cyclist from a greater distance and ensure that the vehicle will pass with enough clearance. Turn on any built-in lights setting out to ride.

## BATTERY SAFETY

These safety precautions are provided for your benefit to protect you and those around you. Please read and follow them carefully to avoid unnecessary injury, damage to the product, or damage to other property.

### Battery

**CAUTION**

■ Do not throw the battery into a fire. Do not overheat the battery.



■ Do not connect the battery to other appliances other than your battery.

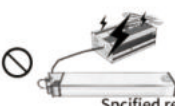

■ Use only the specified charger to charge the battery.



Specified rechargeable battery

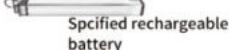

■ Do not take apart or modify the battery.



Disassembly Prohibited

■ Do not connect positive and negative terminals by using metallic objects.



(Electrolyte leakage, overheating and/or rupture may result in this type of abuse.)

### Battery Charger

**CAUTION**

■ Do not take apart or modify the charger



Disassembly Prohibited

■ Do not subject the charger to shocks, e.g. by dropping. Keep the charger away from water



■ Do not touch the charger with your skin for long periods during charging

Burning of the skin may result, as external temperature of the charger during charging may become 40C-60C(104F-140F)

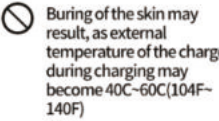

Overheating, fire or electric shock may result

■ Do not cover the charger or place objects on it

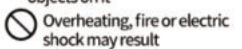

Overheating, fire or electric shock may result

■ Place the charger firmly on a flat dry surface

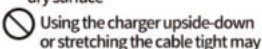

Using the charger upside-down or stretching the cable tight may result in malfunction, fire or electric shock

■ Do not short-circuit the terminals by using metallic objects

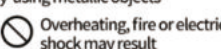

Overheating, fire or electric shock may result

**⚠ WARNING**

- Keep the battery away from water. Pouring water on the battery may result in short-circuit, overheating or permanent damage of the battery.
- Do not submerge the battery. Soaking the battery in water may cause irreparable damage.

**⚠ WARNING**

- Do not apply pressure to the cable or the plug.
- ⊘ Placing the cable tightened between a wall and a window frame, or placing heavy objects on the cord or the plug may result in electric shock or fire.
- Be sure to insert the plug securely into a wall socket.
- ⊘ Electric shock and overheating may result, causing fire.
- Do not touch the plug with wet hands.
- ⊘ Electric shock may result.
- Keep out of reach of children or pets.
- ⊘ Electric shock or injury may result.
- Do not attempt to use another maker or model's charger to charge the battery.
- ⊘ Overheating, fire or electric shock may result.
- Do not use the charging plug and/or the power source Plug when they are dirty, wet or dusty.
- ⊘ Insulation failure due to moisture absorbed in the dust may result, causing fire.
- Pull out the power source plug and clean it with a dry cloth.
- To remove a cable from a socket, pull the plug, not the cable.
- ⊘ Always pull the charging cable gently.
- Do not rotate the pedals when charging the battery while it is mounted on the bicycle.
- ⊘ The cord may twist around the pedal or the crank, and the damage to the plug may result, causing electric shock or fire.
- Do not apply voltage over the rated value to the charger.
- ⊘ Do not use sockets, correctors and other wiring devices with a power source other than standard rated voltage (AC110-240 volts) power supply.
  - Overheating, fire or electric shock may result.
- Do not use damaged components such as charge case, power cord, plug etc.
- ⊘ Electric short, short-circuit or fire may result.

Do not store the bike for more than 24 hours with an empty battery. This prevents a deep discharge with irreparable consequences from occurring.

Charge the battery and use the bike at least once every 30 days.

## H6 SPECIFICATIONS

Our bikes have a number of different traits, so it might not be possible to get every single attribute you want in the same model. Please find the specifications of our H6 as listed below.

Battery	48V 20AH lithium battery
Motor	48V 750W brushless motor
Maximum payload weight limit	350 lbs
Charging time	6-7 hours
Charger	US standard 48V 3A smart charger
Battery Charger Input Volt	110/220 volt AC
Battery Operational Temperature	0° to 40° Celsius (32° to 104° Fahrenheit)
Battery Life	Approximately 1000 complete charge/discharge cycles
Frame	20 inch aluminum alloy folding frame
Display	Full-color LCD display (with USB port)
Freewheel	Shimano 7 speed freewheel
Fork	20-inch alloy hydraulic shock absorption, adjustable and locked suspension fork
Brake	Double-disc hydraulic brakes
Transmission	Shimano 7 speed
Seat	Silicone seat
Tire	20 x 4.0 inch fat tires for mountain, snow, rain or muddy road
Pedal Sensor	Cadence Sensor
Fender	Included
Rear Rack	Included
Front LED Light	Included
Taillight	Included

The brand of parts advertised on our product page may vary depending on the ongoing supply chain constraints in the eBike market. Component changes may occur without prior notification. All parts have been carefully inspected to ensure they equal the performance standard of the products advertised.

## H6 S SPECIFICATIONS

Our bikes have a number of different traits, so it might not be possible to get every single attribute you want in the same model. Please find the specifications of our H6 S as listed below.

Battery	48V 20AH lithium battery
Motor	48V 750W brushless motor
Maximum payload weight limit	350 lbs
Charging time	6-7 hours
Charger	US standard 48V 3A smart charger
Battery Charger Input Volt	110/220 volt AC
Battery Operational Temperature	0° to 40° Celsius (32° to 104° Fahrenheit)
Battery Life	Approximately 1000 complete charge/discharge cycles
Frame	20 inch aluminum alloy folding frame
Display	Full-color LCD display (with USB port)
Freewheel	Shimano 7 speed freewheel
Fork	20-inch alloy hydraulic shock absorption, adjustable and locked suspension fork
Brake	Double-disc hydraulic brakes
Transmission	Shimano 7 speed
Seat	Silicone seat
Tire	20 x 4.0 inch fat tires for mountain, snow, rain or muddy road
Pedal Sensor	Cadence Sensor
Fender	Included
Rear Rack	Included
Front LED Light	Included
Taillight	Included

The brand of parts advertised on our product page may vary depending on the ongoing supply chain constraints in the eBike market. Component changes may occur without prior notification. All parts have been carefully inspected to ensure they equal the performance standard of the products advertised.

## H6 MAX SPECIFICATIONS

Our bikes have a number of different traits, so it might not be possible to get every single attribute you want in the same model. Please find the specifications of our H6 MAX as listed below.

Battery	48V 20AH lithium battery
Motor	48V 750W brushless motor
Maximum payload weight limit	350 lbs
Charging time	6-7 hours
Charger	US standard 48V 3A smart charger
Battery Charger Input Volt	110/220 volt AC
Battery Operational Temperature	0° to 40° Celsius (32° to 104° Fahrenheit)
Battery Life	Approximately 1000 complete charge/discharge cycles
Frame	20 inch aluminum alloy folding frame
Display	Full-color LCD display (with USB port, app and Apple Find My™)
Freewheel	Shimano 7 speed freewheel
Fork	20-inch alloy hydraulic shock absorption, adjustable and locked suspension fork
Brake	Double-disc hydraulic brakes
Transmission	Shimano 7 speed
Seat	Silicone seat
Tire	20 x 4.0 inch fat tires for mountain, snow, rain or muddy road
Pedal Sensor	Cadence Sensor
Fender	Included
Rear Rack	Included
Front LED Light	Included
Taillight	Included

The brand of parts advertised on our product page may vary depending on the ongoing supply chain constraints in the eBike market. Component changes may occur without prior notification. All parts have been carefully inspected to ensure they equal the performance standard of the products advertised.

## GENERAL TROUBLESHOOTING

As one or more causes of failure might lead to the failure phenomenon, you should find out the true cause(s) and then take the appropriate solution(s) to rectify the problem. In case of doubt, please consult a qualified technician for service, repairs or maintenance.

Phenomena	Possible Causes	Solutions
It doesn't work	<ol style="list-style-type: none"> <li>1. Insufficient battery power</li> <li>2. Faulty connections</li> <li>3. Battery not fully seated in tray</li> <li>4. Brakes are applied</li> <li>5. The bike will report a error code</li> </ol>	<ol style="list-style-type: none"> <li>1. Charge the battery</li> <li>2. Clean and repair display connectors</li> <li>3. Install battery correctly</li> <li>4. Disengage brakes</li> </ol>
Irregular acceleration and/or reduced top speed	<ol style="list-style-type: none"> <li>1. Insufficient battery power</li> <li>2. Loose or damaged throttle</li> </ol>	<ol style="list-style-type: none"> <li>1. Charge or replace battery</li> <li>2. Replace throttle</li> </ol>
When powered on, the motor does not respond	<ol style="list-style-type: none"> <li>1. Loose wiring</li> <li>2. Loose or damaged throttle</li> <li>3. Loose or damaged motor plug wire</li> <li>4. Damaged motor</li> <li>5. The bike will report a error code</li> </ol>	<ol style="list-style-type: none"> <li>1. Repair or reconnect</li> <li>2. Tighten or replace</li> <li>3. Secure or replace</li> <li>4. Repair or replace</li> </ol>
Reduced range	<ol style="list-style-type: none"> <li>1. Low tire pressure</li> <li>2. Low or faulty battery</li> <li>3. Driving with too many hills, headwind, braking and/or excessive load</li> <li>4. Battery discharged for long period of time without regular charges (aged or damaged)</li> <li>5.Brakes rubbing</li> </ol>	<ol style="list-style-type: none"> <li>1. Adjust tire pressure</li> <li>2. Check connections or charge battery</li> <li>3. Assist with pedals or adjust route</li> <li>4. Replace the battery</li> <li>5. Adjust the brakes</li> </ol>
The battery wont charge	<ol style="list-style-type: none"> <li>1. Charger not well connected</li> <li>2. Charger damaged</li> <li>3. Battery damaged</li> <li>4. Wiring damaged</li> </ol>	<ol style="list-style-type: none"> <li>1. Adjust the connections</li> <li>2. Repair or replace</li> <li>3. Battery Voltage Testing</li> </ol>
Wheel or motor makes strange noises	<ol style="list-style-type: none"> <li>1.Damaged motor bearings</li> <li>2. Damaged wheel spokes or rim</li> <li>3. Damaged motor wiring</li> <li>4. Disc not centered</li> </ol>	<ol style="list-style-type: none"> <li>1. Replace</li> <li>2. Repair or replace</li> <li>3. Repair or replace motor</li> <li>4. Adjust the brake or replacea</li> </ol>
Sensor Issue	<ol style="list-style-type: none"> <li>1. Sensor loose</li> <li>2. Sensor or cable broken damaged</li> </ol>	<ol style="list-style-type: none"> <li>1. Adjust the connections</li> <li>2. Repair or Replace</li> </ol>
Pre-load and turn off bike suddenly	<ol style="list-style-type: none"> <li>1. Battery or motor over heat protection</li> <li>2. Battery or controller cable loose</li> <li>3. Battery or controller cable damaged</li> </ol>	<ol style="list-style-type: none"> <li>1. wait 1-3 minutes to restart e-bike</li> <li>2. Adjust the connections</li> <li>3. Repair or Replace</li> </ol>

## ERROR CODES & TROUBLESHOOTING

In the event of a problem with the electrical components of your bike, the display will show an error code.

Compare the code with this list below and HOW TO RESOLVE:

CODE	ERROR	HOW TO RESOLVE
E001 / E03	Controller failure	The controller connection might be disconnected or damaged. Make sure it is free from grit or contaminants and is firmly connected. Service or replace the controller.
E004 / E02	Throttle Error	When you press and release the throttle, it should return to the original position. Remove any obstructions. Check the throttle and throttle cable for damage, such as a cut or frayed cable.
E006 / E05	Motor Phase Error	Check the cable that connects the rear hub motor to the rest of the system and make sure it is free from grit or contaminants and is firmly connected. This error might appear if you don't reconnect the cable after removing the rear wheel (for example, after changing a flat tire, or transporting your bike in the trunk of a car). At least one of the motor phase wires has been damaged or is temporarily disconnected.
E003 /E01	Hall failure	The hall sensor inside the rear hub might be disconnected or damaged. Service or replace the rear hub.
E005/E02	Brake Error	When you apply the brakes - built in "magnetic reed switches" disengage the motor's power when the lever is squeezed. If the lever is damaged (for example, following a crash), it might need to be replaced.
E002 / E30 /E07	Communication failure	Poor connection between the controller and the display, check all cable connections.



## Wallke E-Bike Warranty

Every Wallke E-bike is covered under our manufacturer's one year all-inclusive warranty for the original owner against all manufacturing defects.

Note: The warranty applies only to original owners and is not transferable.

## What About Warranty On Wallke?

Parts covered by the warranty: frame, forks, stem, handlebars, headset, seat post, saddle, brakes (excluding brake pads), lights, bottom bracket, crank set, pedals, rims, wheel hub, freewheel, cassette, derailleur, shifter, motor, throttle, controller, wiring harness, LCD display (excluding damage due to water), kickstand, reflectors, and hardware. The battery warranty does not include damage from power surges, use an improper charger, improper maintenance or other such misuse, normal wear, or water damage.

The warranty does not cover an incorrect assembly or installation of the product by the user; an improper or negligent use, operation or transformation of the product; a maintenance contrary to the maintenance instructions of the product (eg. lack of maintenance of the brakes); normal wear and tear; defects inherent to the normal useful life or service life of the product, such as a flat battery that can be replaced by the consumer; damages or defects due to accidents.

## Notes:

Failure caused by the following cases are not included in the warranty contents. However, the designated store or sales dealer has the responsibility and obligation to provide paid repair service:

- ◆ Without invoice and the warranty.
- ◆ Using and maintaining without complying with the user's manual.
- ◆ Using the electrical bicycle for other purposes or dangerous acts.
- ◆ Dismantling the parts without permission or improper use and storage.
- ◆ Without using the original parts.
- ◆ Traffic accidents or other accidents.
- ◆ Anti-rust layer damage caused by abnormal use, which leads to the corrosion and fracture of the parts.
- ◆ Riding on the abnormal road conditions.
- ◆ Commercial rental use.
- ◆ Irresistible natural disasters.

## Shipping Damage Claims

IMMEDIATELY inspect your product(s) for damage. Shipping damage must be reported to Wallke Ebikes within 7 days of shipment arrival. We will not accept Shipping Damage Claims later than 7 days from receipt of products.

## What Will We Do To Correct Problems With Your Bike?

If any component is deemed to be defective or damaged without user error, we will issue a replacement part and assist you in replacing the defective parts. We will replace any parts deemed to have been damaged during shipping.

## Contact Us

If your question has to do with your order, please include your order number and eBike serial numbers.

eBike serial numbers: Each bike has a serial number stamped on the bottom axis connecting the left crank arm.

Order ID: You can find this in the order history of the account the purchase was made through.

Please contact our service department at the below email. Please attach any relevant videos or photos showing your issue so the specialists can best assist you.

Please attention that Wallke electric bike has several sales channels now. Each sales channel has its order list and covers its own after service, including the warranty service, return service, and all.

Choose the right one to get connected! Or could not get the answers! If you've already submitted an inquiry, be assured that we are working diligently to respond (within 24 hours).

 **Wallke Ebike Website:** [www.wallkeebike.com](http://www.wallkeebike.com)

 **Website Service Email:** [sales@wallkeebike.com](mailto:sales@wallkeebike.com)

 **Amazon Service Email:** [info@wallkeebike.com](mailto:info@wallkeebike.com)

 **Phone:** 1-323-841-3459

- ◆ **Note:** If for some reason you didn't receive our reply email within 48 hours, please kindly check your spam folder.