

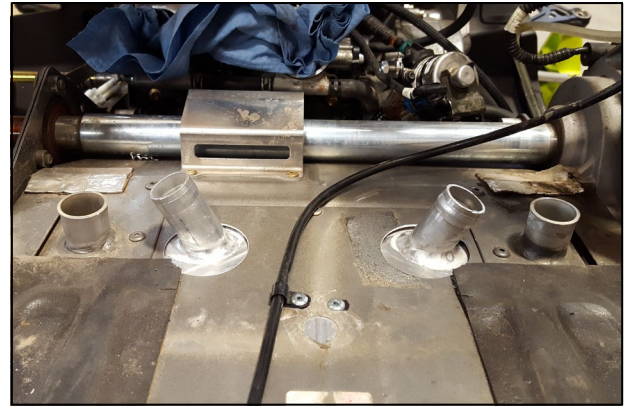

'18-Current Polaris AXYS 800 Intercooled Turbo Kit Install Instructions



1. Remove: side panel, hood, seat, fuel tank, muffler, coolant, inlet and outlet coolant hoses, coolant bottle, air intake, air box, right side frame brace, driven clutch and rear suspension. Use stock springs to double up Y-pipe to Pipe.



2. Place a rag in the intake of the throttle body and install the Tunnel Cooler. Mark location to drill holes for cooler fittings using template page as a guide. Remove taillight wiring guide making sure cooler will fit up flush with tunnel.

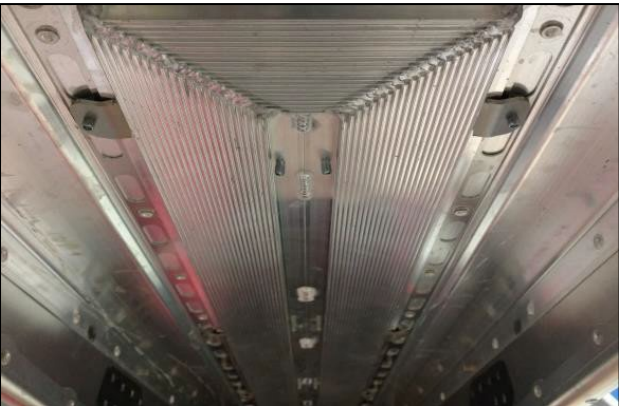

3. Center Cooler inside tunnel then rivet in place using the provided clamps securing the outer edge. Use original holes of the taillight guide to secure the center of the cooler. Place additional rivets in the rear flange on the cooler to secure.



4. Remove fuel rail, injectors, throttle body, throttle body adapter and mag (RH) reed cage. Mark and drill (using a 5/32 drill bit) a small hole in the reed cage. Tap hole to a 10-32 screw. Use super glue on threads, then install fitting.

MTNTKperformance.com



5. Cut tab off throttle body adapter on the right hand side to allow clearance for boost fitting.

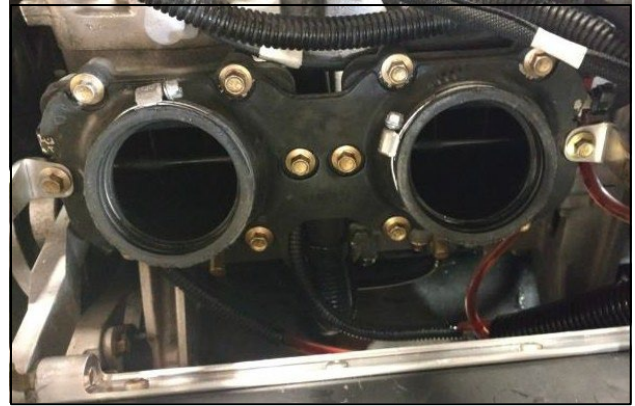

6. Reinstall reed cage and throttle body adapter. Install charge box spring brackets on either side.

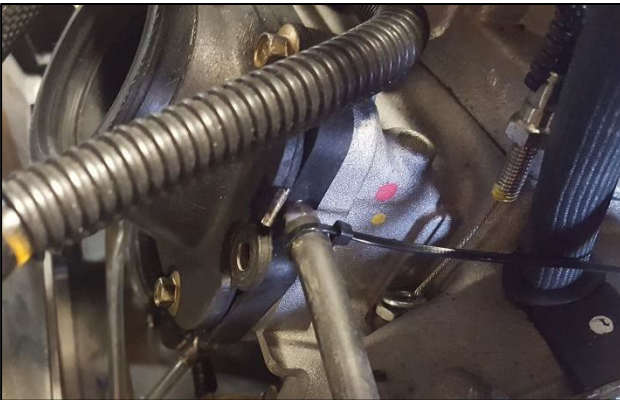

7. Install the 12" x 3/16" rubber hose onto the boost fitting you just installed and secure with a small zip tie. It will connect to the turbo recirculation valve later.

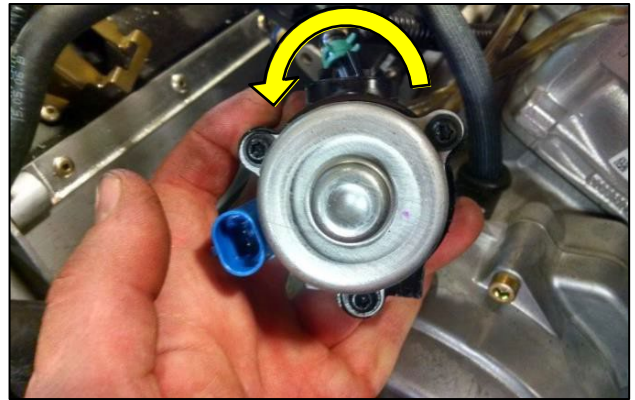

8. Cut zip tie and lift oil pump from bracket. Remove the 3 screws that hold it together. This will leak oil. Hold it together; rotate coil assembly counter-clockwise one hole as shown.



9. Re-install oil pump and place a zip tie as shown to hold it. Reroute wires along oil line.

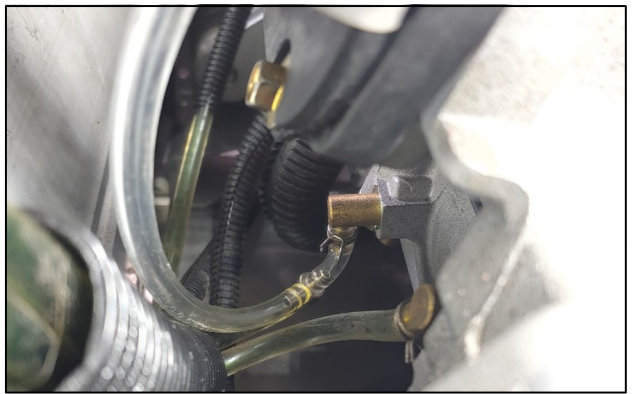

10. Remove MAG rod oil supply line from engine. Install supplied 'T' in-line. Route to the future turbocharger location.

MTNTKperformance.com



11. Re-install the throttle body. Carefully stretch the provided #27 O-rings then place in the groove of the throttle body inlets. Apply grease to both O-rings and Charge Box assembly.



12. Rotate water hose that exits the throttle body so the hose can supply the turbo with coolant. Slide Charge Box onto the throttle body. Use the stock clamps and lightly tighten.

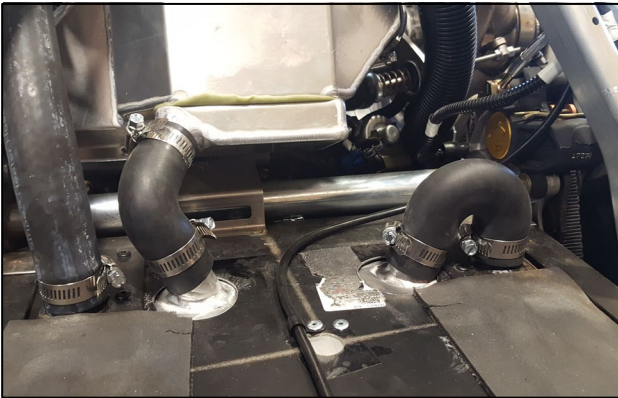

13. Install coolant hoses onto the Charge Box and lightly tighten hose clamps as shown. to both O-rings and Charge Box assembly.

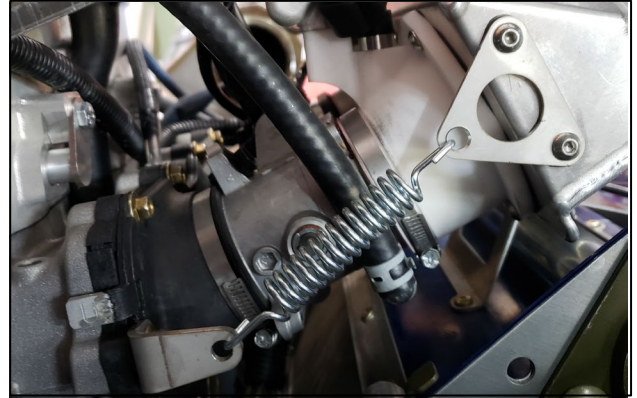

14. Place long charge box springs onto charge box and reed cage spring tabs as shown.



15. Mark and cut exhaust valve coolant line as shown. Install brass 'T' coolant line assembly.



16. Remove lower bulkhead bolt (this may require heat) and lay Backbone into place.

MTNTKperformance.com



17. Install Backbone using the torx 8mm bolt & stock nut. Use 8x35 bolt on top front, 8x30 bolt & 5/16 washer on bottom. Use original nut on bottom and original torx bolt on the rear.



18. Make sure the Backbone is installed on the correct side of the over structure as shown. Install the provided backbone/frame brace as shown.



19. REFER TO THE INJECTOR SPLICING PAGE.



20. Remove fuel line fittings. Replace with provided fittings. Leave loose for fitment (Step 23)

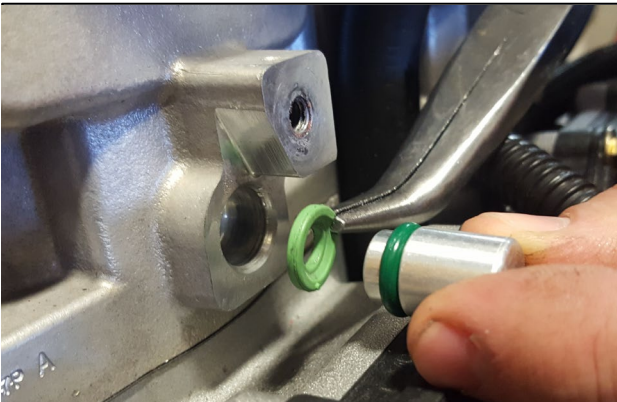

21. Remove injector O-ring from cylinder and install on injector hole block off plugs.

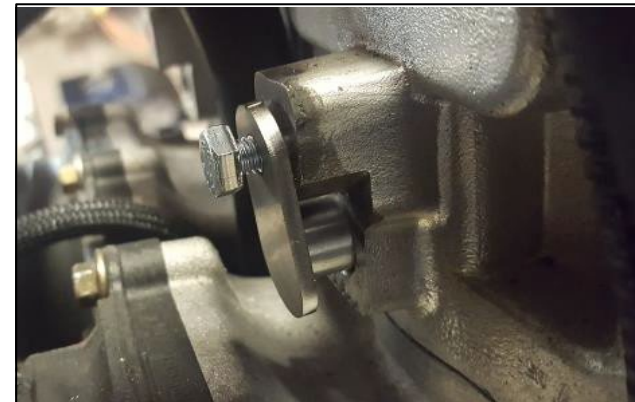

22. Install block off plug plates and supplied bolts. Make sure plate is lined up over plug.

MTNTKperformance.com

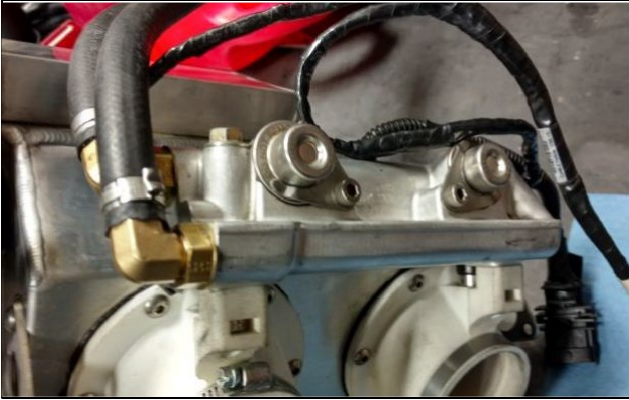

23. Lube injector O-rings, install injectors and rail onto the charge box. Use provided green O-ring and original bolts to install Fuel Rail. Apply Blue Thread Locker on bolts but do not over tighten.



24. Install fuel tank. Route fuel lines to the left side of the steering bracing. Ensure the line "snaps" down all the way. Secure these lines to the fuel rail with Oetiker clamps.



25. Remove coils and original coil wires by unscrewing them from the coils and plug caps. Re-install longer wires. Use zip ties to secure wire end caps. Bolt coils to relocation bracket.



26. Bolt bracket onto lower steering mount. Carefully route wires down the over structure. Be sure not to secure them too tight as they may become disconnected.

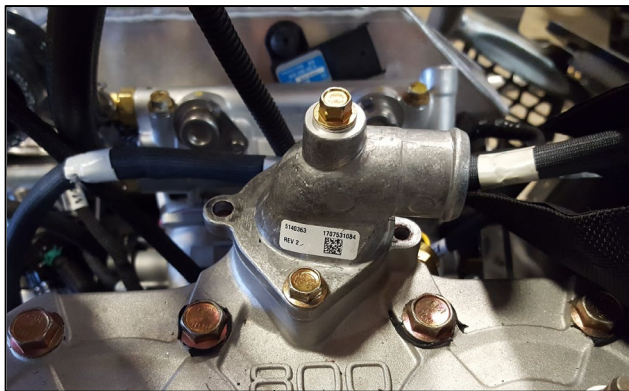

27. Rotate engine thermostat housing to exit towards the clutch side of the snowmobile.



28. Route the provided lower coolant hose under the recoil housing and up to the charge box.

MTNTKperformance.com



29. Install the upper hose from the cylinder head to the clutch side of the Tunnel Cooler as shown.



30. Remove fill screw from the bottom of the turbocharger and fill 3/4 to the top with 2-stroke oil. Apply thread sealant and tighten.

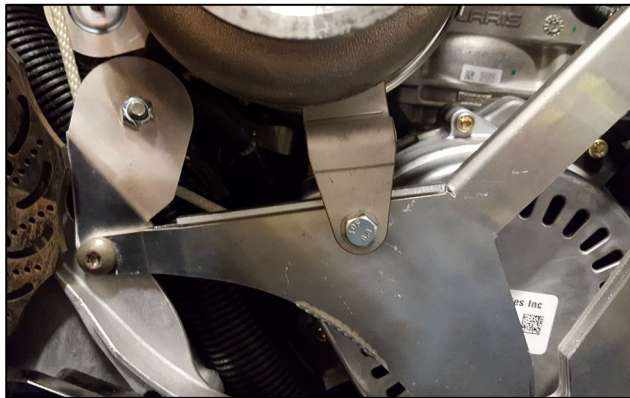

31. Use the provided charge hose, clamps, 8mm x25mm bolt and top lock nut to secure the turbo to the backbone and charge box.



32. Using the provided heavy duty springs, connect the exhaust inlet on the turbo to the exhaust pipe.



33. Connect the blow off valve/compressor recirculation hose from the reed cage fitting to the turbo.



34. Connect both water lines to turbo and secure them with the provided #4 hose clamps. Route Oil line as shown and install on turbo oil fitting

MTNTKperformance.com



35. Install turbo muffler by loosening the compressor housing and aligning the turbo to the muffler. Tighten V-band Clamp as shown.



36. Install the turbo intake hose and clamp with the 90 degree hose connected to the compressor housing. Leave loose for fitment.



37. Install air intake adapter to hood intake. This may need small adjustments for proper fit. Slide silicone intake over adapter. No clamp needed.



38. Install coolant reservoir hose as shown. Check all clamps and connections. Connect ECU and fill the system with coolant.



39. Install the provided clutching into the drive clutch. Be sure to torque clutch to 90 ft. lbs



40. Perform the download to the ECU. Refer to the GT instructions page to perform download to the sled.

MTNTKperformance.com

41. Start the engine. Run it at a high idle to help with bleeding the oil pump. The oil line should purge itself of air bubbles and will then be full of oil except for a small pocket of air that may stay at the very top before it enters the turbocharger. The coolant level will take several warm and cool down cycles to fully fill and stop purging air. This is normal since the cooling system is now more complicated. Peak operating rpm is 8400. If it is over this then turn the boost down by loosening the spring tension on the turbo.

Kit Contents:

Fuel Packet

- 2 - 90 Deg Barbed Fuel Rail Fittings
- 2 - Fuel Lines With Tank Fittings
- 4 - Oetiker Fuel Line Clamps

Turbocharger Assembly

Intake Adapter

Intake Hose

- 1 - 2.5" X 45 Deg Silicone Hose
- 1 - 2.5" X 90 Deg Silicone Hose
- 1 - 2.5" 16 Deg Aluminum Connector
- 3 - 52-76 Mm Hose Clamps

Muffler Assembly

Coolant Reservoir Assembly

Bully Dog GT Tuner

Hardware Packet

- 2 - Welded Reed Cage Spring Cams
- 2 - Charge Box Retention Springs
- 2 - #27 O-Rings
- 1 - 8mm X 35mm Bolt
- 1 - 5/16" (8mm) Washer
- 1 - 8mm Top Lock Nut
- 1 - Torx Head Bolt
- 1 - 8mm X 30mm Bolt
- 1 - 8mm X 25 Bolt
- 9 - #16 Worm Drive Hose Clamps
- 3 - 10-72 Clutch Weights
- Polaris Part Number 1322428
- 1 - 140-330 Drive Spring
- Polaris #7043829 (OR)
- 165-310 Polaris #7041988)
- 1 - 10" Velcro Strap
- 10 - Large Nylon Ties

Injector Packet

- 2 - Large Injectors w/Pigtails
- 4 - Quick Splice Connectors
- 2 - Green Injector Bushings
- 2 - Cylinder Injector Hole Block Off Clamps
- 2 - Cylinder Injector Hole Block Off Plugs
- 2 - 6mm X 10mm Bolts

Oil/Coolant Line Packet

- 1 - Reed Cage Boost Fitting
- 12" - 3/16" Rubber Hose
- 8 - 1/4" X 1/8" Oil Line Block Off Hose
- 1 - Turbo Oil Supply Line Assembly
- 1 - 1/4" Brass Coolant Tee Assembly
- 2 - Oetiker Coolant Clamps
- 2 - #4 Worm Drive Hose Clamps

Charge Box Assembly

- 1 - Map Sensor Extension Harness
- 1 - 45 Deg 2" Silicone Hose
- 1 - 90 Deg 1" Coolant Hose

Coolant Hoses

- 18.5" X 2.5" Engine Out (Upper) Hose
- 27.5" X 7.25" Engine In (Lower) Hose

Ignition Relocation Packet

- 2 - 24" Ignition Wires
- 1 - Coil Mount Assembly
- 4 - 6mm X 20mm Phillips Pan Head Screws
- 4 - 6mm Nylock Nuts
- 2 - 4" Zip Ties

Backbone/Frame Brace Assembly

- 5' Turbo Tunnel Cooler Assembly
- 8 - Clamp Plates
- 20 - Rivets
- 1 - 180 Deg Hose



The Tunnel Cooler Install Instructions



1. Remove rear suspension, track, seat, and fuel tank. Driveshaft & track removal not required but recommended. Remove left hand cooler hose and drain the cooling system. A clean shop vacuum set up for liquid works best.

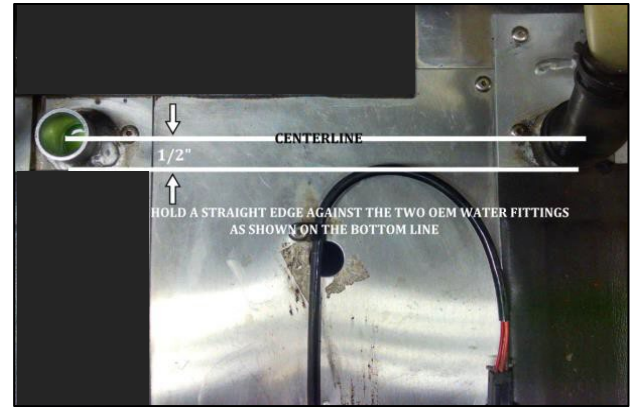

2. Use a straight edge to mark the OEM cooler fittings as shown. Measure up 1/2" and mark on both sides of the tunnel. Cut out attached template and lay between the OEM cooler extrusions. Center punch on each center marks.

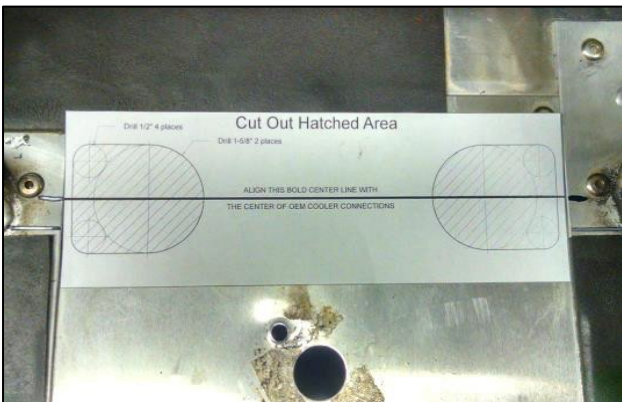

3. Drill a small pilot hole first then using an 1 3/4" hole saw, drill out the larger hole. Clean all shavings and rivet mandrels before continuing.

Look At Rivet Layout Sheet Before Proceeding



4. Use the taillight wire guide to mark new locations for the rivets down the center. This will ensure the correct location. Make sure the front is centered in the tunnel before marking. Insert Tunnel Cooler through the drilled holes.

MTNTKperformance.com



5. Secure the cooler with one rivet in the front and back. Align remaining rivets and secure. Rivet clamp plates under the tunnel as shown.



6. Use the Hose Cut Guide to cut the hose which comes off the cylinder head thermostat. Install and secure with hose clamps. ('11-'15 SEE STEP 7)



7. ('11-'15 ONLY) Insert splice and tighten hose clamps. Rotate and install onto the right hand cooler fitting with clamp. Secure with Zip Ties



8. Install 180° hose and clamps with the long leg on the new cooler fitting. Make sure clamps are tight. Reinstall gas tank, seat, and track.

9. Fill with coolant. We have found the best method is to raise the right side of the sled while filling. The OEM system holds just over 1 gal of coolant. You should use 1.5 gal on a 3' cooler and almost 2 gal on a 5' cooler. Run the engine and watch the temperature. The thermostat opens at approximately 120°F. It may take several attempts to fill the entire system.

Disclaimer: Make sure the fuel lines are connected properly or it may result in fire, injury or loss of life! Check for leaks upon first starting the engine! By installing this aftermarket accessory the owner assumes all liability for malfunction or incorrect installation.

Kit Contents:

- 1 - Cooler Assembly
- 4 - Hose Clamps
- 8 - Clamp Brackets
- 22 - 3/16" Steel Rivets
- 1 - 180° Silicone Hose
- 1 - Plastic Hose Splice ('11-'15 ONLY)

MTNTKperformance.com

| 950 W. 4th N. Saint Anthony, ID 83445 | P. 208-652-0122 | Email: orders@mtntkperformance.com |

5' COOLER RIVET LAYOUT

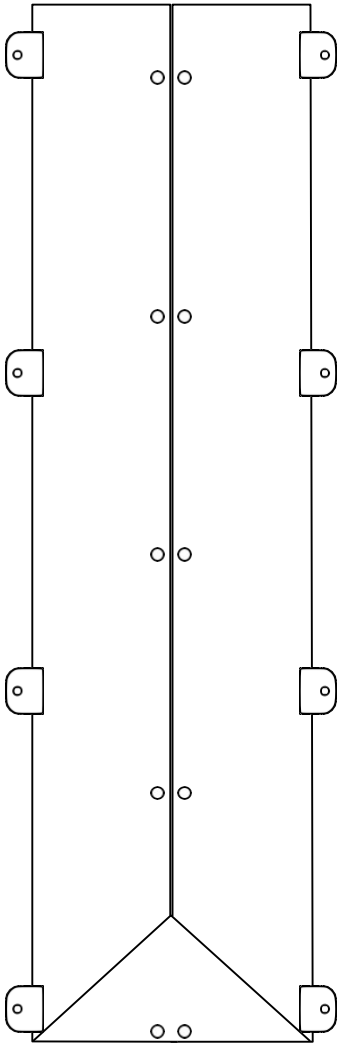

3' COOLER RIVET LAYOUT

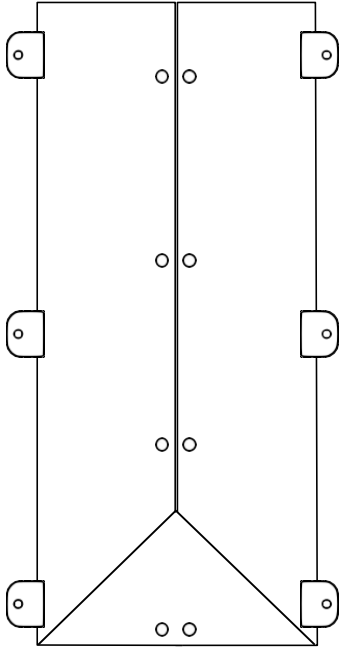

WHEN PRINTED TO ACTUAL SIZE - THIS DIMENSION SHOULD MEASURE 7-5/8"

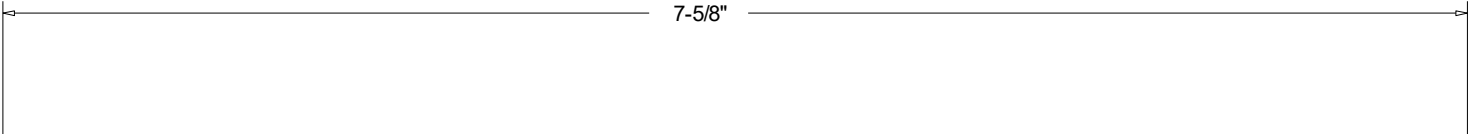

Cut Out Hatched Area

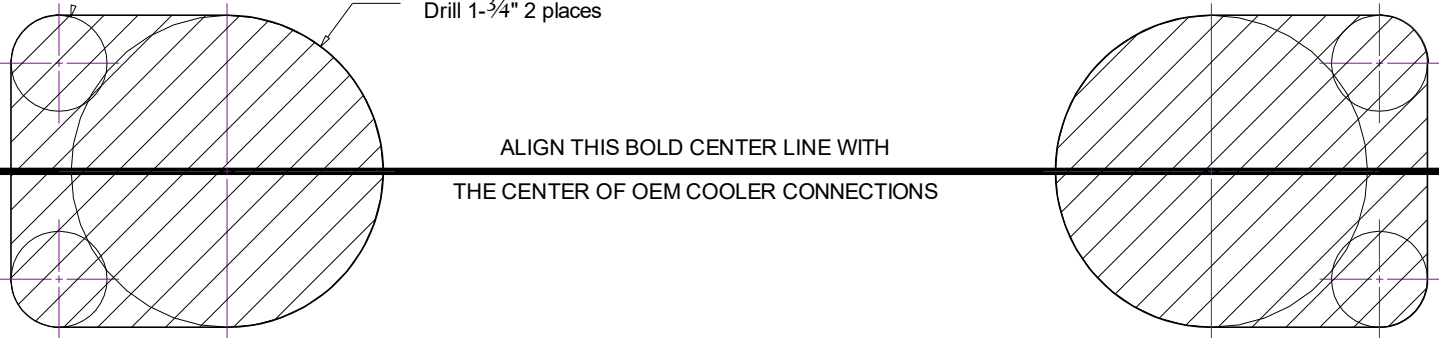



LARGE INJECTOR INSTALLATION NOTES

THIS IS NOT A CONCISE HOW-TO WORK ON YOUR SLED – MECHANICAL ABILITIES REQUIRED

DISASSEMBLY TIPS

- INSTALLATION OF INJECTORS DOES NOT REQUIRE REMOVAL OF THE TURBOCHARGER. REMOVE THE HOOD AND AIR INTAKE AND ACCESS CAN BE EASILY OBTAINED – TAKE NOTE OF WIRE ROUTING.
- WHEN REMOVING FUEL RAIL AND INJECTORS FROM CYLINDER BE AWARE OF SPILLING FUEL – TAKE APPROPRIATE FIRE PREVENTION MEASURES.
- WHEN REMOVING INJECTORS FROM CYLINDER THERE ARE GREEN RUBBER INJECTOR BUSHINGS (WASHERS) ON THE END OF THE INJECTORS – SOMETIMES THEY STAY ON THE INJECTOR – SOMETIMES THEY STAY IN THE CYLINDER – MOST OF THE TIME THEY DROP DOWN AND ARE NEVER SEEN AGAIN. TAKE THE TIME TO LOCATE THEM, THEY ARE REQUIRED AND IF YOU CANNOT FIND THEM THEY NEED REPLACED.

FIGURE 1 – INJECTOR DIAGRAM

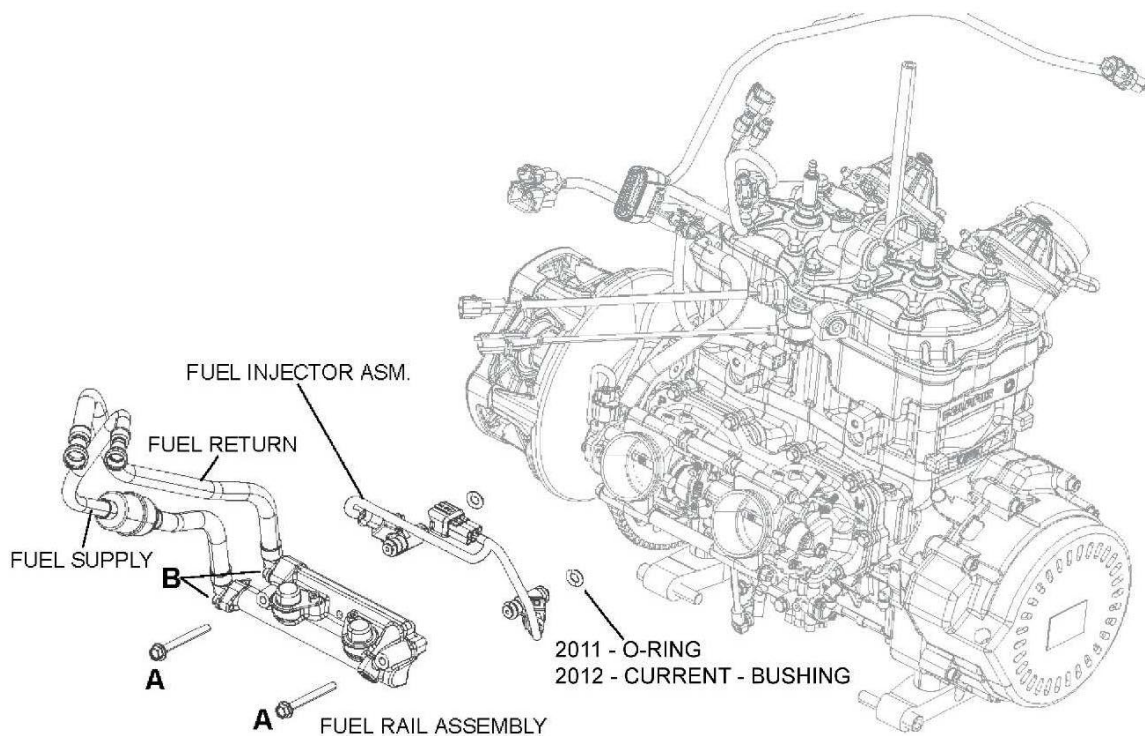

INJECTOR HARNESS MODIFICATION

- THE INJECTORS ARE GLUED ON FROM THE FACTORY AND IT IS DIFFICULT TO REMOVE THEM. PROVIDED IS A NEW INJECTOR CLIP CONNECTOR AND HEAT SHRINK SOLDER SLEEVE CONNECTORS TO REPLACE THE ENDS.
- REMOVE THE TAPE FROM EACH INJECTOR WIRE HARNESS AND LAY OUT ON A WORKBENCH. MAKE MARKS APPROXIMATELY 2" APART IN THE MIDDLE AND CUT THE INJECTOR OFF THE HARNESS LEAVING THE WIRE LONG. THE GOAL IS TO CUT THE TWO WIRES OFF STAGGERED AND THEN MATCH UP THE INJECTOR CLIP. SEE FIGURE.

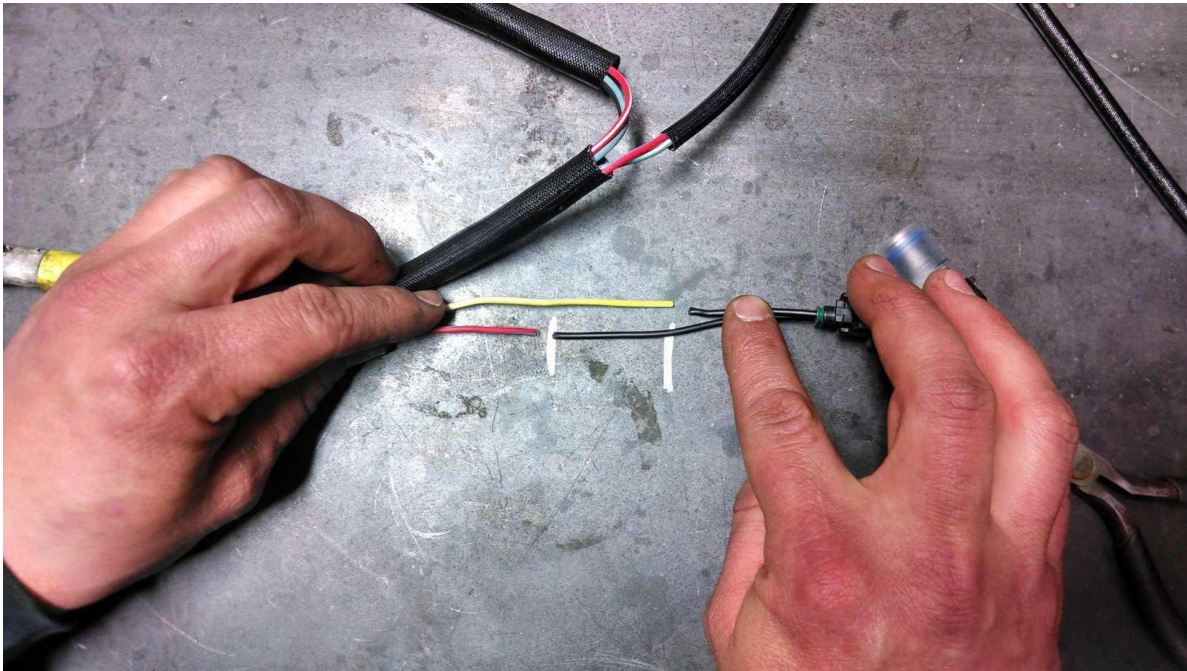

- STRIP THE WIRE ENDS AND CRIMP SOLDER SLEEVE CONNECTORS ONTO THE WIRES USING SUITABLE WIRE CRIMP PLIERS. PERFORM THIS TO BOTH INJECTOR PIGTAILS. THE INJECTORS ARE NOT POLARITY SENSITIVE SO IT DOES NOT MATTER WHICH WIRES YOU HOOK UP TO EACH OTHER.
- AFTER CRIMPING THE CONNECTOR ON USE A HEAT GUN (EVEN A \$15 ONE FROM ACE HARDWARE OR SIMILAR ON LOW HEAT WILL WORK) TO HEAT SHRINK THE CONNECTOR ON BOTH ENDS. DO NOT USE A FLAME TO HEAT THE CONNECTOR. ONCE THE ENDS HAVE SHRUNK DOWN THEN HOLD THE HEAT ON THE CENTER OF THE CONNECTOR AND THE SMALL BAND OF SOLDER IN THE MIDDLE WILL MELT AND YOU WILL SEE IT COLLAPSE AND SOLDER THE WIRES TOGETHER. LET COOL. IT SHOULD LOOK AS SHOWN.



- RE-TAPE UP THE WIRE HARNESS USING A GOOD QUALITY ELECTRICAL TAPE.

ASSEMBLY TIPS

- A SMALL AMOUNT OF GREASE OR SIMILAR LUBRICANT WILL HELP IF APPLIED TO THE O-RINGS – BUT DO NOT PUT AN EXCESSIVE AMOUNT THAT WILL GET INTO THE FUEL SIDE OF THE INJECTOR! IT WILL PLUG THE FINE FILTER INSIDE THE INJECTOR AND BEST CASE IT WILL PREVENT THE ENGINE FROM RUNNING, WORST CASE IT WILL AFFECT FUEL FLOW ONLY ENOUGH TO RUN LEAN AND CAUSE SERIOUS ENGINE DAMAGE.
- ENSURE ALL WIRES ARE NOT RUBBING AND ARE PROPERLY ROUTED AND SECURED WITH PLASTIC TIES.

Bully Dog Gauge Tuner Installation



*** ALL UPDATING AND TUNING IS TO BE DONE WITH ENGINE OFF ***

MOUNTING

*We do not at this time recommend installing the GT, HDMI Cable or the Adapter Module on the sled permanently. It has been shown to malfunction with water entry. We recommend installing it for display and diagnostic purposes only and then remove before normal riding.

- 1) Locate the diagnostic 8 pin connector with ONLY 4 WIRES PRESENT with the protective block off termination plug. This connector is located near the left hand front shock tower usually covered with a fabric cover secured by Velcro.
- 2) Connect the adapter module to the HDMI cable and determine cable routing length. Be mindful of keeping the module and cable away from heat, vibration, moving parts and especially water since it is not waterproof.
- 3) Connect the adapter to the diagnostic plug and secure such that wires will not move freely to prevent the delicate wires from breaking.
- 4) Ensure the 2 amp fuse is installed in the module and the switch is set to BAT(TERY).
- 5) Connect the GT (Gauge Tuner) to the other end of the HDMI cable. Completely fill the ends of the HDMI cable with dielectric grease and then insert it into the connector. It should insert fully about 1/4". If it does not go in very far look at the retaining fingers of the GT's HDMI port and ensure they will allow the cable to insert fully.
- 6) Mount the GT in a location that will allow access to the SD Card and will protect it from loss or damage. Or alternatively route the cable to a location that will allow the GT to be mounted easily for diagnostic purposes then when not in use you can tuck the end of the cable out of the way so it is not damaged. We have found the handlebar pad to be a good place to tuck the end of the cable into.
- 7) Secure the wires with zip-ties and mount the module either with zip-ties or with the provided Velcro. If cable length is sufficient it can be mounted on the clutch cover guard or the back side of the ECU. Ensure that the HDMI cable is not going to work its way out and be mindful of preventing water from draining directly onto the module.

*** ALL UPDATING AND TUNING IS TO BE DONE WITH ENGINE OFF ***

UPDATING AND PROGRAMING

Each individual ECU has a unique serial number, which is used by the GT to determine if your programing is valid for it. This ECU serial number must be provided to MTNTK Performance and a unique program generated for that serial number. A program used in one ECU cannot be used in another without a new program being generated for the new ECU's serial number.

An ECU obtained new from Polaris not previously installed onto an engine comes blank without programming and must be first programmed with the Polaris Digital Wrench software by an authorized Polaris Dealership. Programming with a GT will not work until an original Polaris file is loaded into the ECU first. Please contact MTNTK Performance if you have any questions. From time to time updates to the GT will be available and will require downloading.

UPDATE PROCEDURE and PROGRAMMING

- 1) GT UPDATE – If installing a new kit or GT then updating is recommended. If a file was emailed to you then download the file to a location you can remember where on your computer. GT update files will be a RMK.bin file for snowmobiles and RZR.bin for Polaris RZR's.
- 2) ENGINE PROGRAMMING - Engine Programming files will be up to 8 characters followed by .atv . for example (EXAMPLE - 13TP8283.atv).
- 3) Remove the SD card from the GT by pushing in and releasing. It should stick out enough to allow you to pull it out.
- 4) Insert the SD card into your computer using the provided SD card to USB adapter.
- 5) Open Windows Explorer and find the card.
- 6) Drag the RMK.bin file (only if you are updating the GT otherwise skip to step 7) from its location and drop onto the SD card NOT into any folders. It will say there is a file already named RMK.bin. Make the selection to REPLACE OR OVERWRITE the original.
- 7) If you downloaded an engine tuning file to install then look on the SD card for a folder named USER. If no folder exists on the card already with that name, make one using all capital letters named USER.
- 8) Drag the tuning file with the extension .atv INTO the USER folder. It is not required to remove old tuning files unless you desire.
- 9) Eject the card safely with the proper eject procedure before removing from the computer.
- 10) WITHOUT the engine running or the ECU powered up insert the SD card into the GT by pushing in fully and it will pop back up slightly when fully inserted.
- 11) Using the provided power up cable connect the white plug end to the ECU POWER plug located next to the diagnostic plug by the shock tower.
- 12) Using a GOOD 12 Volt 5series battery or larger connect the power up cable to the correct posts of the battery. Connecting battery backwards will destroy the ECU and GT and warranty will be void. The GT will beep once and then the start up splash screen will roll.
- 13) Using the capacitive touch buttons select GAUGE, then using the right hand buttons scroll one of the gauges until BATTERY VOLTAGE is displayed. Ensure that the voltage is over 12.1 volts. If not disconnect and find a suitable power source. Do not attempt using a battery charger while the GT is connected as it will have too much voltage and ECU damage will occur.
- 14) Select
 - a. MENU – scroll down
 - b. CHANGE VEHICLE/ENGINE
 - c. POLARIS
 - d. POLARIS-'10-'14 RMK (even if your sled is newer then select this for Polaris)

Device will then load an image file and reboot.

- 15) Once the GT has rebooted
 - a. Disconnect the power for 5 seconds
 - b. Reconnect the power
- 16) Select
 - a. MENU, and scroll down to
 - b. UPDATE DEVICE SOFTWARE
- 17) It will ask if you want to update with the POLARIS RMK.BIN FILE. Select YES. The screen will darken and the device will chirp for 5 seconds then reboot. Once rebooted disconnect the power to the power up cable for 5 seconds. Reconnect the power.

- 18) (TURBO ONLY) Select
 - a. MENU
 - b. USER OPTIONS
 - c. SELECT BARO
 - d. 3BAR
 - e. GO BACK until you are to the gauge screen
- 19) Make sure battery voltage is still above 12.1 volts
- 20) Select
 - a. MENU
 - b. TUNING
 - c. INSTALL CUSTOM TUNING (It may take up to 15 seconds for this to switch after selection. If it freezes then make sure your SD card is installed and then power cycle the device and start over.)
 - d. SCROLL DOWN AND AGREE you are the owner
 - e. Confirm that the engine is NOT running
 - f. DOWNLOAD CUSTOM TUNE TO VEHICLE
 - g. Scroll to the file you want and select NEXT
- 21) It will first import the file from the card and then download to the ECU. DO NOT DISTURB the battery, GT, or anything else until it is complete or ECU FAILURE could result.
- 22) Select
 - a. Finish
 - b. Remove power from the power up cable and wait 5 seconds
 - c. Connect power
- 23) Use this time to play with the settings and features of the GT. Press and hold the gauge button, three times and it will scroll through the different displays. Press and hold the right hand buttons and it will change from day to night mode. Change colors and themes in the USER SETTINGS.
- 24) Disconnect the power and remove power cable from sled. Install side panel.

*****INSTALLING A NEW TUNING FILE ONTO THE SD CARD AND DOWNLOADING TO THE ECU WITH A BULLY DOG GT (Gauge Tuner)*****

- 1) Drag the tuning file with the extension .atv INTO the USER folder. It is not required to remove old tuning files unless you desire.
- 2) Eject the card safely with the proper eject procedure before removing from the computer.
- 3) WITHOUT the engine running or the ECU powered up insert the SD card into the GT by pushing in fully and it will pop back up slightly when fully inserted.
- 4) Using the provided power up cable connect the white plug end to the ECU POWER plug located next to the diagnostic plug by the shock tower.
- 5) Using a GOOD 12 Volt 5series battery or larger connect the power up cable to the correct posts of the battery. Connecting battery backwards will destroy the ECU and GT and warranty will be void. The GT will beep once and then the start up splash screen will roll.
- 6) Using the capacitive touch buttons select GAUGE, then using the right hand buttons scroll one of the gauges until BATTERY VOLTAGE is displayed. Ensure that the voltage is over 12.1 volts. If not disconnect and find a suitable power source. Do not attempt using a battery charger while the GT is connected as it will have too much voltage and ECU damage will occur.
- 7) Select
 - a. MENU
 - b. TUNING
 - c. INSTALL CUSTOM TUNING (It may take up to 10 seconds for this to switch after selection. If it freezes then make sure your SD card is installed and then power cycle the device and start over.)
 - d. SCROLL DOWN AND AGREE you are the owner
 - e. Confirm that the engine is NOT running
 - f. DOWNLOAD CUSTOM TUNE TO VEHICLE
 - g. Scroll to the file you want and select NEXT
- 8) It will first import the file from the card and then download to the ECU. DO NOT DISTURB the battery, GT, or anything else until it is complete or ECU FAILURE could result.
- 9) Select
 - a. Finish
 - b. Remove power from the power up cable and wait 5 seconds
 - c. Connect power for 5 seconds. You can now remove the power and start the snowmobile.